

# Military 20-Pin PAL Devices

## Features

- Register and combinatorial outputs
- Variety of speed/power options
- Registers with feedback
- Programmable three-state outputs
- Security fuse prevents duplication of logic
- Through-hole or surface mount device packaging
- Neutron fluence (permanent damage):  $1 \times 10^{13}$  N/cm<sup>2</sup>
- Dose rate (transient upset) junction Isolated Bipolar processes:  $2 \times 10^{18}$  RADs (SI) per sec recovered in 50 to 70  $\mu$ s from a 1  $\mu$ s pulse

## Benefits

- Instant prototyping/zero NRE charge
- Low-cost programmable replacement for TTL logic
- Reduces inventory by reducing chip count
- Programmable on standard PROM/PAL device programmers
- Several software programs available to assist in creating bit pattern design

## Applications

- High speed graphic controllers
- High speed computers
- High frequency state machines
- High frequency counters
- Microprocessor clock generation and Interface logic

20-Pin PAL Device Speed vs Power

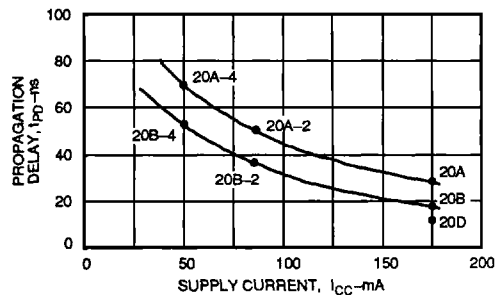

503 102

# Military 20-Pin PAL Device Pinouts

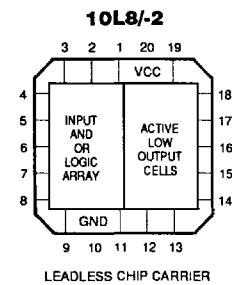
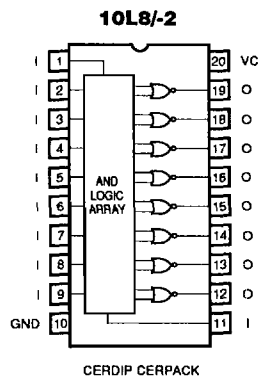
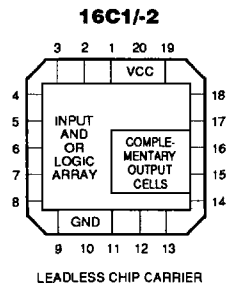
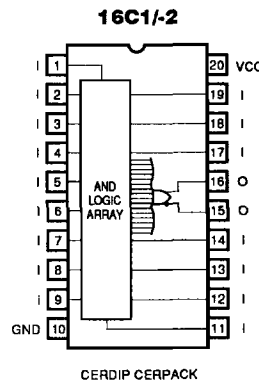
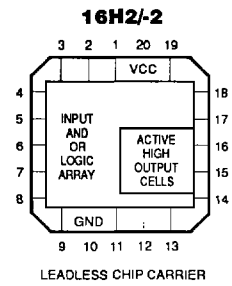
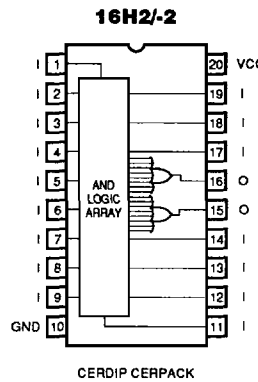
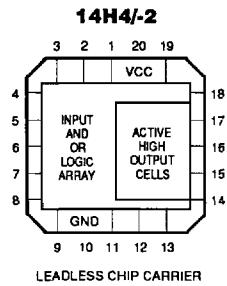
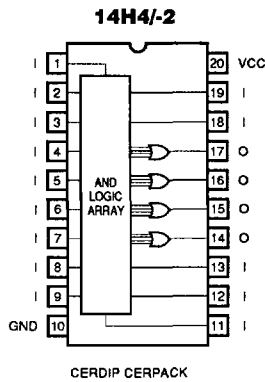
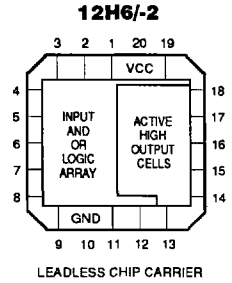
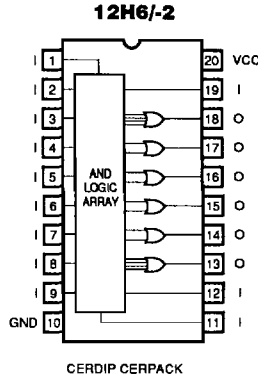
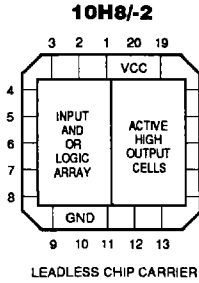
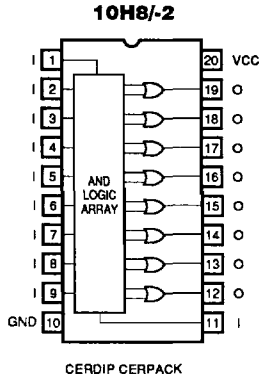

503 103

# Military 20-Pin PAL Device Pinouts

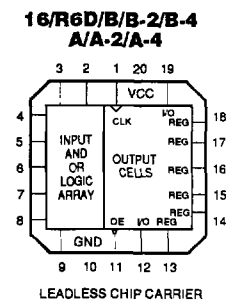
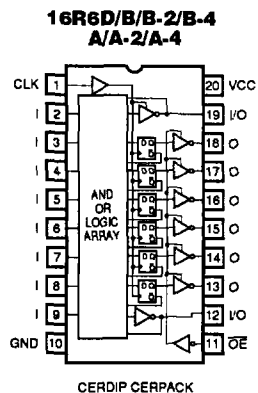
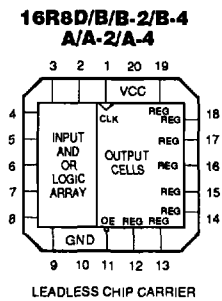
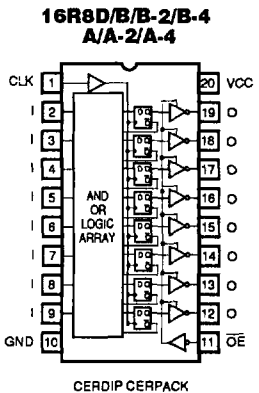
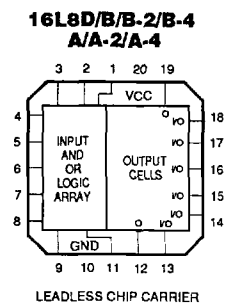
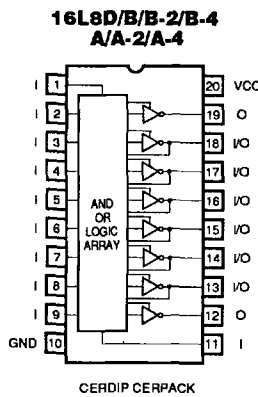
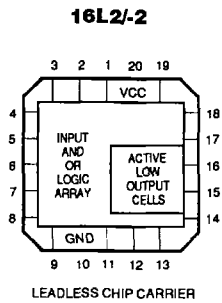
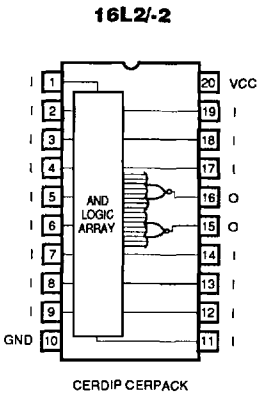
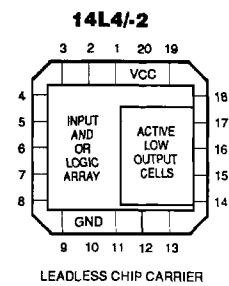
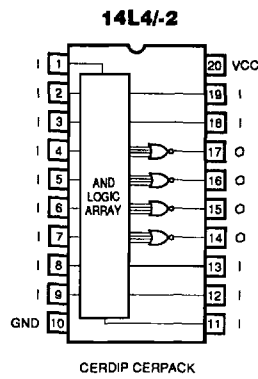
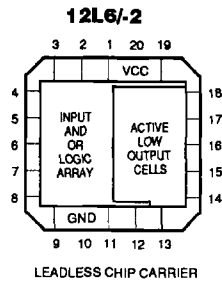
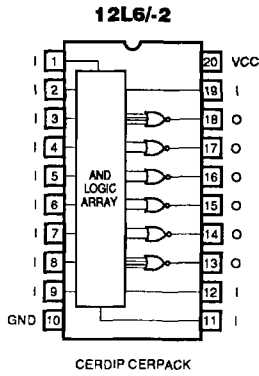

5

503 115

# Military 20-Pin PAL Device Pinouts

**16R4D/B/B-2/B-4  
A/A-2/A-4**

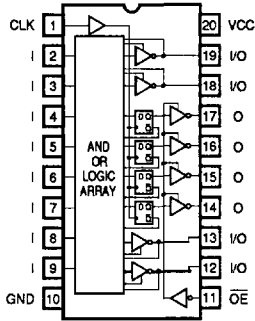

CERDIP CERPACK

**16R4D/B/B-2/B-4  
A/A-2/A-4**

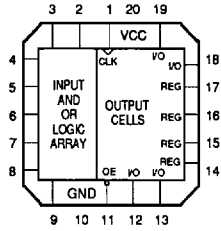

LEADLESS CHIP CARRIER

**16X4**

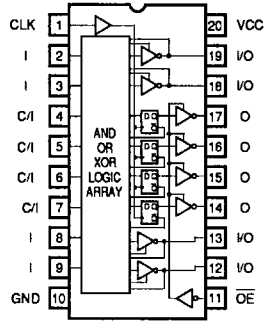

CERDIP CERPACK

**16X4**

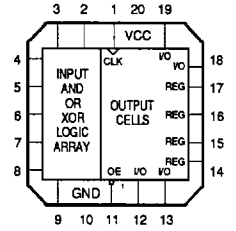

LEADLESS CHIP CARRIER

503 127

## Military 20-Pin PAL Devices

### Absolute Maximum Ratings

	Operating
Supply voltage, VCC .....	-0.5 V to 7 V
Input voltage range .....	-1.5 V to 5.5 V
Off-state output voltage .....	5.5 V
Storage temperature .....	-65°C to +150°C
Maximum junction temperature ( $T_j$ ) .....	175°C
Lead temperature (soldering, 10 sec max) .....	300°C
Maximum current density $5 \times 10^{-8}$ A/cm <sup>2</sup> per Mil-M-38510 .....	$< 5 \times 10^{-8}$ A/cm <sup>2</sup>
Maximum $\theta_{jc} = 28^\circ\text{C/W}$ for cerdips per Mil-M-38510 .....	$< 28^\circ\text{C/W}$
Maximum $\theta_{jc} = 22^\circ\text{C/W}$ for flatpacks per Mil-M-38510 .....	$< 22^\circ\text{C/W}$
Maximum $\theta_{jc} = 20^\circ\text{C/W}$ for leadless chip carrier per Mil-M-38510 .....	$< 20^\circ\text{C/W}$

## Military Standard 20-Pin PAL Series

**PAL10H8, 12H6, 14H4, 16H2, 16C1, 10L8, 12L6, 14L4, 16L2**

Can be purchased to standard military drawings 81035, latest revision in effect.

## Military 20-Pin Half-Power PAL Series

**PAL10H8-2, 12H6-2, 14H4-2, 16H2-2, 16C1-2, 10L8-2, 12L6-2, 14L4-2, 16L2-2**

### Operating Conditions

SYMBOL	PARAMETER	MIN	MAX	UNIT
$V_{cc}$	Supply voltage	4.5	5.5	V
$T_A$	Operating free-air temperature	-55		°C
$T_c$	Operating case temperature		125	°C
$V_{IL}^*$	Low-level input voltage		≤0.8	V
$V_{IH}^*$	High-level input voltage	≥2.0		V

Note: Virgin array verify of unprogrammed PAL device is performed at 25°C only.

\* These are absolute voltages with respect to the ground pin on the device and include all overshoots due to system and/or tester noise.

### Electrical Characteristics Over Operating Conditions

SYMBOL	PARAMETER	TEST CONDITIONS		MIN	MAX	UNIT
$V_{ic}$	Input clamp voltage	$V_{cc} = \text{MIN}$	$I_i = -18 \text{ mA}$		-1.5	V
$I_{iL}$	Low-level input current	$V_{cc} = \text{MAX}$	$V_i = 0.4 \text{ V}$		-0.25	mA
$I_{iH}$	High-level input current	$V_{cc} = \text{MAX}$	$V_i = 2.4 \text{ V}$		25	μA
$I_i$	Maximum input current	$V_{cc} = \text{MAX}$	$V_i = 5.5 \text{ V}$		1	mA
$V_{oL}$	Low-level output voltage	$V_{cc} = \text{MIN}$	10H8, 12H6, 14H4, 16H2, 16C1, 10L8, 12L6, 14L4, 16L2		0.5	V
		$I_{oL} = 4 \text{ mA}$ $I_{oH} = -2 \text{ mA}$	10H8-2, 12H6-2, 14H4-2, 16H2-2, 16C1-2, 10L8-2, 12L6-2, 14L4-2, 16L2-2			
$V_{oH}$	High-level output voltage	$V_{cc} = \text{MIN}$	10H8, 12H6, 14H4, 16H2, 16C1, 10L8, 12L6, 14L4, 16L2	2.4		V
		$I_{oH} = -1 \text{ mA}$ $I_{oL} = -2 \text{ mA}$	10H8-2, 12H6-2, 14H4-2, 16H2-2, 16C1-2, 10L8-2, 12L6-2, 14L4-2, 16L2-2			
$I_{os}^*$	Output short-circuit current	$V_{cc} = 5 \text{ V}$	$V_o = 0.5 \text{ V}$	-30	-130	mA
$I_{cc}$	Supply current	$V_{cc} = \text{MAX}$	10H8, 12H6, 14H4, 16H2, 16C1, 10L8, 12L6, 14L4, 16L2		90	mA
			10H8-2, 12H6-2, 14H4-2, 16H2-2, 16C1-2, 10L8-2, 12L6-2, 14L4-2, 16L2-2		45	

\* Not more than one output should be shorted at a time and duration of the short circuit should not exceed one second.

**Military Standard 20-Pin PAL Series**

**PAL10H8, 12H6, 14H4, 16H2, 16C1, 10L8, 12L6, 14L4, 16L2**

**Military 20-Pin Half-Power PAL Series**

**PAL10H8-2, 12H6-2, 14H4-2, 16H2-2, 16C1-2, 10L8-2, 12L6-2, 14L4-2, 16L2-2**

**Switching Characteristics** Over Operating Conditions

SYMBOL	PARAMETER		TEST CONDITIONS	MIN	MAX	UNIT
$t_{PD}$	Input or feedback to output	10H8, 12H6, 14H4, 16H2, 16C1, 10L8, 12L6, 14L4, 16L2	$R_1 = 560 \Omega$ $R_2 = 1.1 K\Omega$		45	ns
		10H8-2, 12H6-2, 14H4-2, 16H2-2, 16C1-2, 10L8-2, 12L6-2, 14L4-2, 16L2-2	$R_1 = 1.12 K\Omega$ $R_2 = 2.2 K\Omega$		80	ns

Programmed devices conform to Mil-Std-883, Method 5005, Group A, Subgroups 1, 2, 3, 7, 8, 9, 10, and 11.

## Military Ultra High Speed 20-Pin PAL Series

### PAL16L8D, 16R8D, 16R6D, 16R4D

Can be purchased to standard military drawing 5962-85155, latest revision in effect.

## Military Very High Speed 20-Pin PAL Series

### PAL16L8B, 16R8B, 16R6B, 16R4B

Can be purchased to standard military drawing 5962-85155, latest revision in effect.

## Military High Speed 20-Pin PAL Series

### PAL16L8A, 16R8A, 16R6A, 16R4A

Can be purchased to standard military drawing 81036, latest revision in effect.

### Operating Conditions

SYMBOL	PARAMETER	20 D		20 B		20 A		UNIT
		MIN	MAX	MIN	MAX	MIN	MAX	
$V_{CC}$	Supply voltage	4.5	5.5	4.5	5.5	4.5	5.5	V
$T_A$	Operating free-air temperature	-55		-55		-55		°C
$T_c$	Operating case temperature		125		125		125	°C
$t_w^\dagger$	Width of clock (except 16L8)	Low	12	12		20		ns
		High	8	12		20		
$t_{su}^\dagger$	Set up time from input or feedback to clock (except 16L8)	15		20		30		ns
$t_h^\dagger$	Hold time	0		0		0		ns
$V_{IL}^*$	Low-level input voltage		≤0.8		≤0.8		≤0.8	V
$V_{IH}^*$	High-level input voltage	≥2.0		≥2.0		≥2.0		V

Note: Virgin array verify of unprogrammed PAL device is performed at 25°C only.

\*These are absolute voltages with respect to the ground pin on the device and include all overshoots due to system and/or tester noise.

†These are device set-up conditions, which are measured during initial qualification, and are not directly tested.

### Electrical Characteristics Over Operating Conditions

SYMBOL	PARAMETER	TEST CONDITIONS		MIN	MAX	UNIT
$V_{IC}$	Input clamp voltage	$V_{CC} = \text{MIN}$	$I_i = -18 \text{ mA}$		-1.5	V
$I_L^*$	Low-level input current	$V_{CC} = \text{MAX}$	$V_i = 0.4 \text{ V}$		-0.25	mA
$I_{IH}^*$	High-level input current	$V_{CC} = \text{MAX}$	$V_i = 2.4 \text{ V}$		25	μA
$I_i$	Maximum input current	$V_{CC} = \text{MAX}$	$V_i = 5.5 \text{ V}$		1	mA
$V_{OL}$	Low-level output voltage	$V_{CC} = \text{MIN}$	$I_{OL} = 12 \text{ mA}$		0.5	V
$V_{OH}$	High-level output voltage	$V_{CC} = \text{MIN}$	$I_{OH} = -2 \text{ mA}$	2.4		V
$I_{OZL}^*$	Off-state output current	$V_{CC} = \text{MAX}$	$V_o = 0.4 \text{ V}$		-100	μA
$I_{OZH}^*$			$V_o = 2.4 \text{ V}$		100	μA
$I_{OS}^{**}$	Output short-circuit current	$V_{CC} = 5 \text{ V}$	$V_o = 0.5 \text{ V}$	-30	-130	mA
$I_{CC}$	Supply current	$V_{CC} = \text{MAX}$			180	mA

\* I/O pin leakage is worst case of IIX or IOZX; i.e., IIL and IOZH.

\*\* Not more than one output should be shorted at a time and duration of the short circuit should not exceed one second.



## Military Ultra High Speed 20-Pin PAL Series

**PAL16L8D, 16R8D, 16R6D, 16R4D**

## Military Very High Speed 20-Pin PAL Series

**PAL16L8B, 16R8B, 16R6B, 16R4B**

## Military High Speed 20-Pin PAL Series

**PAL16L8A, 16R8A, 16R6A, 16R4A**

### Switching Characteristics Over Operating Conditions

SYMBOL	PARAMETER	TEST CONDITIONS	20 D		20 B		20 A		UNIT
			MIN	MAX	MIN	MAX	MIN	MAX	
$t_{PD}$	Input or feedback to output (except 16R8)	$R_1 = 390 \Omega$ $R_2 = 750 \Omega$		15		20		30	ns
$t_{CLK}$	Clock to output or feedback (except 16L8)			12		15		20	ns
$t_{PZX}$	Pin 11 to output enable (except 16L8)			12		20		25	ns
$t_{PXZ}$	Pin 11 to output disable (except 16L8)			10		20		25	ns
$t_{PZX}$	Input to output enable (except 16R8)			17		25		30	ns
$t_{PXZ}$	Input to output disable (except 16R8)			13		20		30	ns
$f_{MAX}^*$	State machine maximum operating frequency (except 16L8)			37		28.5		20	MHz
	Data path register maximum operating frequency (except 16L8)		50		41.6		25		

**5**

\* $f_{MAX}$  is calculated and measured on initial qualifications only.

$$f_{MAX} \text{ (state machine)} = 1/[t_{su} + t_{clk}]$$

$$f_{MAX} \text{ (data path register)} = 1/[t_{wh} + t_{wh}] \text{ or } 1/t_{su} + t_r, \text{ whichever is smaller.}$$

Programmed devices conform to Mil-Std-883, Method 5005, Group A, Subgroups 1,2,3,7,8,9,10 and 11.

## Military Half-Power 20B-Pin Series

### PAL16L8B-2, 16R8B-2, 16R6B-2, 16R4B-2

Can be purchased to standard military drawing 5962-85155, latest revision in effect.

## Military Half-Power 20A-Pin Series

### PAL16L8A-2, 16R8A-2, 16R6A-2, 16R4A-2

Can be purchased to standard military drawing 81036, latest revision in effect.

### Operating Conditions

SYMBOL	PARAMETER	20 B-2		20 A-2		UNIT
		MIN	MAX	MIN	MAX	
$V_{CC}$	Supply voltage	4.5	5.5	4.5	5.5	V
$T_A$	Operating free-air temperature	-55		-55	125	°C
$T_c$	Operating case temperature		125			°C
$t_w^\dagger$	Width of clock (except 16L8)	Low	20	25		ns
		High	20	25		
$t_{su}^\dagger$	Set up time from input or feedback to clock (except 16L8)	30		50		ns
$t_h^\dagger$	Hold time	0		0		ns
$V_L^*$	Low-level input voltage		≤0.8		≤0.8	V
$V_{IH}^*$	High-level input voltage	≥2.0		≥2.0		V

Note: Virgin array verify of unprogrammed PAL device is performed at 25°C only.

\* These are absolute voltages with respect to the ground pin on the device and include all overshoots due to system and/or tester noise.

† These are device set-up conditions, which are measured during initial qualification, and are not directly tested.

### Electrical Characteristics Over Operating Conditions

SYMBOL	PARAMETER	TEST CONDITIONS		MIN	MAX	UNIT
$V_{IC}$	Input clamp voltage	$V_{CC} = \text{MIN}$	$I_I = -18 \text{ mA}$		-1.5	V
$I_{IL}^*$	Low-level input current	$V_{CC} = \text{MAX}$	$V_I = 0.4 \text{ V}$		-0.25	mA
$I_{IH}^*$	High-level input current	$V_{CC} = \text{MAX}$	$V_I = 2.4 \text{ V}$		25	μA
$I_I$	Maximum input current	$V_{CC} = \text{MAX}$	$V_I = 5.5 \text{ V}$		1	mA
$V_{OL}$	Low-level output voltage	$V_{CC} = \text{MIN}$	$I_{OL} = 12 \text{ mA}$		0.5	V
$V_{OH}$	High-level output voltage	$V_{CC} = \text{MIN}$	$I_{OH} = -2 \text{ mA}$	2.4		V
$I_{OZL}^*$	Off-state output current	$V_{CC} = \text{MAX}$	$V_O = 0.4 \text{ V}$		-100	μA
$I_{OZH}^*$			$V_O = 2.4 \text{ V}$		100	
$I_{OS}^{**}$	Output short-circuit current	$V_{CC} = 5 \text{ V}$	16L8B-2, 16R8B-2, 16R6B-2, 16R4B-2		-250	mA
		$V_O = 0.5 \text{ V}$	16L8A-2, 16R8A-2, 16R6A-2, 16R4A-2	-30	-130	
$I_{CC}$	Supply current	$V_{CC} = \text{MAX}$			90	mA

\* I/O pin leakage is worst case of IIX or IOZX; i.e., IIL and IOZH.

\*\* Not more than one output should be shorted at a time and duration of the short circuit should not exceed one second.

## Military Half-Power 20B-Pin Series

### PAL16L8B-2, 16R8B-2, 16R6B-2, 16R4B-2

Can be purchased to standard military drawing 5962-85155, latest revision in effect.

## Military Half-Power 20A-Pin Series

### PAL16L8A-2, 16R8A-2, 16R6A-2, 16R4A-2

Can be purchased to standard military drawing 81036, latest revision in effect.

### Switching Characteristics Over Operating Conditions

SYMBOL	PARAMETER	TEST CONDITIONS	20 B-2		20 A-2		UNIT
			MIN	MAX	MIN	MAX	
$t_{PD}$	Input or feedback to output (except 16L8)	$R_1 = 390 \Omega$ $R_2 = 750 \Omega$		30		50	ns
$t_{CLK}$	Clock to output or feedback (except 16L8)			20		25	ns
$t_{PZX}$	Pin 11 to output enable (except 16L8)			25		25	ns
$t_{PXZ}$	Pin 11 to output disable (except 16L8)			25		25	ns
$t_{PZX}$	Input to output enable (except 16R8)			30		45	ns
$t_{PXZ}$	Input to output disable (except 16R8)			30		45	ns
$f_{MAX}^{**}$	State machine maximum operating frequency (except 16L8)		20		13.3	MHz	
	Data path register maximum operating frequency (except 16L8)		25		20		

\* $f_{MAX}$  is calculated and measured on initial qualifications only.

$$f_{MAX} \text{ (state machine)} = 1/[t_{su} + t_{CLK}]$$

$$f_{MAX} \text{ (data path register)} = 1/[t_{wk} + t_{wh}] \text{ or } 1/[t_{su} + t_h], \text{ whichever is smaller.}$$

Programmed devices conform to Mil-Std-883, Method 5005, Group A, Subgroups 1,2,3,7,8,9,10 and 11.

## Military 20-Pin PAL Devices

### Military Quarter-Power 20B-Pin Series

#### PAL16L8B-4, 16R8B-4, 16R6B-4, 16R4B-4

Can be purchased to standard military drawing 5962-88515 latest revision in effect.

### Military Quarter-Power 20A-Pin Series

#### PAL16L8A-4, 16R8A-4, 16R6A-4, 16R4A-4

Can be purchased to standard military drawing 85065 latest revision in effect.

#### Operating Conditions

SYMBOL	PARAMETER	20 B-4		20 A-4		UNIT
		MIN	MAX	MIN	MAX	
$V_{CC}$	Supply voltage	4.5	5.5	4.5	5.5	V
$T_A$	Operating free-air temperature	-55		-55	125	°C
$T_C$	Operating case temperature		125			°C
$t_w^\dagger$	Width of clock (except 16L8)	Low	25	40		ns
		High	25	40		
$t_{su}$	Set up time from input or feedback to clock (except 16L8)	50		90		ns
$t_h^\dagger$	Hold time	0		0		ns
$V_{IL}^*$	Low-level input voltage		≤0.8		≤0.8	V
$V_{IH}^*$	High-level input voltage	≥2.0		≥2.0		V

Note: Virgin array verify of unprogrammed PAL device is performed at 25°C only.

\* These are absolute voltages with respect to the ground pin on the device and include all overshoots due to system and/or tester noise.

† These are device set-up conditions, which are measured during initial qualification, and are not directly tested.

#### Electrical Characteristics Over Operating Conditions

SYMBOL	PARAMETER	TEST CONDITIONS		MIN	MAX	UNIT
$V_{IC}$	Input clamp voltage	$V_{CC} = \text{MIN}$	$I_i = -18 \text{ mA}$		-1.5	V
$I_{IL}^*$	Low-level input current	$V_{CC} = \text{MAX}$	$V_i = 0.4 \text{ V}$		-0.25	mA
$I_{IH}^*$	High-level input current	$V_{CC} = \text{MAX}$	$V_i = 2.4 \text{ V}$		25	μA
$I_i$	Maximum input current	$V_{CC} = \text{MAX}$	$V_i = 5.5 \text{ V}$		1	mA
$V_{OL}$	Low-level output voltage	$V_{CC} = \text{MIN}$	$I_{OL} = 4 \text{ mA}$		0.5	V
$V_{OH}$	High-level output voltage	$V_{CC} = \text{MIN}$	$I_{OH} = -1 \text{ mA}$	2.4		V
$I_{OZL}^*$	Off-state output current	$V_{CC} = \text{MAX}$	$V_o = 0.4 \text{ V}$		-100	μA
$I_{OZH}^*$			$V_o = 2.4 \text{ V}$		100	
$I_{OS}^{**}$	Output short-circuit current	$V_{CC} = 5 \text{ V}$	16L8B-4, 16R8B-4, 16R6 B-4, 16R4B-4		-250	mA
		$V_o = 0.5 \text{ V}$	16L8A-4, 16R8A-4, 16R6A-4, 16R4A-4	-30	-130	
$I_{CC}$	Supply current	$V_{CC} = \text{MAX}$	16L8A-4, 16R8A-4, 16R6A-4, 16R4A-4		50	mA
			16L8B-4, 16R8B-4, 16R6B-4, 16R4B-4		55	

\* I/O pin leakage is worst case of IIX or IOZX; i.e., IIL and IOZH.

\*\* Not more than one output should be shorted at a time and duration of the short circuit should not exceed one second.

## Military Quarter-Power 20B-Pin Series

PAL16L8B-4, 16R8B-4, 16R6B-4, 16R4B-4

## Military Quarter-Power 20A-Pin Series

PAL16L8A-4, 16R8A-4, 16R6A-4, 16R4A-4

### Switching Characteristics Over Operating Conditions

SYMBOL	PARAMETER	TEST CONDITIONS	20 B-4		20 A-4		UNIT
			MIN	MAX	MIN	MAX	
$t_{PD}$	Input or feedback to output (except 16R8)	$R_1 = 800 \Omega$ $R_2 = 1.56 K\Omega$		50	75	ns	
$t_{CLK}$	Clock to output or feedback (except 16L8)			25	45	ns	
$t_{PXZ}$	Pin 11 to output enable (except 16L8)			25	40	ns	
$t_{PXZ}$	Pin 11 to output disable (except 16L8)			25	40	ns	
$t_{PZX}$	Input to output enable (except 16R8)			45	65	ns	
$t_{PZX}$	Input to output disable (except 16R8)			45	65	ns	
$f_{MAX}^*$	State machine maximum operating frequency (except 16L8)			13.3	7.4	MHz	
	Data path register maximum operating frequency (except 16L8)		20	12.5			

\* $f_{MAX}$  is calculated and measured on initial qualifications only.

$$f_{MAX} \text{ (state machine)} = 1 / (t_{su} + t_{clk})$$

$$f_{MAX} \text{ (data path register)} = 1 / (t_{wl} + t_{wh}) \text{ or } 1 / (t_{su} + t_h), \text{ whichever is smaller.}$$

Programmed devices conform to Mil-Std-883, Method 5005, Group A, Subgroups 1,2,3,7,8,9,10 and 11.

# Military Arithmetic 20-Pin PAL Series

## PAL16X4

### Operating Conditions

SYMBOL	PARAMETER	MIN	MAX	UNIT
$V_{CC}$	Supply voltage	4.5	5.5	V
$T_A$	Operating free-air temperature	-55		°C
$T_C$	Operating case temperature		125	°C
$t_w^\dagger$	Width of clock	Low	25	ns
		High	25	
$t_{su}^\dagger$	Set up time from input or feedback to clock	55		ns
$t_h^\dagger$	Hold time	0		ns
$V_{IL}^*$	Low-level input voltage		≤0.8	V
$V_{IH}^*$	High-level input voltage	≥2.0		V

Note: Virgin array verify of unprogrammed PAL device is performed at 25°C only.

\* These are absolute voltages with respect to the ground pin on the device and include all overshoots due to system and/or tester noise.

† These are device set-up conditions, which are measured during initial qualification, and are not directly tested.

### Electrical Characteristics Over Operating Conditions

SYMBOL	PARAMETER	TEST CONDITIONS		MIN	MAX	UNIT
$V_{IC}$	Input clamp voltage	$V_{CC} = \text{MIN}$	$I_I = -18 \text{ mA}$		-1.5	V
$I_{IL}^*$	Low-level input current	$V_{CC} = \text{MAX}$	$V_I = 0.4 \text{ V}$		-0.25	mA
$I_{IH}^*$	High-level input current	$V_{CC} = \text{MAX}$	$V_I = 2.4 \text{ V}$		25	μA
$I_I$	Maximum input current	$V_{CC} = \text{MAX}$	$V_I = 5.5 \text{ V}$		1	mA
$V_{OL}$	Low-level output voltage	$V_{CC} = \text{MIN}$	$I_{OL} = 12 \text{ mA}$		0.5	V
$V_{OH}$	High-level output voltage	$V_{CC} = \text{MIN}$	$I_{OH} = -2 \text{ mA}$	2.4		V
$I_{OZL}^*$	Off-state output current	$V_{CC} = \text{MAX}$	$V_O = 0.4 \text{ V}$		-100	μA
$I_{OZH}^*$			$V_O = 2.4 \text{ V}$		100	μA
$I_{OS}^{**}$	Output short-circuit current	$V_{CC} = 5 \text{ V}$	$V_O = 0.5 \text{ V}$	-30	-130	mA
$I_{CC}$	Supply current	$V_{CC} = \text{MAX}$	16X 4		225	mA

\* I/O pin leakage is worst case of IIX or IOZX; i.e., IIL and IOZH.

\*\* Not more than one output should be shorted at a time and duration of the short circuit should not exceed one second.

# Military Arithmetic 20-Pin PAL Devices

## PAL16X4

### Switching Characteristics Over Operating Conditions

SYMBOL	PARAMETER	TEST CONDITIONS	MIN	MAX	UNIT
$t_{PD}$	Input or feedback to output	$R_1 = 200 \Omega$ $R_2 = 390 \Omega$		45	ns
$t_{CLK}$	Clock to output or feedback			25	ns
$t_{PZX}$	Pin 11 to output enable			25	ns
$t_{PXZ}$	Pin 11 to output disable			25	ns
$t_{PZX}$	Input to output enable			45	ns
$t_{PXZ}$	Input to output disable			45	ns
$f_{MAX}$	Maximum frequency			12.5	

Programmed devices conform to Mil-Std-883, Method 5005, Group A, Subgroups 1,2,3,7,8,9,10 and 11.

# Military 20-Pin PAL Devices

## Switching Waveforms

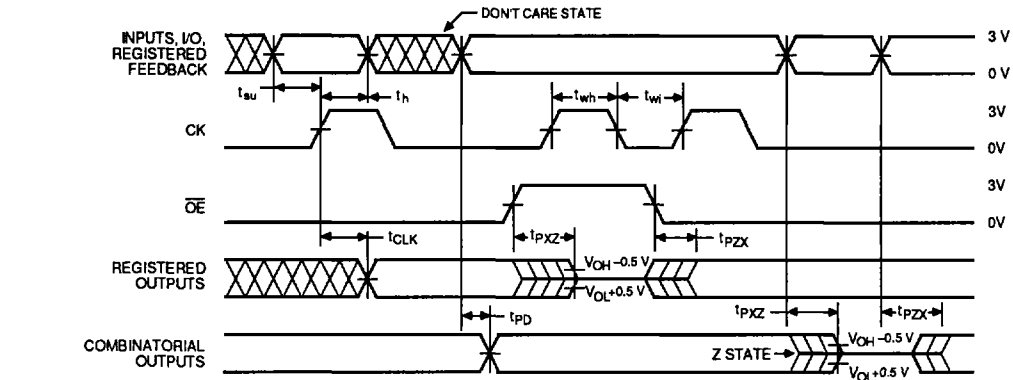

503 133

- Notes:
1.  $t_{pD}$  is tested with switch  $S_1$  closed.  $C_L = 50$  pF and measured at 1.5 V output level.
  2.  $t_{pZX}$  is measured at the 1.5 V level with  $C_L = 50$  pF.  $S_1$  is open for high impedance to "1" test, and closed for high impedance to "0" test.
  3.  $t_{pZX}$  is tested with  $C_L = 5$  pF.  $S_1$  is open for "1" to high impedance test, measured  $V_{OH} - 0.5 V$  output level.  $S_1$  is closed for "0" to high impedance test measured to  $V_{OL} + 0.5 V$  output level.
  4. Equivalent test loads may be used on automatic test equipment.

## Test Load

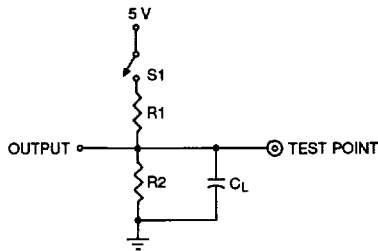

503 194



# Military 20-Pin PAL Devices

## Life Test/Burn-In Circuits

Complies with Mil-Std-883, Method 1005/1015, Condition D.

## Circuit Configurations

### Waveforms

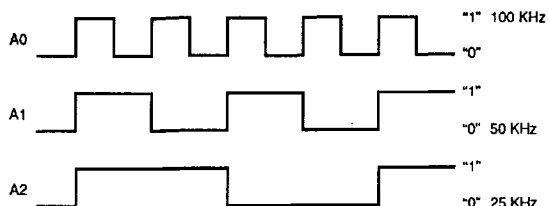

A3 to Ax Follow in order

503 134

1. All Burn-In will be accomplished at 125° C +5/-0°C
2.  $V_{cc} = 5.25 \text{ Volts} \pm 0.25 \text{ V}$
3. All clocks (A0 to Ax) are square wave signals, 50±15% Duty Cycle, with:
  - a. "0" = -0.5 V to +0.7 V
  - b. "1" = +2.4 V to  $V_{cc}$
  - c. Rise Time (+0.7 V to +2.4 V) < 1 μsec
  - d. Fall Time (+2.4 V to +0.7 V) < 1 μsec
4. Resistor Value  
330 Ω or 470 Ω ±5%
5. All Board Components to be compatible with 150°C Ambient (Min).

**PAL10H8/H8-2**  
**PAL10L8/L8-2**

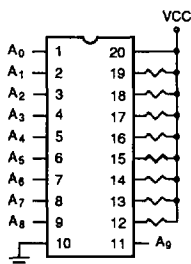

**PAL12H6/H6-2**  
**PAL12L6/L6-2**

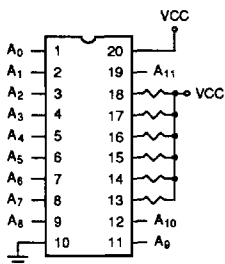

**PAL14H4/H4-2**  
**PAL14L4/L4-2**

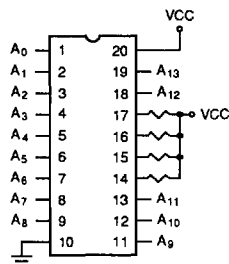

503 135

5

# Military 20-Pin PAL Devices

## Life Test/Burn-In Circuits

Complies with Mil-Std-883, Method 1005/1015, Condition D.

## Circuit Configurations

**PAL16H2/H2-2**  
**PAL16L2/L2-2**  
**PAL16C1/C1-2**

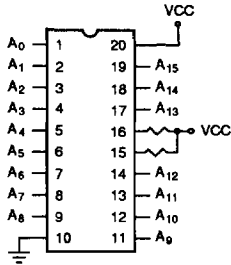

**PAL16L8A/B/D**  
**PAL16L8A-2/B-2**  
**PAL16L8A-4/B-4**

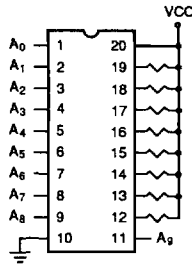

**PAL16R8A/B/D**  
**PAL16R8A-2/B-2**  
**PAL16R8A-4/B-4**

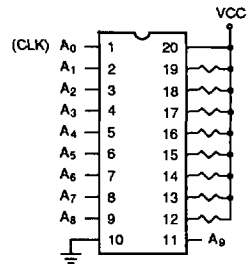

**PAL16R6A/B/D**  
**PAL16R6A-2/B-2**  
**PAL16R6A-4/B-4**

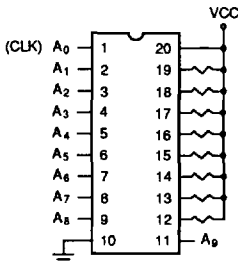

**PAL16R4A/B/D**  
**PAL16R4A-2/B-2**  
**PAL16R4A-4/B-4**

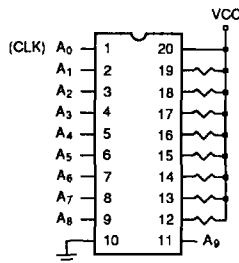

**PAL16A4**  
**PAL16X4**

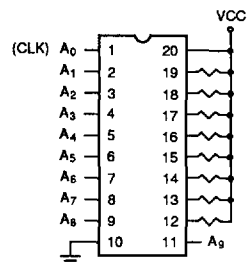

503 138