

# PRODUCT SPECIFICATION

*Part Number*  
**PLBT3838D-WCIR94**

## Details

- 3838 Infrared Emitter
- 3.85mm x 3.85mm x 2.21mm
- 940nm - 90° v/a
- Package: Clear Silicone

## Features

- Corrosion robustness class: 3B
- ESD: 2KV (HBM: MIL-STD-883 Class 2)
- Dual junction emitter
- RoHS & REACH Compliant

## Mechanical Dimensions

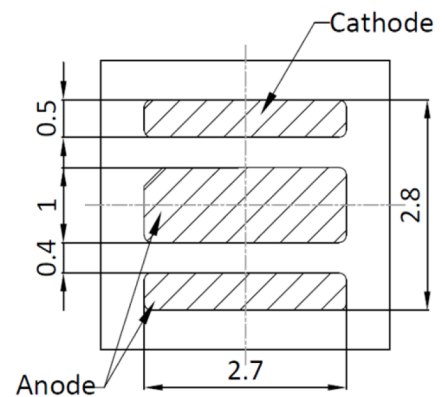
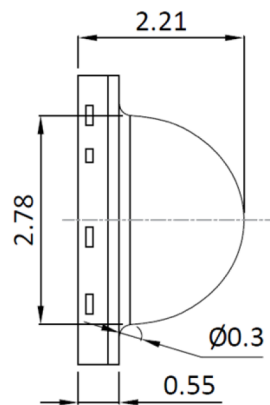
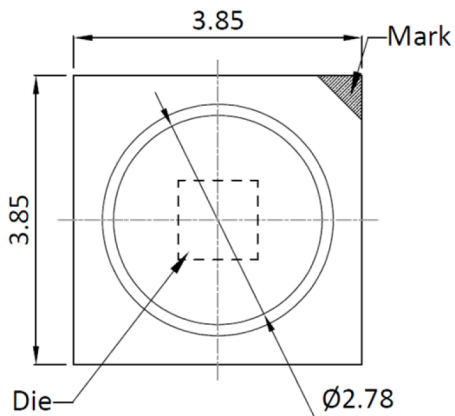

### Notes:

1. Specifications subject to change without notice
2. All dimensions are in millimeters unless otherwise noted
3. Tolerance is  $\pm 0.1$  mm unless otherwise noted





### Device Selection Guide

Model Number	Emitting Color	Lens Color	Viewing Angle
PLBT3838D-WCIR94	Infrared (IR)	Clear	90°

Notes:

1. Forward voltage (VF)  $\pm 0.05V$  ; Luminous flux ( $\Phi V$ )  $\pm 7\%$  ; CRI  $\pm 2$  ; Viewing angle( $2\theta_{1/2}$ )  $\pm 10^\circ$
2. IS standard testing.

### Absolute Maximum Ratings at $T_a=25^\circ C$

Parameter	Symbol	Rating			Unit
		Min.	Typ.	Max	
Forward Current	IF	--	--	1	A
Power Consumption	Ptot	--	--	3.4	W
Reverse Voltage	Vr	--	--	5	V
Junction Temperature	TJ	--	--	145	°C
Operating Temperature Range	Topr	-40	--	100	°C
Storage Temperature Range	Tstg	-40	--	100	°C
Thermal Resistance Junction / Solder Point	RTH	--	--	12	K/W
ESD (withstand voltage (HBM : MIL-STD-883 Class 2)	VESD	--	--	2	kV

Notes:

1. For other ambient, limited setting of current will depend on de-rating curves.
2. When drive on maximum current, Junction temperature must be kept below 145oC

### Electrical Characteristics at $T_a=25^\circ C$ , IF: 1A, TP: 10ms

Parameter	Symbol	Rating			Unit
		Min.	Typ.	Max	
Peak Wavelength	$\lambda_p$	--	940	--	nm
Spectral Bandwidth	$\Delta\lambda$	--	25	--	nm
Viewing Angle	$2\theta_{1/2}$	--	--	90°	deg
Total Radiated Power	$\Phi_e$	--	1300	1500	mW
Radiant Intensity	IE	--	760	--	mW/sr
Forward Voltage	VF	--	3.1	3.4	V
Reverse current (VR=5V)	IR	--	--	10	$\mu A$

### Typical Electrical Optical Characteristic Curves

Radiation Characteristics

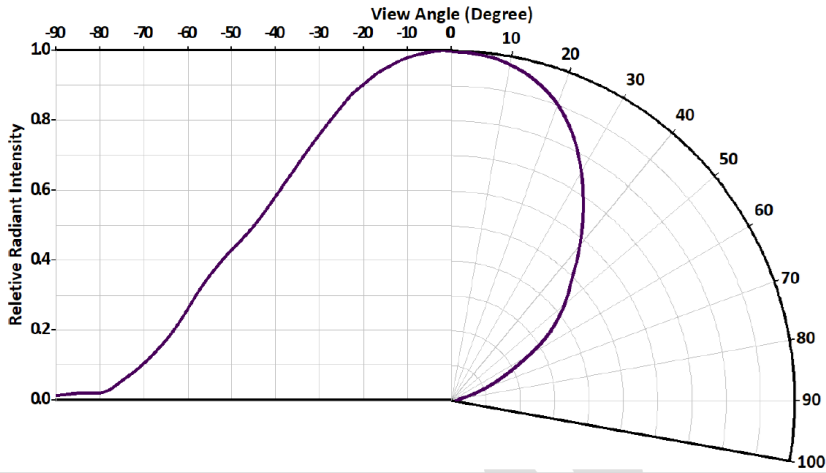

Relative Radiant Intensity

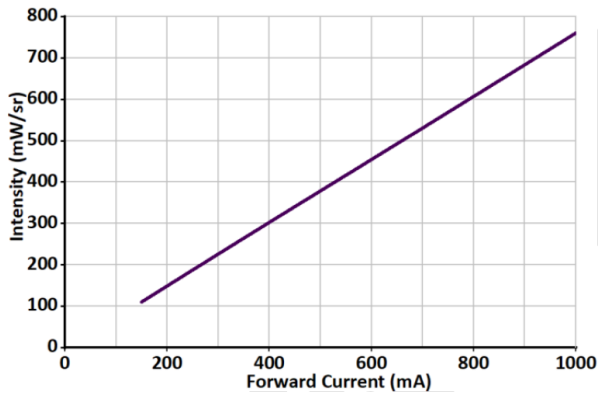

Relative Total Radiant Power

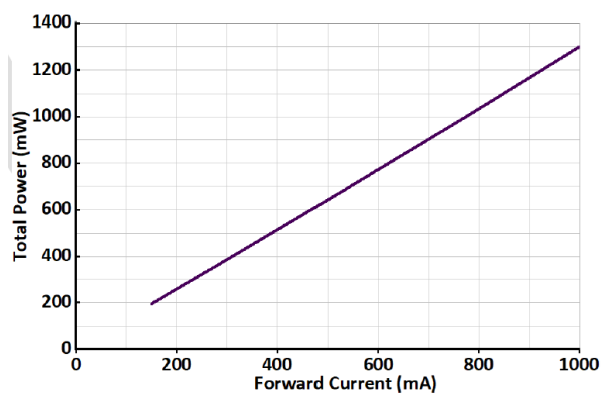

Forward Current

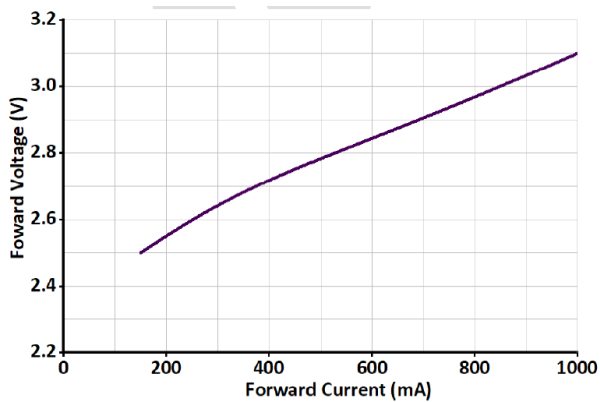

Relative Spectral Emission

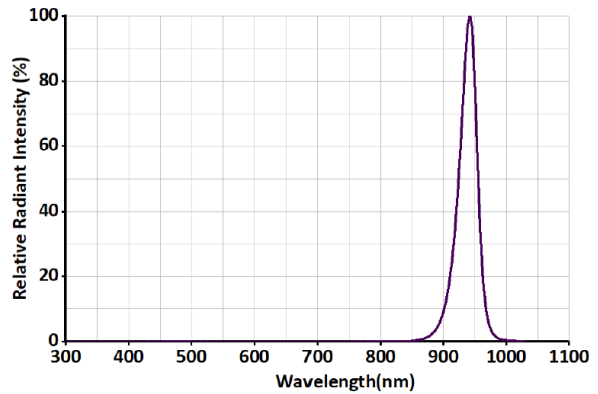

### Reflow Soldering Profile

Product complies to MSL Level 2 according to JEDEC J-STD-020E

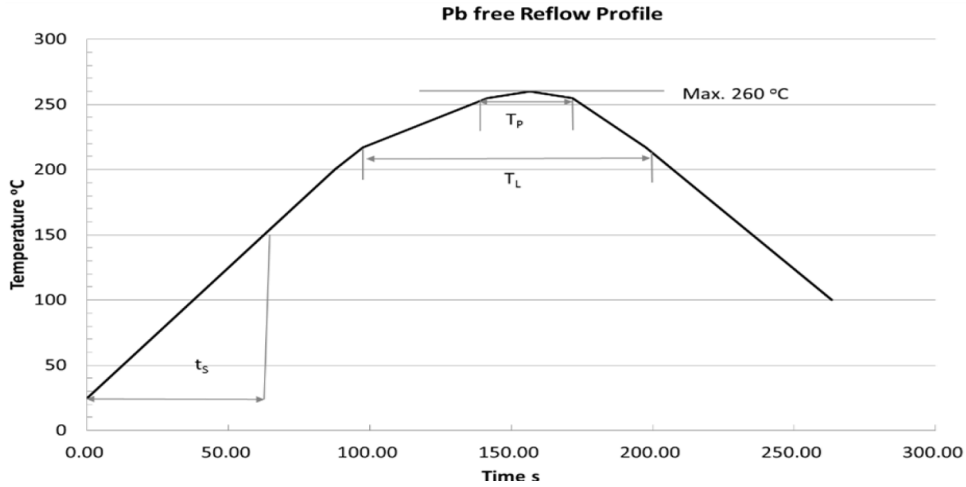

Profile Feature	Symbol	Pb-Free (SnAgCu) Assembly			Unit
		Minimum	Recommendation	Maximum	
Ramp-up rate to preheat 25 °C to 150 °C			2	3	K/s
Time $t_s$ $T_{Smin}$ to $T_{Smax}$	$t_s$	60	100	120	s
Ramp-up rate to peak $T_{Smax}$ to $T_P$			2	3	K/s
Liquidus temperature	$T_L$		217		°C
Time above liquidus temperature	$t_L$		80	100	s
Peak temperature	$T_P$		245	260	°C
Time within 5 °C of the specified peak temperature $T_P - 5$ K	$T_P$	10	20	30	s
Ramp-down Rate $T_P$ to 100 °C			3	4	K/s
Time 25 °C to $T_P$				480	s

1. Do not stress the silicone resin while it is exposed to high temperature.
2. The reflow process should not exceed 2 times.



<b>PLBT3838D-WCIR94 Customer Approval Signatures</b>	<b>Approved By</b>

<b>Record of Revisions</b>			
<b>Rev.</b>	<b>Comments</b>	<b>Page</b>	<b>Date</b>
0	Released Spec	--	6/23/22