

QuPanel LTE MIMO 4x4

Directional High Power multiband LTE MIMO 4x4 antenna

QuPanel LTE directional MIMO 4x4 high gain antenna is predicted for 4G LTE high categories from cat 5 up to cat 19. The antenna improves the signal in rural/suburban and locations where the mobile signal is weak. That antenna is predicted to be installed on the buildings (on the pole or on the wall). Due to very wide working frequency range, the antenna is universal client for LTE bands like LTE700/800/1800/1900/2100/2300/2600. It's compatible with all MIMO 4x4 LTE modems and routers working in categories: cat 5, cat 6, cat 7, cat 9, cat 10, cat 11, cat 12, cat 13, cat 15, cat 16, cat 18, cat 19.



OUTDOOR

Use LTE router wherever you want

ANTENNA

Maximize your signal with QuWireless antennas

SOLUTION

Plug LTE router and you are good to go

LTE SPECIFICATION

FREQUENCY	0.694-0.96 GHz 1.7 - 2.2 GHz 2.2 - 2.7 GHz
Supported LTE bands	1, 2, 3, 4, 5, 6, 7, 8, 9, 10, 12, 13, 14, 15, 16, 17, 18, 19, 20, 23, 25, 26, 27, 28, 29, 30, 33, 34, 35, 36, 37, 38, 39, 40, 41, 44, 53, 65, 66, 67, 68, 69, 70, 85
GAIN	0.694 - 0.96 GHz : 4 dBi 1.7 - 2.2 GHz : 5 dBi 2.2 - 2.7 GHz : 6 dBi
VSWR	<1.30, max <1.80
BEAMWIDTH	90°/90° ±30°
POLARIZATION	4x Vertical
IMPEDANCE	50 Ω

MECHANICAL SPECIFICATION

MATERIALS	ABS, aluminum, Fiberglass, galvanized steel
INGRESS PROTECTION	IP67
DIMENSIONS	272 x 276 x 96 mm 10.71 x 10.87 x 3.78 inch
WEIGHT	1.88 kg 4.15 lbs
OPERATING TEMPERATURE	From -40°C to 75°C From -40°F to 167°F

VSWR

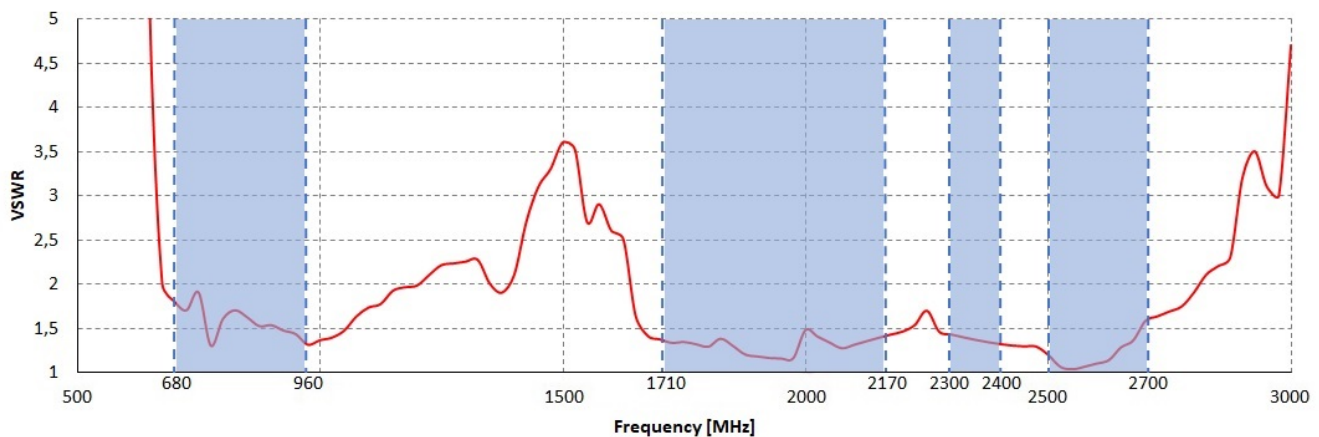

PLOTS

700-900 MHz Azimuth

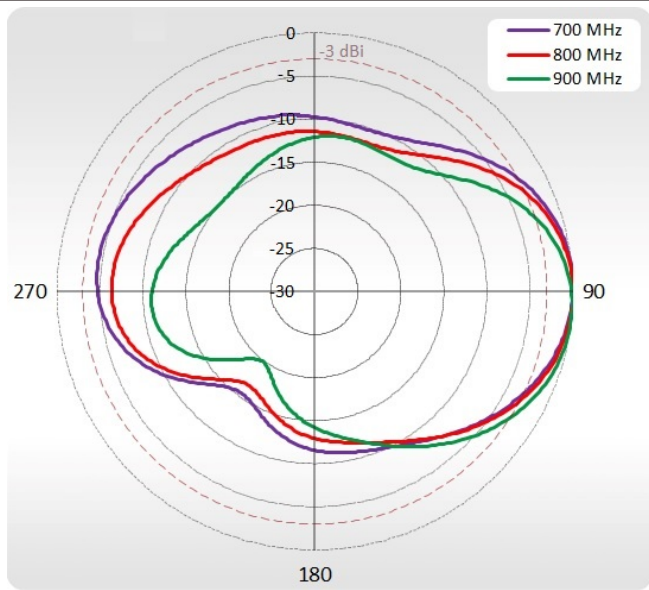

700-900 MHz Elevation

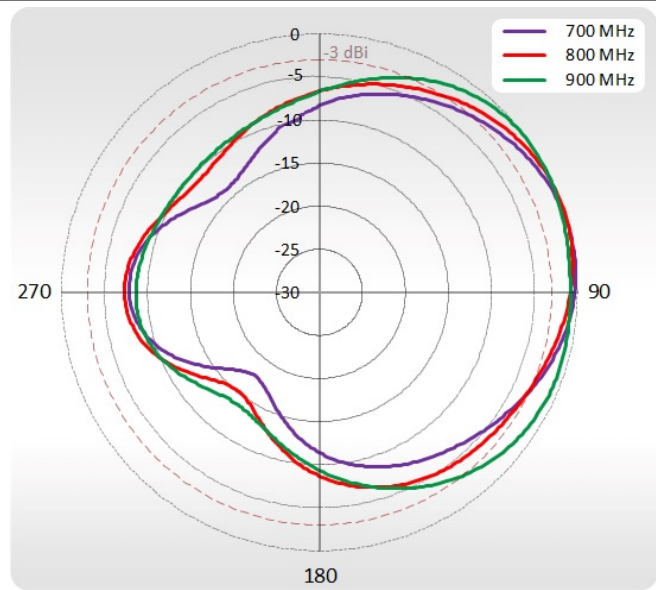

1710-2170 MHz Azimuth

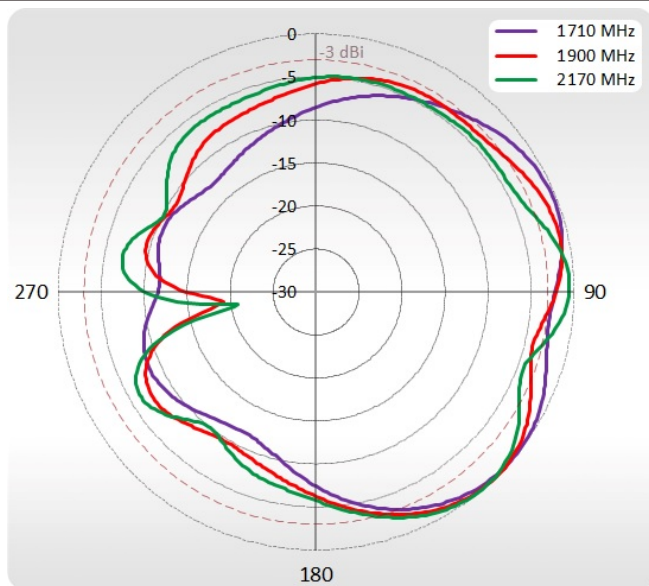

1710-2170 MHz Elevation

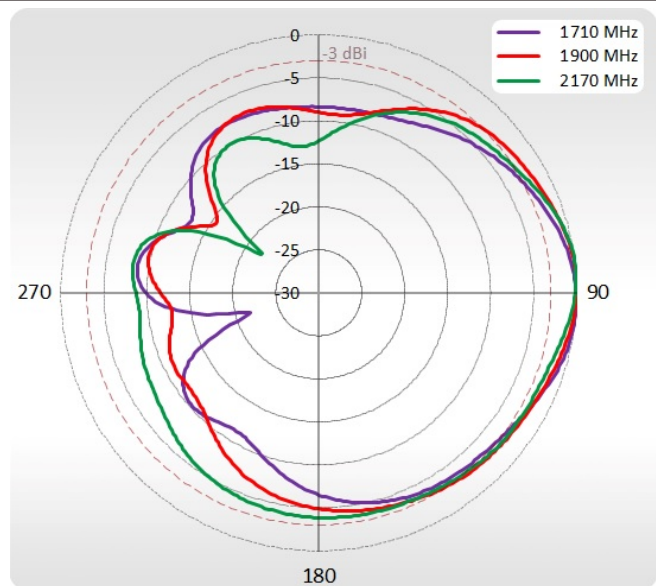

2300-2700 MHz Azimuth

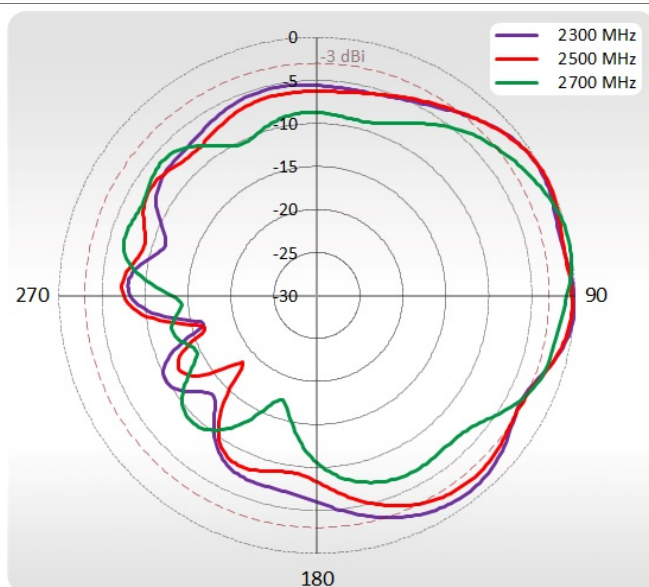

2300-2700 MHz Elevation

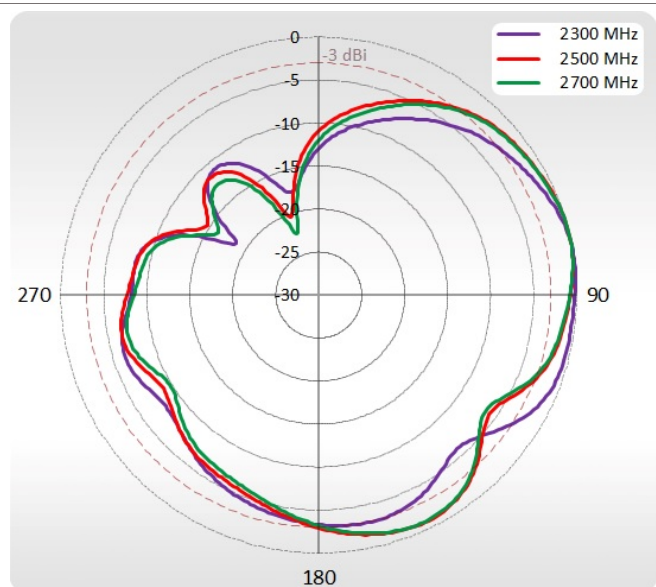

PHOTOS



DIMENSIONS

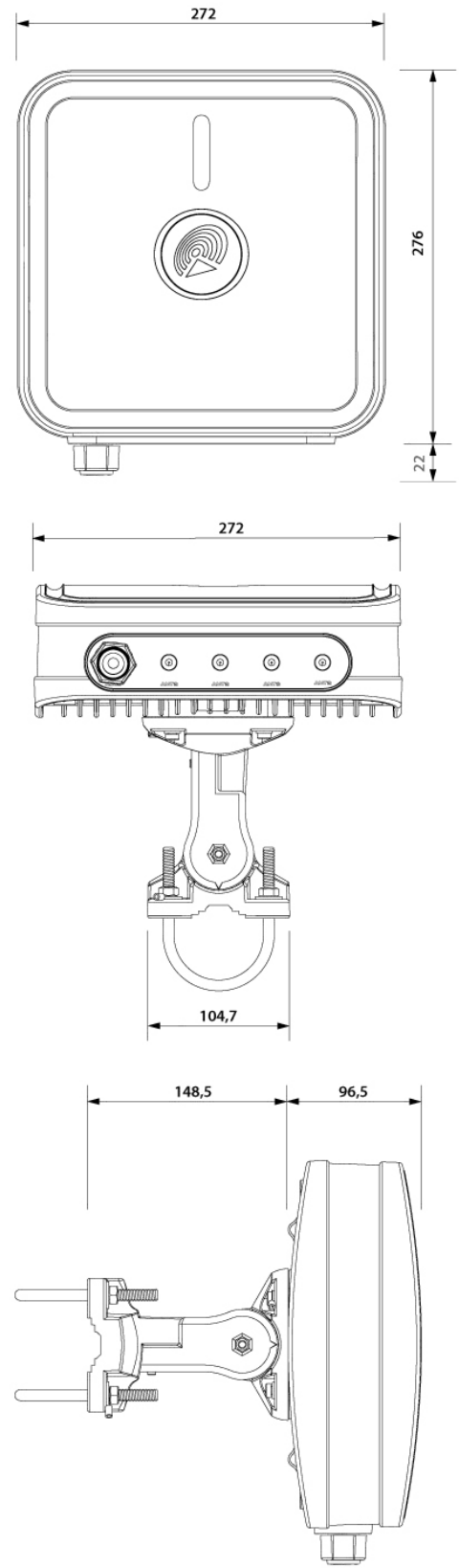

HEADQUARTER:

Wireless Instruments sp. z o.o.

ul. Kościuszki 27

52-116 Iwiny

POLAND

sales@quwireless.com

tel 1. +48 601 366 369

tel 2. +48 577 667 761

www.quwireless.com