



24V/50mA General-Purpose Output-Driver

General Description

The epc70x family is a general purpose high-side power switch for 24V interfaces. A low-side switch is also available, please refer to the separate data sheet of epc700/702. The device is capable to drive a load of 50mA at 30VDC. If a higher driving current is necessary or if the output voltage shall be higher than 30VDC, these chips can be used to drive an external power transistor. In this mode of operation, the external transistor is fully protected against over-current by the epc chip.

If the current through the external load exceeds a specified threshold during a longer time period than a predefined time, the output is turned off to protect the output switch. The switch is turned on again after a predefined off-time, thus enabling the load again in a self-healing mechanism. The over-current information is indicated on the STATUS pin.

epc701 and epc703 are easy to use and reduce the need of external components to the minimum, thus saving pcb space and money.

Features

- High-side power switch
- Driving capability without external transistor 50 mA/30VDC
- Programmable short-circuit detection delay-time and recovery time
- Static (epc701) or flashing (epc703) indication of the over-current status
- Self-healing output mode
- Available in CSP6 package with very small footprint.

Applications

- PLC
- Sensors
- Controllers

Functional Block Diagram

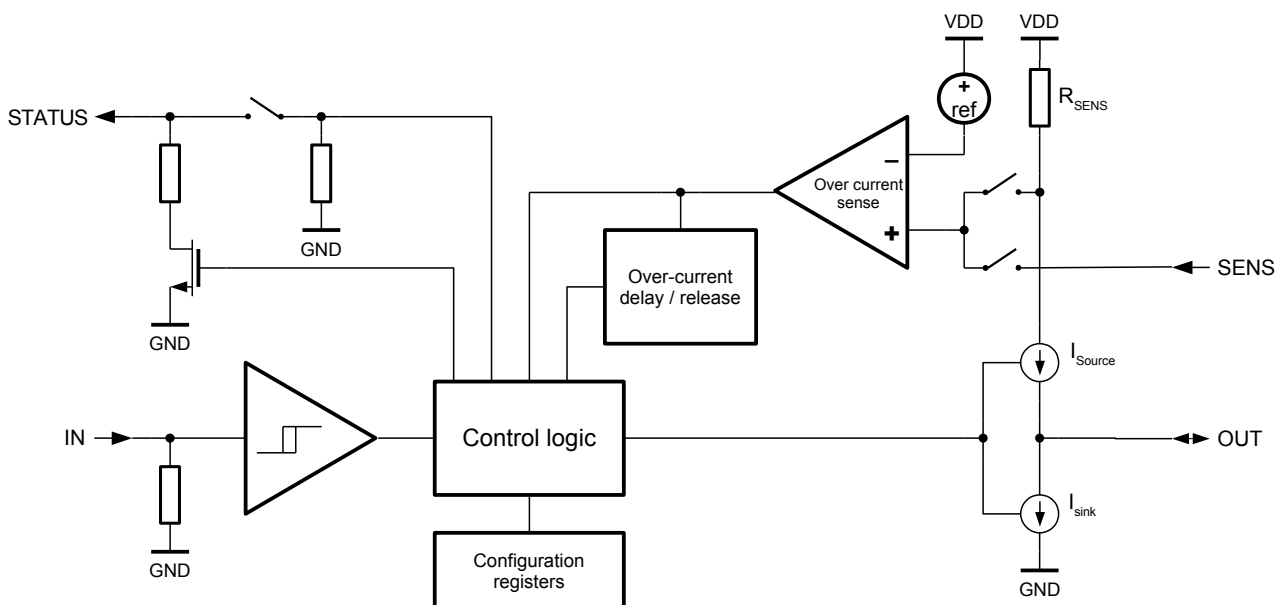

| Absolute Maximum Ratings (Note 1) | | Recommended Operating Conditions | | |
|---|--------------------------|----------------------------------|------|---------------------------|
| Power Supply Voltage V_{DD} | -0.3 to +36.0 V (Note 2) | Min. | Max. | Units |
| maximum Power Dissipation | 100mW | 9.6 | 30 | V |
| Storage Temperature Range (T_S) | -40°C to +85°C | -40° | +85° | C |
| Lead Temperature solder, 4 sec. (T_L) | +260°C | +5 | +95 | % |
| | | | | Humidity (non-condensing) |

Note 1: Absolute Maximum Ratings indicate limits beyond which damage to the device may occur. Recommended operating conditions indicate conditions for which the device is intended to be functional, but do not guarantee specific performance limits. For guaranteed specifications and test conditions, see Electrical Characteristics.

Note 2: Supply voltages up to 36 Volts may be present for 10 seconds only.

Note 3: This device is a highly sensitive CMOS amplifier with an ESD rating of JEDEC HBM class 1C (>1kV). Handling and assembly of this device should only be done at ESD protected workstations.

Electrical Characteristics

$V_{DD} = 9.6V < V_{DD} < 30V, -40^\circ C < T_A < +85^\circ C$

| Symbol | Parameter | Conditions/Comments | Values | | | Units | |
|-----------------|-----------------------------------|---|---|------|-------|------------|---------|
| | | | Min. | Typ. | Max. | | |
| V_{DD} | Supply Voltage | | 9.6 | | 30 | V | |
| ΔV_{DD} | Ripple on Supply Voltage | Peak-Peak | | | 10 | % V_{DD} | |
| I_{DD} | Supply Current | no load | | 300 | 400 | μA | |
| V_{OUT} | Output Voltage | | 0 | | 30 | V | |
| V_{Sat} | Output Saturation Voltage | @50mA output current referenced to V_{DD} | | -1 | -2 | V | |
| I_{SENS} | Sens Current | Current trigger threshold | 40 | 60 | 70 | mA | |
| V_{SENS} | Current Sens Voltage | Over-current trigger threshold voltage (by using an external power switch), referenced to V_{DD} | -0.14 | -0.2 | -0.25 | V | |
| I_{Peak} | Short Circuit Peak Current | Initial current during a short circuit (<1ms, 50 Ω series resistor) | | | -0.6 | A | |
| V_{Status} | Status Output (referenced to GND) | Logical high | 2 | | 5.5 | V | |
| | | Logical low | -0.3 | | 0.8 | | |
| | | Sink driving capability | -8 | -10 | -12 | mA | |
| f_{Status} | Status Output Frequency | epc703 only, duty cycle 50% | 1.5 | 1.7 | 1.9 | Hz | |
| V_{IN} | Input (referenced to GND) | Logical high | 2.0 | | 5.5 | V | |
| | | Logical low | -0.3 | | 0.8 | | |
| | | Hysteresis | 0.25 | | | | |
| | | Pull-down resistance | 100 | 150 | 200 | k Ω | |
| P_{DIS} | Power Dissipation | On-chip power dissipation | | | 100 | mW | |
| t_{ON} | Response Time | On | | 1.0 | 1.2 | μs | |
| t_{OFF} | Response Time | Off | | 0.7 | 1.0 | μs | |
| t_{del} | Off-delay Time | Time between over-current detection and STATUS/OUT change (default value), refer to section Programming | epc701-CSP6-A | 40 | 50 | 60 | μs |
| | | | epc703-CSP6 epc701-QFN16 epc703-QFN16 | 80 | 100 | 120 | |
| | | Programmable off-delay values | 5/10/20/50/100/200/500/1,000 | | | | |

| | | | | | | | |
|---------------|--|--|---|-----|-----|-----|---------|
| t_{minOFF} | Recovery Time | Minimum down time of the OUT pin to protect the external transistor (default value), refer to section Programming | epc701-CSP6-A | 400 | 500 | 600 | ms |
| | | | epc703-CSP6 epc701-QFN16 epc703-QFN16 | 18 | 20 | 22 | |
| | | Programmable values | 10/20/50/100/200/500/1,000/1,500 | | | | |
| f_{rt} | Short circuit recovery delay time factor | $t_{minoff}/t_{delay} = f_{rt}$ (when used without external driver transistor, refer to section "Over-current Reset Sequence") | 1,000 | | | | |
| $t_{STARTUP}$ | Start-up time | VDD ramp > 100 V/ms | | | 200 | | μ s |
| C_{L_max} | External Load Capacitance | Load capacitance that can be driven through OUT without triggering over-current @2kOhm load and 5 μ s delay time | | 30 | | | nF |

Connection Diagrams

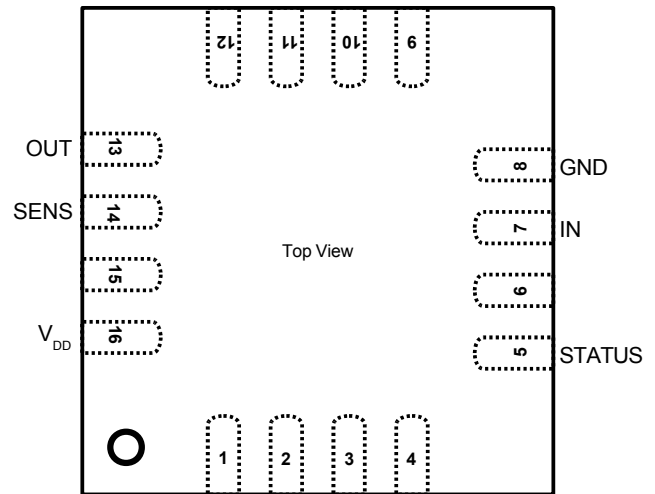
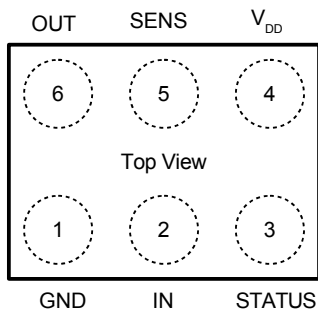

6-Pin Chip Scale Package (CSP)

16-Pin QFN Package

Note: For sampling only. Limited quantities. Please inquire.

| 6-Pin CSP | 16-Pin QFN | Pin Name | Description |
|-----------|------------------|-----------------|---|
| 1 | 8 | GND | Negative power supply pin |
| 2 | 7 | IN | Input from the controller |
| 3 | 5 | STATUS | Output status signal to the controller |
| 4 | 16 | V _{DD} | Positive power supply pin |
| 5 | 14 | SENS | Input either to switch internal/external mode or to measure the voltage drop on an external shunt resistor to detect over-current |
| 6 | 13 | OUT | Output |
| n/a | 1-4, 6, 9-12, 15 | NC | Not connected. Connect these pins to GND. |

Functional Description

Normal Operation

During typical operation the OUT follows the IN as shown in Figure 1. In the other state (when IN is set to high level), the internal switch is closed pulling the OUT pin to V_{DD} . As long as the output current does not exceed the current threshold, OUT is stable ON and STATUS is stable HIGH-Z. The delay from IN to OUT is defined as t_{ON} and t_{OFF} for the rising and the falling edge respectively.

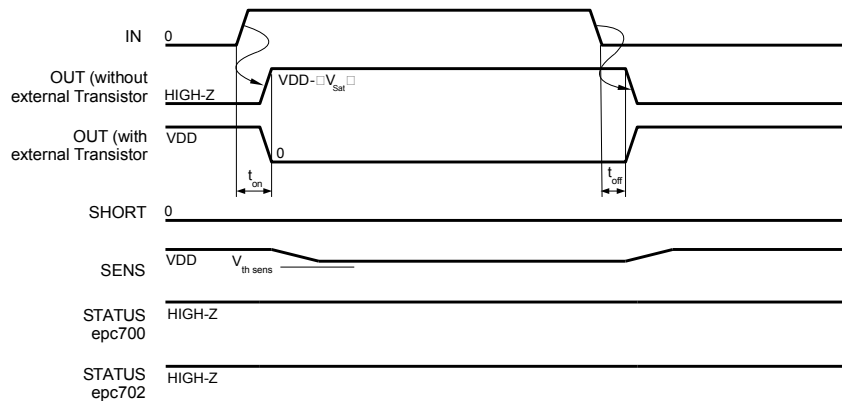

Figure 1: Normal operation

Please note that the status of the pin OUT is dependent whether the chip is operated with or without external driver transistor. In the subsequent diagrams, the version without external driver transistor is shown only.

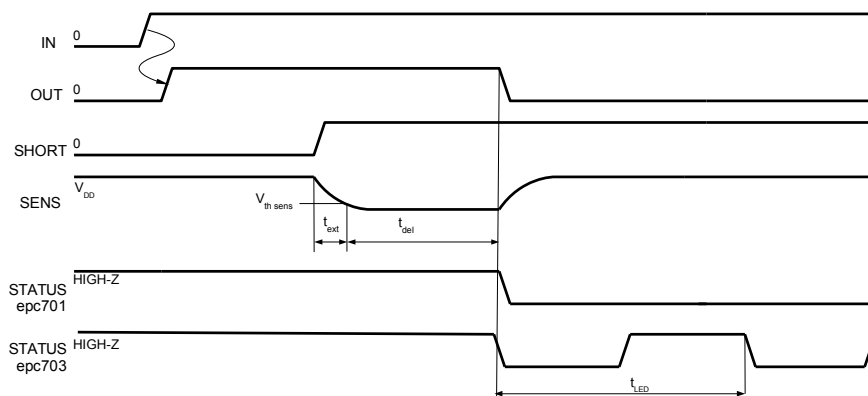

Figure 2: Short circuit detection

Note: The parameter t_{ext} used in this paper is described in Figure 7.

Over-current Sequence

A short on the load side will lead to an over-current through OUT. If an over-current stays longer than the time t_{del} and t_{ext} , OUT is turned off as shown in the figure below. At the same time STATUS changes its state to indicate an over-current situation to an external controller. STATUS can also be used to drive directly an indicator LED due to its 10mA driving capability. epc701 delivers a constant on-signal, whereas epc703 has a flashing output.

Current Peak at OUT

A short current peak when OUT is turned on, typically generated by a capacitive load, could trigger the short-circuit protection logic. However, if the current peak is shorter than t_{ext} plus t_{del} , the over-current peak will be ignored.

Make sure that the energy drawn by such a current peak does not destroy the internal/external output transistor.

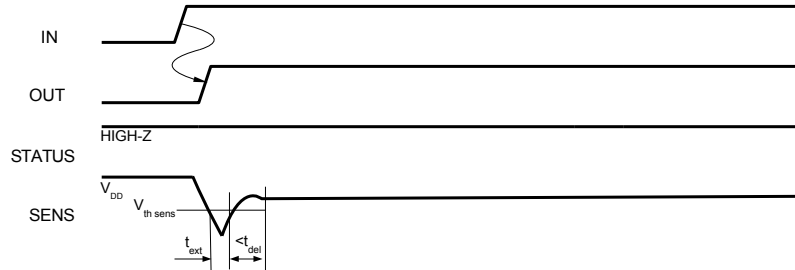

Figure 3: Short over-current pulse, i.e., by switching a capacitive load

Over-current Reset Sequence

If there is a permanent short circuit at OUT, such short circuit will be detected and OUT is turned off. After a waiting time t_{minOFF} , the device tries to turn on OUT again. If the short circuit is still present, OUT is immediately turned off again. This sequence continues until the short circuit is removed or IN goes to LOW or power is turned off. This mode is called self-healing since the device tries to self-heal the short circuit end to switch back into normal operation. As a consequence in the case of a permanent over-current, short current peaks are issued into the load, respectively short.

The time t_{minOFF} has to be set to a value that the internal/external switch cannot be damaged by a too high power dissipation. Without an external switch, the time t_{minOFF} has to be at least 1,000 times longer than the time t_{del} .

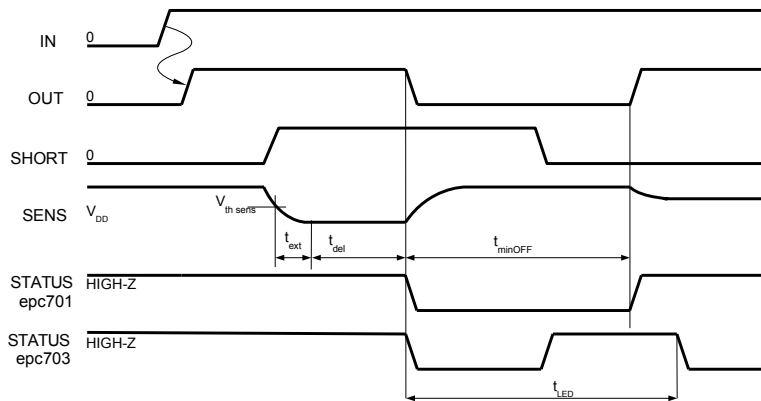

Figure 4: Over-current reset sequence

If one wants to reduce the waiting time in case of a short circuit situation, it can be done by simply taking IN to a low state and then to high again. Please refer to the timing diagram in Figure 5. However, make sure that the maximum power dissipation of the chip or the external switching transistor will never be exceeded above the allowed maximum.

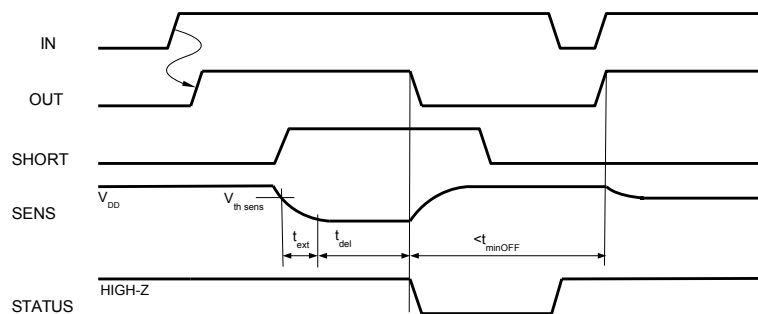

Figure 5: Over-current status reset

Application Information

epc701 and epc703 have two modes of operation, where the SENS pin is used to define the mode. When SENS is tied to GND, the chip operates as a source driver capable to drive max. 50mA at 30VDC (refer to Figure 6). The load is connected directly between the OUT pin and ground GND. If the current through the internal switch exceeds 50mA, the switch is turned off.

If the SENS pin is connected to a shunt resistor R_{SENS} as shown in Figure 7, the OUT pin is driven by a sink driver also capable to drive 50mA to control an external power transistor. This mode is used if the required output current has to be higher than 50mA, e.g. 1A and/or the output voltage exceeds 30VDC.

The load current is measured by monitoring the voltage drop over a resistor. If the internal switch is used, also the current measurement resistor is located internally (Figure 6). In the case of using an external power transistor as shown in Figure 7, the current measurement resistor R_{SENS} has to be placed externally. If the voltage drop at R_{SENS} exceeds the threshold of -200 mV referenced to V_{DD} , the output stage is deactivated. The timing diagrams of the signals can be found in section "Functional Description".

The IN signal must be low during power-up ($t_{STARTUP}$) for proper function of the chip. The epc70x has a built in pull down resistor, so not external active driving is needed during startup.

epc701 or epc703 Using the Internal Switch

Figure 6 shows the epc701/703 in the mode using the internal switch. To enable this mode, the SENS pin has to be connected to GND. Note that the GND of the chip and the GND_L at the load must be connected together direct or with a Schottky diode D1. The factor f_{rt} between minimum off-time and delay-time must be maintained in order not to damage the chip due to overheating. This factor has to be higher than 1,000. In the worst case scenario a peak current of approx. 0.6A is flowing from the load at 30V into the chip with a t_{del} set at 50 μ s if a short-circuit occurs. If the recovery time t_{minoff} in this case is smaller than 50ms, the average power dissipation exceeds the safe operation condition and the device will get damaged.

Diode D_L is to protect the internal switch against voltage surges when inductive loads are turned off.

R_1 is to protect the internal switch in case of a short circuit on the load when a very low impedance power supply is used.

Please note that in this configuration, the GND_L voltage of the load must not be below the GND of the chip. Otherwise, a parasitic diode between GND and OUT turns on and can be damaged. Thus, always connect the GND_L of the load directly with the GND of the chip or with a Schottky diode D1.

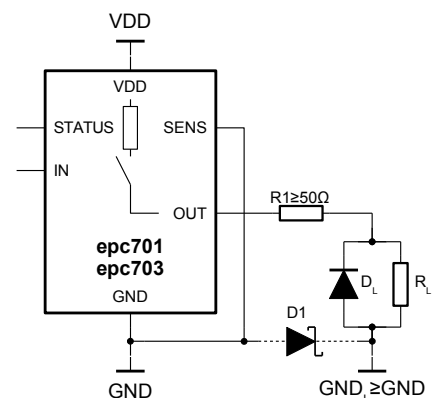

Figure 6: epc701 or epc703 using internal switch to drive a load of up to 50mA/30VDC

epc701 or epc703 Using an External Switching Transistor

Figure 7 shows the operation mode using an external switch T1 in order to extend the output current/voltage drive capability. In this example, a bipolar transistor is used, whereas the base current is limited by the resistor R_1 . The maximum base current is 50mA. In order not to damage the chip, the user has to select the resistor R_1 such that the chip does not need to drive more than 50mA. Possible switches are a PNP BJT or an p-channel MOSFET.

The load is turned on and off by setting the pin IN to high respectively to low level. When the load is turned on, the load current flows from VDD through the resistor R_{SENS} and through transistor T1 to GND_L . This current creates a voltage drop over R_{SENS} . The resulting voltage is applied to pin SENS, which measures the voltage drop. If it exceeds the threshold of an internal comparator, set to -200mV referenced to VDD, the output is turned off after the given delay time t_{del} . If the delay time should be extended to a value above the possible settings of t_{del} (refer to Table 3), an RC network can be added, designated as R_T and C_T in Figure 7. The additional time delay can be calculated approx. as $R_T \times C_T$. However, the time varies according to the current through R_{SENS} . This design concept is especially useful, when a large capacitor in the load path needs to be charged. The additional delay in the over-current detection helps in such a situation.

Note that GND of the chip and GND_L on the load are different in most of the applications. The value of VDD to the chip GND must be between 9.6 and 30V. GND_L of the load instead can be on a level which is appropriate to the external switching transistor.

The diode D_L is to protect the transistor T1 against voltage surges when inductive loads are turned off.

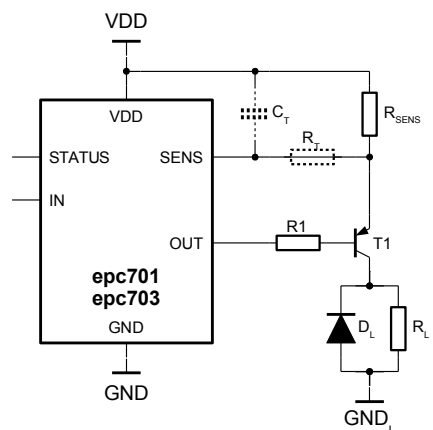

Figure 7: epc701 or epc703 using an external switching transistor. In case of a short-circuit in the load the turn-off delay can be extended by an external RC network. This network adds t_{ext} to the internal delay t_{del} .

Programming

The time delay (t_{del}), until the output is turned off after the detection of an over-current condition can be programmed in order to adapt the timing to specific requirements, i.e., if a capacitive load has to be operated or an external transistor allows other values. The default value is e.g. 50 μ s for the epc701-CSP6-A which allows to charge a load capacitor of approx. 100 – 500nF without an external power transistor, dependent on the source impedance, the load impedance and the voltage V_L .

The time until the output is turned on again after a short circuit can be programmed as well (t_{minOFF}). This “self-healing” mechanism is very useful because no operator interaction is necessary after a short circuit to enable normal function once the short circuit has been eliminated. The default value is e.g. 500ms for the epc701-CSP6-A which means that the device tries to turn the output on after 0.5s waiting time in the short circuit mode. This waiting time is recommended as long as t_{del} is not changed. If t_{del} has been changed, the parameter t_{minOFF} shall be changed accordingly in order to respect parameter f_{rt} . The user has to ensure that the maximum operation conditions are never exceeded in order to avoid damage of the device.

It is to note that the parameters programmed are stored in a volatile random access memory. Thus, the parameters will be lost after a power down for longer than 5ms (data retention time @ 25°C: min. 100ms). The corresponding requirements for safety applications have to take in consideration. Parameters can be changed as many times as necessary and even under operation to change the behavior of an output. During power-on, the default values are restored automatically.

Programming Interface

The interface to store changed parameters are the pins IN and STATUS. IN is the chip select pin and STATUS, which is under normal operation an output, is used as an input pin. As long as the IN pin is at low state, parameters can be stored through the STATUS pin. Since IN is low during the programming of new parameters, OUT is low as well.

The digital input high threshold is typically at 2.2V, thus a 5V compatible communication. Please note that the voltage at STATUS should not exceed 5.5V, referenced to GND.

Single Wire Communication Interface

The epc70x is based on a single wire communication interface by using the STATUS pin. Programming is done by a 21-Bit Manchester code according to IEEE 802.4.

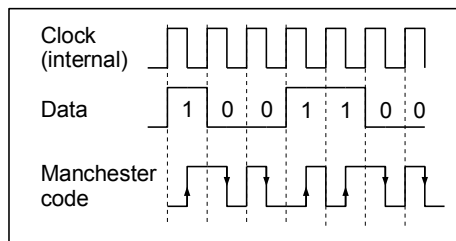

Figure 8: Manchester encoding sample

Figure 8 shows such a sample Manchester encoded data-stream. The clock and the corresponding data is used to generate the Manchester data-stream. Each positive clock-edge in the Manchester encoded data (indicated with the up-arrow) corresponds to a 1 and each negative clock-edge (indicated with the down-arrow) corresponds to a 0.

Data Clock Frequency Range

The communication frequency range has to be according to Table 1.

| | minimal | typical | maximum |
|------------|---------|---------|---------|
| Data clock | 396kHz | 450kHz | 540kHz |

Table 1: Frequency range for programming

Configuration Bit Stream for changing the delay time

In order to guarantee a reliable communication with the Manchester encoded bit stream on STATUS, some additional bits have been added to the configuration bits. Table 2 shows the digital pattern for the delay time configuration and the recovery time configuration.

| Bit # | 0 | 1 | 2 | 3 | 4 | 5 | 6 | 7 | 8 | 9 | 10 | 11 | 12 | 13 | 14 | 15 | 16 | 17 | 18 | 19 | 20 |
|--------------------|---|---|---|---|---|---|---|---|---|---|----|----|----|----|----|----|----|----|----|----|----|
| t_{del} Value | 1 | 0 | 1 | 1 | 0 | 0 | 0 | 0 | 0 | 1 | 1 | 1 | 1 | 0 | D1 | D2 | D3 | 1 | d1 | d2 | d3 |
| T_{minOFF} Value | 1 | 0 | 1 | 1 | 0 | 0 | 0 | 0 | 1 | 0 | 0 | 0 | 1 | 0 | O1 | O2 | O3 | 1 | o1 | o2 | o3 |

Table 2: Configuration of the delay and the recovery time

The delay time is set with d_1 , d_2 , and d_3 . The bits D_1 , D_2 , and D_3 are the inverted values of d_1 , d_2 , and d_3 . Table 3 shows the value mapping table for the 8 different delay times.

| delay [μ s] | D1 | D2 | D3 | d1 | d2 | d3 | Comments |
|------------------|----|----|----|----|----|----|---------------|
| 50 | 1 | 1 | 1 | 0 | 0 | 0 | |
| 5 | 1 | 1 | 0 | 0 | 0 | 1 | |
| 10 | 1 | 0 | 1 | 0 | 1 | 0 | |
| 20 | 1 | 0 | 0 | 0 | 1 | 1 | |
| 100 | 0 | 1 | 1 | 1 | 0 | 0 | Default value |
| 200 | 0 | 1 | 0 | 1 | 0 | 1 | |
| 500 | 0 | 0 | 1 | 1 | 1 | 0 | |
| 1000 | 0 | 0 | 0 | 1 | 1 | 1 | |

Table 3: Delay-time programming table

An un-configured chip is applying a default delay time of 50 μ s corresponding to $[d_1, d_2, d_3] = 000$ and $[D_1, D_2, D_3] = 111$.

The recovery time is set to o_1 , o_2 , and o_3 , resp. O_1 , O_2 , and O_3 which are the inverted values of o_1 , o_2 , and o_3 . Table 4 shows the value mapping table for the 8 different recovery time delay values.

| Recovery time [ms] | O ₁ | O ₂ | O ₃ | o ₁ | o ₂ | o ₃ | Comments |
|--------------------|----------------|----------------|----------------|----------------|----------------|----------------|---------------|
| 500 | 1 | 1 | 1 | 0 | 0 | 0 | |
| 10 | 1 | 1 | 0 | 0 | 0 | 1 | |
| 20 | 1 | 0 | 1 | 0 | 1 | 0 | Default value |
| 50 | 1 | 0 | 0 | 0 | 1 | 1 | |
| 100 | 0 | 1 | 1 | 1 | 0 | 0 | |
| 200 | 0 | 1 | 0 | 1 | 0 | 1 | |
| 1000 | 0 | 0 | 1 | 1 | 1 | 0 | |
| 1500 | 0 | 0 | 0 | 1 | 1 | 1 | |

Table 4: Recovery time programming table

An un-configured chip is applying the default recovery time of 500ms corresponding to $[o_1, o_2, o_3] = 000$ and $[O_1, O_2, O_3] = 111$.

Programming Example

An example for changing the delay time to 100 μ s is shown in the following diagram:

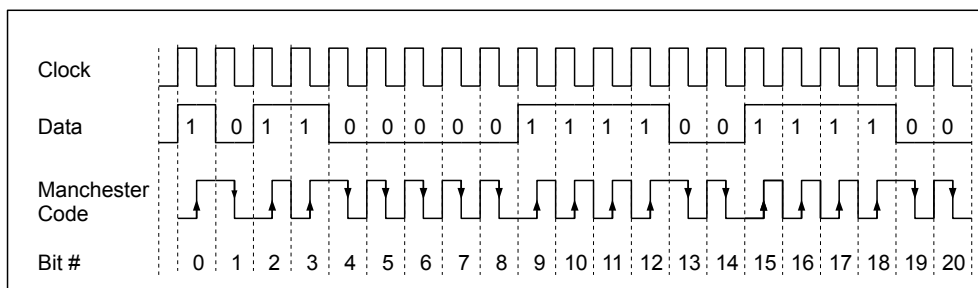

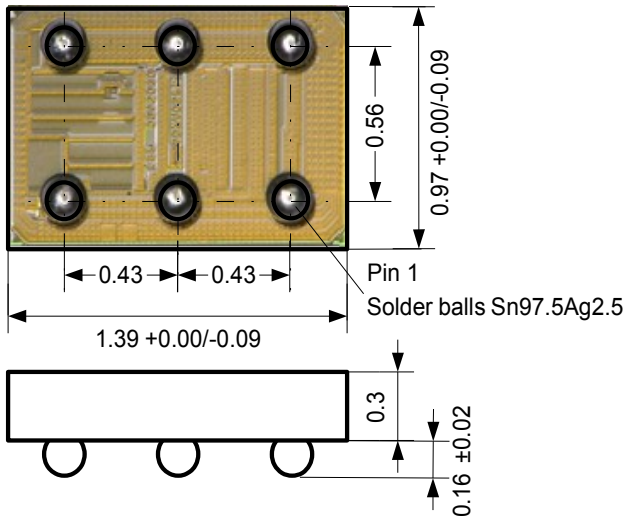

Figure 9: Programming example to set t_{del} to 100 μ s

Layout Information (all measures in mm, )

CSP-6 Package

Mechanical Dimensions



Layout Recommendations

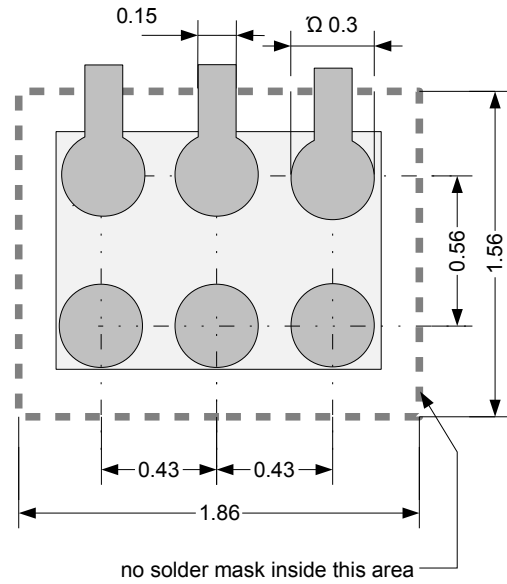

QFN-16 Package

Note: For sampling only. Limited quantities. Please inquire.

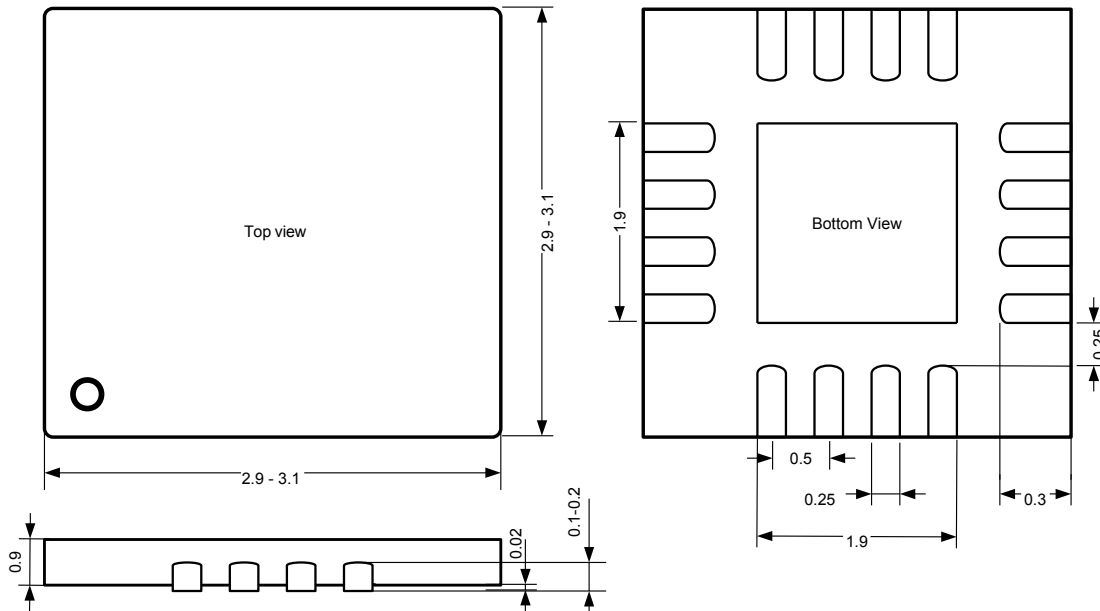

Reflow Solder Profile

For infrared or conventional soldering the solder profile has to follow the recommendations of IPC/JEDEC J-STD-020C (min. revision C) for Pb-free assembly for both types of packages. The peak soldering temperature (T_L) should not exceed +260°C for a maximum of 4 sec.

Packaging Information (all measures in mm)

Tape & Reel Information

The devices are packaged into embossed tapes for automatic placement systems. The tape is wound on 178 mm (7 inch) or 330 mm (13 inch) reels and individually packaged for shipment. General tape-and-reel specification data are available in a separate data sheet and indicate the tape sizes for various package types. Further tape-and-reel specifications can be found in the Electronic Industries Association (EIA) standard 481-1, 481-2, 481-3.

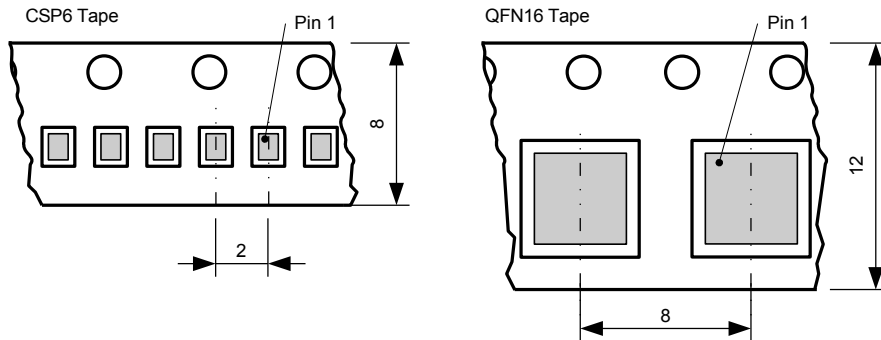

epc does not guarantee that there are no empty cavities in the tape. Thus, the pick-and-place machine should check the presence of a chip during picking.

Ordering Information

Standard products:

| Part Number | Part Name | Package | RoHS compliance | Packaging Method |
|-------------|-------------|---------|-----------------|------------------|
| P100 009 | epc700-CSP6 | CSP6 | Yes | Reel |
| P100 039 | epc701-CSP6 | CSP6 | Yes | Reel |
| P100 059 | epc702-CSP6 | CSP6 | Yes | Reel |
| P100 060 | epc703-CSP6 | CSP6 | Yes | Reel |

QFN package for sampling only. Limited quantities. Please inquire.

| Part Number | Part Name | Package | RoHS compliance | Packaging Method |
|-------------|--------------|---------|-----------------|------------------|
| P100 038 | epc700-QFN16 | QFN16 | Yes | Reel |
| P100 040 | epc701-QFN16 | QFN16 | Yes | Reel |
| P100 057 | epc702-QFN16 | QFN16 | Yes | Reel |
| P100 058 | epc703-QFN16 | QFN16 | Yes | Reel |

IMPORTANT NOTICE

ESPROS Photonics AG and its subsidiaries (epc) reserve the right to make corrections, modifications, enhancements, improvements, and other changes to its products and services at any time and to discontinue any product or service without notice. Customers should obtain the latest relevant information before placing orders and should verify that such information is current and complete. All products are sold subject to epc's terms and conditions of sale supplied at the time of order acknowledgment.

epc warrants performance of its hardware products to the specifications applicable at the time of sale in accordance with epc's standard warranty. Testing and other quality control techniques are used to the extent epc deems necessary to support this warranty. Except where mandated by government requirements, testing of all parameters of each product is not necessarily performed.

epc assumes no liability for applications assistance or customer product design. Customers are responsible for their products and applications using epc components. To minimize the risks associated with customer products and applications, customers should provide adequate design and operating safeguards.

epc does not warrant or represent that any license, either express or implied, is granted under any epc patent right, copyright, mask work right, or other epc intellectual property right relating to any combination, machine, or process in which epc products or services are used. Information published by epc regarding third-party products or services does not constitute a license from epc to use such products or services or a warranty or endorsement thereof. Use of such information may require a license from a third party under the patents or other intellectual property of the third party, or a license from epc under the patents or other intellectual property of epc.

Resale of epc products or services with statements different from or beyond the parameters stated by epc for that product or service voids all express and any implied warranties for the associated epc product or service. epc is not responsible or liable for any such statements.

epc products are not authorized for use in safety-critical applications (such as life support) where a failure of the epc product would reasonably be expected to cause severe personal injury or death, unless officers of the parties have executed an agreement specifically governing such use. Buyers represent that they have all necessary expertise in the safety and regulatory ramifications of their applications, and acknowledge and agree that they are solely responsible for all legal, regulatory and safety-related requirements concerning their products and any use of epc products in such safety-critical applications, notwithstanding any applications-related information or support that may be provided by epc. Further, Buyers must fully indemnify epc and its representatives against any damages arising out of the use of epc products in such safety-critical applications.

epc products are neither designed nor intended for use in military/aerospace applications or environments unless the epc products are specifically designated by epc as military-grade or "enhanced plastic." Only products designated by epc as military-grade meet military specifications. Buyers acknowledge and agree that any such use of epc products which epc has not designated as military-grade is solely at the Buyer's risk, and that they are solely responsible for compliance with all legal and regulatory requirements in connection with such use.

epc products are neither designed nor intended for use in automotive applications or environments unless the specific epc products are designated by epc as compliant with ISO/TS 16949 requirements. Buyers acknowledge and agree that, if they use any non-designated products in automotive applications, epc will not be responsible for any failure to meet such requirements.