

Solid State Relays 3-Phase with Integrated Heatsink Proportional Switching Controllers Types RGC2P, RGC3P



- 2-pole and 3-pole analog switching solid state contactors
- Rated operational voltage: up to 660VAC
- Rated operational current: up to 75AAC
- Control inputs: 0-20mA, 4-20mA, 12-20mA, 0-5V, 1-5V, 0-10V
- Local setting through external potentiometer
- Switching modes: phase angle or distributed full cycles (1, 4 or 16 full cycles)
- Soft start feature with selectable ramp time up to 5 seconds
- Integrated varistor protection on output
- Monitoring for SSR and load malfunction
- EMR output for alarm indication
- 100kA short circuit current rating according to UL508
- DIN or panel mount



Product Description

This series gives the possibility to control output power of 3-phase loads with an analog control input. The RGC2P is a 2-phase switching product whilst the RGC3P switches all 3 phases.

Input types cover a wide range of current and voltage ranges. Local setting by an external potentiometer is also possible. Switching modes cover phase angle control, distributed full

cycle control and soft start for limiting inrush current of loads having a high temperature coefficient, such as short wave infrared heaters.

Detection of mains loss, load loss, SSR short circuit and over-temperature is integrated in some models. Alarm condition is signalled through an EMR output and is visually indicated by the alarm LED. Additional LEDs indicate input and load status.

Ordering Key **RGC 3 P 60 V 65 C1 D F M**

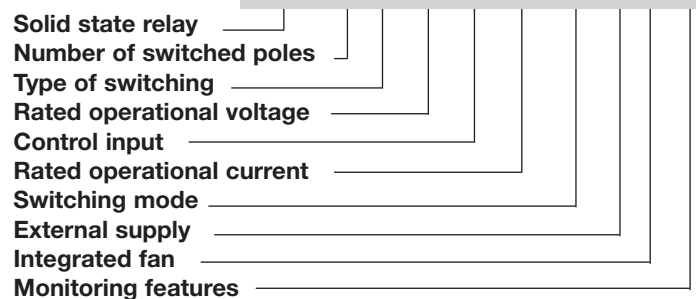

Specifications are at a surrounding temperature of 25°C unless otherwise specified.

Ordering Key (Refer to page 4 for valid part numbers)

SSR with heatsink	Type of switching	Rated voltage (Ue), Blocking voltage	Control input ¹	Rated current/ pole @40°C ²	Switching mode	External supply (Us)	Features
RGC2: 2-pole switching + 1-pole direct	P: Proportional	60: 180 - 660VAC, 1200Vp	AA: 4-20mADC I: 0-20mADC 4-20mADC 12-20mADC V: 0-5VDC 1-5VDC 0-10VDC	15: 15AAC 25: 25AAC 40: 40AAC 75: 75AAC	C1: 1 FC ON, 1FC OFF @ 50% input C4: 4 FC ON, 4FC OFF @ 50% input	D: 24VAC/DC A: 90 - 250VAC	F: Integrated fan M: Monitoring for Mains loss, Load loss, SSR short circuit, open circuit and OTP with EMR alarm output
RGC3: 3-pole switching	P: Proportional	60: 180 - 660VAC, 1200Vp	AA: 4-20mADC I: 0-20mADC 4-20mADC 12-20mADC V: 0-5VDC 1-5VDC 0-10VDC	20: 20AAC 30: 30AAC 65: 65AAC	E: Phase Angle C1: 1 FC ON, 1FC OFF @ 50% input C4: 4 FC ON, 4FC OFF @ 50% input C16: 16 FC ON, 16FC OFF @ 50% input S: Soft Start S16: Soft Start + mode C16	D: 24VAC/DC A: 90 - 250VAC	P: Integrated over temperature protection (OTP), mains loss with EMR alarm output F: Integrated fan M: Monitoring for Mains loss, Load loss, SSR short circuit, open circuit and OTP with EMR alarm output

FC = Full Cycle
OTP = Over Temperature Protection
EMR = Electromechanical Relay
1. Input types I and V require an external supply Us
2. Refer to Derating Curves

Switching Modes

PHASE ANGLE switching - Mode E

The Phase angle switching mode works in accordance with the phase angle control principle. The power delivered to the load is controlled by the firing of the thyristors over each half supply cycle. The firing angle varies in relation to the input signal level which determines the output power to be delivered to the load.

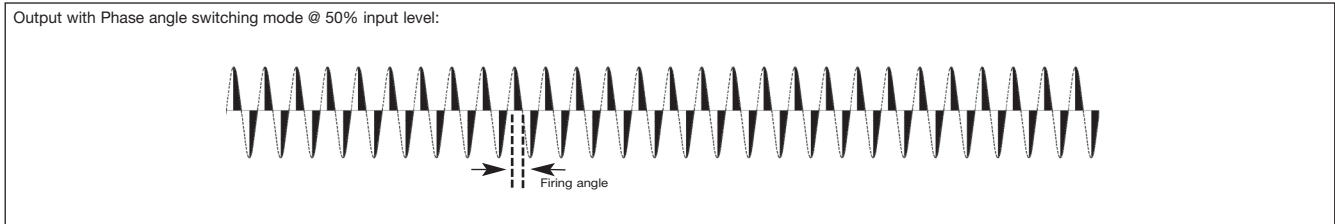

FULL CYCLE switching:

Single full cycle switching - Mode C1

In this switching mode only full cycles are switched. The number of full cycles delivered to the load over a specific time base is determined by the level of the analog input. The full cycles are DISTRIBUTED over this time base so as to ensure a fast and accurate control of the load. In mode C1, the switching resolution is 1 full cycle. Hence, @ an input level of 50% the output switching will be 1FC ON, 1FC OFF, @ 25% input 1FC ON, 3FC OFF and @ 75% input 1FC OFF, 3FC ON as shown in figure below.

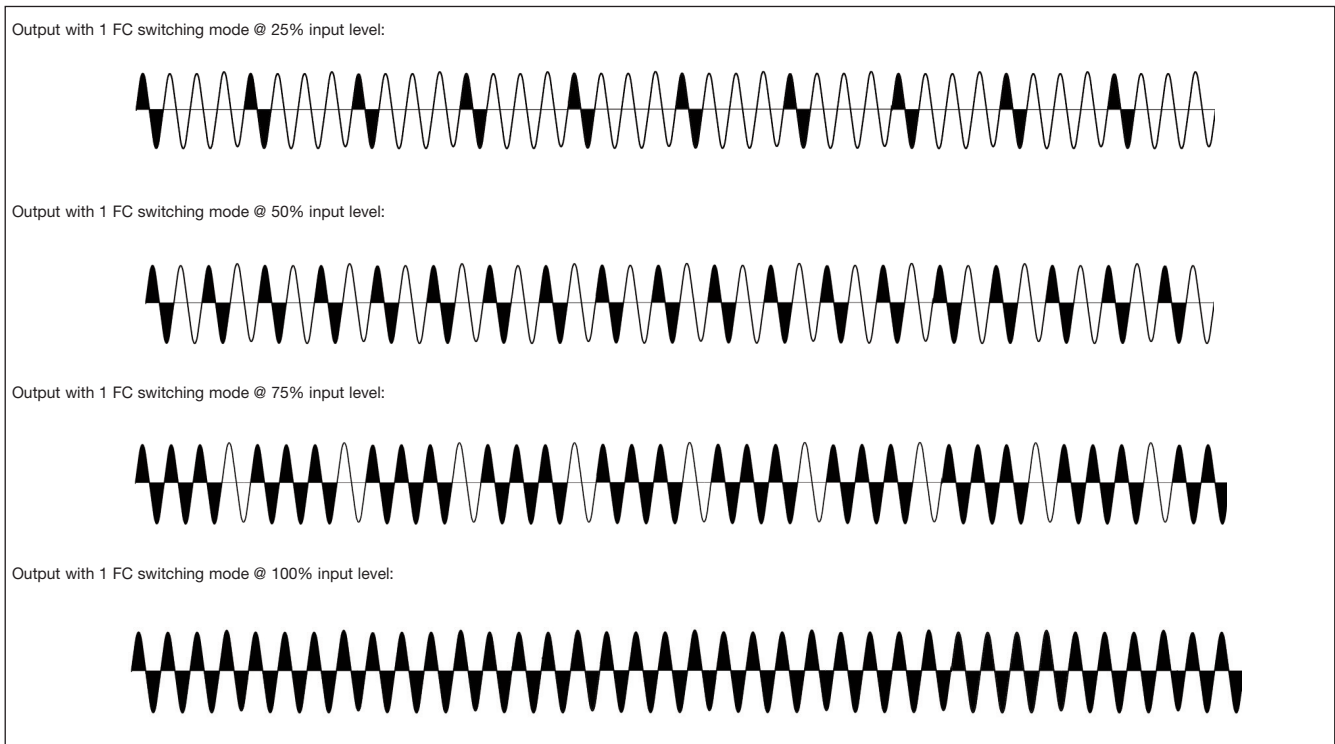

Burst full cycle switching - Mode C4 and Mode C16

The modes C4 and C16 work on the same principle of the C1 mode and hence a number of full cycles are switched in accordance to the input level distributed over a specific time base. In the case of mode C4 the lowest resolution is 4 full cycles whilst for mode C16 it is 16 full cycles. These modes are suitable for loads which have a low thermal inertia.

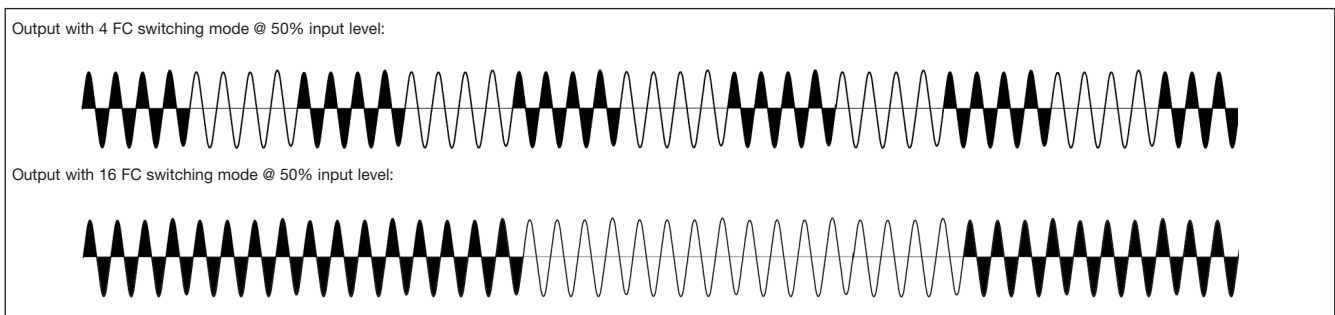

Switching Modes (continued)

SOFT START switching:

In this mode the thyristor firing angle is gradually increased in order to apply the voltage (and current) to the load smoothly and thus reduce the start-up current of loads which have a high cold to hot resistance ratio such as short wave infrared heaters.

Soft start with digital input - Mode S

On power up, the RGC3P60V..S.. performs a soft start as soon as a control input is applied. The ramp time can be set to a maximum of 5 seconds through an onboard potentiometer. After the ramp is completed, full cycles are delivered to the output as long as a control voltage (between 5 - 10V) is present on terminals A1-A4. Soft start is not performed every time the control input is applied but only in the cases where firing has been cut off for more than 5 seconds. If for some reason ramping is stopped before ramp completion, a start is assumed to have been performed and hence the 5 seconds count start once ramping is stopped.

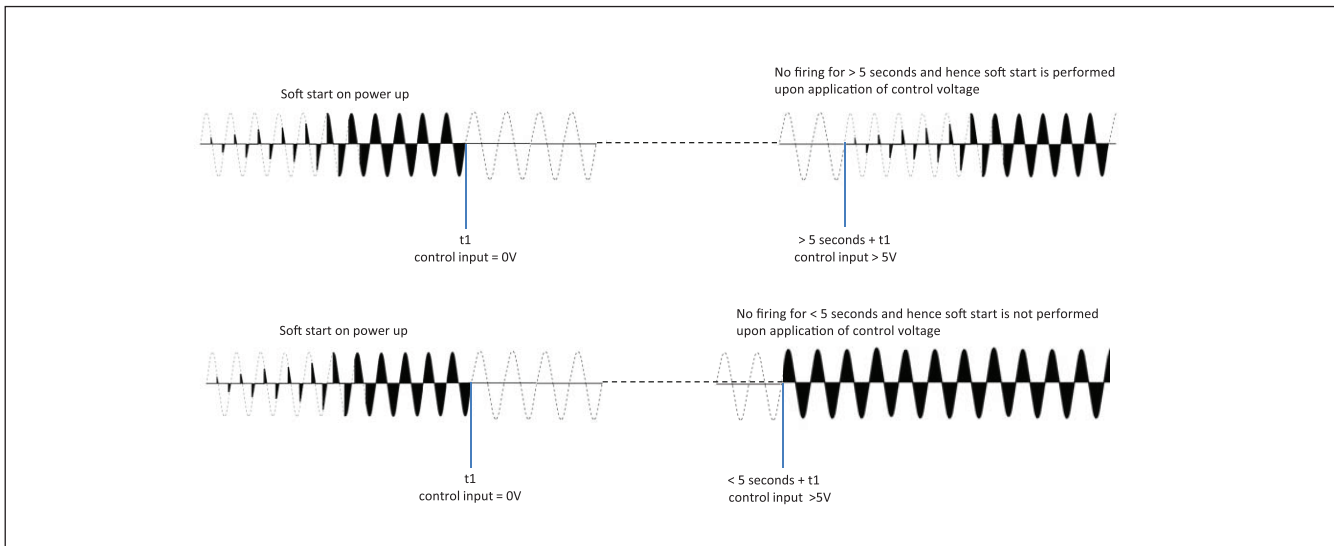

Soft start with analog input - Mode S16

This switching mode is a combination of 2 switching modes described above and hence soft start with mode S and full cycle control with mode C16. The RGC3P60V..S16 switching mode works on the principle of the mode C16 but on power up soft starting is performed to limit inrush currents loads which have a low resistance when cold. After the soft start is completed, where ramping time can be set to maximum of 5 seconds through an onboard potentiometer, the mode C16 comes into affect. Full cycles are thus delivered to the load in accordance to the input level. Soft starting is performed on power up and in case firing has been cut in the previous 5 seconds. If for some reason ramping is stopped before ramp completion, a start is assumed to have been performed and hence the 5 seconds count start once ramping is stopped.

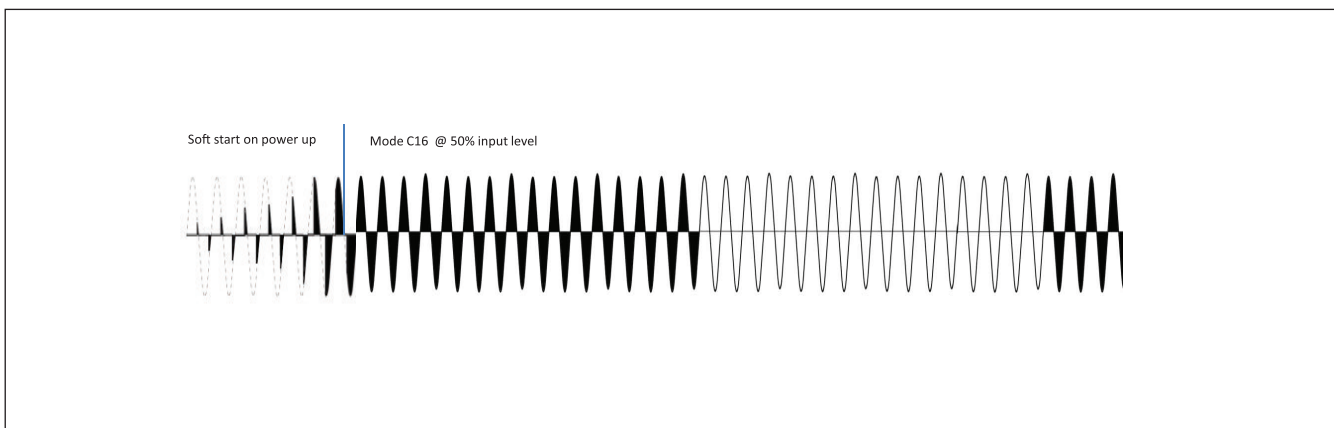

Selection Guide: RGC2P

Current rating @ 40°C	Input type	External supply	Switching mode					
			E	C1	C4	C16	S	S16
15AAC 1,800A ² s	AA	-	-	RGC2P60AA15C1	-	-	-	-
	AA	-	-	RGC2P60AA25C1	-	-	-	-
25AAC 1,800A ² s	I	DC	-	RGC2P60I25C1DM	RGC2P60I25C4DM	-	-	-
	V	DC	-	RGC2P60V25C1DM	-	-	-	-
40AAC 6,600A ² s	AA	-	-	RGC2P60AA40C1	-	-	-	-
	I	DC	-	RGC2P60I40C1DM	RGC2P60I40C4DM	-	-	-
	V	DC	-	RGC2P60V40C1DM	-	-	-	-
75AAC 15,000A ² s	I	DC	-	RGC2P60I75C1DFM	RGC2P60I75C4DFM	-	-	-
		AC	-	RGC2P60I75C1AFM	RGC2P60I75C4AFM	-	-	-
	V	DC	-	RGC2P60V75C1DFM	-	-	-	-
		AC	-	RGC2P60V75C1AFM	-	-	-	-

Selection Guide: RGC3P

Current rating @ 40°C	Input type	External supply	Switching mode					
			E	C1	C4	C16	S	S16
20AAC 1,800A ² s	AA	-	RGC3P60AA20E	RGC3P60AA20C1	-	-	-	-
	I	DC	RGC3P60I20EDP	RGC3P60I20C1DM	RGC3P60I20C4DM	RGC3P60I20C16DM	-	-
	V	DC	RGC3P60V20EDP	RGC3P60V20C1DM	RGC3P60V20C4DM	RGC3P60V20C16DM	-	RGC3P60V20S16DM
	5-10V digital i/p	DC	-	-	-	-	RGC3P60V20SDM	-
30AAC 6,600A ² s	AA	-	RGC3P60AA30E	RGC3P60AA30C1	-	-	-	-
	I	DC	RGC3P60I30EDP	RGC3P60I30C1DM	RGC3P60I30C4DM	RGC3P60I30C16DM	-	-
		AC	RGC3P60I30EAP	RGC3P60I30C1AM	RGC3P60I30C4AM	RGC3P60I30C16AM	-	-
	V	DC	RGC3P60V30EDP	RGC3P60V30C1DM	RGC3P60V30C4DM	RGC3P60V30C16DM	-	RGC3P60V30S16DM
		AC	RGC3P60V30EAP	RGC3P60V30C1AM	RGC3P60V30C4AM	RGC3P60V30C16AM	-	-
65AAC 15,000A ² s	5-10V digital i/p	DC	-	-	-	-	RGC3P60V30SDM	-
	I	DC	RGC3P60I65EDFP	RGC3P60I65C1DFM	RGC3P60I65C4DFM	RGC3P60I65C16DFM	-	-
		AC	RGC3P60I65EAFP	RGC3P60I65C1AFM	RGC3P60I65C4AFM	RGC3P60I65C16AFM	-	-
	V	DC	RGC3P60V65EDFP	RGC3P60V65C1DFM	RGC3P60V65C4DFM	RGC3P60V65C16DFM	-	RGC3P60V65S16DFM
		AC	RGC3P60V65EAFP	RGC3P60V65C1AFM	RGC3P60V65C4AFM	RGC3P60V65C16AFM	-	-
	5-10V digital i/p	DC	-	-	-	-	RGC3P60V65SDFM	-

Input type

AA: 4-20 mADC
I: 0-20, 4-20, 12-20 mADC
V: 0-10, 0-5, 1-5 VDC

External supply

DC: 24VAC/DC
AC: 90-250VAC

Switching mode

E: Phase Angle
C1: 1 Full Cycle
C4: 4 Full Cycles
C16: 16 Full Cycles
S: Soft Start
S16: Soft Start + 16 Full Cycles

General Specifications

	RGC..AA..	RGC..I..	RGC..V..
Latching voltage (across each pole L-T)	20V		
Operational frequency range	45 to 65Hz		
Power factor	> 0.7 @ rated voltage		
Output Power	0 to 100%		
Touch Protection	IP20		
CE marking	Yes		
Pollution degree	2 (non-conductive pollution with possibilities of condensation)		
Over-voltage category	III (fixed installations), 6kV (1.2 / 50 µs) rated impulse withstand voltage Uimp		
LED status indication			
Control ON	Green <4mA, flashing 0.5s ON, 0.5s OFF >4mA, intensity varies with input	Green Full intensity	Green Full intensity
Supply ON	n/a	Green Flashing 0.5s ON, 0.5s OFF	Green Flashing 0.5s ON, 0.5s OFF
Load ON	n/a	Yellow ON according to load status	Yellow ON according to load status
Alarm ON	Green, flashing ³	Red, flashing ³	Red, flashing ³
Isolation			
Input & Output to Case	4000Vrms	4000Vrms	4000Vrms
Input to Output	2500Vrms	2500Vrms	2500Vrms
External supply to input Us to A1, A2, A3, A4, A5, Uf, 11, 12, 14, C1, C2	n/a	1500Vrms	1500Vrms
External supply & input to EMR Us, A1, A2, A3, A4, A5, Uf, C1, C2 to 11, 12, 14	n/a	1500Vrms	1500Vrms

3: Refer to LED Indications

Output Voltage Specifications

Operational voltage range	
Line to line voltage, L1/L2/L3	180-660 VAC
Permissible voltage unbalance	10% between L1/L2/L3
Blocking voltage	1200Vp
Leakage current @ rated voltage	5mAAC per pole
Internal Varistors (across each pole)	Yes

Output Specifications: RGC2

	RGC2..15	RGC2..25	RGC2..40	RGC2..75
Rated operational current per pole ⁴				
AC-51 @ Ta=25°C	15 AAC	32 AAC	50 AAC	85 AAC
AC-51 @ Ta=40°C	15 AAC	27 AAC	40 AAC	75 AAC
AC-55b @ Ta=40°C ⁵	15 AAC	27 AAC	40 AAC	75 AAC
Minimum operational current	500 mAAC	500 mAAC	1AAC	1 AAC
Number of starts ⁵	130	35	10	240
Rep. Overload Current PF = 0.7 UL508: Ta=40°C, t _{ON} =1s, t _{OFF} =9s, 50cycles	61 AAC	61 AAC	107 AAC	154 AAC
Maximum transient surge current (I _{tsm}), t=10ms	600 Ap	600 Ap	1150 Ap	1750 Ap
I ² t for fusing (t=10ms), minimum	1800 A ² s	1800 A ² s	6600 A ² s	15000 A ² s
Critical dv/dt (@ T _j init = 40°C)	1000 V/μs	1000 V/μs	1000 V/μs	1000 V/μs

4: Refer to Derating Curves

5: Overload profile for AC-55b, I_e: AC-55b: 6x I_e - 0.2: 80 - x, where I_e = nominal current (AAC), 6xI_e = overload current (AAC), 0.2 = duration of overload current (s), 80 = ON duty cycle (%), x= number of starts. The overload profile for RGC2..75 is AC-55b: 3.2x I_e - 0.2: 80 - x

Output Specifications: RGC3

	RGC3..20	RGC3..30	RGC3..65
Rated operational current per pole ⁴			
AC-51 @ Ta=25°C	25 AAC	37 AAC	71 AAC
AC-51 @ Ta=40°C	20 AAC	30 AAC	66 AAC
AC-55b @ Ta=40°C ⁵	20 AAC	30 AAC	66 AAC
Minimum operational current	500 mACC	1AAC	1 AAC
Number of starts ⁵	140	18	230
Rep. Overload Current PF = 0.7 UL508: Ta=40°C, t _{ON} =1s, t _{OFF} =9s, 50cycles	61 AAC	107 AAC	154 AAC
Maximum transient surge current (I _{tsm}), t=10ms	600 Ap	1150 Ap	1750 Ap
I ² t for fusing (t=10ms), minimum	1800 A ² s	6600 A ² s	15000 A ² s
Critical dv/dt (@ T _j init = 40°C)	1000 V/μs	1000 V/μs	1000 V/μs

4: Refer to Derating Curves

5: Overload profile for AC-55b, I_e: AC-55b: 6x I_e - 0.2: 80 - x, where I_e = nominal current (AAC), 6xI_e = overload current (AAC), 0.2 = duration of overload current (s), 80 = ON duty cycle (%), x= number of starts. The overload profile for RGC3..65 is AC-55b: 3.6x I_e - 0.2: 80 - x

Input Specifications

		RGC..AA..	RGC..I..	RGC..V..
Control input		4 - 20mADC	0 - 20mADC 4 - 20mADC 12 - 20mADC	0 - 5VDC 1 - 5VDC 0 - 10VDC 5 - 10 VDC (digital)
	RGC3P..S			
Drop out voltage	RGC3P..S	-	-	< 4VDC
External potentiometer input		n/a	n/a	10K ohms (terminal A1, A3, A5)
Maximum initialisation time		250ms	250ms	250ms
Response time (Input to Output)	RGC..E, S	2 half cycles	2 half cycles	2 half cycles
	RGC..C1, C4, C16, S16	3 half cycles	3 half cycles	3 half cycles
Input impedance		n/a	<250 ohms	100k ohms
Linearity, Output resolution		Refer to Transfer Characteristics section		
Voltage drop		< 10VDC @ 20mA	n/a	n/a
Reverse protection		Yes	Yes	Yes
Maximum allowable input current		50mA for max. 30 sec.	50mA for max. 30 sec.	n/a
Input protection vs. surges		Yes	Yes	Yes
Overvoltage protection		n/a	n/a	up to 24VDC

Note: Control input serial connection of multiple units is ONLY possible for:

1. RGC..AA versions, and
2. the versions that require an AC external supply and hence the RGC..I..AM, RGC..I..AFM, RGC..I..AP and RGC..I..AFP models

Transfer Characteristics

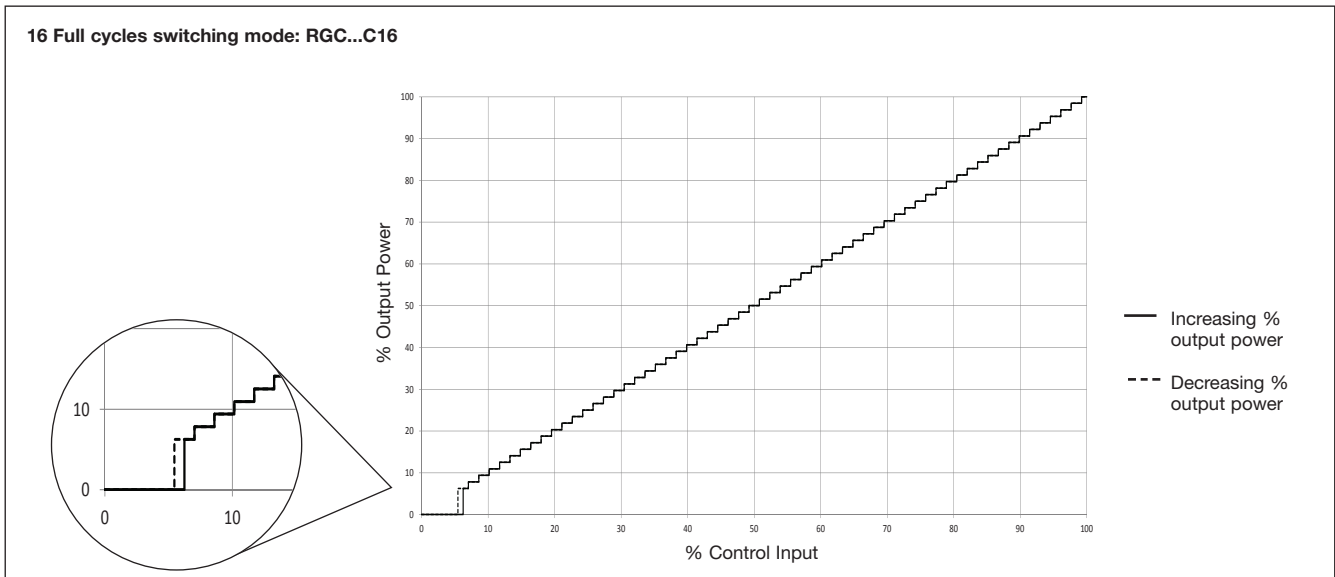
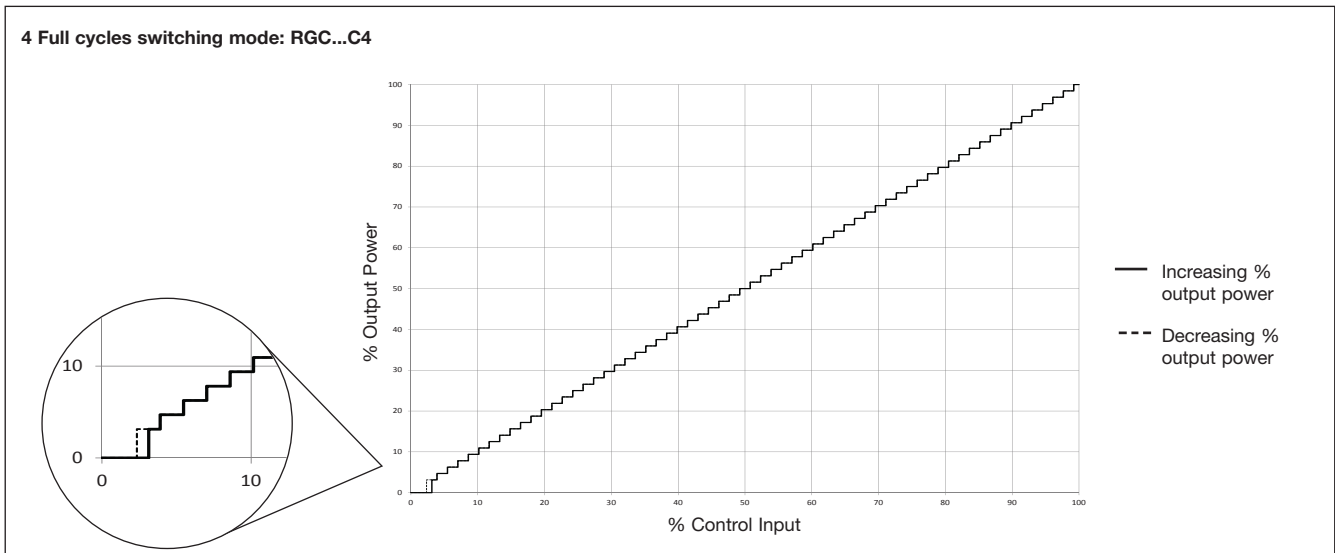
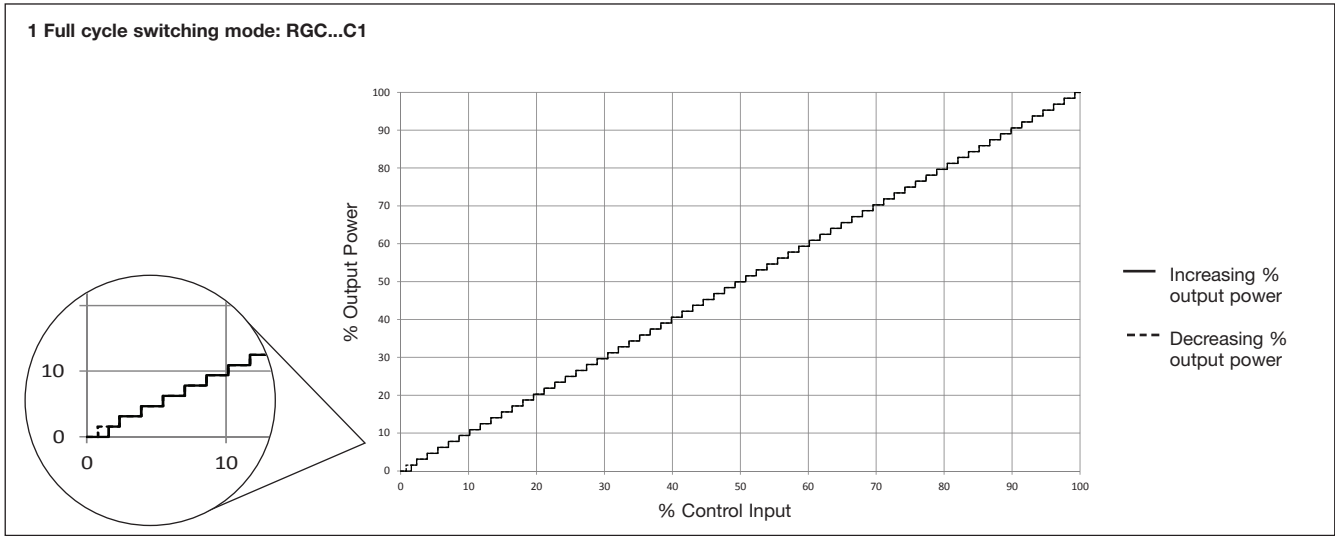

Transfer Characteristics

Phase Angle switching mode: RGC3P.E

3-phase, 3-wire systems

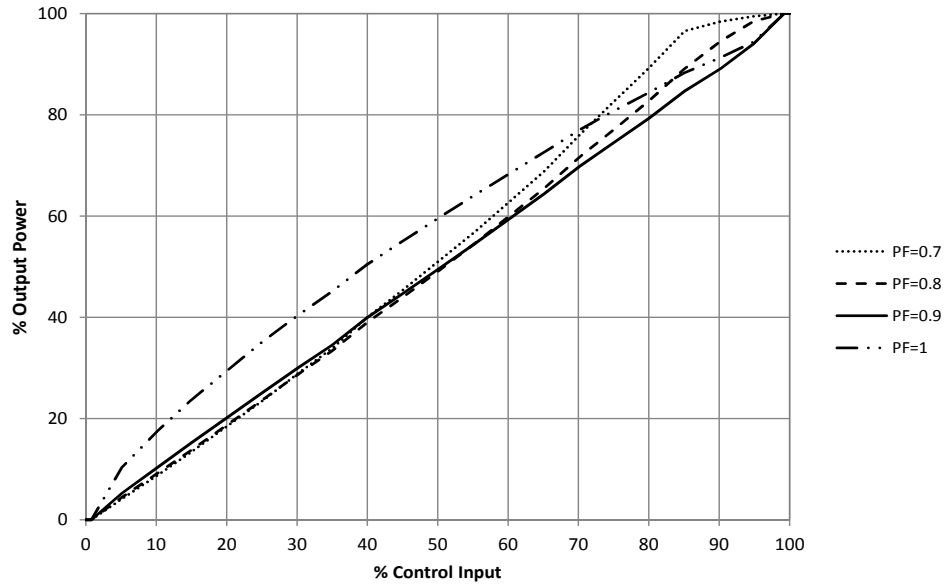

3-phase, 4-wire systems

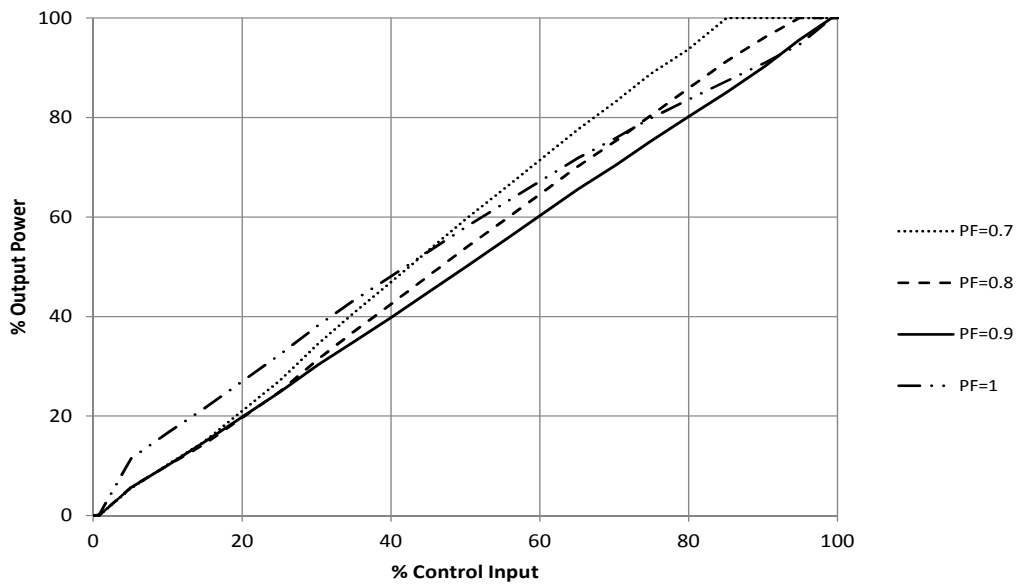

Supply Specifications (Us)

	RGC..D..	RGC..A..
Supply voltage range	24VDC, -15% / +20% 24VAC, -15% / +15%	90-250VAC
Oversoltage protection	up to 32VDC/AC for 30 seconds	n/a
Reverse protection	Yes	n/a
Surge protection	Yes, integrated	Yes
Max. supply current no fan, RGC..P, RGC..M with fan, RGC..FP, RGC..FM	90mA 175mA	30mA 60mA

Alarm Specifications (12, 14, 11)

	RG..P RG..M
Output type	EMR, 1 Form C Normally closed (12-11) Normally open (14-11)
Contact rating	2A @ 250VAC / 30VDC
Isolation between open contacts	1000VAC

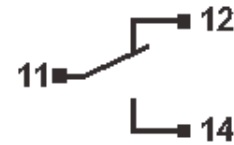

Output Power Dissipation

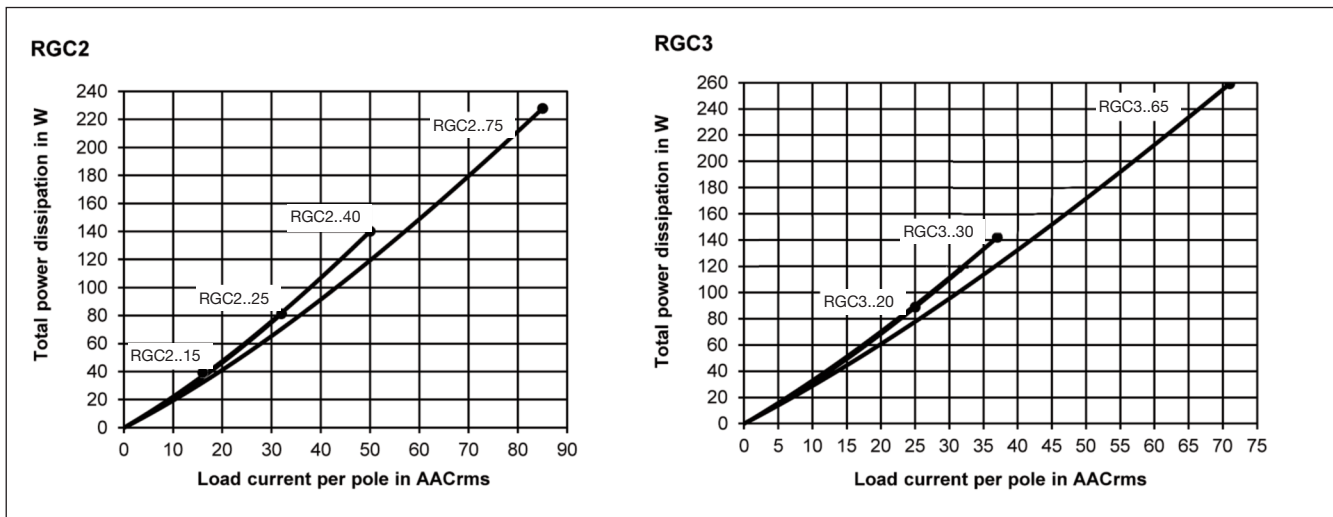

Current Derating

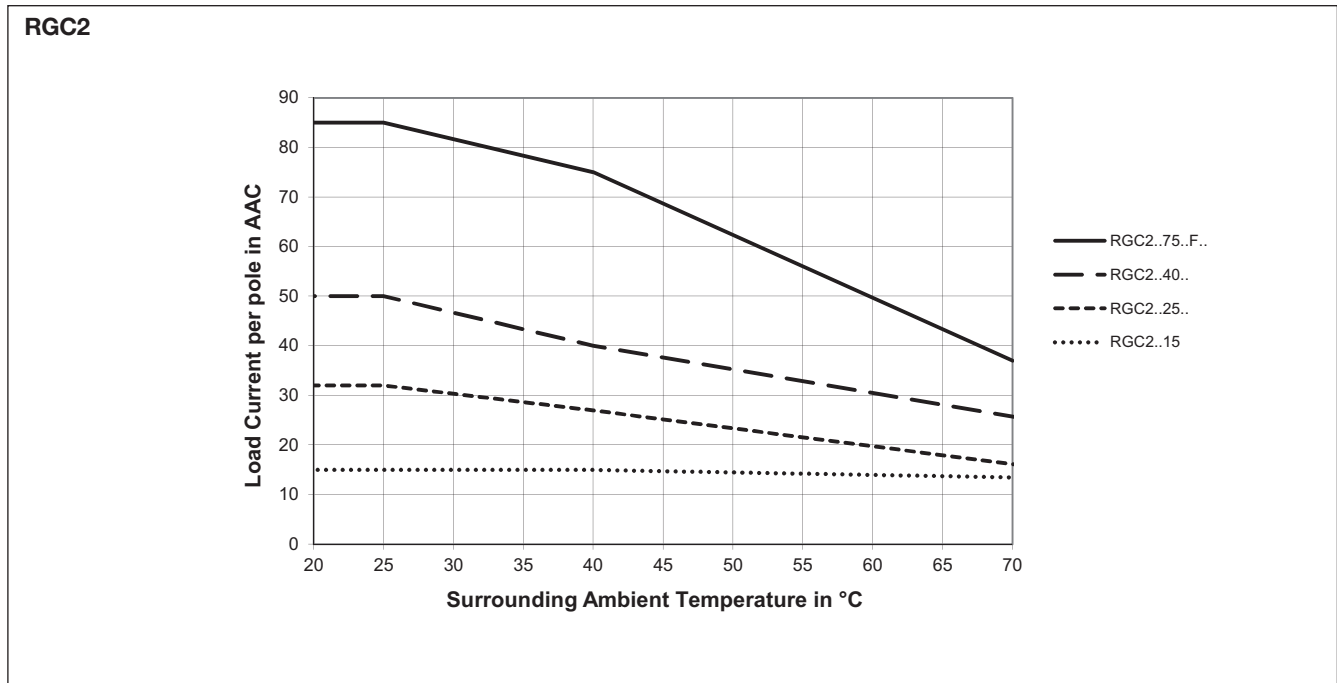

Note: Versions that utilise 24VAC external supply (Us) are limited to a maximum operating temperature of 60°C (140°F)

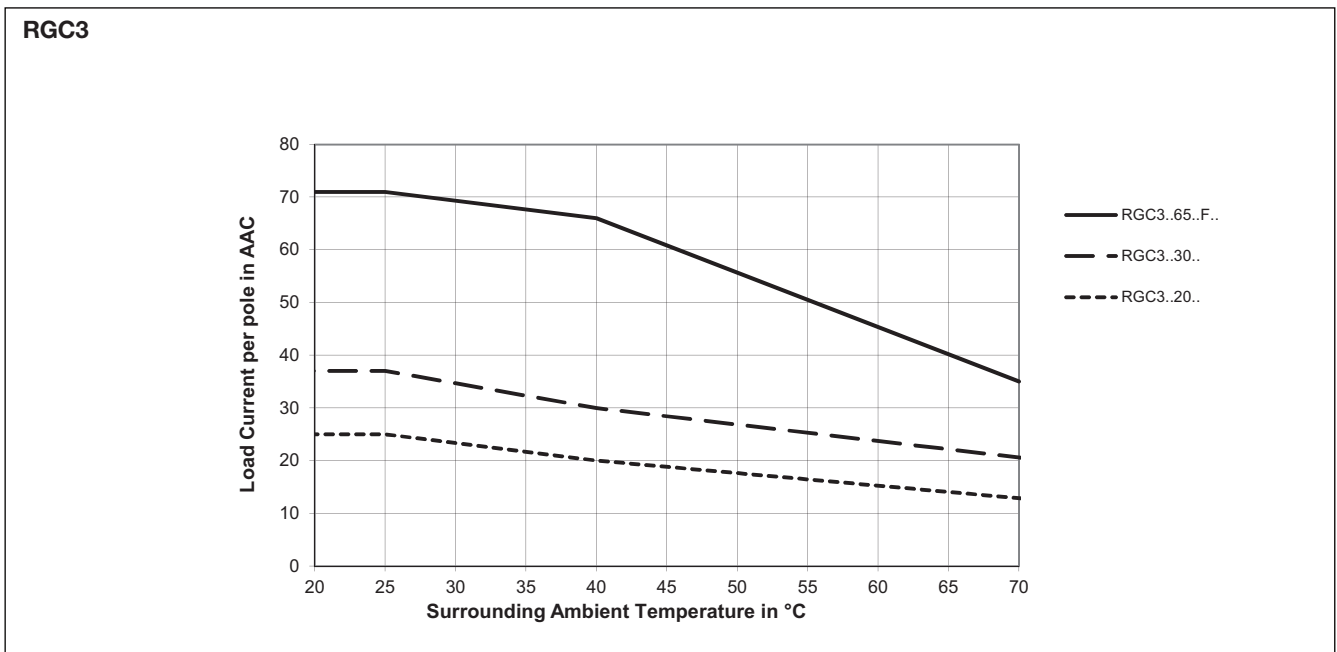

Note: Versions that utilise 24VAC external supply (Us) are limited to a maximum operating temperature of 60°C (140°F)

Current Derating with 0mm spacing

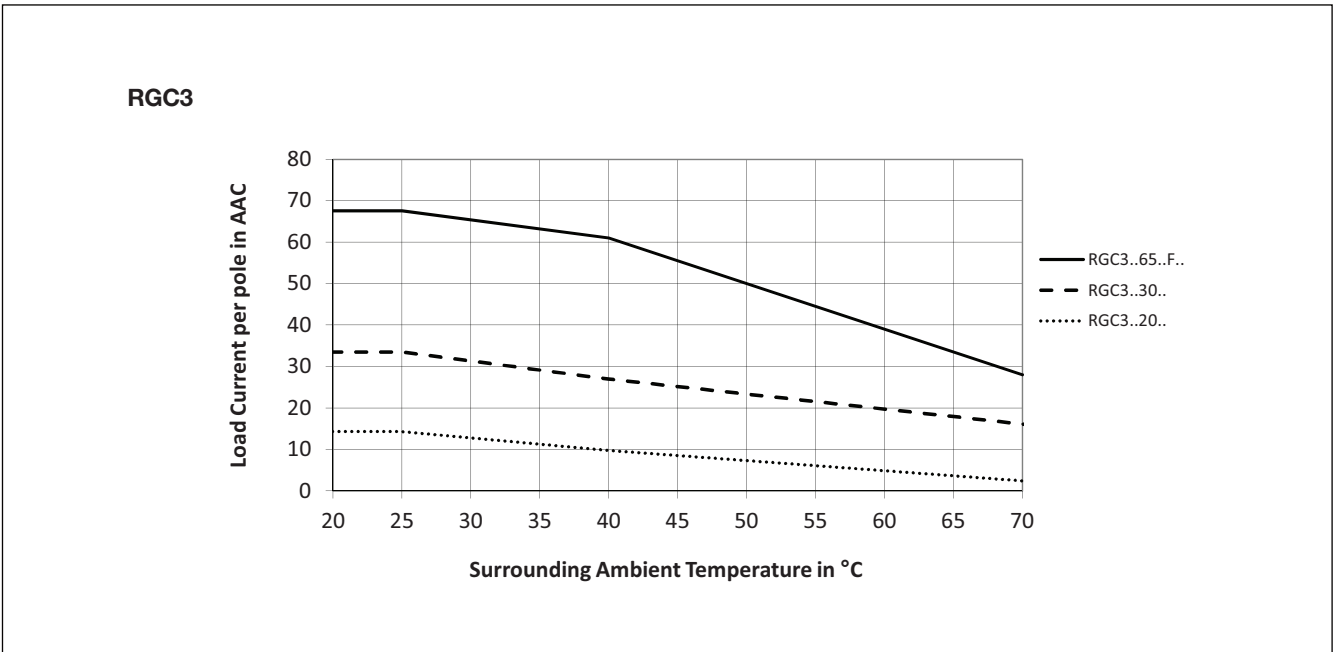
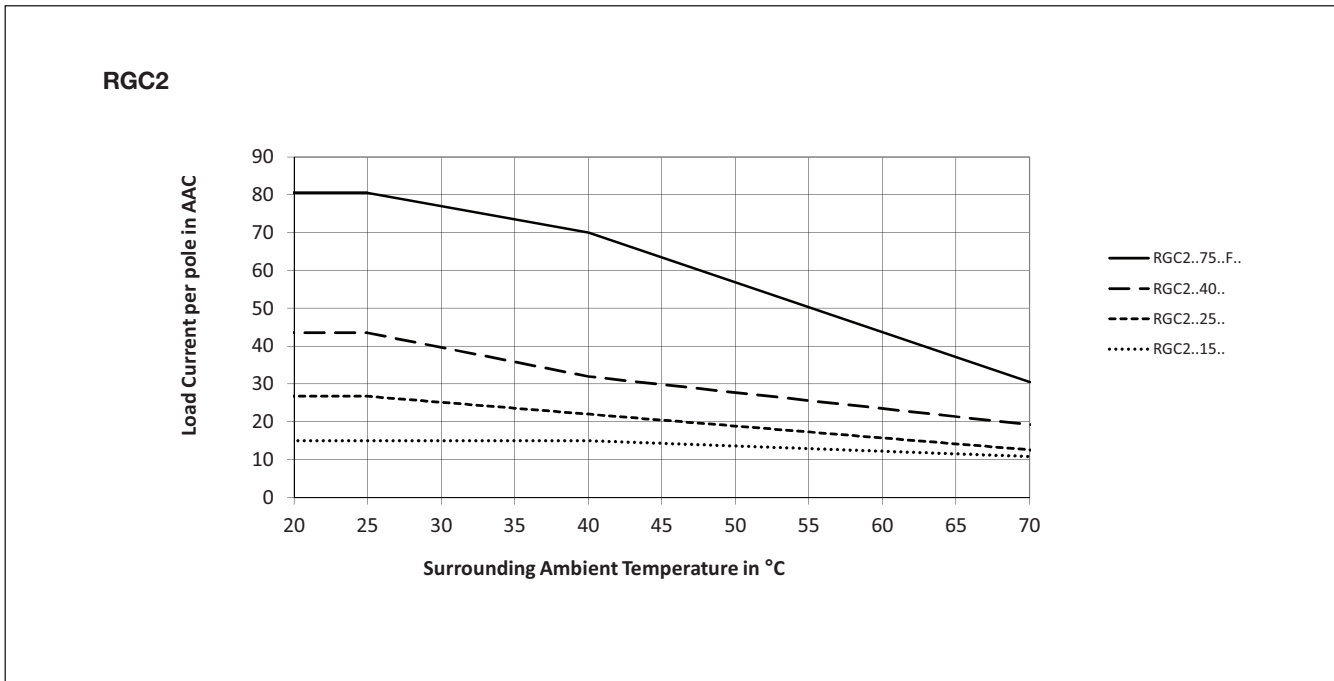

Environmental Specifications

Operating temperature Us=24VAC	-40°C to +70°C (-40°F to +158°F) -40°C to +60°C (-40°F to +140°F)
Storage temperature	-40°C to +100°C (-40°F to +212°F)
EU RoHS compliant	Yes
China RoHS compliant	Refer to Environmental Information (Page 30)
Impact resistance (EN50155, EN61373)	15/11 g/ms
Vibration resistance (2-100Hz, IEC60068-2-6, EN50155, EN61373)	2g per axis
Relative humidity	95% non condensing @ 40°C

UL flammability rating (for plastic)	UL 94 V0 Glow wire ignition temperature, Glow wire flammability index conform to EN 60335-1 requirements
Installation altitude	0 - 1000m. Above 1000m derate linearly by 1% of FLC per 100m up to maximum of 2000m
Weight RGC2..15, RGC2..25 (M) RGC3..20 (M or P) RGC2..40, RGC3..30 (M or P) RGC2..75, RGC3..65	approx. 600g (660g) approx. 600g (670g) approx. 840g (920g) approx. 990g

Agency Approvals and Conformance

Conformance	EN/IEC 60947-4-3	Agency Approvals	UL Listed (E172877), UL508
Short Circuit Current rating	100kArms, UL508		cUL Listed (E172877), C22.2 No.14-13 CCC, GB/T 14048.5-2008 (IEC 60947-5-1)



Electromagnetic Compatibility

EMC immunity	EN 60947-4-3	Electrical fast transient (Burst) immunity	EN/IEC 61000-4-4
Electrostatic discharge (ESD) immunity	EN/IEC 61000-4-2	Output: 2kV, 5kHz	Performance Criteria 1
Air discharge, 8kV	Performance Criteria 2	Input : 1kV, 5kHz	Performance Criteria 1
Contact, 4kV	Performance Criteria 2	(A1, A2, A3, A4, A5)	
Electrical surge immunity	EN/IEC 61000-4-5	Signal : 1kV, 5kHz	Performance Criteria 1
Output, line to line, 1kV	Performance Criteria 2	(Us, 11, 12, 14)	
Output, line to earth, 2kV	Performance Criteria 2	Radiated radio frequency immunity	EN/IEC 61000-4-3
RGC..AA..	Performance Criteria 1	10V/m, 80 - 1000MHz	Performance Criteria 1
A1, A2, line to line, 500V	Performance Criteria 1	10V/m, 1.4 - 2.0GHz	Performance Criteria 1
A1, A2, line to earth, 500V	Performance Criteria 1	3V/m, 2.0 - 2.7GHz	Performance Criteria 1
RGC..I.., RGC..V..		Conducted radio frequency immunity	EN/IEC 61000-4-6
A1, A2, A3, A4, A5		10V/m, 0.15 - 80MHz	Performance Criteria 1
Line to earth, 1kV	Performance Criteria 2	Voltage dips	EN/IEC 61000-4-11
Us+, Us-	Performance Criteria 2	0% for 0.5, 1cycle	Performance Criteria 2
Line to line, 500V	Performance Criteria 2	40% for 10 cycles	Performance Criteria 2
Line to earth, 500V	Performance Criteria 2	70% for 25 cycles	Performance Criteria 2
Us ~, 11, 12, 14	Performance Criteria 2	80% for 250 cycles	Performance Criteria 2
Line to line, 1kV	Performance Criteria 2	Voltage interruptions immunity	EN/IEC 61000-4-11
Line to earth, 2kV	Performance Criteria 2	0% for 5000ms	Performance Criteria 2
EMC emission	EN 60947-4-3	Radio interference field emission (radiated)	EN/IEC 55011
Radio interference voltage emission (conducted)	EN/IEC 55011	30-1000MHz	Class A (Industrial)
0.15-30MHz	Class A (with external filtering)		

Note:

- Control input lines must be installed together to maintain products susceptibility to Radio Frequency Interference.
- Use of AC solid state relays may according to the application and the load current, cause conducted radio interferences. Use of mains filters may be necessary for cases where the user must meet E.M.C requirements. The capacitor values given inside the filtering specification tables should be taken only as indications, the filter attenuation will depend on the final application.
- This product has been designed for Class A equipment. (External filtering may be required, refer to filtering section). Use of this product in domestic environments may cause radio interference, in which case the user may be required to employ additional mitigation methods.
- Surge tests on RGC..A models were carried out with the signal line impedance network. In case the line impedance is less than 40Ω, it is suggested that AC supply is provided through a secondary circuit where the short circuit limit between conductors and ground is 1500VA or less.
- A deviation of one step in the distributed full cycle models and up to 1.5% Full Scale Deviation in phase angle models is considered to be within PC1 criteria.

- Performance Criteria 1 (Performance Criteria A): No degradation of performance or loss of function is allowed when the product is operated as intended.

- Performance Criteria 2 (Performance Criteria B): During the test, degradation of performance or partial loss of function is allowed. However, when the test is complete the product should return operating as intended by itself.

- Performance Criteria 3 (Performance Criteria C): Temporary loss of function is allowed, provided the function can be restored by manual operation of the control.

Filtering - EN/IEC 55011 Compliance

Part no.	Compliance to Class A emission limits		Compliance to Class B emission limits	
	Max. load current	Suggested filter	Max. load current	Suggested filter
RGC2P..C1..	25AAC	2.2uF, max. 760VAC / X1	25AAC	Epcos, B84143A0025R105 / 530VAC
	40AAC	2.2uF, max. 760VAC / X1	40AAC	Epcos, B84143A0050R105 / 530VAC
RGC2P..C4..	25AAC	1.0uF, max. 760VAC / X1	25AAC	Epcos, B84143A0025R105 / 530VAC
	40AAC	1.0uF, max. 760VAC / X1	40AAC	Epcos, B84143A0050R105 / 530VAC
RGC3P..E..	20AAC	Epcos, B84143A0025R105 / 530VAC	13AAC	Epcos, B84143A0025R105 / 530VAC
	30AAC	Epcos, B84143D0050R127 / 530VAC	-	-
RGC3P..C1..	20AAC	2.2uF, max. 760VAC / X1	20AAC	Epcos, B84143A0025R105 / 530VAC
	30AAC	2.2uF, max. 760VAC / X1	30AAC	Epcos, B84143A0050R105 / 530VAC
RGC3P..C4..	20AAC	1.0uF, max. 760VAC / X1	20AAC	Epcos, B84143A0025R105 / 530VAC
	30AAC	1.0uF, max. 760VAC / X1	30AAC	Epcos, B84143A0050R105 / 530VAC
RGC3P..C16..	20AAC	1.0uF, max. 760VAC / X1	20AAC	Epcos, B84143A0025R105 / 530VAC
	30AAC	1.0uF, max. 760VAC / X1	30AAC	Epcos, B84143A0050R105 / 530VAC
RGC3P..S..	20AAC	1.0uF, max. 760VAC / X1	20AAC	Epcos, B84143A0025R105 / 530VAC
	30AAC	1.0uF, max. 760VAC / X1	30AAC	Epcos, B84143A0050R105 / 530VAC

Filter Connection Diagrams

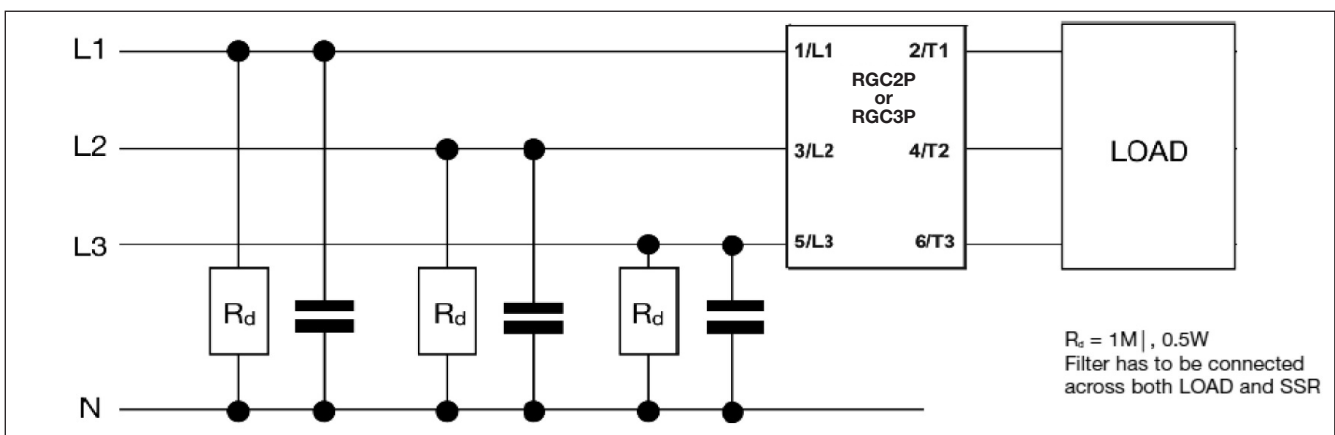
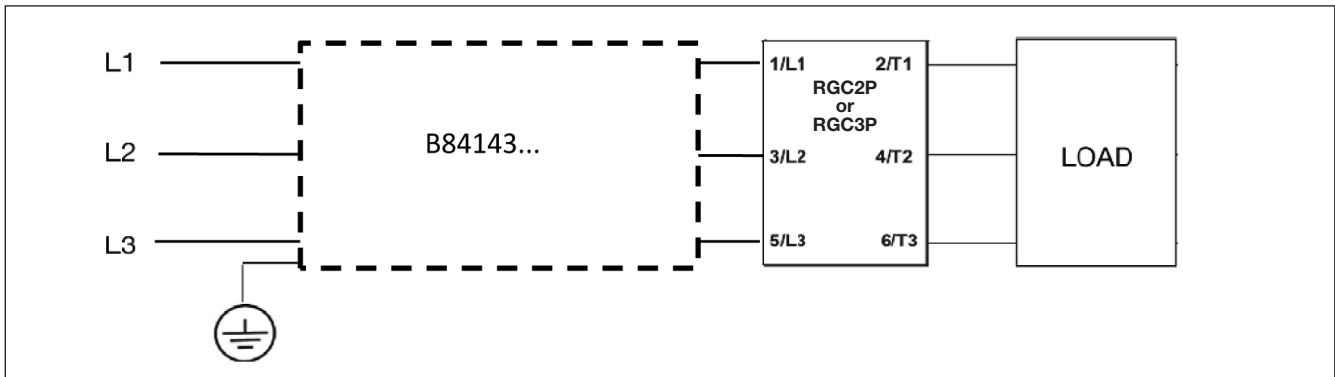

Note: The suggested filtering is determined by tests carried out on a representative setup and load. The RGC2P., RGC3P. is intended to be integrated within a system where conditions may differentiate from conditions utilised for tests, such as load, cable lengths and other auxiliary components that may exist within the end system. It shall be the responsibility of the system integrator to ensure that the system containing the above component complies with the applicable rules and regulations.

Epcos installation recommendations shall be taken in consideration when utilising such filters.

Terminals Layout

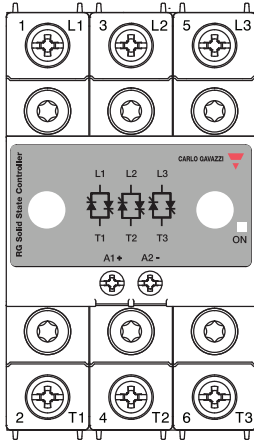

RGC2P..AA15, RGC2P..AA25, RGC2P..AA40
RGC3P..AA20, RGC3P..AA30

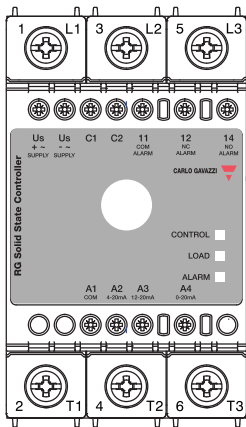

RGC2P..I25, RGC2P..I40
RGC3P..I20, RGC3P..I30

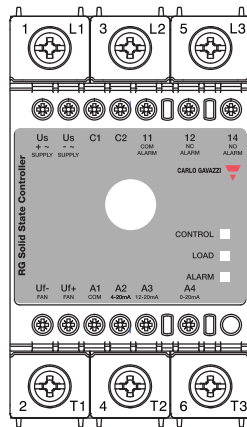

RGC2P..I75
RGC3P..I65

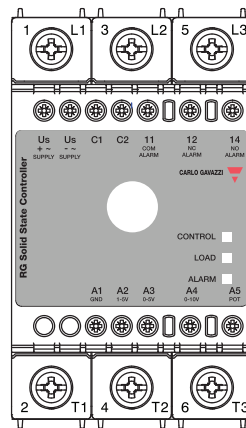

RGC2P..V25, RGC2P..V40
RGC3P..V20, RGC3P..V30

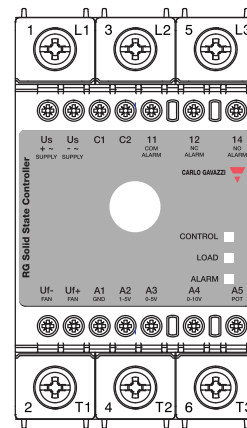

RGC2P..V75
RGC3P..V65

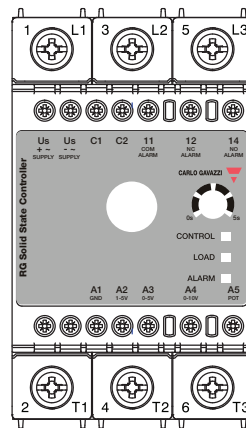

RGC3P..V20S.., RGC3P..V30S..

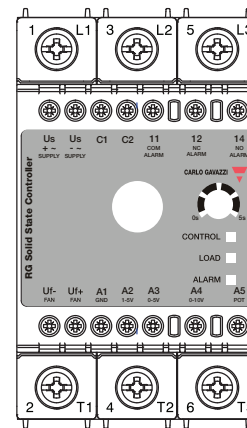

RGC3P..V65S..

Terminals Labelling:

- 1/L1, 2/L2, 3/L3: Line connections
- 2/T1, 4/T2, 6/T3: Load connections
- A1, A2: Control input
4-20mA (RGC..AA..), 4-20mA (RGC..I..), 1-5V (RGC..V..)
- A1, A3: Control input,
12-20mA (RGC..I..), 0-5V (RGC..V..)
- A1, A4: Control input
0-20mA (RGC..I..), 0-10V (RGC..V..)
- A5: External Potentiometer input (RGC..V..)
- Us (+, -): External supply, positive signal (RGC..DM, DFM, DP, DFP),
AC signal (RGC..AM, AFM, AP, AFP)
- Us (-, ~): External supply, ground (RGC..DM, DFM, DP, DFP),
AC signal (RGC..AM, AFM, AP, AFP)
- C1, C2: Configuration mode selection
External short link between C1 & C2 is required ONLY in case of 4-wire, 3-phase systems
- Uf+: Fan supply positive signal
- Uf -: Fan supply ground

Connections to Uf-, Uf+ are readily terminated by manufacturer. No other connection is required by end user.

Dimensions

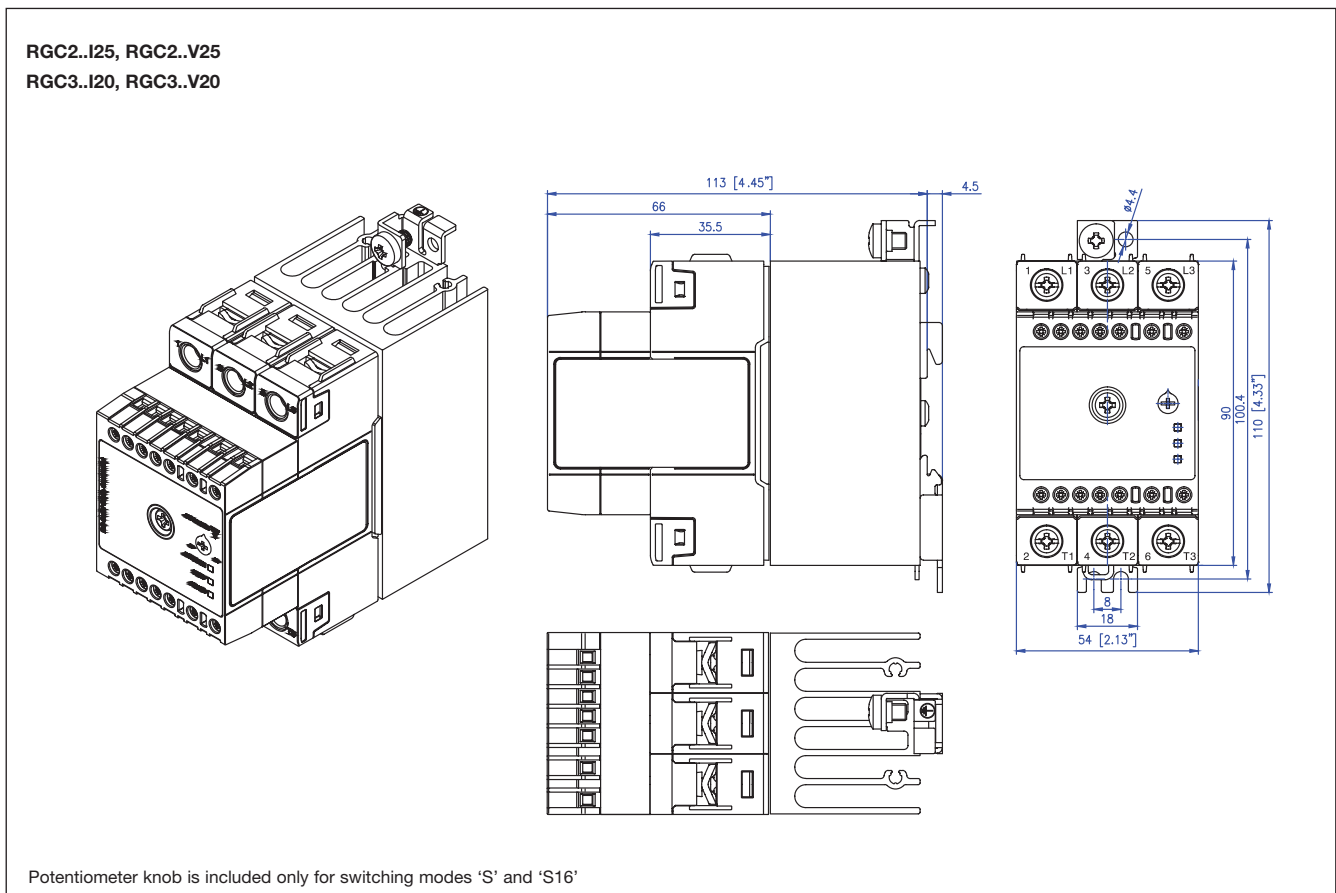
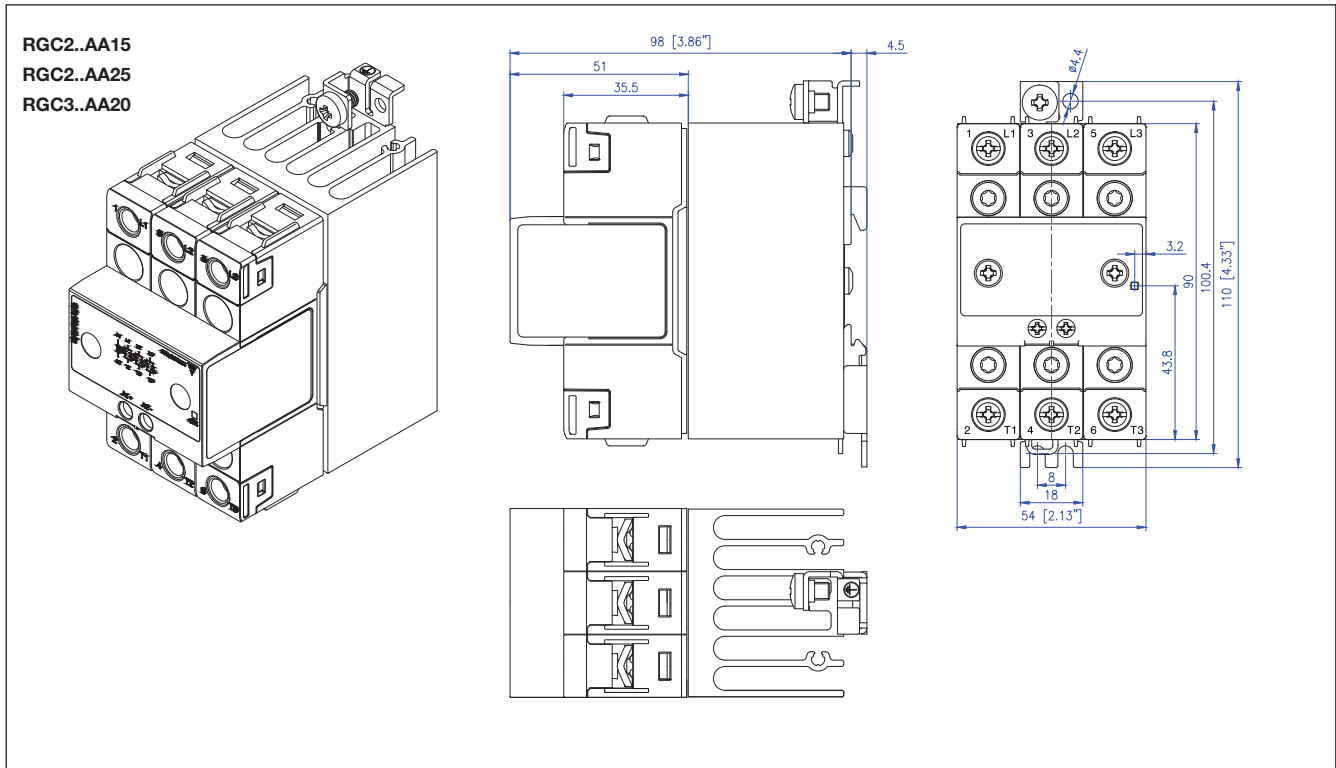

Dimensions in mm. Housing width tolerance +0.5mm, - 0mm as per DIN43880.
All other tolerances ±0.5mm

Dimensions

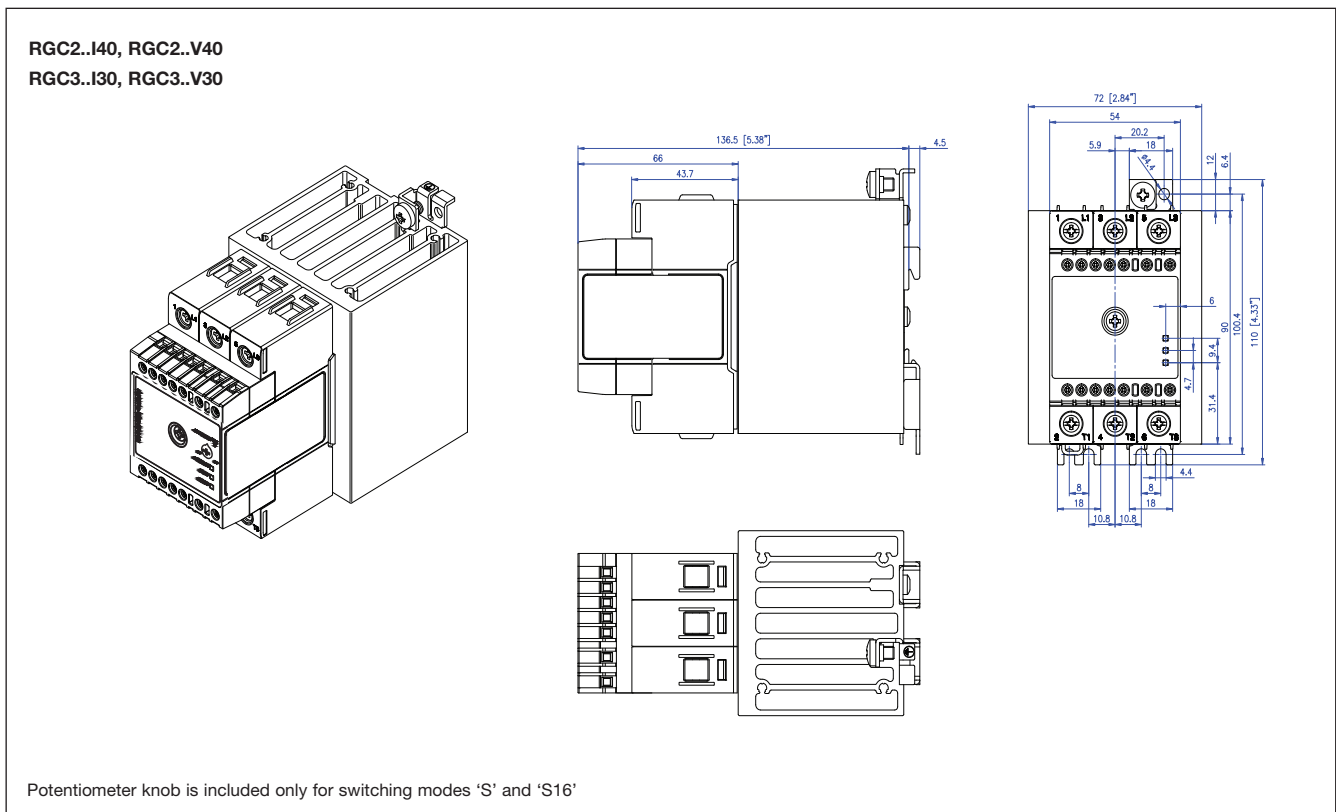
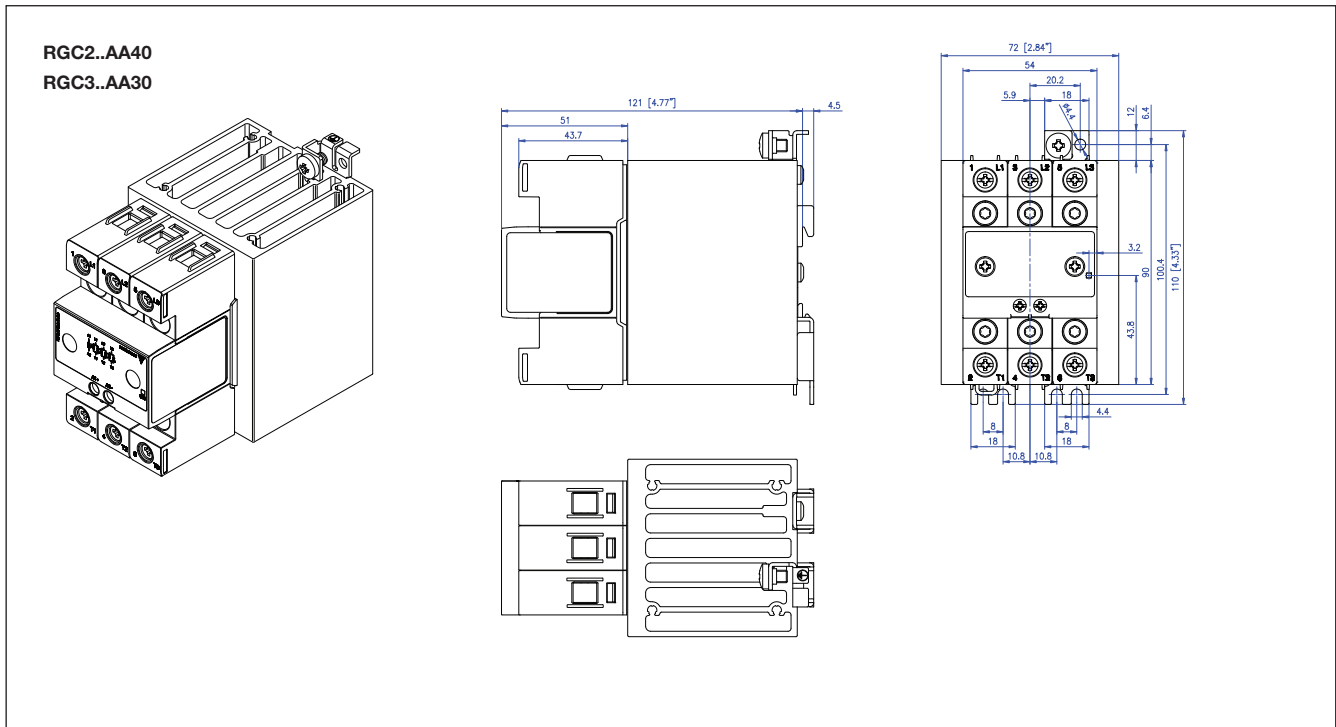





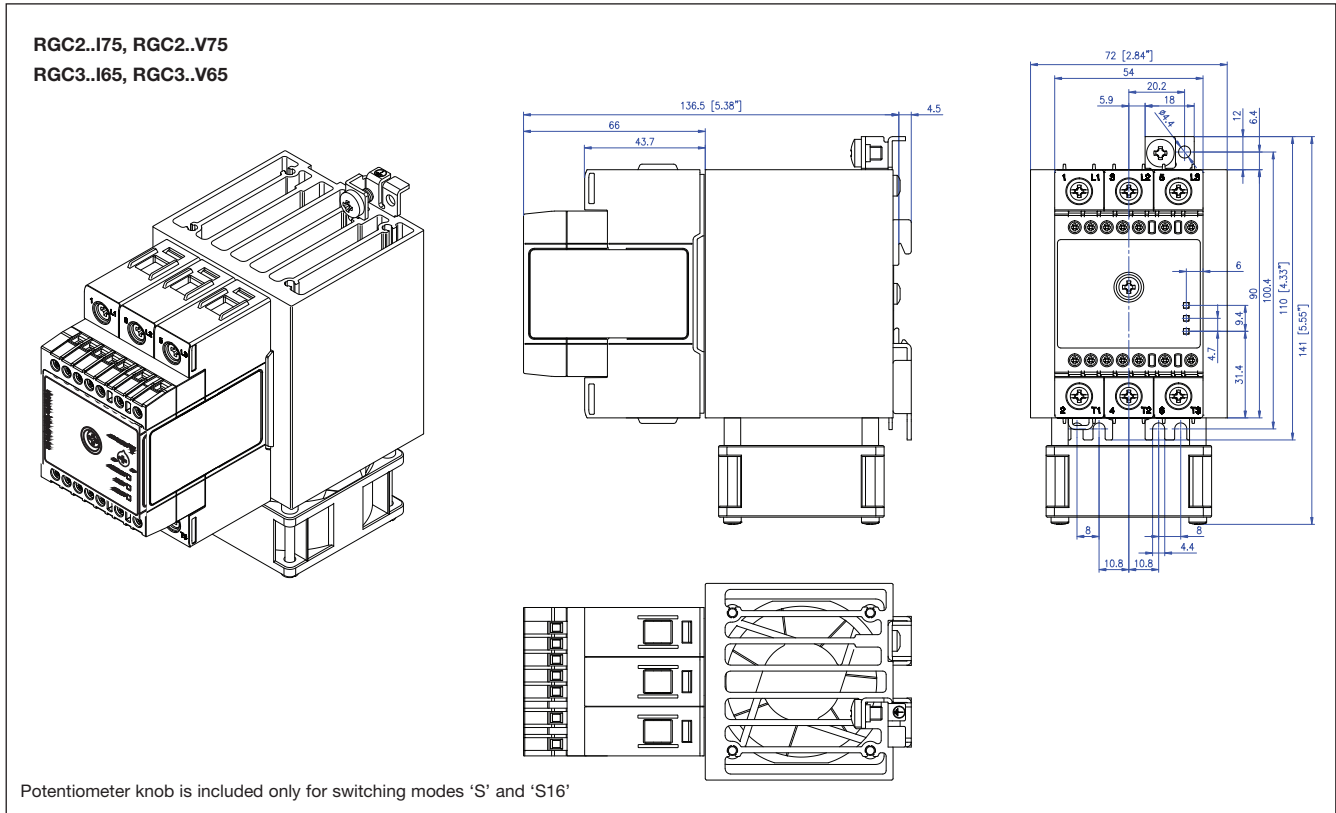





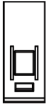
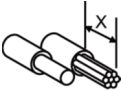

Dimensions in mm. Housing width tolerance +0.5mm, -0mm as per DIN43880.
All other tolerances ±0.5mm

Dimensions

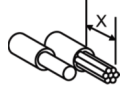

Dimensions in mm. Housing width tolerance +0.5mm, -0mm as per DIN43880.
All other tolerances ±0.5mm

Connection Specifications

POWER CONNECTIONS		1/L1, 3/L2, 5/L3, 2/T1, 4/T2, 6/T3		
Use 75°C copper (Cu) conductors		RGC2..15, RGC2..25 RGC3..20		RGC2..40, RGC2..75 RGC3..30, RGC3..65
				
Stripping length (X)		12mm		11mm
Connection type		M4 screw with captivated washer		M5 screw with box clamp
Rigid (solid & stranded) UL/cUL rated data		2x 2.5 - 6.0 mm ² 2x 14 - 10 AWG	1x 2.5 - 6.0 mm ² 1x 14 - 10 AWG	1x 2.5 - 25 mm ² 1x 14 - 3 AWG
Flexible with end sleeve		2x 1.0 - 2.5 mm ² 2x 2.5 - 4.0 mm ² 2x 18 - 14 AWG 2x 14 - 12 AWG	1x 1.0 - 4.0 mm ² 1x 18 - 12 AWG	1x 2.5 - 16 mm ² 1x 14 - 6 AWG
Flexible without end sleeve		2x 1.0 - 2.5 mm ² 2x 2.5 - 6.0 mm ² 2x 18 - 14 AWG 2x 14 - 10 AWG	1x 1.0 - 6.0 mm ² 1x 18 - 10 AWG	1x 4.0 - 25 mm ² 1x 12 - 3 AWG
Torque specification		Pozidriv 2 UL: 2Nm (17.7 lb-in) IEC: 1.5-2.0Nm (13.3-17.7 lb-in)		Pozidriv 2 UL: 2.5Nm (22 lb-in) IEC: 2.5-3.0Nm (22-26.6 lb-in)
Aperture for termination lug		12.3mm		n/a
Protective Earth (PE) connection		M5, 1.5Nm (13.3 lb-in) Not provided with SSR. PE connection required when product is intended to be used in Class 1 applications according to EN/IEC 61140		
CONTROL CONNECTIONS		A1, A2		A1, A2, A3, A4, A5 Us, Uf, 11, 12, 14, C1, C2
Use 75°C copper (Cu) conductors		RGC..AA..		RGC..I.., RGC..V..
				
Stripping length (X)		8mm		8 mm
Connection type		M3 screw with captivated washer		M3 screw with box clamp
Rigid (solid & stranded) UL/cUL rated data		2x 0.5 - 2.5 mm ² 2x 18 - 12 AWG	1x 0.5 - 2.5 mm ² 1x 18 - 12 AWG	1x 1.0 - 2.5 mm ² 1x 18 - 12 AWG
Flexible with end sleeve		2x 0.5 - 2.5 mm ² 2x 18 - 12 AWG	1x 0.5 - 2.5 mm ² 1x 18 - 12 AWG	1x 0.5 - 2.5 mm ² 1x 20 - 12 AWG
Torque specification		Pozidriv 1 UL: 0.5Nm (4.4 lb-in) IEC: 0.5-0.6Nm (4.4-5.3 lb-in)		Pozidriv 1 UL: 0.5Nm (4.4 lb-in) IEC: 0.4-0.5Nm (3.5-4.4 lb-in)

Connection Diagram

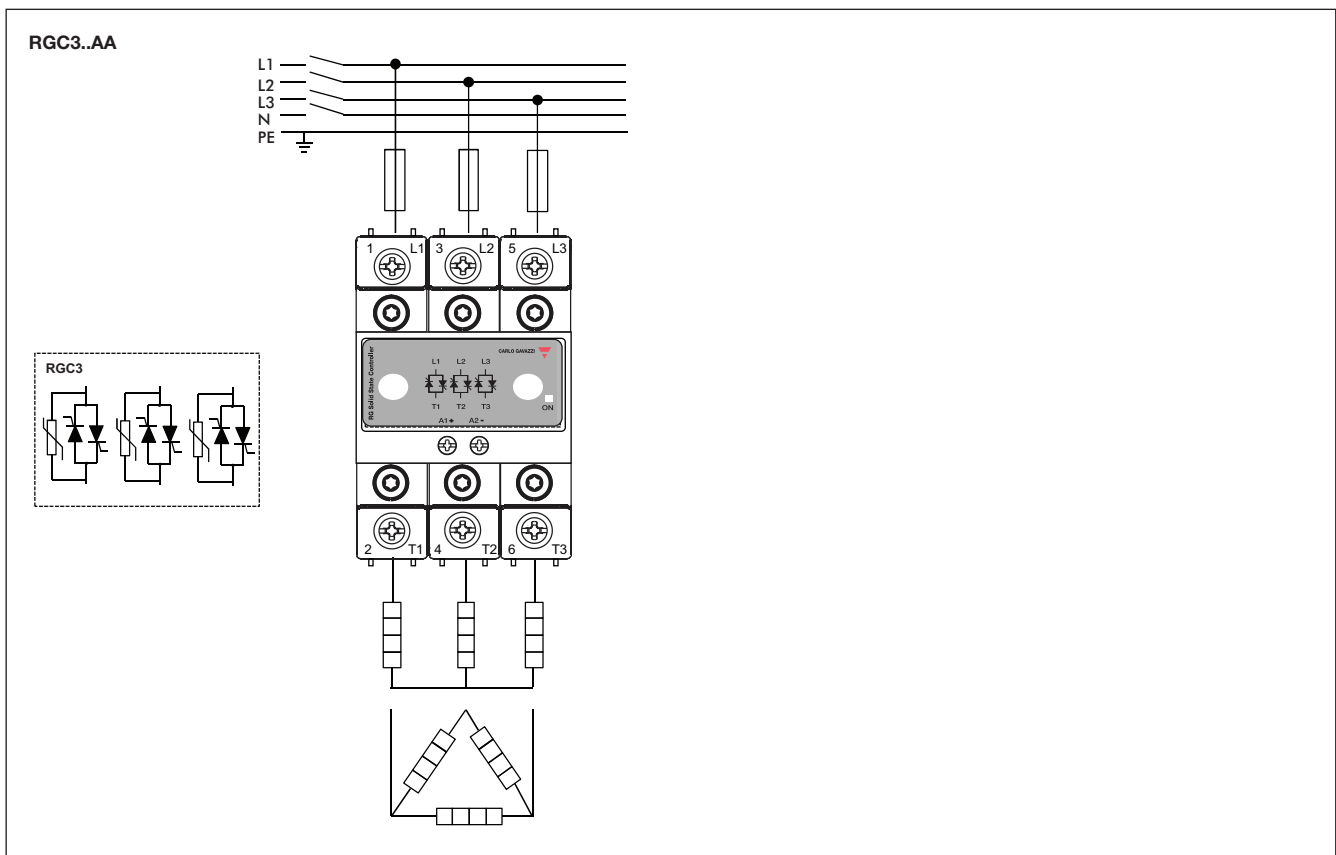
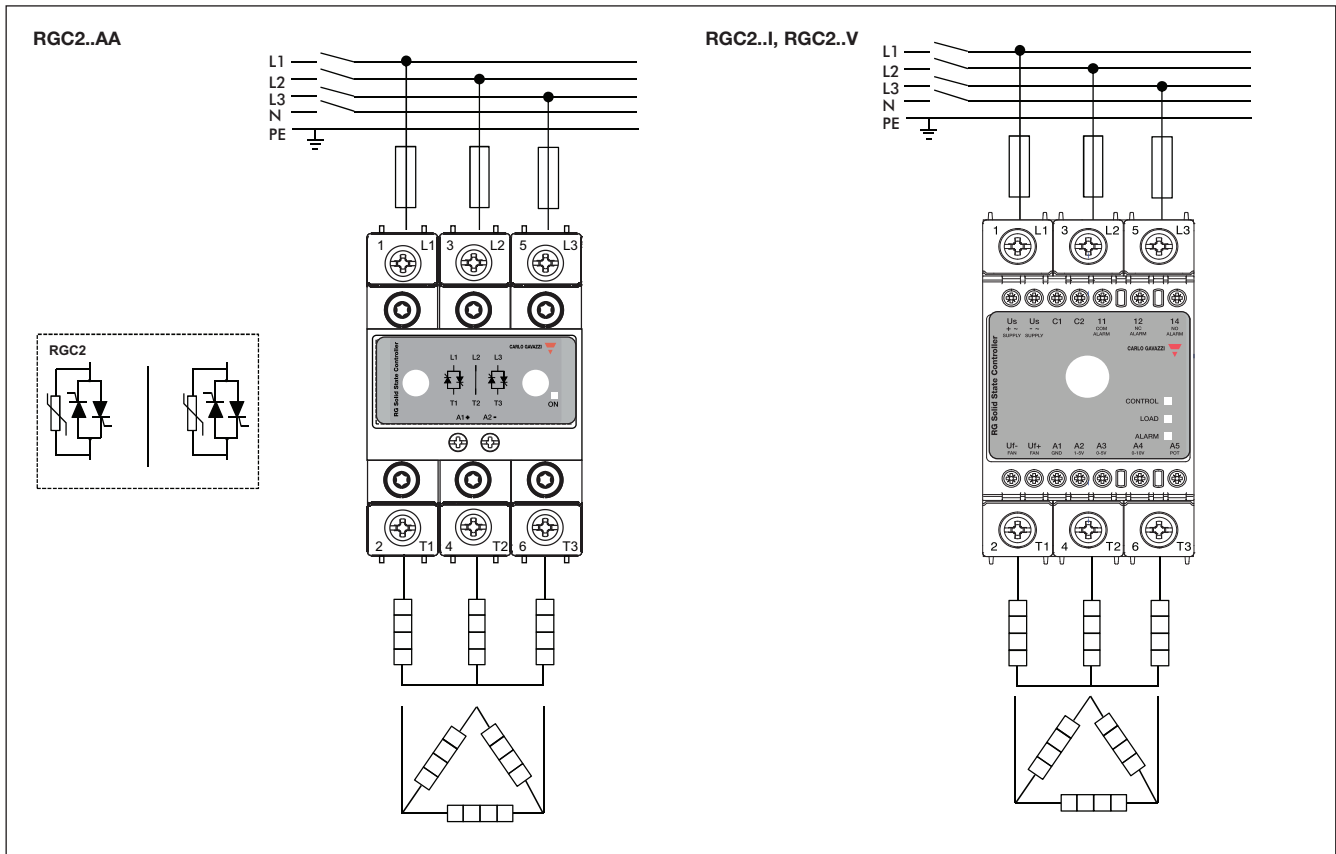

Connection Diagram

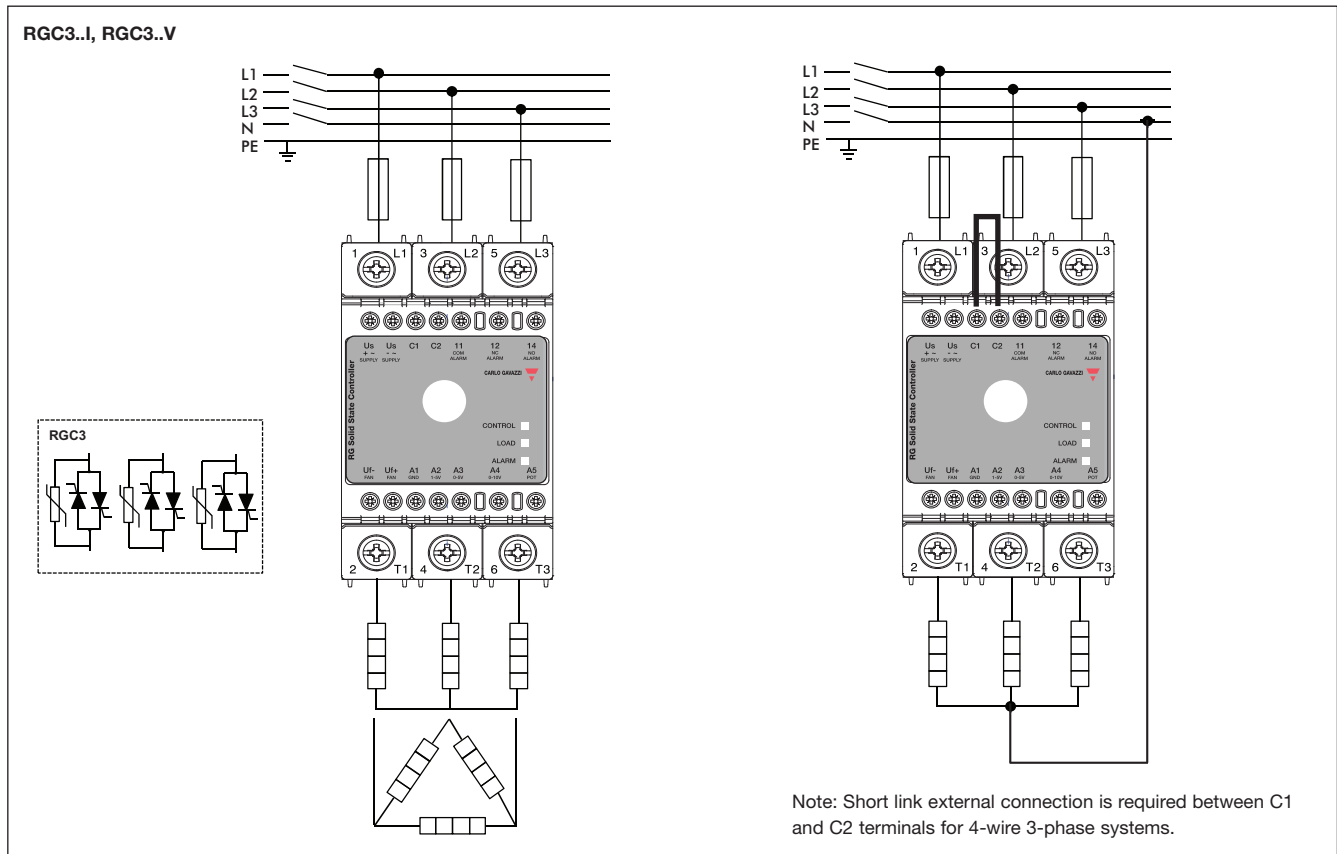

Connection Configuration

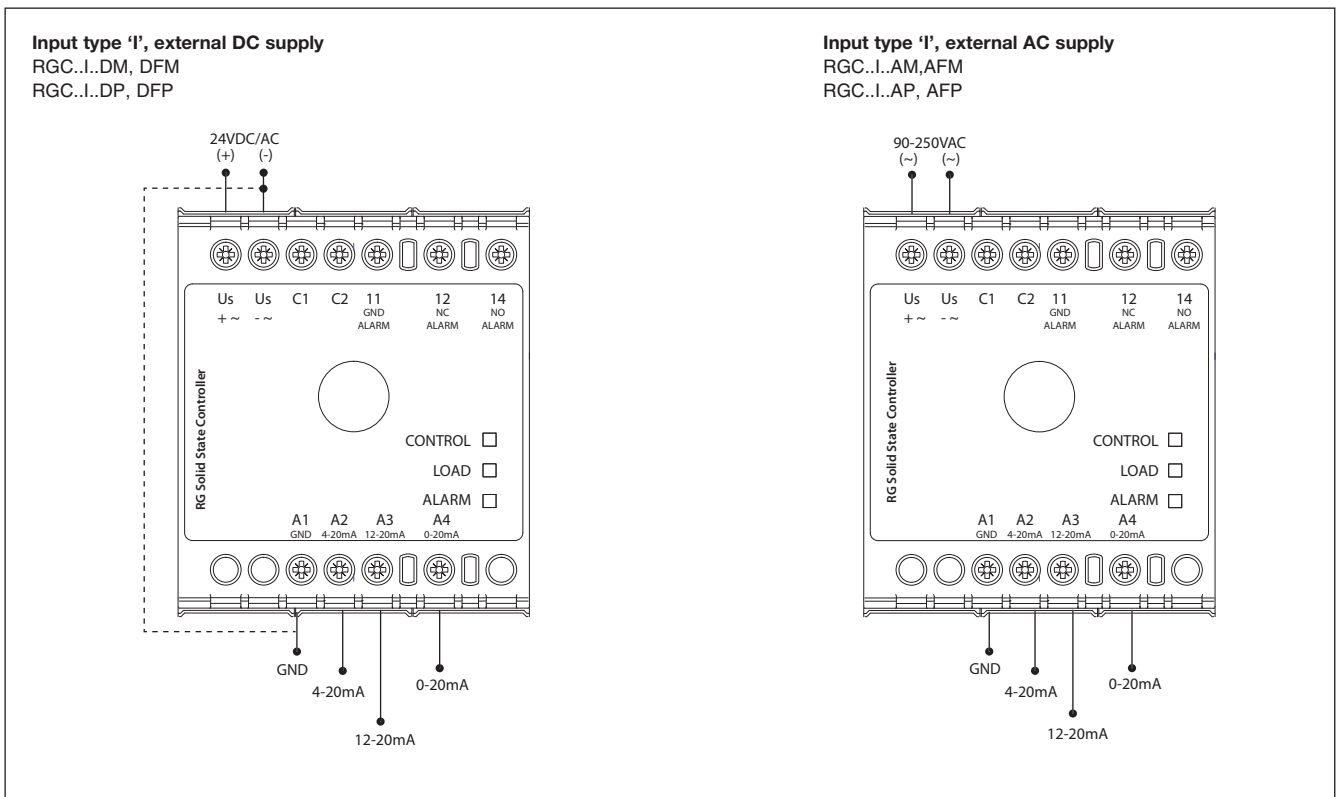

Note: Control input shall be connected either to A1-A2 or A1-A3 or A1-A4 only

Connection Configuration

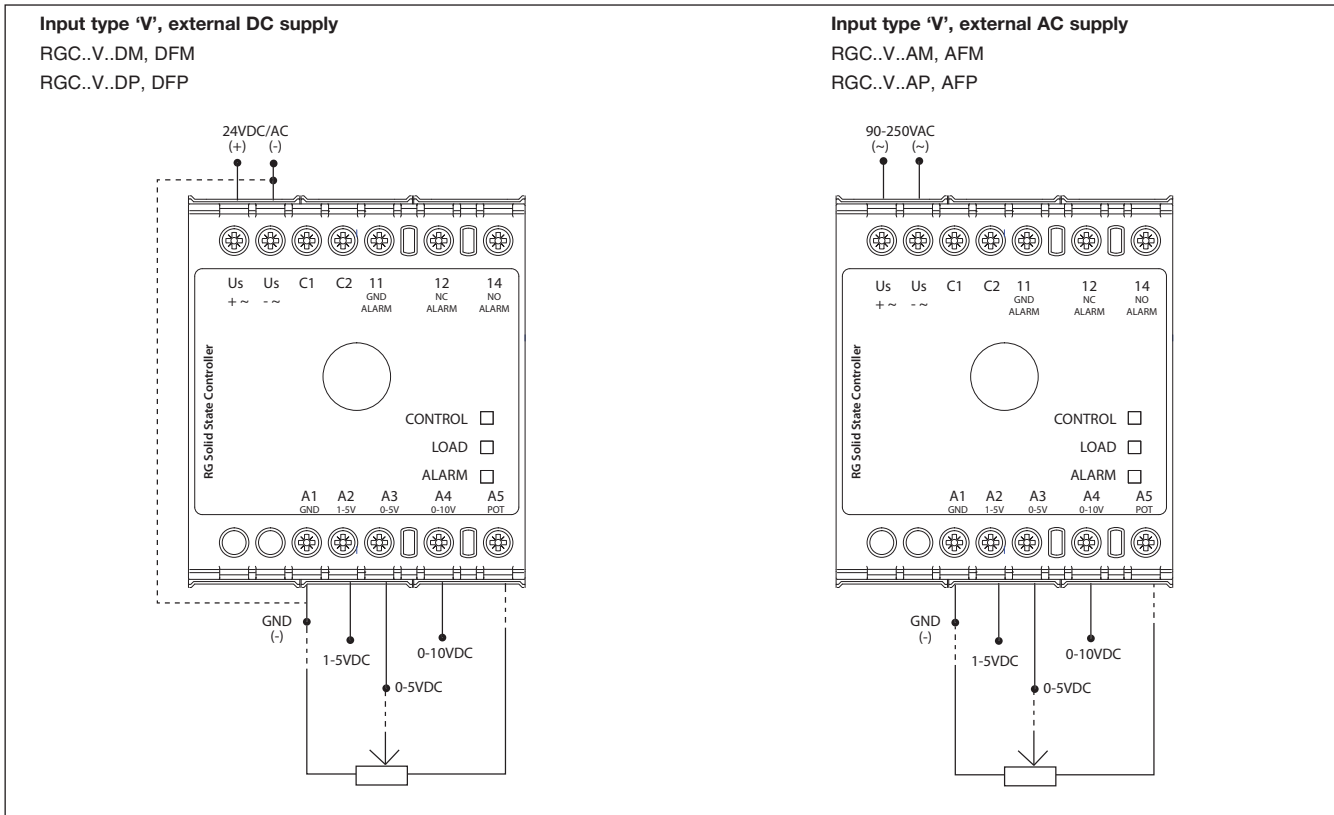

Note: Control input shall be connected either to A1-A2 or A1-A3 or A1-A4 or A1-A3-A5 in case an external potentiometer is used.

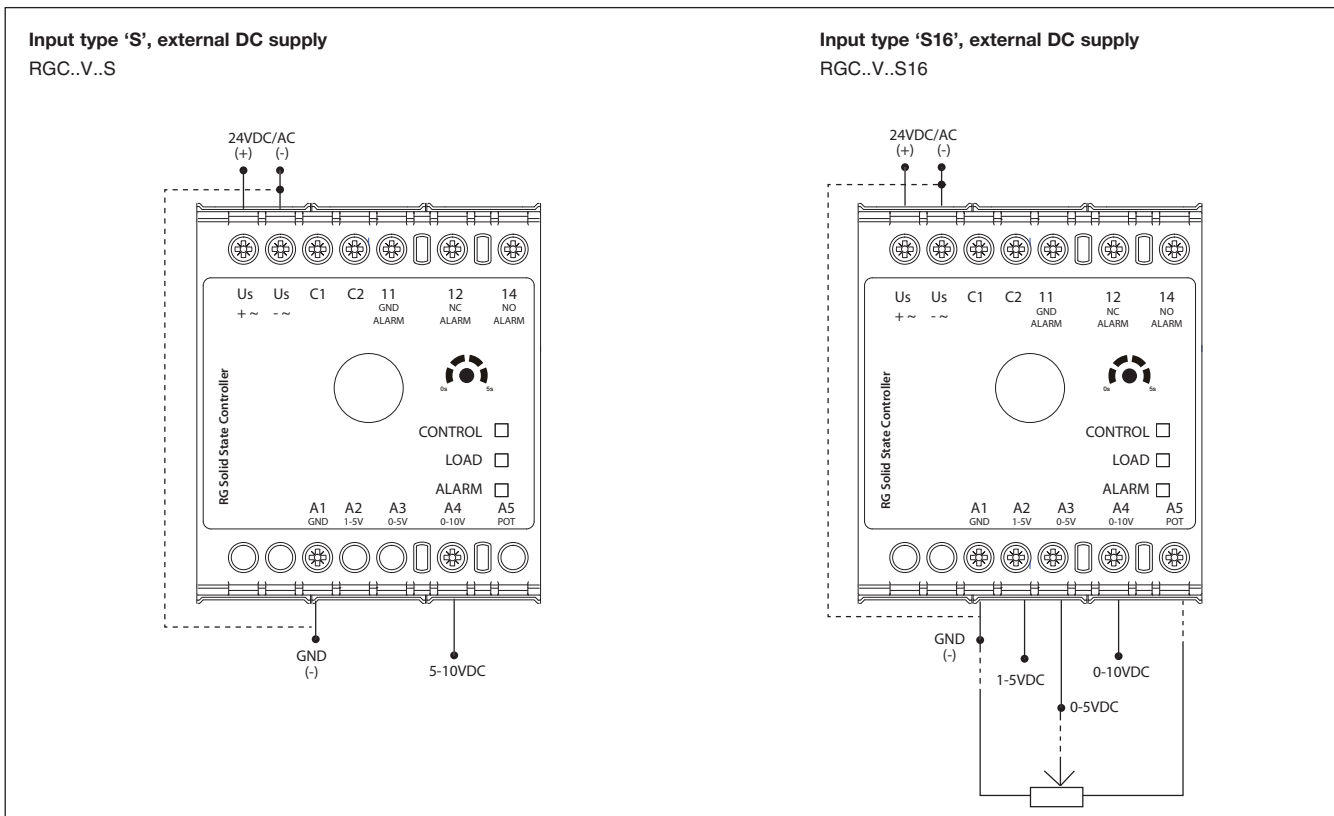

Note: Control input shall be connected to terminals A1-A4 in the case of the RGC3P..S.. In the case of the RGC3P..S16.., the control input shall be connected to either A1-A2 or A1-A3 or A1-A4 or A1-A3-A5 in case an external potentiometer is used.

Mode of Operation

RGC..AA...

The diagram below, Operation Diagram 1, indicates the behaviour of models having input type 'AA' in different operating conditions. The models with this type of input are able to detect abnormal conditions such as **Mains Loss** and **SSR Internal Fault**. The presence of these abnormal conditions is indicated through the green LED which in normal operating conditions is associated with status of the control input. A flashing sequence of this LED is utilised to distinguish such abnormal conditions. Refer to LED Indications section for further details.

Operation Diagram 1:

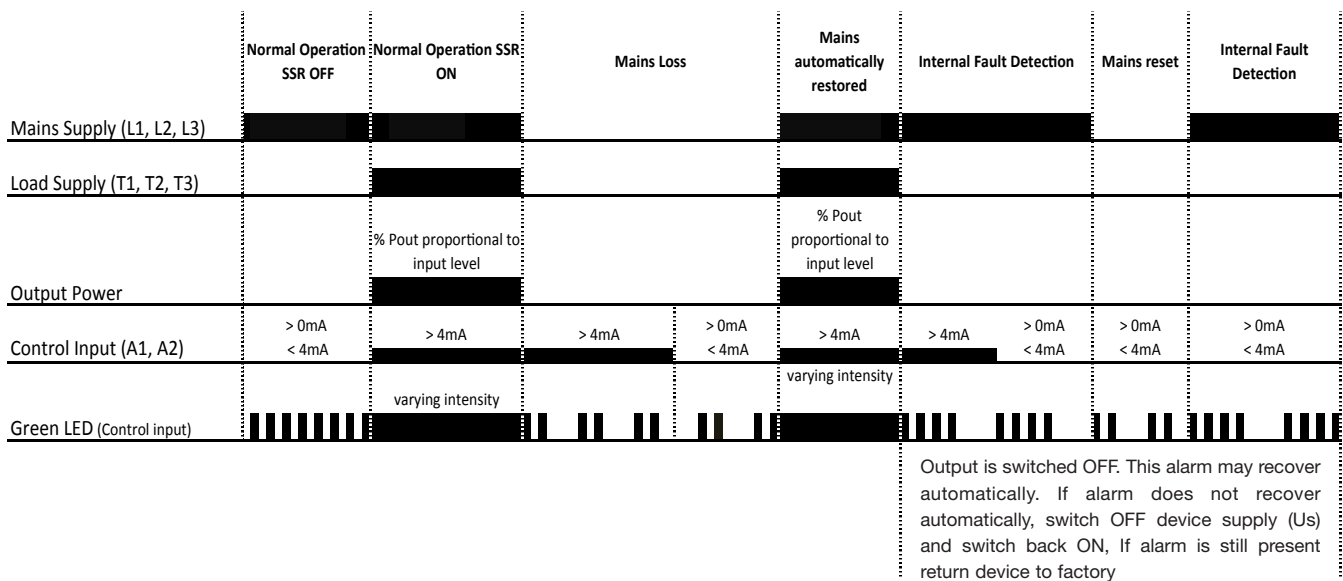

RGC..I, RGC..V.

The versions with input type 'I' or 'V' have integrated system monitoring for the detection of system and also SSR faults. An external supply of 24VDC/AC or 90-250VAC, selectable through part no. configuration, is required for the operation of these models.

In case of a fault condition, an alarm signal is issued through an EMR. A red LED is also used for visual indication with a specific flash rate for easy identification of the alarm type. Refer to section LED Indications for further details. Additionally, a yellow LED is present on the models with 'I' or 'V' input type which gives an indication of the status of the load. This LED is ON every time the SSR output, and hence the load, is in the ON state.

System monitoring is identified with suffix 'P' or 'M' at the end of the RGC part no. The following is a description of the difference between the two suffixes.

Note: Monitoring for system and SSR faults is not active during the soft start function available with models RGC3P60V..S.. and RGC3P60V..S16.

Mode of Operation

1. RGC..I..P, RGC..V..P

The versions with suffix 'P' are available only with switching mode 'E', i.e., phase angle. The detectable alarm conditions in this series are the following:

- Mains Loss (Operation Diagram 2)
- SSR Over Temperature (Operation Diagram 3)
- SSR Internal Fault (Operation Diagram 3)

The following operation diagrams show the behaviour of the RGC..I..P and RGC..V..P under different operating and abnormal conditions.

Operation Diagram 2:

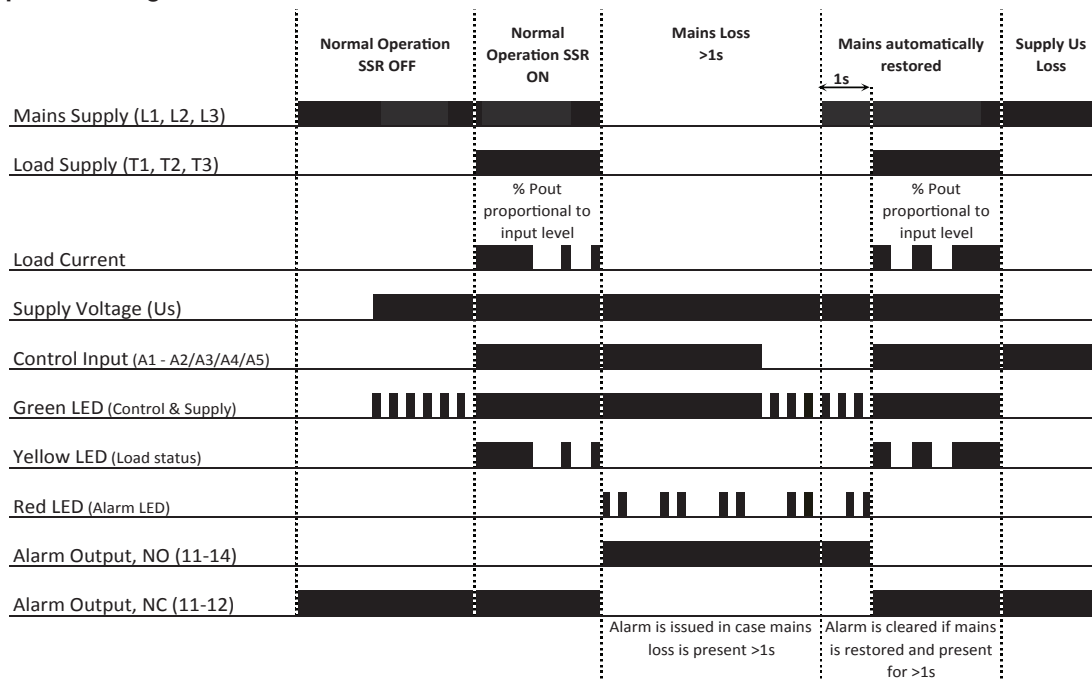

Operation Diagram 3:

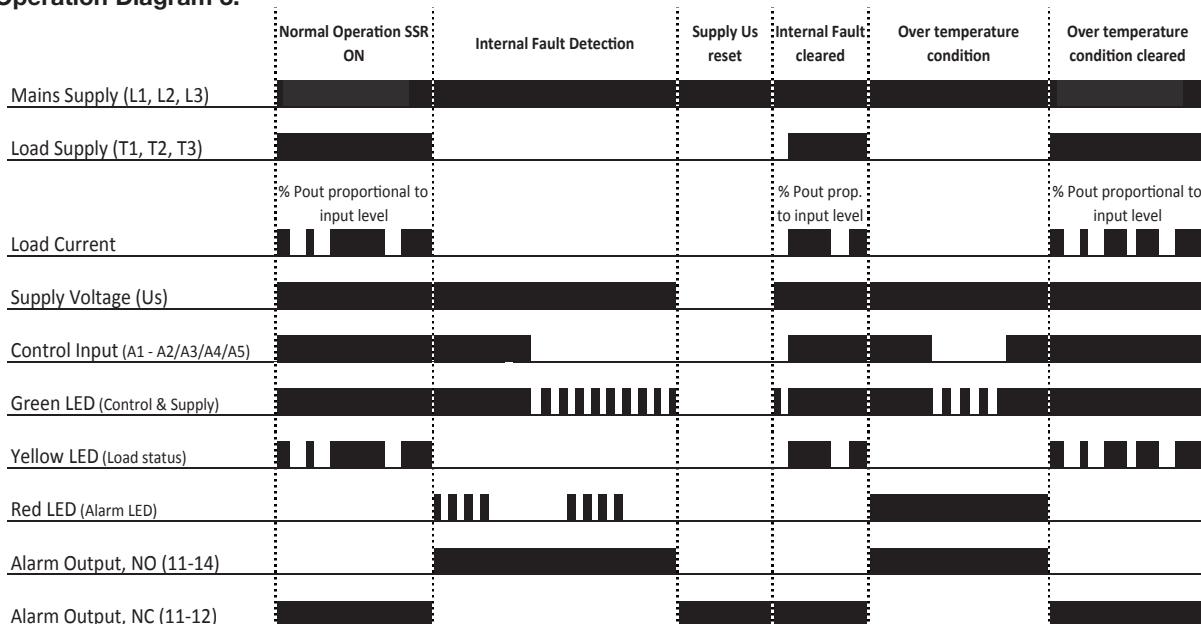

Mode of Operation

2. RGC..I..M, RGC..V..M

Suffix 'M' is available with all switching modes apart from mode 'E'. The detectable alarm conditions for the versions with suffix 'M' are the following:

- Mains Loss (Operation Diagram 2)
- SSR Over Temperature (Operation Diagram 3)
- SSR Internal Fault (Operation Diagram 3)
- Load Loss (Operation Diagram 4)
- SSR Open Circuit (Operation Diagram 4)
- SSR Short Circuit (Operation Diagram 5)

The operation diagrams for Mains Loss, SSR Over Temperature and SSR Internal Fault for the RGC..I..M and RGC..V..M are identical to those of RGC..I..P and RGC..V..P shown in Operation Diagrams 2 and 3. The following diagrams show the behaviour of the RGC..I..M and RGC..V..M under the additional detectable abnormal conditions available only with the 'M' suffix versions.

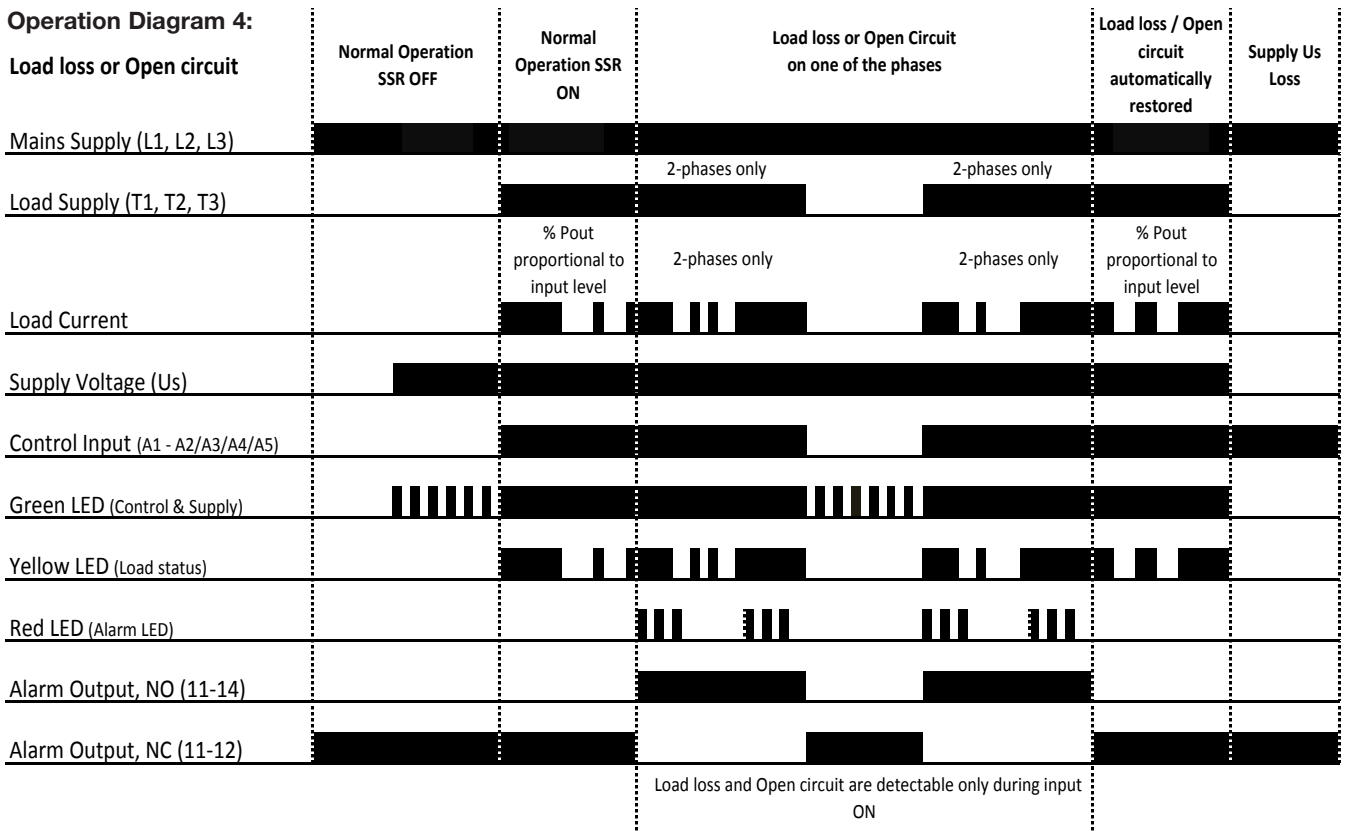

Mode of Operation

Operation diagram 5

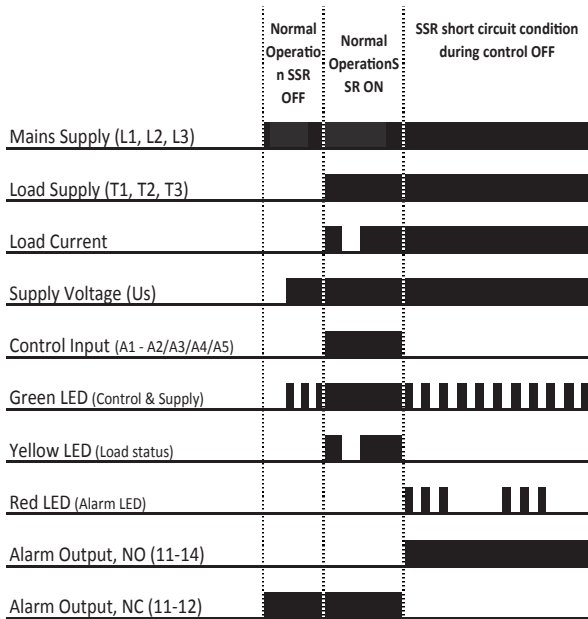



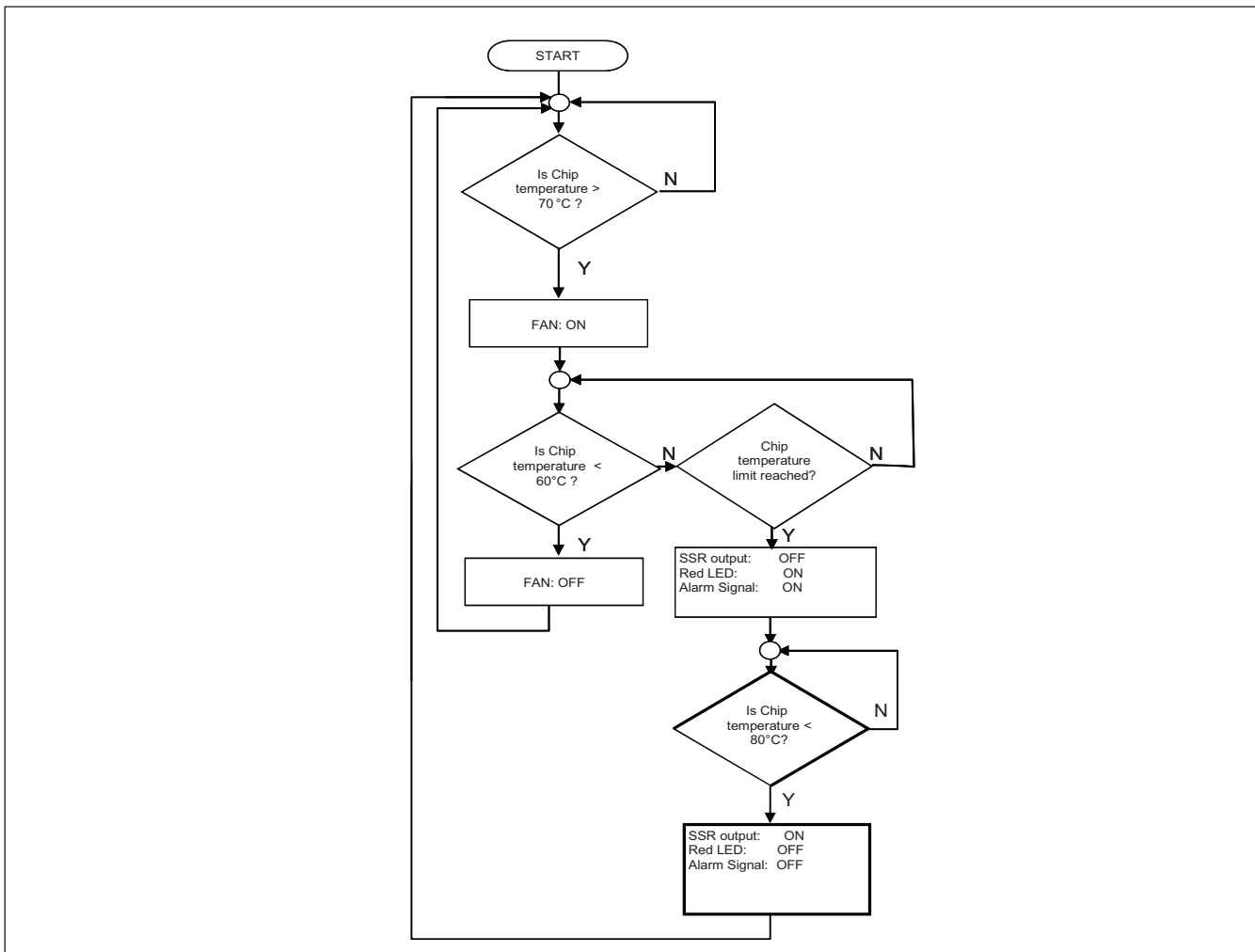



Fan operation for RGC..F..





LED Indications

Green LED

	RGC..AA..	RGC..I., RGC..V..
Control ON RGC..AA: <4mA flash rate 0.5s ON, 0.5s OFF RGC..I, RGC..V: ON in presence on control input		
Control ON RGC..AA: >4mA, varying intensity with input level		
Internal error: RGC..AA: 4 flashes 0.5s ON, 0.5s OFF with 3s OFF interval RGC..I, RGC..V: not applicable; refer to red LED		
Mains Loss RGC..AA: 2 flashes 0.5s ON, 0.5s OFF with 3s OFF interval RGC..I, RGC..V: not applicable; refer to red LED		
Supply ON: (no control input) RGC..AA: not applicable RGC..I, RGC..V: flash rate 0.5s ON, 0.5s OFF		

In case of an internal error, attempt to reset the Mains supply by Switching OFF and back ON to clear the error condition. If this condition is still present, return device to factory.

Red LED

Flashes	Red LED	Timing Diagram
2	Mains Loss	
3	Monitoring alarm: Load loss, SSR open circuit, SSR short circuit	
4	SSR internal fault	
100%	SSR over temperature	

Installation Instructions

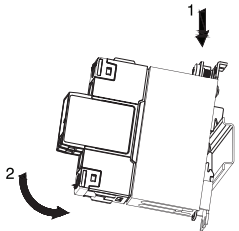

1 ↓
2 ↻

Mounting on DIN rail

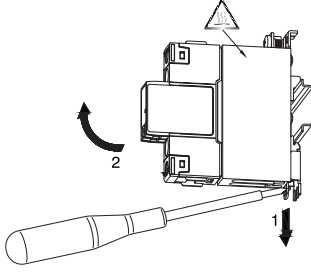

2 ↻
1 ↓

Dismounting from DIN rail

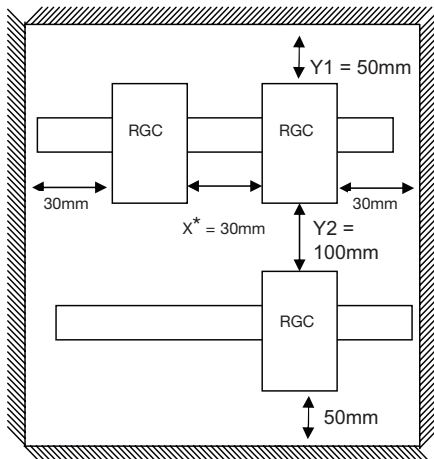

Y1 = 50mm
Y2 = 100mm
X* = 30mm
30mm

* Refer to Current Derating curves at 0mm for 0mm spacing between units

Short Circuit Protection

Protection Co-ordination, Type 1 vs Type 2:

Type 1 protection implies that after a short circuit, the device under test will no longer be in a functioning state. In type 2 co-ordination the device under test will still be functional after the short circuit. In both cases, however the short circuit has to be interrupted. The fuse between enclosure and supply shall not open. The door or cover of the enclosure shall not be blown open. There shall be no damage to conductors or terminals and the conductors shall not separate from terminals. There shall be no breakage or cracking of insulating bases to the extent that the integrity of the mounting of live parts is impaired. Discharge of parts or any risk of fire shall not occur.

The product variants listed in the table hereunder are suitable for use on a circuit capable of delivering not more than 100,000A Symmetrical Amperes, 600Volts maximum when protected by fuses. Tests at 100,000Arms were performed with Class J fuses, fast acting; please refer to the tables below for maximum ratings. Tests with Class J fuses are representative of Class CC fuses.

Co-ordination type 1 (UL508)

Part No.	Max. fuse size [A]	Class	Short circuit current [kArms]	Voltage [VAC]
RGC2..15 RGC2..25	30	J or CC	100	Max. 600
RGC2..40	40	J	100	Max. 600
RGC2..75	60 ⁶	J	100	Max. 600
RGC3..20	30	J or CC	100	Max. 600
RGC3..30	40	J	100	Max. 600
RGC3..65	60 ⁶	J	100	Max. 600

6: Consult a Carlo Gavazzi sales representative for use of 70A class J fuses

Co-ordination type 2 (EN/IEC 60947-4-3)

Part No.	Ferraz Shawmut (Mersen)		Siba		Short circuit current [kArms]	Voltage [VAC]
	Max. fuse size [A]	Part number	Max. fuse size [A]	Part Number		
RGC2..15 RGC2..25	40	660 URC 14x51/40	32	50 142 06 32	10	600
	40	6.9xx gRC URD 22x58/40			100	
	40	660 URD 22x58/40				
	40	A70QS40-4				
RGC2..40	63	6.9xx gRC URC 14x51/63	63	50 194 20 63	10	600
	63	6.9xx gRC URD 22x58/63			100	
	60	A70QS60-4				
RGC2..75	100	6.9xx gRC URD 22x58/100	125	50 196 20 125	10	600
	100	660 URQ 27x60/100			100	
	100	A70QS100-4				
RGC3..20	32	6.9xx gRC URC 14x51/32	32	50 142 06 32	10	600
	32	6.9xx gRC URC 14x51/32			100	
	40	A70QS40-4				
RGC3..30	40	6.9xx gRC URC 14x51/40	40	50 194 20 40	10	600
	40	6.9xx gRC URC 14x51/40			100	
	40	A70QS40-4				
RGC3..65	100	6.9xx gRC URC 22x58/100	125	50 196 20 125	10	600
	90	660 URD 22x58/90			100	
	100	A70QS100-4				

Type 2 Protection Coordination with Miniature Circuit Breakers (M.C.Bs)

Solid State Relay type	ABB Model no. for Z - type M. C. B. (rated current)	ABB Model no. for B - type M. C. B. (rated current)	Wire cross sectional area [mm ²]	Minimum length of Cu wire conductor [m] ⁷
RGC2..15 RGC2..25 RGC3..20 (1,800 A ² s)	S201 - Z10 (10A)	S201 - B4 (4A)	1.0	7.6
			1.5	11.4
			2.5	19.0
	S201 - Z16 (16A)	S201 - B6 (6A)	1.0	5.2
			1.5	7.8
			2.5	13.0
			4.0	20.8
	S201 - Z20 (20A)	S201 - B10 (10A)	1.5	12.6
			2.5	21.0
	S201 - Z25 (25A)	S201 - B13 (13A)	2.5	25.0
4.0			40.0	
RGC2..40 RGC3..30 (6,600 A ² s)	S201 - Z20 (20A)	S201 - B10 (10A)	1.5	4.2
			2.5	7.0
			4.0	11.2
	S201 - Z32 (32A)	S201 - B16 (16A)	2.5	13
			4.0	20.8
			6.0	31.2
RGC2..75 RGC3..65 (15,000 A ² s)	S201 - Z25 (25A)	S201 - B16 (16A)	2.5	3.1
			4.0	5.0
			6.0	7.5
	S201 - Z50 (50A)	S201 - B25 (25A)	4.0	8.0
			6.0	12.0
			10.0	20.0
			16.0	32.0
	S201 - Z63 (63A)	S201 - B32 (32A)	6.0	11.3
			10.0	18.8
			16.0	30.0

7: Between MCB and Load (including return path which goes back to the mains if applicable)

Note: A prospective current of 6kArms and a 230/400V power supply system is assumed for the above suggested specifications. For cables with different cross section than those mentioned above please consult Carlo Gavazzi's Technical Support Group.

Accessories

Fan



Ordering Key

RGC3FAN60

Fan accessory
for RGC2..75 and RGC3..65

Environmental Information

The declaration in this section is prepared in compliance with People's Republic of China Electronic Industry Standard SJ/T11364-2014: Marking for the Restricted Use of Hazardous Substances in Electronic and Electrical Products.

Part Name	Toxic or Harardous Substances and Elements					
	Lead (Pb)	Mercury (Hg)	Cadmium (Cd)	Hexavalent Chromium (Cr(VI))	Polybrominated biphenyls (PBB)	Polybrominated diphenyl ethers (PBDE)
Power Unit Assembly	x	○	○	○	○	○
<p>O: Indicates that said hazardous substance contained in homogeneous materials for this part are below the limit requirement of GB/T 26572.</p> <p>X: Indicates that said hazardous substance contained in one of the homogeneous materials used for this part is above the limit requirement of GB/T 26572.</p>						

环境特性

这份申明根据中华人民共和国电子工业标准 SJ/T11364-2014：标注在电子电气产品中限定使用的有害物质

零件名称	有毒或有害物质与元素					
	铅 (Pb)	汞 (Hg)	镉 (Cd)	六价铬 (Cr(VI))	多溴化联苯 (PBB)	多溴联苯醚 (PBDE)
功率单元	x	○	○	○	○	○
<p>O: 此零件所有材料中含有的该有害物低于GB/T 26572的限定。</p> <p>X: 此零件某种材料中含有的该有害物高于GB/T 26572的限定。</p>						

