

**UltraCMOS® RF Digital Step Attenuator, 7-bit, 31.75 dB with Optional V<sub>SS\_EXT</sub> Bypass Mode 9 kHz - 8 GHz**

**Features**

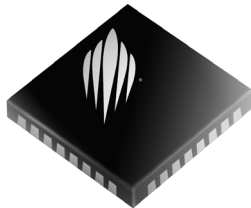
- HaRP™ technology enhanced
- Safe attenuation state transitions
- Attenuation options: covers a 31.75 dB range in 0.25 dB, 0.5 dB, or 1.0 dB steps
  - 0.25 dB monotonicity for ≤ 6 GHz
  - 0.50 dB monotonicity for ≤ 7 GHz
  - 1.00 dB monotonicity for ≤ 8 GHz
- High power handling @ 8 GHz in 50Ω
  - 28 dBm CW
  - 31 dBm instantaneous power
- High linearity
  - IIP3 of 61 dBm
- 1.8V/3.3V control logic
- Programming modes
  - Direct parallel
  - Latched parallel
  - Serial
  - Serial Addressable
- High-attenuation state @ power-up (PUP)
- ESD performance
  - 1.5kV HBM on all pins

**Product Description**

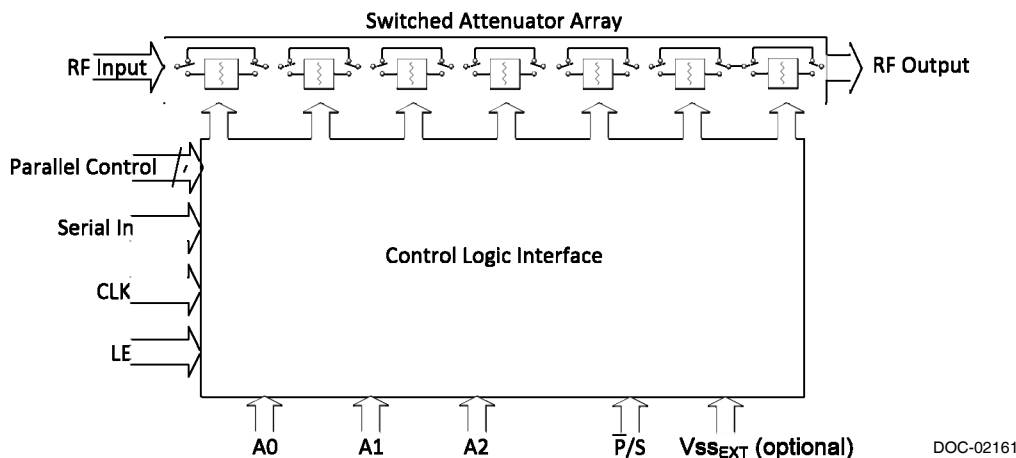
The PE43704 is a HaRP™ technology-enhanced, high linearity, 7-bit 50Ω RF digital step attenuator (DSA). It offers maximum power handling of 28 dBm up to 8 GHz and covers a 31.75 dB attenuation range in 0.25 dB, 0.5 dB, or 1.0 dB steps. The PE43704 is a pin-compatible version of PE43703. It provides multiple CMOS control interfaces and an optional V<sub>SS\_EXT</sub> bypass mode to improve spurious performance. It maintains high attenuation accuracy over frequency and temperature and exhibits very low insertion loss and low power consumption. No blocking capacitors are required if DC voltage is not present on the RF ports.

The PE43704 is manufactured on pSemi's UltraCMOS® process, a patented variation of silicon-on-insulator (SOI) technology on a sapphire substrate, offering the performance of GaAs with the economy and integration of conventional CMOS.

**Figure 1. Package Type**  
32-lead 5x5 QFN



**Figure 2. Functional Diagram**



DOC-02161

**Table 1. Electrical Specifications: 0.25 dB steps @ +25°C,  $V_{DD} = 2.3V$  to  $5.5V$ ,  $V_{SS_{EXT}} = 0V$  or  $V_{DD} = 3.4V$  to  $5.5V$ ,  $V_{SS_{EXT}} = -3.4V$  ( $Z_S = Z_L = 50\Omega$ ) unless otherwise noted**

| Parameter                                | Condition                                   | Frequency      | Min   | Typ       | Max   | Unit     |  |
|--|---|----------------|-------|-----------|---|----------|--|
| Operating frequency                      |   |                | 9 kHz |           | 6000 MHz  | As shown |  |
| Attenuation range                        | 0.25 dB Step                                |                |       | 0 – 31.75 |   | dB       |  |
| Insertion loss                           |   | 9 kHz – 2 GHz  |       | 1.3       | 1.6   | dB       |  |
|  |   | 2 GHz – 4 GHz  |       | 1.7       | 2.0   | dB       |  |
|  |   | 4 GHz – 6 GHz  |       | 2.4       | 2.8   | dB       |  |
| Attenuation error                        | 0 dB – 15.75 dB Attenuation settings        | 9 KHz ≤ 4 GHz  |       |           | + (0.15 + 4.5% of Attenuation Setting)<br>- (0.1 + 2% of Attenuation Setting)   | dB       |  |
|  |   |                |       |           | + (0.15 + 6% of Attenuation Setting)<br>- (0.15+1% of Attenuation Setting)      | dB       |  |
|  | 16 dB – 31.75 dB Attenuation settings       | 9 KHz ≤ 4 GHz  |       |           | + (0.15 + 4.5% of Attenuation Setting)<br>- (0.1 + 2.5% of Attenuation Setting) | dB       |  |
|  |   |                |       |           | + (0.25 + 6.5% of Attenuation Setting)<br>- (0.2+1% of Attenuation Setting)     | dB       |  |
|  |   | 4 GHz – 6 GHz  |       |           |   |          |  |
|  |   |                |       |           |   |          |  |
| Return loss                              | Input port                                  | 9 kHz – 4 GHz  |       | 20        |   | dB       |  |
|  |   | 4 GHz – 6 GHz  |       | 15        |   | dB       |  |
| Return loss                              | Output port                                 | 9 kHz – 4 GHz  |       | 17        |   | dB       |  |
|  |   | 4 GHz – 6 GHz  |       | 13        |   | dB       |  |
| Relative phase                           | 0 dB – 31.75 dB Attenuation settings        | 9 kHz – 6 GHz  |       | 58        |   | deg      |  |
| Input 1dB compression point <sup>1</sup> |   | 50 MHz – 6 GHz | 32    | 34        |   | dBm      |  |
| IIP3                                     | Two tones at +18 dBm, 20 MHz spacing        | 50 MHz – 6 GHz |       | 61        |   | dBm      |  |
| Typical spurious value <sup>2</sup>      | $V_{SS_{EXT}} = 0V$                         |                |       | -140      |   | dBm      |  |
| RF Trise/Tfall                           | 10% / 90% RF                                |                |       | 600       |   | ns       |  |
| Settling time                            | RF settled to within 0.05 dB of final value |                |       | 2         |   | μs       |  |
| Switching time                           | 50% CTRL to 90% or 10% RF                   |                |       | 1.1       |   | μs       |  |

Notes: 1. The input 1dB compression point is a linearity figure of merit. Refer to Table 5 for the RF input power  $P_{IN}$  (50Ω)  
 2. To prevent negative voltage generator spurs, supply -3.4 volts to  $V_{SS_{EXT}}$

**Table 2. Electrical Specifications: 0.5 dB steps @ +25°C,  $V_{DD} = 2.3V$  to  $5.5V$ ,  $V_{SS_{EXT}} = 0V$  or  $V_{DD} = 3.4V$  to  $5.5V$ ,  $V_{SS_{EXT}} = -3.4V$  ( $Z_S = Z_L = 50\Omega$ ) unless otherwise noted**

| Parameter                                | Condition                                   | Frequency      | Min           | Typ      | Max  | Unit     |    |
|--|---|----------------|---------------|----------|--|----------|----|
| Operating frequency                      |   |                | 9 kHz         |          | 7000 MHz   | As shown |    |
| Attenuation range                        | 0.5 dB Step                                 |                |               | 0 – 31.5 |  | dB       |    |
| Insertion loss                           |   | 9 kHz – 2 GHz  |               | 1.3      | 1.6  | dB       |    |
|  |   | 2 GHz – 4 GHz  |               | 1.7      | 2.0  | dB       |    |
|  |   | 4 GHz – 6 GHz  |               | 2.4      | 2.8  | dB       |    |
|  |   | 6 GHz – 7 GHz  |               | 2.5      | 2.9  | dB       |    |
| Attenuation error                        | 0 dB – 15.5 dB Attenuation settings         | 9 KHz ≤ 4 GHz  |               |          | + (0.15 + 4.5% of Attenuation Setting)<br>- (0.1 + 2% of Attenuation Setting)    | dB       |    |
|  |   |                |               |          | + (0.25 + 5.5% of Attenuation Setting)<br>- (0.15 + 1% of Attenuation Setting)   | dB       |    |
|  | 16 dB – 31.5 dB Attenuation settings        | 9 KHz ≤ 4 GHz  |               |          | + (0.15 + 4.5% of Attenuation Setting)<br>- (0.1 + 2.5% of Attenuation Setting)  | dB       |    |
|  |   |                |               |          | + (0.25 + 6.5% of Attenuation Setting)<br>- (0.25 + 2.5% of Attenuation Setting) | dB       |    |
|  | Return loss                                 | Input port     | 9 kHz – 4 GHz |          | 20   |          | dB |
|  |   |                | 4 GHz – 7 GHz |          | 16   |          | dB |
| Return loss                              | Output port                                 | 9 kHz – 4 GHz  |               | 17       |  | dB       |    |
|  |   | 4 GHz – 7 GHz  |               | 14       |  | dB       |    |
| Relative phase                           | 0 dB – 31.5 dB Attenuation settings         | 9 kHz – 7 GHz  |               | 65       |  | deg      |    |
| Input 1dB compression point <sup>1</sup> |   | 50 MHz – 7 GHz | 32            | 34       |  | dBm      |    |
| IIP3                                     | Two tones at +18 dBm, 20 MHz spacing        | 50 MHz – 7 GHz |               | 61       |  | dBm      |    |
| Typical spurious value <sup>2</sup>      | $V_{SS_{EXT}} = 0V$                         |                |               | -140     |  | dBm      |    |
| RF Trise/Tfall                           | 10% / 90% RF                                |                |               | 600      |  | ns       |    |
| Settling time                            | RF settled to within 0.05 dB of final value |                |               | 2        |  | μs       |    |
| Switching time                           | 50% CTRL to 90% or 10% RF                   |                |               | 1.1      |  | μs       |    |

Notes: 1. The input 1dB compression point is a linearity figure of merit. Refer to Table 5 for the RF input power  $P_{IN}$  (50Ω)  
2. To prevent negative voltage generator spurs, supply -3.4 volts to  $V_{SS_{EXT}}$

**Table 3. Electrical Specifications: 1 dB steps @ +25°C, V<sub>DD</sub> = 2.3V to 5.5V, V<sub>SS</sub>EXT = 0V or V<sub>DD</sub> = 3.4V to 5.5V, V<sub>SS</sub>EXT = -3.4V (Z<sub>S</sub> = Z<sub>L</sub> = 50Ω) unless otherwise noted**

| Parameter                                | Condition                                   | Frequency      | Min   | Typ    | Max   | Unit     |
|--|---|----------------|-------|--------|---|----------|
| Operating frequency                      |   |                | 9 kHz |        | 8000 MHz  | As shown |
| Attenuation range                        | 1 dB Step                                   |                |       | 0 - 31 |   | dB       |
| Insertion loss                           |   | 9 kHz – 2 GHz  |       | 1.3    | 1.6   | dB       |
|  |   | 2 GHz – 4 GHz  |       | 1.7    | 2.0   | dB       |
|  |   | 4 GHz – 6 GHz  |       | 2.4    | 2.8   | dB       |
|  |   | 6 GHz – 8 GHz  |       | 2.9    | 3.2   | dB       |
| Attenuation error                        | 0 dB – 15 dB Attenuation settings           | 9 kHz ≤ 4 GHz  |       |        | + (0.15 + 4.5% of Attenuation Setting)<br>- (0.1 + 2% of Attenuation Setting)   | dB<br>dB |
|  |   | 4 GHz ≤ 7 GHz  |       |        | + (0.25 + 6% of Attenuation Setting)<br>- (0.25 + 2% of Attenuation Setting)    | dB<br>dB |
|  |   | 7 GHz – 8 GHz  |       |        | + (0.25 + 7% of Attenuation Setting)<br>- (0.25 + 2% of Attenuation Setting)    | dB<br>dB |
|  | 16dB – 31 dB Attenuation settings           | 9 kHz ≤ 4 GHz  |       |        | + (0.15 + 4.5% of Attenuation Setting)<br>- (0.1 + 2.5% of Attenuation Setting) | dB<br>dB |
|  |   | 4 GHz ≤ 7 GHz  |       |        | + (0.25 + 6.5% of Attenuation Setting)<br>- (0.25 + 3% of Attenuation Setting)  | dB<br>dB |
|  |   | 7 GHz – 8 GHz  |       |        | + (0.25 + 7% of Attenuation Setting)<br>- (0.25 + 4% of Attenuation Setting)    | dB<br>dB |
| Return loss                              | Input port                                  | 9 kHz – 4 GHz  |       | 20     |   | dB       |
|  |   | 4 GHz – 8 GHz  |       | 14.5   |   | dB       |
| Return loss                              | Output port                                 | 9 kHz – 4 GHz  |       | 17     |   | dB       |
|  |   | 4 GHz – 8 GHz  |       | 12.5   |   | dB       |
| Relative phase                           | 0 dB – 31 dB Attenuation settings           | 9 kHz – 8 GHz  |       | 80     |   | deg      |
| Input 1dB compression point <sup>1</sup> |   | 50 MHz – 8 GHz | 32    | 34     |   | dBm      |
| IIP3                                     | Two tones at +18 dBm, 20 MHz spacing        | 50 MHz – 8 GHz |       | 61     |   | dBm      |
| Typical spurious value <sup>2</sup>      | V <sub>SS</sub> EXT = 0V                    |                |       | -140   |   | dBm      |
| RF Trise/Tfall                           | 10% / 90% RF                                |                |       | 600    |   | ns       |
| Settling time                            | RF settled to within 0.05 dB of final value |                |       | 2      |   | μs       |
| Switching time                           | 50% CTRL to 90% or 10% RF                   |                |       | 1.1    |   | μs       |

Notes: 1. The input 1dB compression point is a linearity figure of merit. Refer to Table 5 for the RF input power P<sub>IN</sub> (50Ω)  
2. To prevent negative voltage generator spurs, supply -3.4 volts to V<sub>SS</sub>EXT

Figure 3. Pin Configuration (Top View)

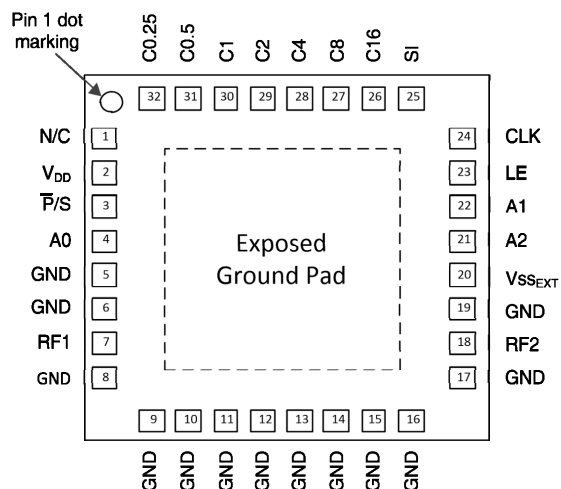


Table 4. Pin Descriptions

| Pin #          | Pin Name                                   | Description                                       |
|----------------|--|---|
| 1              | N/C  | No connect  |
| 2              | V <sub>DD</sub>                            | Supply voltage                                    |
| 3              | $\bar{P}/S$                                | Serial/parallel mode select                       |
| 4              | A0   | Address bit A0 connection                         |
| 5, 6, 8-17, 19 | GND  | Ground  |
| 7              | RF1 <sup>1</sup>                           | RF1 port (RF input)                               |
| 18             | RF2 <sup>1</sup>                           | RF2 port (RF output)                              |
| 20             | V <sub>SS<sub>EXT</sub></sub> <sup>2</sup> | External V <sub>ss</sub> negative voltage control |
| 21             | A2   | Address bit A2 connection                         |
| 22             | A1   | Address bit A1 connection                         |
| 23             | LE   | Serial interface latch enable input               |
| 24             | CLK  | Serial interface clock input                      |
| 25             | SI   | Serial interface data input                       |
| 26             | C16 (D6) <sup>3</sup>                      | Parallel control bit, 16 dB                       |
| 27             | C8 (D5) <sup>3</sup>                       | Parallel control bit, 8 dB                        |
| 28             | C4 (D4) <sup>3</sup>                       | Parallel control bit, 4 dB                        |
| 29             | C2 (D3) <sup>3</sup>                       | Parallel control bit, 2 dB                        |
| 30             | C1 (D2) <sup>3</sup>                       | Parallel control bit, 1 dB                        |
| 31             | C0.5 (D1) <sup>3</sup>                     | Parallel control bit, 0.5 dB                      |
| 32             | C0.25 (D0) <sup>3</sup>                    | Parallel control bit, 0.25 dB                     |
| Pad            | GND  | Exposed pad: ground for proper operation          |

Notes: 1. RF pins 7 and 18 must be at 0V DC. The RF pins do not require DC blocking capacitors for proper operation if the 0V DC requirement is met  
 2. Use V<sub>SS<sub>EXT</sub></sub> (pin 20) to bypass and disable internal negative voltage generator. Connect V<sub>SS<sub>EXT</sub></sub> (pin 20) to GND (V<sub>SS<sub>EXT</sub></sub> = 0V) to enable internal negative voltage generator  
 3. Ground C0.25, C0.5, C1 C2, C4, C8, C16 if not in use

Table 5. Operating Ranges

| Parameter  | Symbol                        | Min  | Typ | Max            | Unit       |
|--|-------------------------------|------|-----|----------------|------------|
| Supply voltage (normal mode, V <sub>SS<sub>EXT</sub></sub> = 0V) <sup>1</sup>  | V <sub>DD</sub>               | 2.3  |     | 5.5            | V          |
| Supply voltage (bypass mode, V <sub>SS<sub>EXT</sub></sub> = -3.4V, V <sub>DD</sub> ≥ 3.4V for full spec. compliance) <sup>2</sup> | V <sub>DD</sub>               | 2.7  | 3.4 | 5.5            | V          |
| Negative supply voltage (bypass mode) <sup>2</sup>   | V <sub>SS<sub>EXT</sub></sub> | -3.6 |     | -2.4           | V          |
| Supply current (normal mode, V <sub>SS<sub>EXT</sub></sub> = 0V) <sup>1</sup>  | I <sub>DD</sub>               |      | 130 | 200            | μA         |
| Supply current (bypass mode, V <sub>SS<sub>EXT</sub></sub> = -3.4V) <sup>2</sup>   | I <sub>DD</sub>               |      | 50  | 80             | μA         |
| Negative supply current (bypass mode, V <sub>SS<sub>EXT</sub></sub> = -3.4V) <sup>2</sup>  | I <sub>SS</sub>               | -40  | -16 |                | μA         |
| Digital input high   | V <sub>IH</sub>               | 1.17 |     | 3.6            | V          |
| Digital input low  | V <sub>IL</sub>               | -0.3 |     | 0.6            | V          |
| Digital input current  | I <sub>CTRL</sub>             |      |     | 15             | μA         |
| RF input power, CW <sup>3</sup><br>9 kHz < 50 MHz<br>50 MHz ≤ 8 GHz  | P <sub>MAX,CW</sub>           |      |     | see Fig. 4 +28 | dBm<br>dBm |
| RF input power, pulsed <sup>4</sup><br>9 kHz < 50 MHz<br>50 MHz ≤ 8 GHz  | P <sub>MAX,PULSED</sub>       |      |     | see Fig. 4 +31 | dBm<br>dBm |
| Operating temperature range  | T <sub>OP</sub>               | -40  | 25  | +85            | °C         |

Notes: 1. Normal mode: connect V<sub>SS<sub>EXT</sub></sub> (pin 20) to GND (V<sub>SS<sub>EXT</sub></sub> = 0V) to enable internal negative voltage generator  
 2. Bypass mode: use V<sub>SS<sub>EXT</sub></sub> (pin 20) to bypass and disable internal negative voltage generator  
 3. 100% duty cycle, all bands, 50Ω  
 4. Pulsed, 5% duty cycle of 4620 μs period, 50Ω

**Table 6. Absolute Maximum Ratings**

| Parameter/Condition                                     | Symbol        | Min  | Max                  | Unit       |
|---|---------------|------|----------------------|------------|
| Supply voltage  | $V_{DD}$      | -0.3 | 5.5                  | V          |
| Digital input voltage                                   | $V_{CTRL}$    | -0.3 | 3.6                  | V          |
| RF input power, max<br>9 kHz < 50 MHz<br>50 MHz ≤ 8 GHz | $P_{MAX,ABS}$ |      | see<br>Fig. 4<br>+34 | dBm<br>dBm |
| Storage temperature range                               | $T_{ST}$      | -65  | +150                 | °C         |
| ESD voltage HBM <sup>1</sup> , all pins                 | $V_{ESD,HBM}$ |      | 1500                 | V          |
| ESD voltage MM <sup>2</sup> , all pins                  | $V_{ESD,MM}$  |      | 200                  | V          |
| ESD voltage CDM <sup>3</sup> , all pins                 | $V_{ESD,CDM}$ |      | 250                  | V          |

Notes: 1. Human Body Model (MIL-STD 883 Method 3015)  
2. Machine Model (JEDEC JESD22-A115)

Exceeding absolute maximum ratings may cause permanent damage. Operation should be restricted to the limits in the Operating Ranges table. Operation between operating range maximum and absolute maximum for extended periods may reduce reliability.

### Electrostatic Discharge (ESD) Precautions

When handling this UltraCMOS<sup>®</sup> device, observe the same precautions that you would use with other ESD-sensitive devices. Although this device contains circuitry to protect it from damage due to ESD, precautions should be taken to avoid exceeding the specified rating.

### Latch-Up Avoidance

Unlike conventional CMOS devices, UltraCMOS<sup>®</sup> devices are immune to latch-up.

### Moisture Sensitivity Level

The moisture sensitivity level rating for the PE43704 in the 5x5 QFN package is MSL1.

### Switching Frequency

The PE43704 has a maximum 25 kHz switching rate when the internal negative voltage generator is used (pin 20 = GND). The rate at which the PE43704 can be switched is only limited to the switching time (*Tables 1-3*) if an external negative supply is provided (pin 20 =  $V_{SS_{EXT}}$ ).

Switching frequency is defined to be the speed at which the DSA can be toggled across attenuation states. Switching time is the time duration between the point the control signal reaches 50% of the final value and the point the output signal

### Optional External Vss Control ( $V_{SS_{EXT}}$ )

For proper operation, the  $V_{SS_{EXT}}$  control pin must be grounded or tied to the  $V_{SS}$  voltage specified in *Table 5*. When the  $V_{SS_{EXT}}$  control pin is grounded, FETs in the switch are biased with an internal voltage generator. For applications that require the lowest possible spur performance,  $V_{SS_{EXT}}$  can be applied externally to bypass the internal

**Table 7. Latch and Clock Specifications**

| Latch Enable | Shift Clock | Function  |
|--------------|-------------|---|
| 0            | ↑           | Shift register clocked                                    |
| ↑            | X           | Contents of shift register transferred to attenuator core |

### Safe Attenuation State Transitions

The PE43704 features a novel architecture to provide safe transition behavior when changing attenuation states. When RF input power is applied, positive output power spikes are prevented during attenuation state changes by optimized internal timing control.

Figure 4. Power De-rating Curve (50Ω, -40°C to 85°C Ambient)

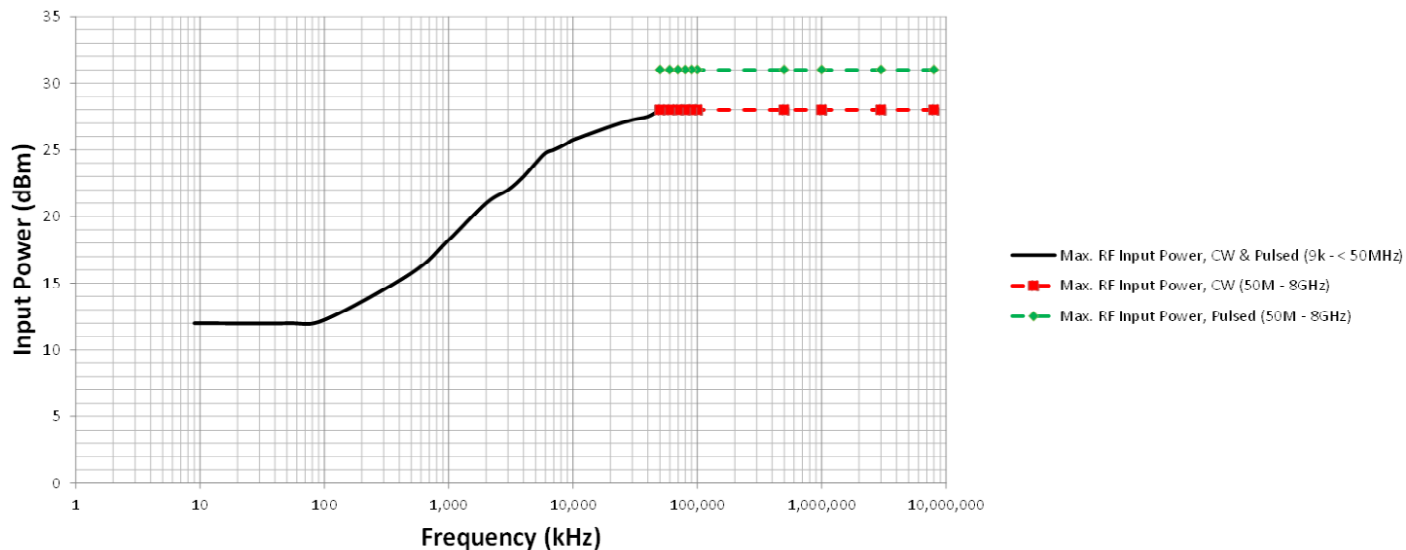


Table 8. Parallel Truth Table

| Parallel Control Setting |    |    |    |    |    |    | Attenuation Setting<br>RF1-RF2 |
|--------------------------|----|----|----|----|----|----|--------------------------------|
| D6                       | D5 | D4 | D3 | D2 | D1 | D0 |                                |
| L                        | L  | L  | L  | L  | L  | L  | Reference I.L.                 |
| L                        | L  | L  | L  | L  | L  | H  | 0.25 dB                        |
| L                        | L  | L  | L  | L  | H  | L  | 0.5 dB                         |
| L                        | L  | L  | L  | H  | L  | L  | 1 dB                           |
| L                        | L  | L  | H  | L  | L  | L  | 2 dB                           |
| L                        | L  | H  | L  | L  | L  | L  | 4 dB                           |
| L                        | H  | L  | L  | L  | L  | L  | 8 dB                           |
| H                        | L  | L  | L  | L  | L  | L  | 16 dB                          |
| H                        | H  | H  | H  | H  | H  | H  | 31.75 dB                       |

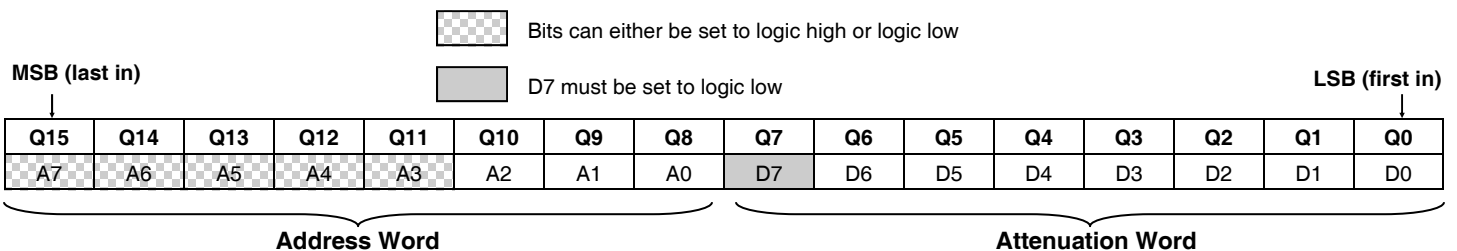
Table 9. Serial Attenuation Word Truth Table

| Attenuation Word |    |    |    |    |    |    |          | Attenuation Setting<br>RF1-RF2 |
|------------------|----|----|----|----|----|----|----------|--------------------------------|
| D7               | D6 | D5 | D4 | D3 | D2 | D1 | D0 (LSB) |                                |
| L                | L  | L  | L  | L  | L  | L  | L        | Reference I.L.                 |
| L                | L  | L  | L  | L  | L  | L  | H        | 0.25 dB                        |
| L                | L  | L  | L  | L  | L  | H  | L        | 0.5 dB                         |
| L                | L  | L  | L  | L  | H  | L  | L        | 1 dB                           |
| L                | L  | L  | L  | H  | L  | L  | L        | 2 dB                           |
| L                | L  | L  | H  | L  | L  | L  | L        | 4 dB                           |
| L                | L  | H  | L  | L  | L  | L  | L        | 8 dB                           |
| L                | H  | L  | L  | L  | L  | L  | L        | 16 dB                          |
| L                | H  | H  | H  | H  | H  | H  | H        | 31.75 dB                       |

Table 10. Serial Address Word Truth Table

| Address Word |    |    |    |    |    |    |    | Address Setting |
|--------------|----|----|----|----|----|----|----|-----------------|
| A7 (MSB)     | A6 | A5 | A4 | A3 | A2 | A1 | A0 |                 |
| X            | X  | X  | X  | X  | L  | L  | L  | 000             |
| X            | X  | X  | X  | X  | L  | L  | H  | 001             |
| X            | X  | X  | X  | X  | L  | H  | L  | 010             |
| X            | X  | X  | X  | X  | L  | H  | H  | 011             |
| X            | X  | X  | X  | X  | H  | L  | L  | 100             |
| X            | X  | X  | X  | X  | H  | L  | H  | 101             |
| X            | X  | X  | X  | X  | H  | H  | L  | 110             |
| X            | X  | X  | X  | X  | H  | H  | H  | 111             |

Table 11. Serial-Addressable Register Map



Attenuation word is derived directly from the attenuation value. For example, to program the 18.25 dB state at address 3:

Address word: XXXXX011

Attenuation word: Multiply by 4 and convert to binary → 4 \* 18.25 dB → 73 → 01001001

Serial input: XXXXX01101001001



## Programming Options

### Parallel/Serial Selection

Either a parallel or serial-addressable interface can be used to control the PE43704. The  $\bar{P}/S$  bit provides this selection, with  $\bar{P}/S = \text{LOW}$  selecting the parallel interface and  $\bar{P}/S = \text{HIGH}$  selecting the serial-addressable interface.

### Parallel Mode Interface

The parallel interface consists of seven CMOS-compatible control lines that select the desired attenuation state, as shown in *Table 8*.

The parallel interface timing requirements are defined by *Figure 6* (Parallel Interface Timing Diagram), *Table 13* (Parallel and Direct Interface AC Characteristics) and switching time (*Tables 1-3*).

For *latched*-parallel programming the latch enable (LE) should be held LOW while changing attenuation state control values, then pulse LE HIGH to LOW (*per Figure 6*) to latch new attenuation state into device.

For *direct* parallel programming, the LE line should be pulled HIGH. Changing attenuation state control values will change device state to new attenuation. Direct mode is ideal for manual control of the device (using hardwire, switches, or jumpers).

In parallel mode, serial-in (SI) and clock (CLK) pins are “don’t care” and may be tied to logic LOW or logic HIGH.

### Serial Interface

The serial-addressable interface is a 16-bit serial-in, parallel-out shift register buffered by a transparent latch. The 16-bits make up two words comprised of 8-bits each. The first word is the Attenuation Word, which controls the state of the DSA. The second word is the Address Word, which is compared to the static (or programmed) logical states of the A0, A1 and A2 digital inputs. If there is an address match, the DSA changes state; otherwise its current state will remain unchanged. *Figure 5* illustrates an example timing diagram for programming a state. It is required that all parallel control inputs be grounded when the DSA is used in serial-addressable mode.

The serial-interface is controlled using three CMOS-compatible signals: serial-in (SI), clock (CLK), and latch

enable (LE). The SI and CLK inputs allow data to be serially entered into the shift register. Serial data is clocked in LSB first, beginning with the attenuation word.

The shift register must be loaded while LE is held LOW to prevent the attenuator value from changing as data is entered. The LE input should then be toggled HIGH and brought LOW again, latching the new data into the DSA. Attenuation word and address word truth tables are listed in *Table 9* and *Table 10*. A programming example of the serial register is illustrated in *Table 11*. The serial timing diagram is illustrated in *Figure 5*.

### Power-up Control Settings

The PE43704 will always initialize to the maximum attenuation setting (31.75 dB) on power-up for both the serial-addressable and latched-parallel modes of operation and will remain in this setting until the user latches in the next programming word. In direct-parallel mode, the DSA can be preset to any state within the 31.75 dB range by pre-setting the parallel control pins prior to power-up. In this mode, there is a 400- $\mu\text{s}$  delay between the time the DSA is powered-up to the time the desired state is set. During this power-up delay, the device attenuates to the maximum attenuation setting (31.75 dB) before defaulting to the user defined state. If the control pins are left floating in this mode during power-up, the device will default to the minimum attenuation setting (insertion loss state).

Dynamic operation between serial and parallel programming modes is possible.

If the DSA powers up in serial mode ( $\bar{P}/S = \text{HIGH}$ ), all the parallel control inputs DI[6:0] must be set to logic low. Prior to toggling to parallel mode, the DSA *must* be programmed serially to ensure D[7] is set to logic low.

If the DSA powers up in either latched or direct-parallel mode, all parallel pins DI[6:0] must be set to logic low prior to toggling to serial-addressable mode ( $\bar{P}/S = \text{HIGH}$ ), and *held* low until the DSA has been programmed serially to ensure bit D[7] is set to logic low.

The sequencing is only required once on power-up. Once completed, the DSA may be toggled between serial and parallel programming modes at will.

Figure 5. Serial Addressable Timing Diagram

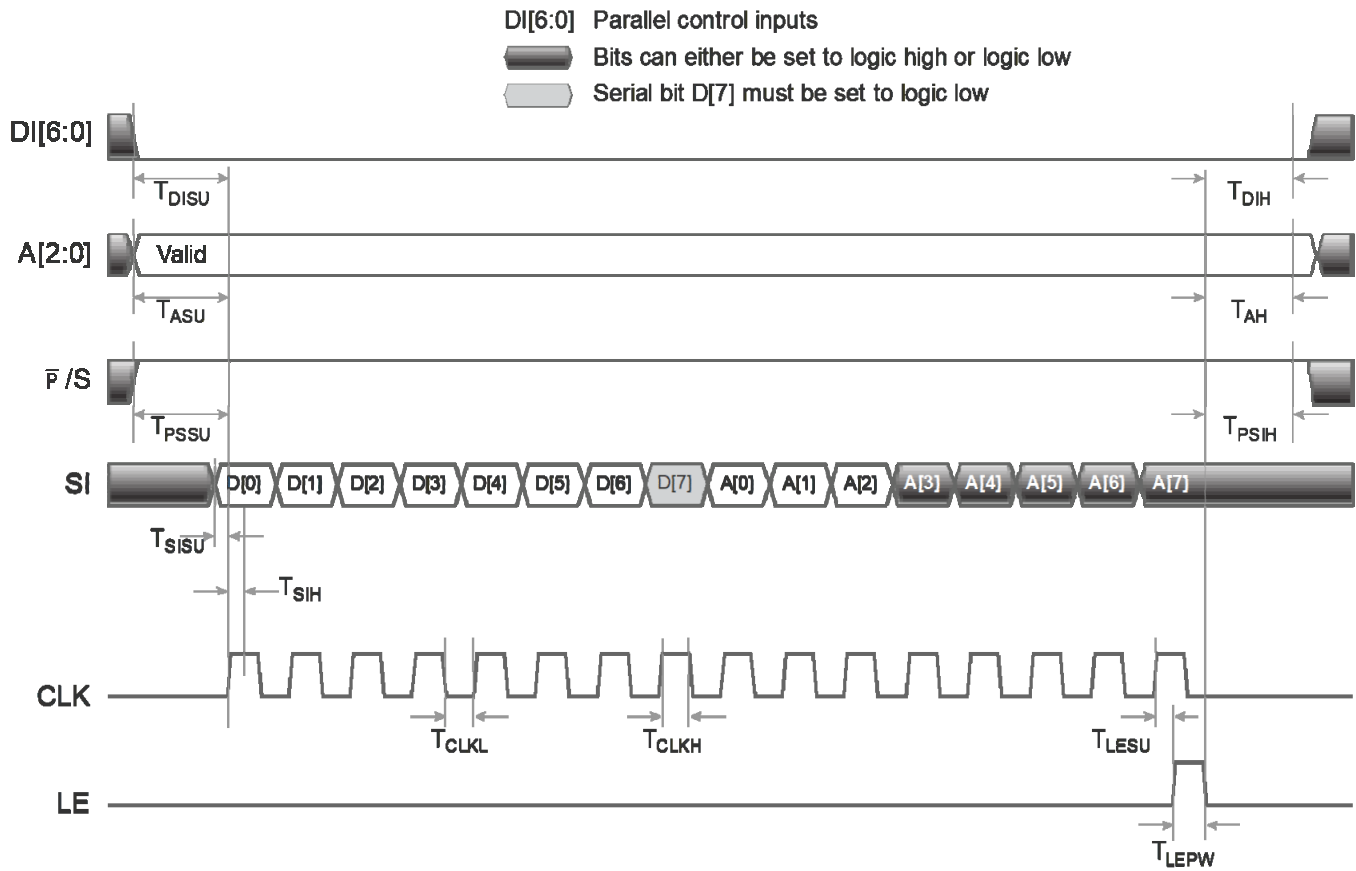
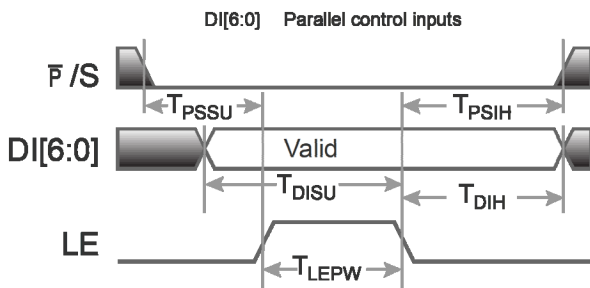


Figure 6. Latched-Parallel/Direct-Parallel Timing Diagram



**Table 12. Serial Interface AC Characteristics**
 $V_{DD} = 3.4V$  or  $5.0V$ ,  $-40^{\circ}C < T_A < 85^{\circ}C$ , unless otherwise specified

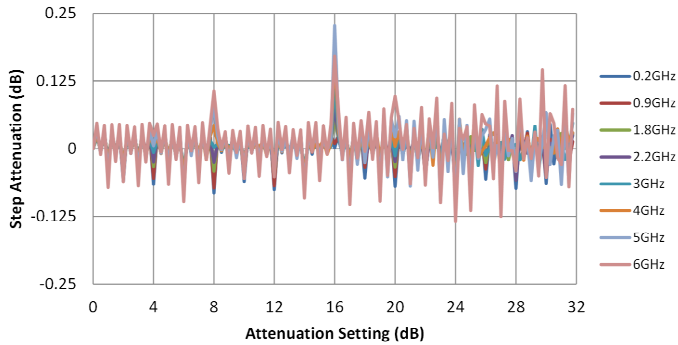
| Parameter  | Symbol     | Min | Max | Unit |
|--|------------|-----|-----|------|
| Serial clock frequency   | $F_{CLK}$  | -   | 10  | MHz  |
| Serial clock HIGH time   | $T_{CLKH}$ | 30  | -   | ns   |
| Serial clock LOW time  | $T_{CLKL}$ | 30  | -   | ns   |
| Last serial clock rising edge setup time to Latch Enable rising edge | $T_{LESU}$ | 10  | -   | ns   |
| Latch enable min. pulse width  | $T_{LEPW}$ | 30  | -   | ns   |
| Serial data setup time   | $T_{SISU}$ | 10  | -   | ns   |
| Serial data hold time  | $T_{SIH}$  | 10  | -   | ns   |
| Parallel data setup time   | $T_{DISU}$ | 100 | -   | ns   |
| Parallel data hold time  | $T_{DIH}$  | 100 | -   | ns   |
| Address setup time   | $T_{ASU}$  | 100 | -   | ns   |
| Address hold time  | $T_{AH}$   | 100 | -   | ns   |
| Parallel/serial setup time   | $T_{PSSU}$ | 100 | -   | ns   |
| Parallel/serial hold time  | $T_{PSIH}$ | 100 | -   | ns   |

**Table 13. Parallel and Direct Interface AC Characteristics**
 $V_{DD} = 3.4V$  or  $5.0V$ ,  $-40^{\circ}C < T_A < 85^{\circ}C$ , unless otherwise specified

| Symbol     | Parameter                        | Min | Max | Unit |
|------------|----------------------------------|-----|-----|------|
| $T_{LEPW}$ | Latch enable minimum pulse width | 30  | -   | ns   |
| $T_{DISU}$ | Parallel data setup time         | 100 | -   | ns   |
| $T_{DIH}$  | Parallel data hold time          | 100 | -   | ns   |
| $T_{PSSU}$ | Parallel/serial setup time       | 100 | -   | ns   |
| $T_{PSIH}$ | Parallel/serial hold time        | 100 | -   | ns   |

Typical Performance Data, 0.25 dB Step @ 25°C and  $V_{DD} = 3.4V$  unless otherwise specified

Figure 7. 0.25 dB Step Attenuation vs. Frequency\*



\* Monotonicity is held so long as step-attenuation does not cross below -0.25 dB

Figure 8. 0.25 dB Step, Actual vs. Frequency

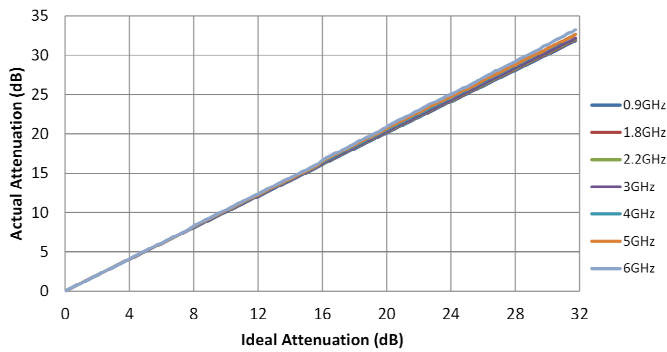


Figure 9. 0.25 dB Major State Bit Error vs. Attenuation Setting

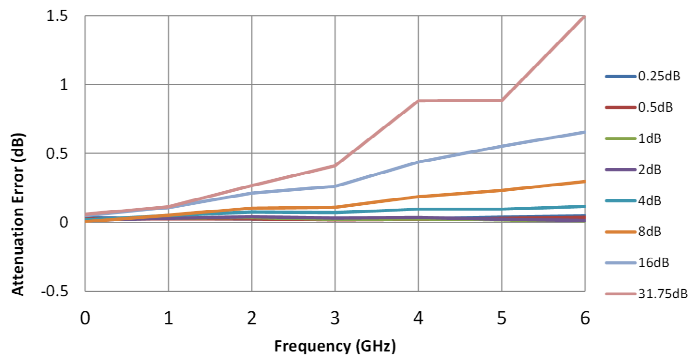
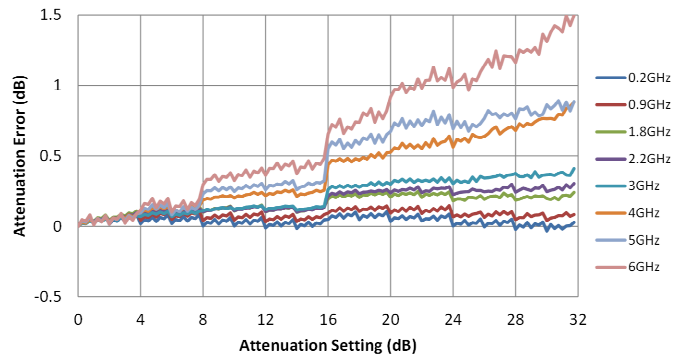
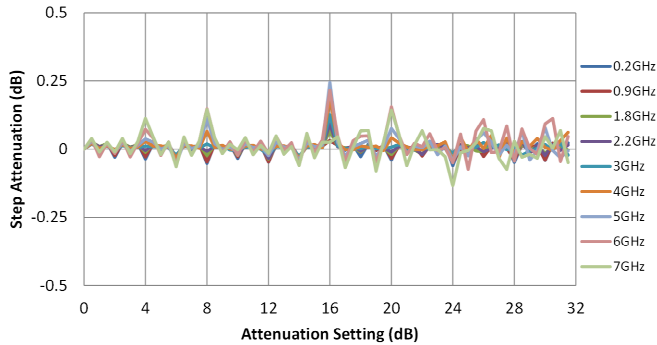


Figure 10. 0.25 dB Attenuation Error vs. Frequency



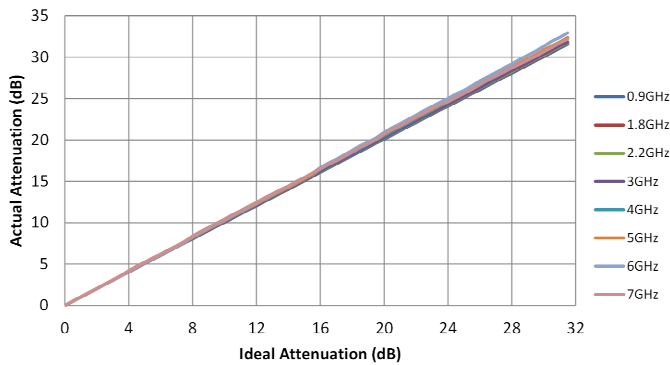
**Typical Performance Data, 0.5 dB Step @ 25°C and  $V_{DD} = 3.4V$  unless otherwise specified**

**Figure 11. 0.5 dB Step Attenuation vs. Frequency\***

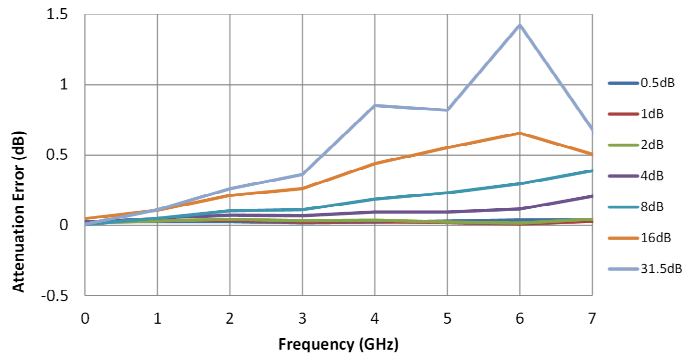


\* Monotonicity is held so long as step-attenuation does not cross below -0.5 dB

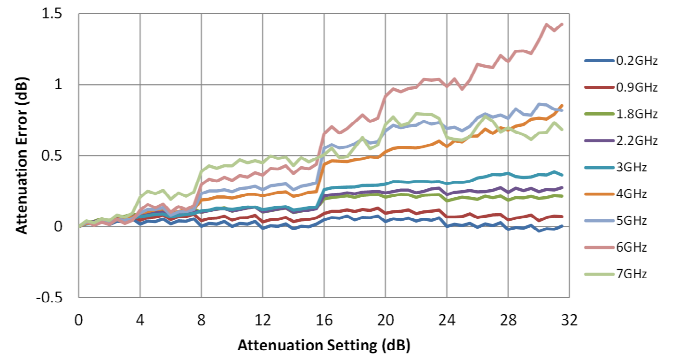
**Figure 12. 0.5 dB Step, Actual vs. Frequency**



**Figure 13. 0.5 dB Major State Bit Error vs. Attenuation Setting**

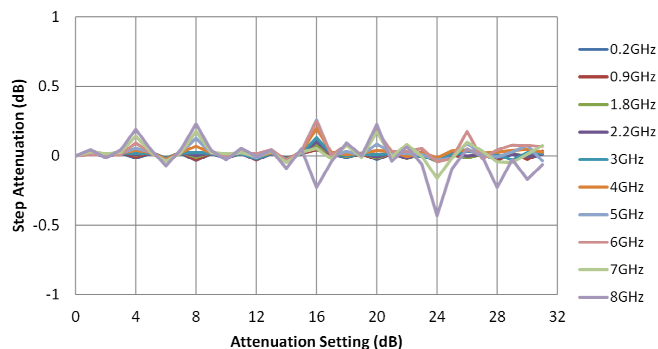


**Figure 14. 0.5 dB Attenuation Error vs. Frequency**



Typical Performance Data, 1 dB Step @ 25°C and  $V_{DD} = 3.4V$  unless otherwise specified

Figure 15. 1 dB Step Attenuation vs. Frequency\*



\* Monotonicity is held so long as step-attenuation does not cross below -1.0 dB

Figure 16. 1 dB Step, Actual vs. Frequency

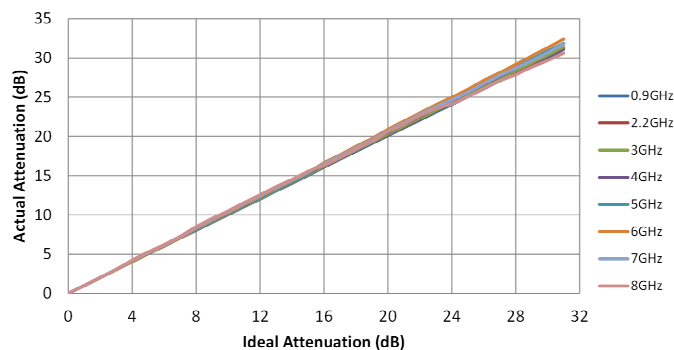
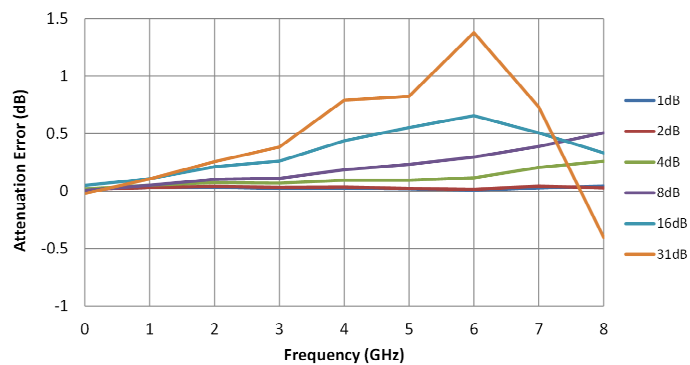
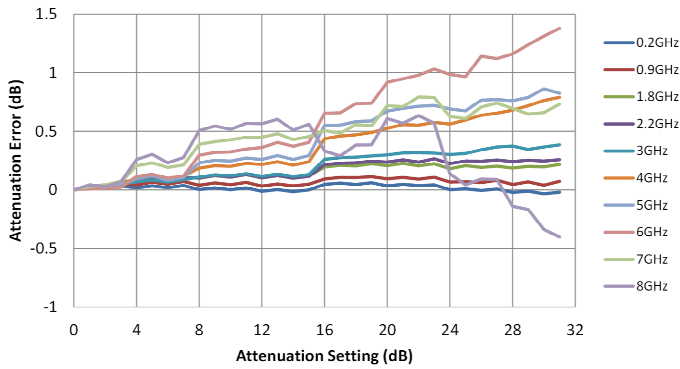


Figure 17. 1 dB Major State Bit Error vs. Attenuation Setting

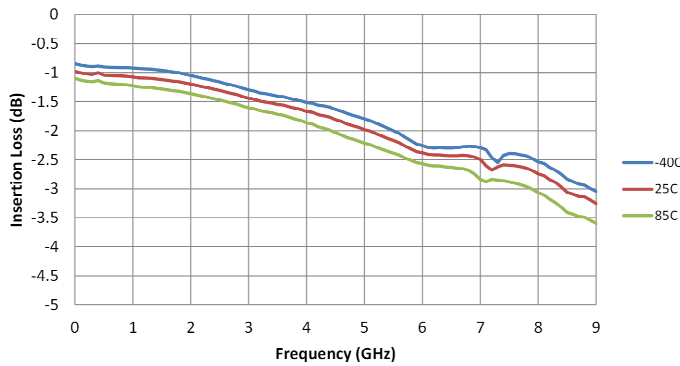


Typical Performance Data, 1 dB Step @ 25°C and  $V_{DD} = 3.4V$  unless otherwise specified

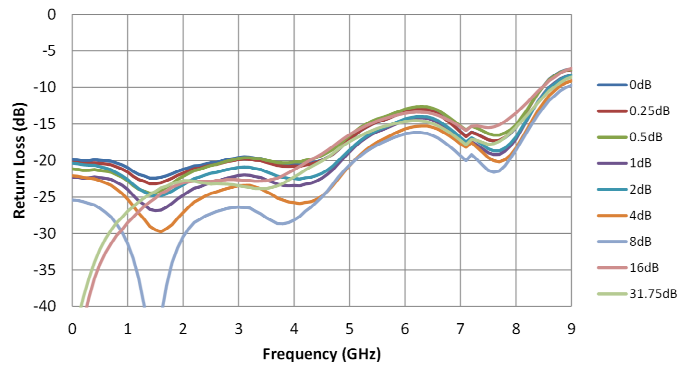
**Figure 18. 1 dB Attenuation Error vs. Frequency**



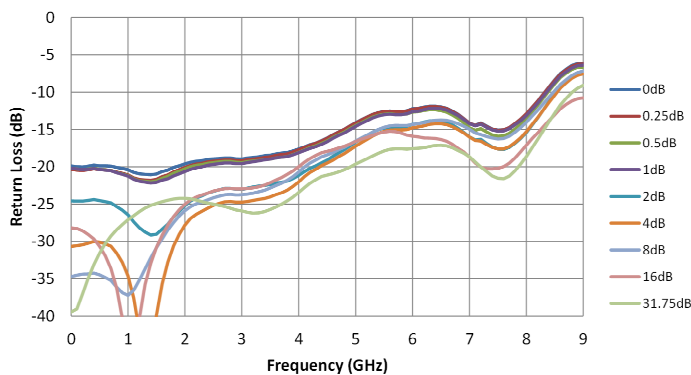
**Figure 19. Insertion Loss vs. Temperature**



**Figure 20. Input Return Loss vs. Attenuation Setting**



**Figure 21. Output Return Loss vs. Attenuation Setting**



Typical Performance Data, 1 dB Step @ 25°C and  $V_{DD} = 3.4V$  unless otherwise specified

Figure 22. Input Return Loss vs. Temperature for 16 dB Attenuation Setting

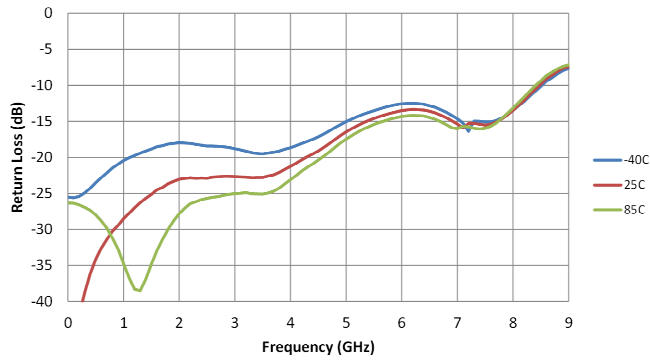
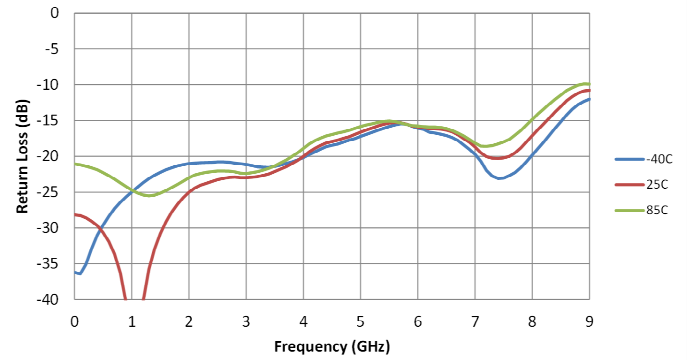


Figure 23. Output Return Loss vs. Temperature for 16 dB Attenuation Setting





Typical Performance Data @ 25°C and V<sub>DD</sub> = 3.4V unless otherwise specified

Figure 24. Relative Phase Error vs. Attenuation Setting

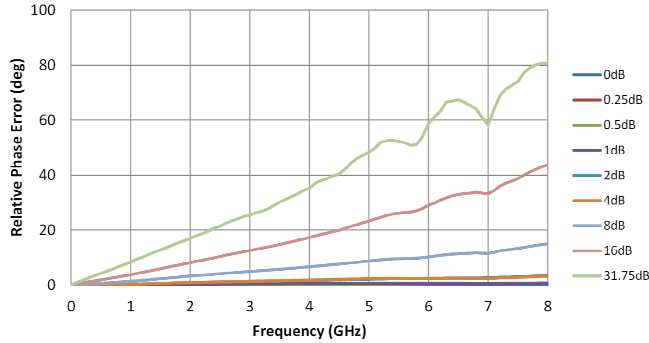


Figure 25. Relative Phase Error for 31.75 dB Attenuation Setting vs. Frequency

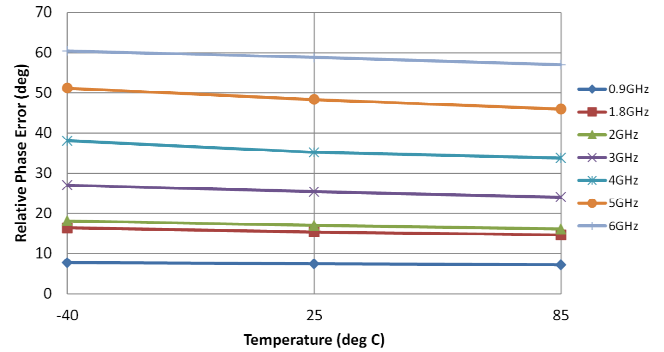


Figure 26. Attenuation Error @ 900 MHz vs. Temperature

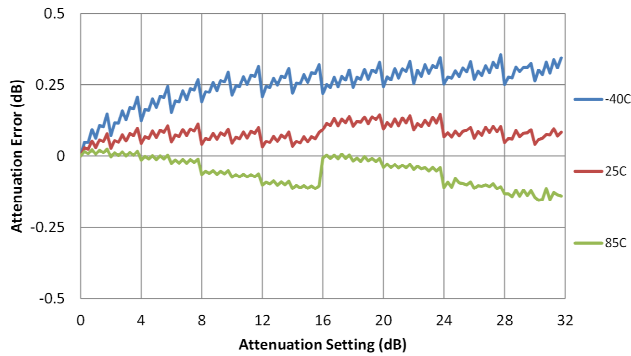


Figure 27. Attenuation Error @ 1800 MHz vs. Temperature

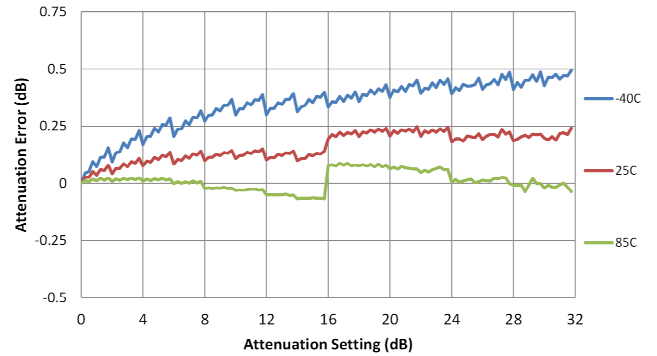


Figure 28. Attenuation Error @ 3000 MHz vs. Temperature

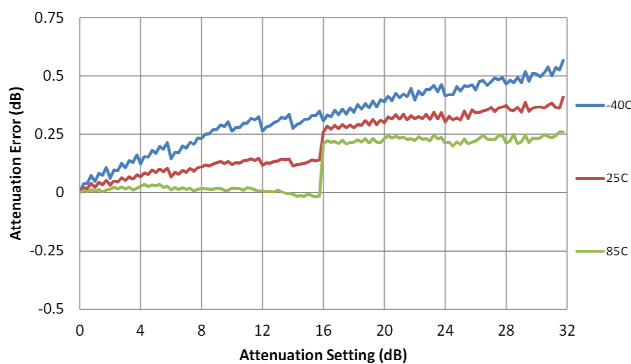
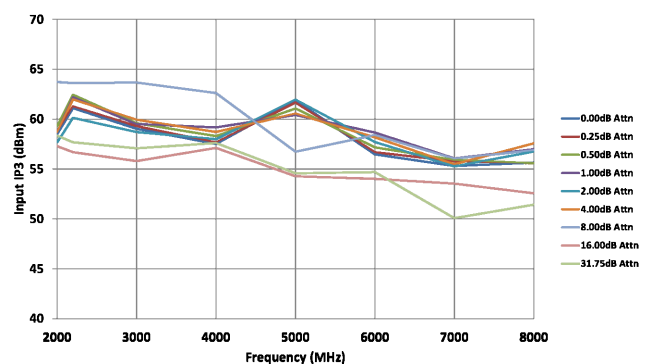


Figure 29. IIP3 vs. Attenuation Setting



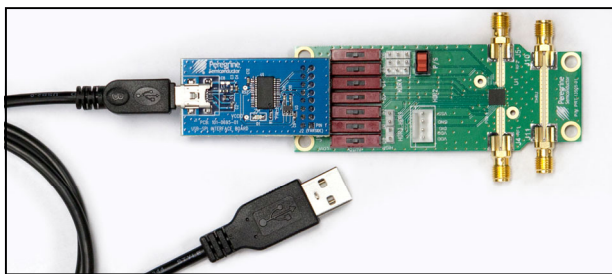
## Evaluation Kit

The Digital Attenuator Evaluation Board (EVB) was designed to ease customer evaluation of the PE43704 digital step attenuator. PE43704 EVB supports direct-parallel, latched-parallel, and serial modes.

### Evaluation Kit Setup

Connect the EVB with the USB dongle board and USB cable as shown in *Figure 30*.

**Figure 30. Evaluation Kit**



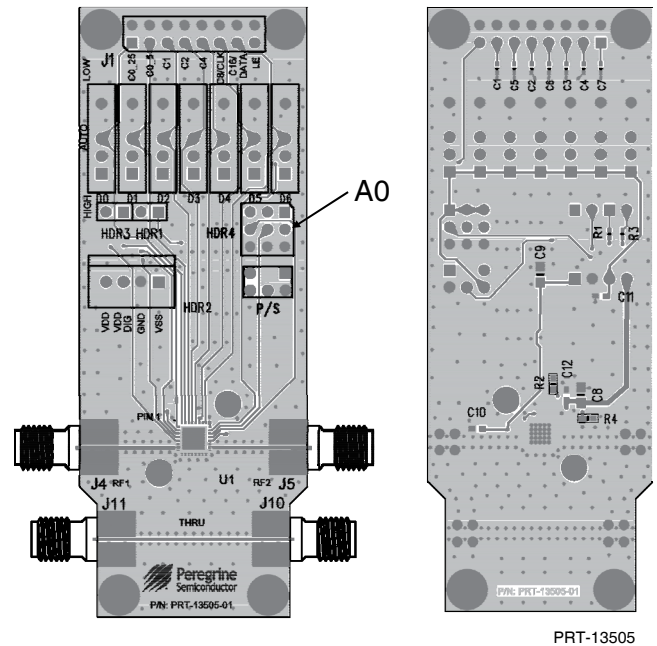
### Direct-Parallel Programming Procedure

Direct-parallel programming is suitable for manual operation without software programming. For manual direct-parallel programming, position the parallel/serial (P/S) select switch to the parallel (or left) position. The LE pin of J1 (pin 15) must be tied to HIGH voltage. Switches D0–D6 are SP3T switches that enable the user to manually program the parallel bits. When D0–D6 are toggled to the ‘HIGH’ position, logic high is presented to the parallel input. When toggled to the ‘LOW’ position, logic low is presented to the parallel input. Setting D0–D6 to the ‘AUTO’ position presents as OPEN, which is set for software programming of latched-parallel and serial mode. *Table 8* depicts the parallel programming truth table.

### Latched-Parallel Programming Procedure

For automated latched-parallel programming, connect the USB dongle board and cable that is provided with the evaluation kit (EVK) from the USB port of the PC to the J1 header of the PE43704 EVB, and set the D0–D6 SP3T switches to the ‘AUTO’ position. Position the parallel/serial (P/S) select switch to the parallel (or left) position.

**Figure 31. Evaluation Board Layout**

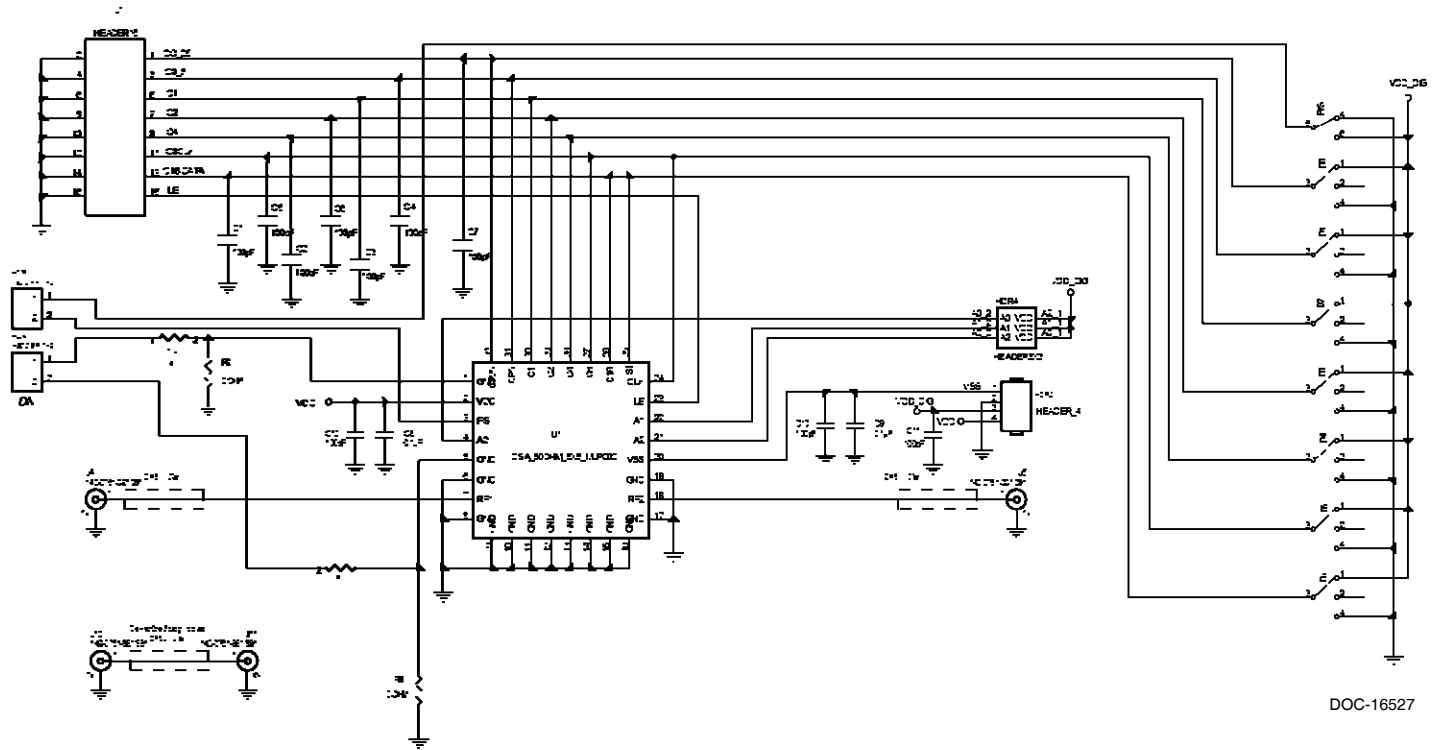


The evaluation software is written to operate the DSA in parallel mode. Ensure that the software GUI is set to latched-parallel mode. Use the software GUI to enable the desired attenuation state. The software GUI automatically programs the DSA each time an attenuation state is enabled.

### Serial-Addressable Programming Procedure

For automated serial programming, connect the USB dongle board and cable that is provided with the evaluation kit (EVK) from the USB port of the PC to the J1 header of the PE43704 EVB, and set the D0–D6 SP3T switches to the ‘AUTO’ toggle position. Position the parallel/serial (P/S) select switch to the serial (or right) position. Prior to programming, the user must define an address setting using the HDR4 header pin. Jump the middle row of pins on the HDR4 header (A0–A2) to the lower row of pins to set logic low, or jump the middle row of pins to the upper row of pins to set logic high. If the HDR4 pins are left open, then 000 becomes the default address. The software GUI is written to operate the DSA in serial mode. Use the software GUI to enable each setting to the desired attenuation state. The software GUI automatically programs the DSA each time an attenuation state is enabled.

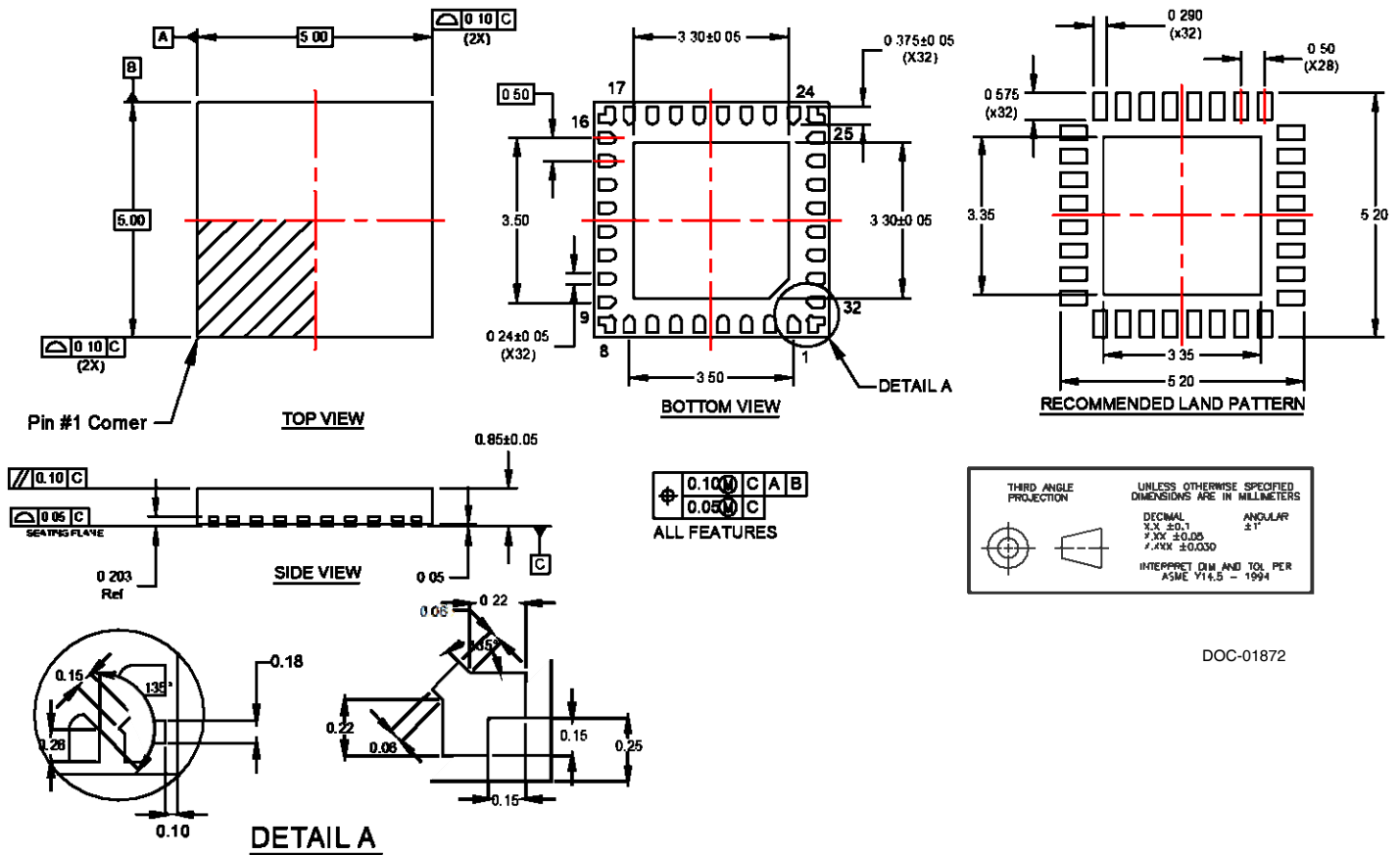
**Figure 32. Evaluation Board Schematic**



DOC-16527

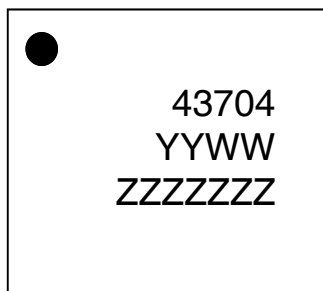
- NOTES:**
- 1. USE PART NUMBER 01 P13
  - 2. CAUTION: JOA HAS PARTS AND ASSEMBLIES SUSCEPTIBLE TO DAMAGE BY ELECTROSTATIC DISCHARGE (ESD)

**Figure 33. Package Drawing**  
32-lead 5x5 QFN



DOC-01872

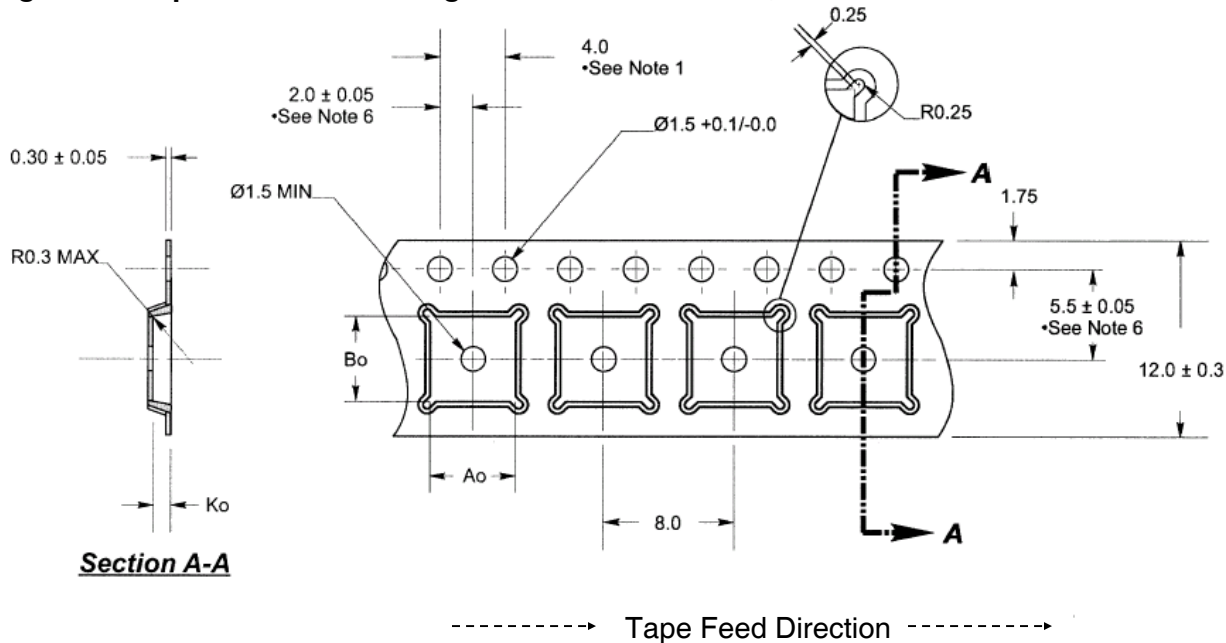
**Figure 34. Top Marking Specification**



DOC-66072

- = Pin 1 designator
- YY = Last two digits of assembly year
- WW = Assembly work week
- ZZZZZZZ = Assembly lot code (maximum seven characters)

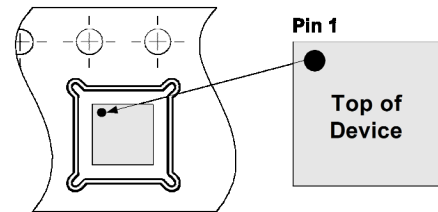
**Figure 35. Tape and Reel Drawing**



**Section A-A**

- Notes:
1. 10 sprocket hole pitch cumulative tolerance  $\pm 0.02$
  2. Camber not to exceed 1 mm in 100 mm
  3. Material: PS + C
  4.  $A_o$  and  $B_o$  measured as indicated
  5.  $K_o$  measured from a plane on the inside bottom of the pocket to the top surface of the carrier
  6. Pocket position relative to sprocket hole measured as true position of pocket, not pocket hole

$A_o = 5.25$  mm  
 $B_o = 5.25$  mm  
 $K_o = 1.1$  mm



**Device Orientation in Tape**

**Table 14. Ordering Information**

| Order Code | Description                     | Package            | Shipping Method  |
|------------|---------------------------------|--------------------|------------------|
| PE43704B-Z | PE43704 Digital step attenuator | 32-lead 5x5 mm QFN | 3000 units / T&R |
| EK43704-12 | PE43704 Evaluation kit          | Evaluation kit     | 1 / Box          |

**Sales Contact and Information**

For sales and contact information please visit [www.psemi.com](http://www.psemi.com).

**Advance Information:** The product is in a formative or design stage. The datasheet contains design target specifications for product development. Specifications and features may change in any manner without notice.  
**Preliminary Specification:** The datasheet contains preliminary data. Additional data may be added at a later date. pSemi reserves the right to change specifications at any time without notice in order to supply the best possible product.  
**Product Specification:** The datasheet contains final data. In the event pSemi decides to change the specifications, pSemi will notify customers of the intended changes by issuing a CNF (Customer Notification Form).  
The information in this document is believed to be reliable. However, pSemi assumes no liability for the use of this information. Use shall be entirely at the user's own risk.

No patent rights or licenses to any circuits described in this document are implied or granted to any third party. pSemi's products are not designed or intended for use in devices or systems intended for surgical implant, or in other applications intended to support or sustain life, or in any application in which the failure of the pSemi product could create a situation in which personal injury or death might occur. pSemi assumes no liability for damages, including consequential or incidental damages, arising out of the use of its products in such applications.  
The Peregrine Semiconductor name, Peregrine Semiconductor logo and UltraCMOS are registered trademarks and the pSemi name, pSemi logo, HaRP and DuNE are trademarks of pSemi Corporation in the U.S. and other countries.  
pSemi products are protected under one or more of the following U.S. patents: [patents.psemi.com](http://patents.psemi.com).