

Evaluation Board for the **AD5677R** 16-Bit, 16-Channel, Voltage Output DAC

FEATURES

- Full featured evaluation board for the **AD5677R**
- Compatible with the **AD5673R**
- Various link options
- PC control in conjunction with the Analog Devices, Inc., **SDP-B** board

EVALUATION KIT CONTENTS

EVAL-AD5677RSDZ

HARDWARE REQUIRED

EVAL-SDP-CB1Z (SDP-B) board, must be purchased separately

SOFTWARE REQUIRED

Analysis | Control | Evaluation software, available for download from the **EVAL-AD5679RSDZ** product page

GENERAL DESCRIPTION

This user guide describes the operation of the EVAL-AD5677RSDZ for the **AD5677R** 16-bit, 16-channel, voltage output, digital-to-analog converter (DAC). The EVAL-AD5677RSDZ is also compatible with the **AD5673R**.

The EVAL-AD5677RSDZ allows users to quickly prototype **AD5673R/AD5677R** circuits and reduce design time. The

AD5673R/AD5677R operates from a single 2.7 V to 5.5 V supply range. The **AD5673R/AD5677R** incorporates an internal 2.5 V reference to provide an output voltage of 2.5 V or 5 V. The EVAL-AD5677RSDZ also incorporates an additional on-board voltage reference.

The EVAL-AD5677RSDZ interfaces to the USB port of a PC via a system demonstration platform (**SDP-B**) board. The Analysis | Control | Evaluation (**ACE**) software is available for download from the EVAL-AD5677RSDZ product page. Use this software with the evaluation board to program the **AD5673R/AD5677R**. A peripheral module interface (PMOD) connection is also available to allow the connection of microcontrollers to the evaluation board without the **SDP-B** board. When a microcontroller is used through the PMOD connection, the **SDP-B** board must be disconnected, and the user is unable to operate the **ACE** software.

The EVAL-AD5677RSDZ is compatible with any Analog Devices **SDP-B** board, which can be purchased separately. A typical connection between the EVAL-AD5677RSDZ and the **SDP-B** controller board is shown in Figure 1.

For full details, see the **AD5673R/AD5677R** data sheet, which must be used in conjunction with this user guide when using the EVAL-AD5677RSDZ.

EVALUATION BOARD PHOTOGRAPH

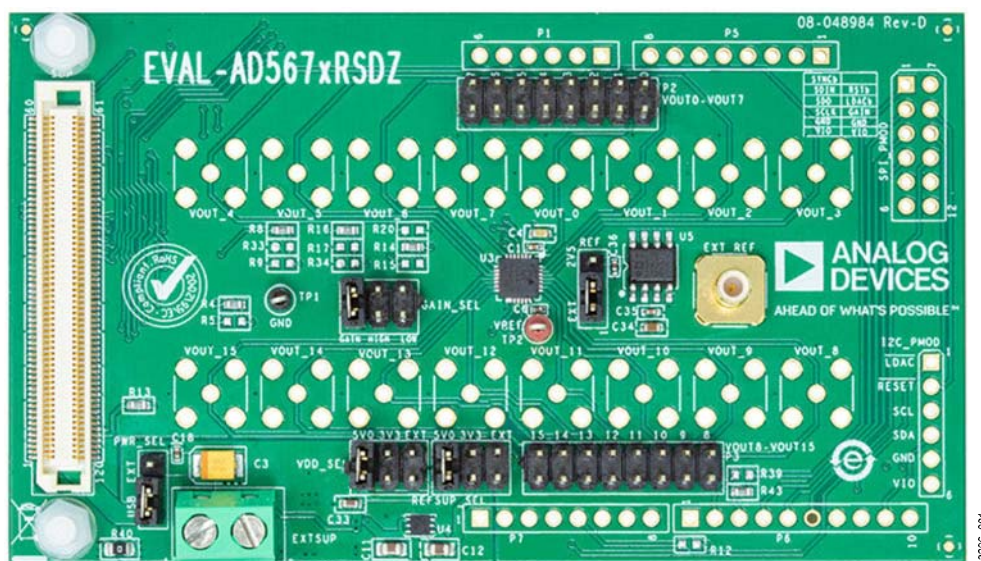

Figure 1.

TABLE OF CONTENTS

Features.....	1	On-Board Connectors.....	3
Evaluation Kit Contents.....	1	Evaluation Board Software Quick Start Procedures.....	4
Hardware Required.....	1	Installing the Software.....	4
Software Required.....	1	Initial Setup.....	4
General Description.....	1	Functional Block Diagram and Description.....	5
Evaluation Board Photograph.....	1	Memory Map.....	6
Revision History.....	2	Evaluation Board Schematics and Artwork.....	7
Evaluation Board Hardware.....	3	Ordering Information.....	12
Power Supplies.....	3	Bill of Materials.....	12
Link Options.....	3		

REVISION HISTORY

3/2020—Revision 0: Initial Version

EVALUATION BOARD HARDWARE

POWER SUPPLIES

The EVAL-AD5677RSDZ provides on-board 3.3 V and 5 V regulators powered through the USB supply or from an external source. If a different supply is required, or if the evaluation board is controlled through the PMOD connector, an external supply must be provided by the external supply voltage (EXTSUP) connector. See Table 1 for more information.

Each supply is decoupled to ground with 10 μ F tantalum and 0.1 μ F ceramic capacitors.

Table 1. Power Supply Connectors

Connector Label	External Voltage Supplies Description
EXTSUP, Pin 1	External analog power supply from 2.7 V to 5.5 V.
EXTSUP, Pin 2	Analog ground.
EXT_REF	External voltage reference. The AD5673R/AD5677R requires an external voltage reference.

LINK OPTIONS

A number of link options are incorporated on the EVAL-AD5679RSDZ and must be set for the required operating conditions before using the board. The functions of these link options are described in Table 2.

ON-BOARD CONNECTORS

Table 3 shows the connectors on the EVAL-AD5677RSDZ.

Table 2. Link Functions

Link	Description
PWR_SEL	This link selects the primary analog voltage source for the 3.3 V output and 5 V output for VDD_SEL. There are two options, as follows: The USB option selects the USB supply from Pin 5 of the 120-pin connector of the SDP-B board. The EXT option selects an EXTSUP connector. The voltage applied to EXTSUP must be between 2.7 V and 5.5 V.
VDD_SEL	This link selects the DAC analog voltage source. There are three options, as follows: The 5V0 option selects the on-board 5 V source from the LTC3536 . The 3V3 option selects the on-board 3.3 V source from the ADM7160 . The EXT option selects an EXTSUP connector. The voltage applied to EXTSUP must be between 2.7 V and 5.5 V.
GAIN_SEL	This link selects the gain setting for the DAC. There are three options, as follows: The gain option allows the ACE plug-in to control the gain setting of the device. The high option selects gain = 2. The low option selects gain = 1.
REFSUP_SEL	This link selects the voltage supply for the on-board voltage reference, ADR4525 . There are three options, as follows: The 5V0 option selects the on-board 5 V source from the LTC3536 . The 3V3 option selects the on-board 3.3 V source from the ADM7160 . The EXT option selects an EXTSUP connector. Voltage applied to EXTSUP must be between 2.7 V and 5.5 V.
REF	This link selects the external reference voltage for the DAC. The internal reference must be disabled first before using this feature (refer to the AD5677R data sheet). There are two options, as follows: The 2V5 option selects the on-board 2.5 V reference voltage from the ADR4525 . The EXT option selects an EXT_REF connector. The voltage applied to EXT_REF must be between 1 V and V _{DD} if gain = 1, and between 1 V and V _{DD} /2 if gain = 2.

Table 3. On-Board Connectors

Connector	Function
EXTSUP	External analog power supply from 2.7 V to 5.5 V.
EXT_REF	External voltage reference.
P2	DAC outputs from V _{OUT0} to V _{OUT7} .
P3	DAC outputs from V _{OUT8} to V _{OUT15} .

EVALUATION BOARD SOFTWARE QUICK START PROCEDURES

INSTALLING THE SOFTWARE

The EVAL-AD5677RSDZ uses the [ACE](#) evaluation software, which allows the evaluation and control of multiple evaluation systems.

The [ACE](#) installer installs the necessary [SDP-B](#) drivers and the Microsoft® .NET Framework 4 by default. The [ACE](#) software is available for download from the EVAL-AD5677RSDZ product page. This software must be installed before connecting the [SDP-B](#) board to the USB port of the PC to ensure that the [SDP-B](#) board is recognized and connected to the PC. For full instructions on how to install and use this software, see the [ACE](#) software page on the Analog Devices website.

After installation completes, the EVAL-AD5677RSDZ plug-in appears when the [ACE](#) software is opened.

INITIAL SETUP

To set up the evaluation board, take the following steps:

1. Connect the evaluation board to the [SDP-B](#) board. Then, connect the USB cable between the [SDP-B](#) board and the PC.
2. Run the [ACE](#) application. The EVAL-AD5677RSDZ plug-ins appear in the attached hardware section of the **Start** tab.
3. Double-click the board plug-in to open the board view shown in Figure 2.
4. Double-click the [AD5677R](#) chip to access the chip block diagram. This view provides a basic representation of the functionality of the board. The main functions of the board are labeled in Figure 3.



Figure 2. Board View of the EVAL-AD5677RSDZ

23296-002

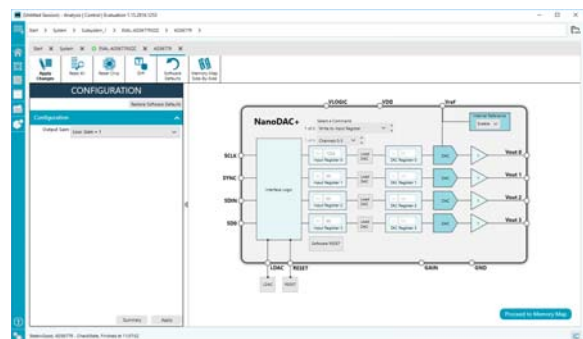

Figure 3. Chip Block Diagram of the AD5677R

23296-003

FUNCTIONAL BLOCK DIAGRAM AND DESCRIPTION

The EVAL-AD5677RSDZ software is organized to appear similar to the functional block diagram shown in the [AD5673R/AD5677R](#) data sheet, which simplifies correlating the functions on the EVAL-AD5677RSDZ with the description in the [AD5673R/AD5677R](#) data sheet.

For a full description of each block, register, and the corresponding settings, see the [AD5673R/AD5677R](#) data sheet.

Some of the blocks and their functions are described in this section as they pertain to the evaluation board. The full screen block diagram is shown in Figure 4. Table 4 describes the functionality of each block.

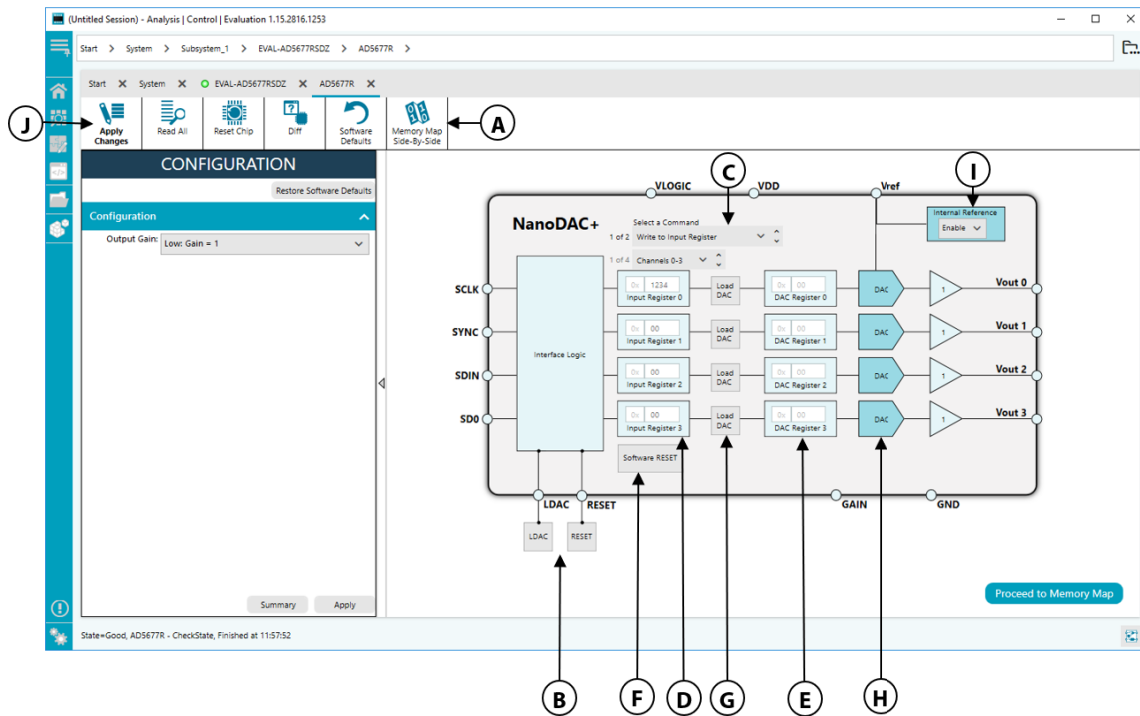

Figure 4. AD5677R Block Diagram with Labels

Table 4. Block Diagram Functions (See Figure 4)

Label	Button/Function Name	Function
A	CONFIGURATION wizard	Used to set the initial configuration for the board. Select the reference gain case from the Output Gain dropdown menu. A gain of 1 is the default. After setting up the initial configuration, click Apply to apply the values. These settings can be modified at any stage while evaluating the board.
B	LDAC and RESET (GPIO buttons)	Act as external GPIO pulses to the LDAC pin and RESET pin. The LDAC button pushes data from both input registers (Label D) to the DAC registers (Label E). The RESET button clears all data from input registers and DAC registers. These buttons are live and there is no need to click Apply Changes (Label J).
C	Select a Command	Command option dropdown menu selects how the data being transferred to the device affects the input registers and DAC registers. After a data value is entered in an input register (Label D), this menu determines if the data is transferred to the input register only, or to the channel input register (Label D) and the channel DAC register (Label E).
D	Input Register 0 through Input Register 15	16-bit data word to be transferred to the device. Click Apply Changes (Label J) to transfer this 16-bit data word to the device.
E	DAC Register 0 through DAC Register 15	Displays the value that is currently present in the DAC register on the device. Update the DAC registers by selecting the appropriate command option or by toggling LDAC (Label B). DAC Register contents may vary depending on the device, refer to the AD5673R/AD5677R data sheet.
F	Software RESET	Returns the evaluation board and software to default values. This button is live. Therefore, there is no need to click Apply Changes .
G	Load DAC	Users can individually control which channel loads the values from the input registers to the DAC register.
H	DAC	DAC configuration options provide access to individual channel configuration options such as power-down options and hardware LDAC mask enable and disable settings.

Label	Button/Function Name	Function
I	Internal Reference	Select Enable from this setting to enable the on-chip reference for the evaluation board. If Disable is selected, an external reference must be applied. This control is only available on the AD5677R/AD5673R .
J	Apply Changes	Applies all modified values to the device. Note that if an evaluation board is not connected, values entered in the input registers are not transferred to the DAC registers.

MEMORY MAP

All registers are fully accessible from the **AD5677R Memory Map** tab, shown in Figure 5. This tab allows registers to be edited at the bit level. The bits shaded in dark gray are read only bits and cannot be accessed from the **ACE** software. All other bits are toggled.

Clicking the **Apply Changes** button transfers data to the device. All changes made in the memory map tab correspond to the block diagram. For example, if the internal register bit is enabled, it displays as enabled on the block diagram. Any bits or registers shown in bold in the memory map tab are modified values that have not been transferred to the evaluation board (see Figure 6). Click **Apply Changes** to transfer the data to the evaluation board.

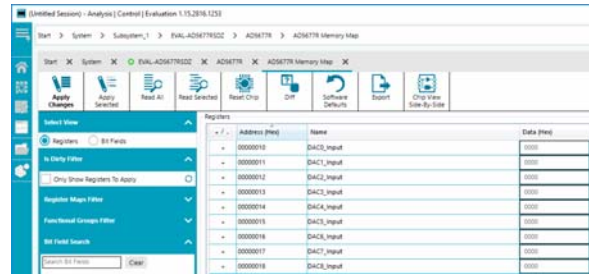

Figure 5. AD5677R Memory Map Tab

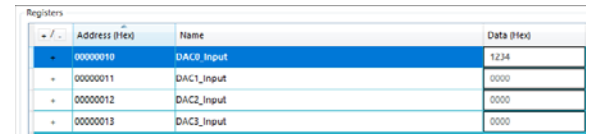

Figure 6. AD5677R Memory Map with Unapplied Changes in the DAC0_input Register

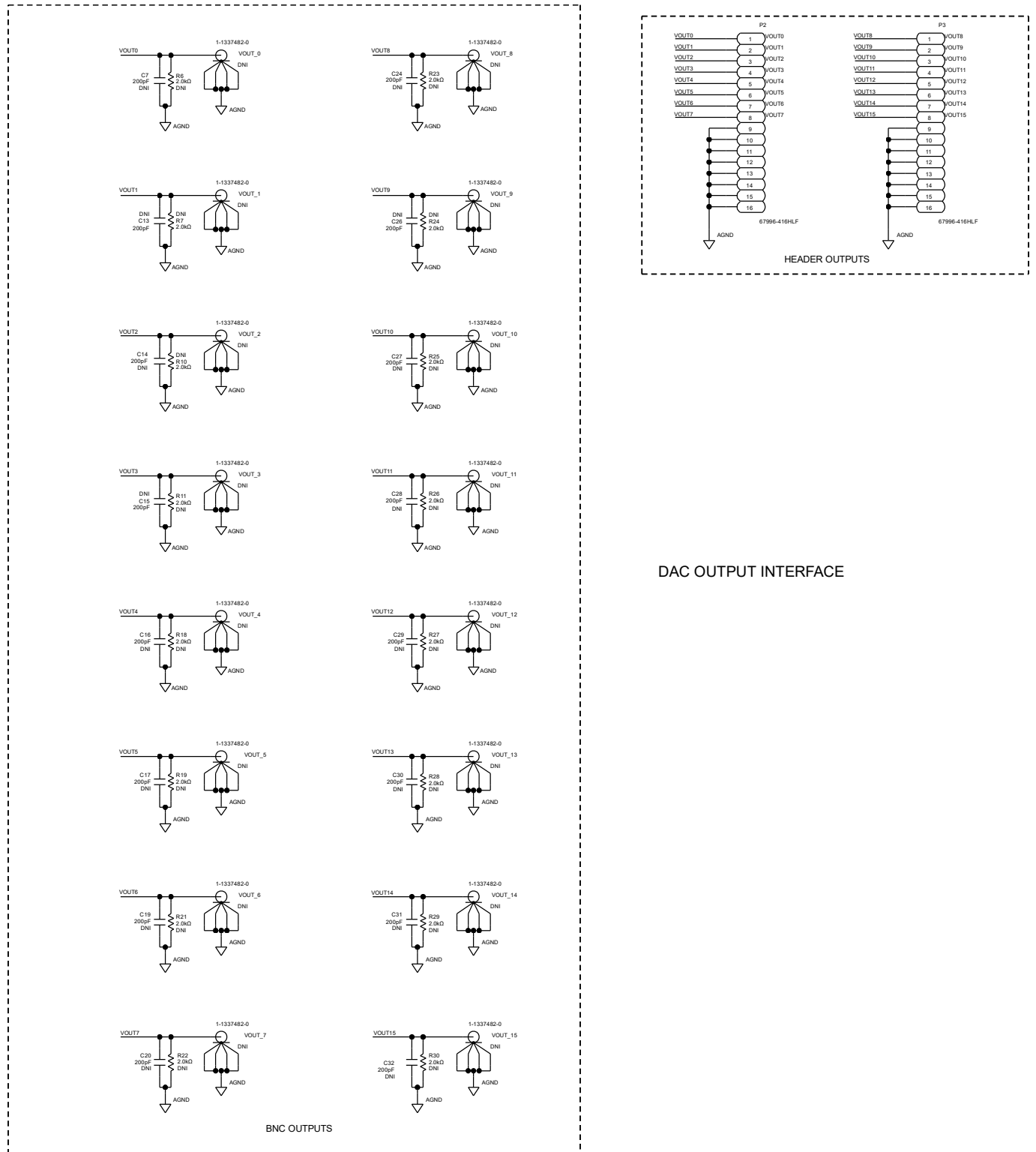

Figure 9. EVAL-AD5677RSDZ Schematic, Output Connectors

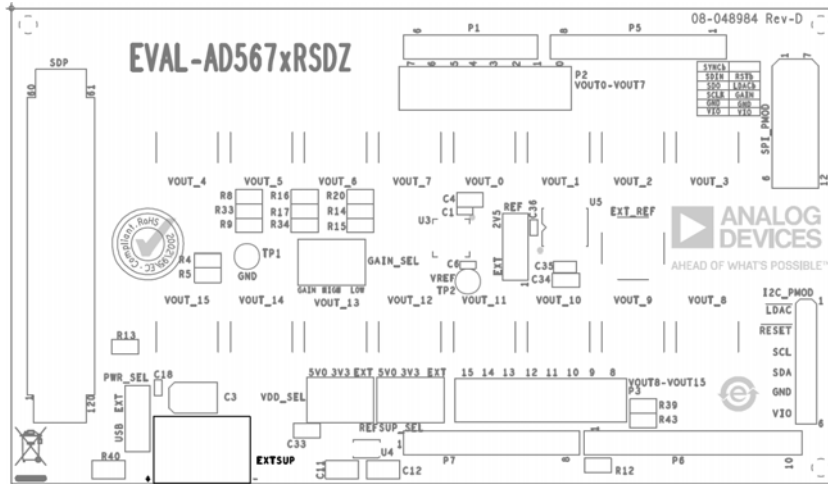

Figure 10. EVAL-AD5677RSDZ Top Side Component Placement

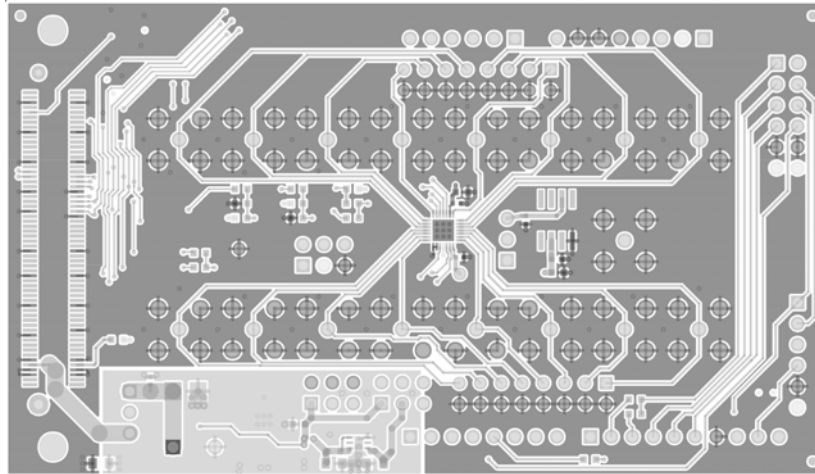

Figure 11. EVAL-AD5677RSDZ Top Side Routing

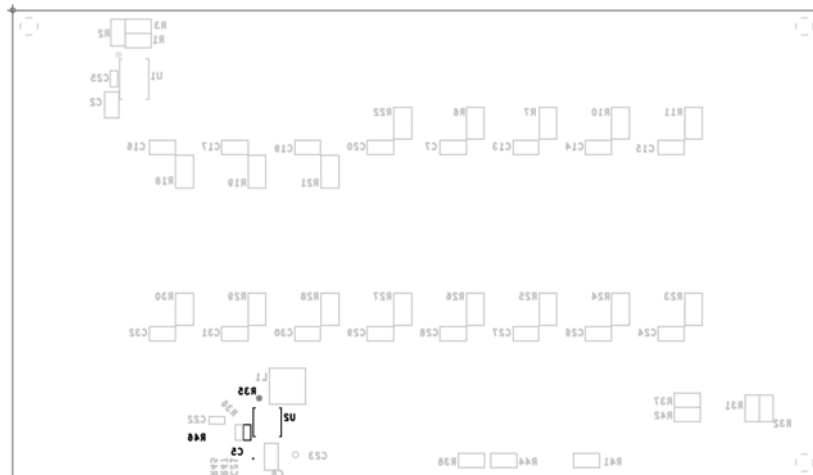

Figure 12. EVAL-AD5677RSDZ Bottom Side Component Placement

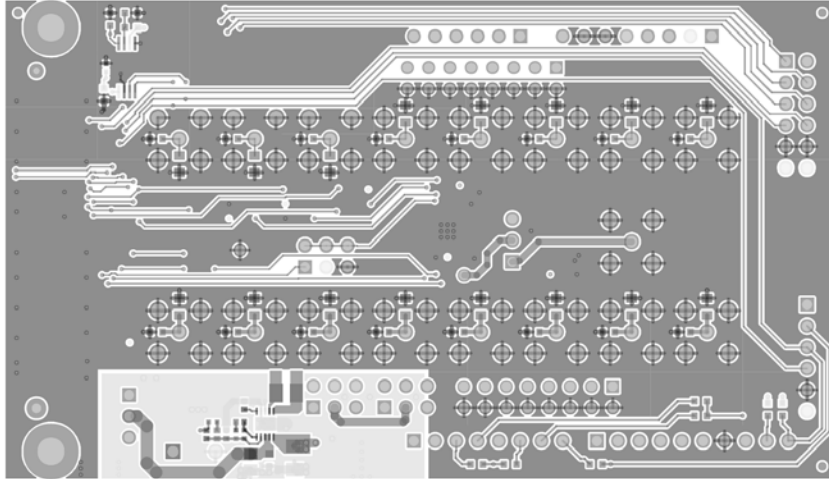

Figure 13. EVAL-AD5677RSDZ Bottom Side Routing

ORDERING INFORMATION

BILL OF MATERIALS

Table 5.

Qty	Reference Designator	Description	Supplier/Part Number ^{1,2}
4	C1, C6, C18, C25	Ceramic capacitors, 0.1 μ F, 16 V, X7R, 0402	GRM155R71C104KA88D
2	C11, C12	Ceramic capacitors, 4.7 μ F, 10 V, X7R, 0805	C2012X7R1A475M085AC
2	C2, C4	Ceramic capacitors, 10 μ F, 10 V, X5R, 0603	GRM188R61A106KE69D
1	C21	Ceramic capacitor, 68 pF, 50 V, NP0, 0402	GCM1555C1H680JA16D
1	C22	Ceramic capacitor, 15 pF, 50 V, C0G, 0402	CGA2B2COG1H150J050BA
1	C23	Ceramic capacitor, 22 μ F, 25 V, X5R, 1206	CL31A226KAHNNNE
1	C3	Tantalum capacitor, 10 μ F, 16 V, 1411	TAJB106K016RNJ
2	C8, C33	Ceramic capacitors, 1 μ F, 10 V, X7R, 0603	CL10B105KP8NNNC
1	C34	Ceramic capacitors, 10 μ F, 25 V, X5R, 0603	GRT188R61E106ME13D
1	C35	Ceramic capacitors, 0.1 μ F, 25 V, X5R, 0402	TMK105BJ104KV-F
1	C36	Ceramic capacitors, 1 μ F, 25 V, X5R, 0402	GRM155R61E105MA12D
1	C5	Ceramic capacitor, 10 μ F, 25 V, X5R, 0805	GRM21BR61E106KA73L
1	EXTSUP	Terminal block, 5.08 mm pitch	OSTTC022162
1	L1	Inductor, 4.7 μ H, 5 A, 57.4 m Ω direct current resistance (DCR)	XFL4020-472MEB
1	PWR_SEL	3-pin male header, 2.54 mm pitch	M20-9990345
3	GAIN_SEL, REFSUP_SEL, VDD_SEL	6-pin male headers, 2.54 mm pitch	TSW-103-08-G-D
2	P2, P3	16-pin male headers, 2.54 mm pitch	67996-416HLF
1	R13	Resistor, SMD, 0 Ω , 1%, 1/10 W, 0603, thick film	CRCW0603000ZRT1
8	R4, R8, R14, R16, R41, R42, R43, R44	Resistors, SMD, 0 Ω , 1/16 W, 0603, thick film	MC0603WG00000T5E-TC
2	R2, R3	Resistors, SMD, 100 k Ω , 5%, 1/10 W, 0603, thick film	RC0603JR-07100KL
1	R35	Resistor, SMD, 100 k Ω , 1%, 1/5 W, 0402, thick film	ERJ-PA2F1003X
2	R36, R47	Resistors, SMD, 150 k Ω , 1%, 1/10 W, 0402, thick film	ERJ-2RKF1503X
1	R40	Resistor, SMD, 0 Ω , 1/10 W, 0805, thick film	MC 0.1W 0805 0R
1	R45	Resistor, SMD, 21.5 k Ω , 1%, 1/10 W, 0402, thick film	ERJ-2RKF2152X
1	R46	Resistor, SMD, 1.1 M Ω , 1%, 1/16 W, 0402, thick film	AC0402FR-071M1L
1	REF	3-pin male header, 2.54 mm pitch	YMC03SAAN
1	SDP	SDP connector	FX8-120S-SV(21)
1	TP1	Test point, black	20-2137
1	TP2	Test point, red	20-313137
1	EXT_REF	Subminiature Version B (SMB) connector	1-1337482-0
1	U1	32 k Ω , I ² C electronically erasable programmable read-only memory (EEPROM)	24LC32A-I/ST
1	U2	1 A low noise, buck-boost dc-to-dc converter	LTC3536EDD#PBF
1	U3	16-channel, 16-Bit, <i>nano</i> DAC+	AD5677RBCPZ-1
1	U4	Ultralow noise, 200 mA linear regulator	ADM7160ACPZN3.3-R7
1	U5	Ultralow noise, high accuracy voltage reference	ADR4525BRZ

¹ FEC refers to Farnell Electronic Component Distributors.² Generic indicates that any device with the specified value, size, and rating can be used.

NOTES

I²C refers to a communications protocol originally developed by Philips Semiconductors (now NXP Semiconductors).



ESD Caution

ESD (electrostatic discharge) sensitive device. Charged devices and circuit boards can discharge without detection. Although this product features patented or proprietary protection circuitry, damage may occur on devices subjected to high energy ESD. Therefore, proper ESD precautions should be taken to avoid performance degradation or loss of functionality.

Legal Terms and Conditions

By using the evaluation board discussed herein (together with any tools, components documentation or support materials, the "Evaluation Board"), you are agreeing to be bound by the terms and conditions set forth below ("Agreement") unless you have purchased the Evaluation Board, in which case the Analog Devices Standard Terms and Conditions of Sale shall govern. Do not use the Evaluation Board until you have read and agreed to the Agreement. Your use of the Evaluation Board shall signify your acceptance of the Agreement. This Agreement is made by and between you ("Customer") and Analog Devices, Inc. ("ADI"), with its principal place of business at One Technology Way, Norwood, MA 02062, USA. Subject to the terms and conditions of the Agreement, ADI hereby grants to Customer a free, limited, personal, temporary, non-exclusive, non-sublicensable, non-transferable license to use the Evaluation Board FOR EVALUATION PURPOSES ONLY. Customer understands and agrees that the Evaluation Board is provided for the sole and exclusive purpose referenced above, and agrees not to use the Evaluation Board for any other purpose. Furthermore, the license granted is expressly made subject to the following additional limitations: Customer shall not (i) rent, lease, display, sell, transfer, assign, sublicense, or distribute the Evaluation Board; and (ii) permit any Third Party to access the Evaluation Board. As used herein, the term "Third Party" includes any entity other than ADI, Customer, their employees, affiliates and in-house consultants. The Evaluation Board is NOT sold to Customer; all rights not expressly granted herein, including ownership of the Evaluation Board, are reserved by ADI. CONFIDENTIALITY. This Agreement and the Evaluation Board shall all be considered the confidential and proprietary information of ADI. Customer may not disclose or transfer any portion of the Evaluation Board to any other party for any reason. Upon discontinuation of use of the Evaluation Board or termination of this Agreement, Customer agrees to promptly return the Evaluation Board to ADI. ADDITIONAL RESTRICTIONS. Customer may not disassemble, decompile or reverse engineer chips on the Evaluation Board. Customer shall inform ADI of any occurred damages or any modifications or alterations it makes to the Evaluation Board, including but not limited to soldering or any other activity that affects the material content of the Evaluation Board. Modifications to the Evaluation Board must comply with applicable law, including but not limited to the RoHS Directive. TERMINATION. ADI may terminate this Agreement at any time upon giving written notice to Customer. Customer agrees to return to ADI the Evaluation Board at that time. LIMITATION OF LIABILITY. THE EVALUATION BOARD PROVIDED HEREUNDER IS PROVIDED "AS IS" AND ADI MAKES NO WARRANTIES OR REPRESENTATIONS OF ANY KIND WITH RESPECT TO IT. ADI SPECIFICALLY DISCLAIMS ANY REPRESENTATIONS, ENDORSEMENTS, GUARANTEES, OR WARRANTIES, EXPRESS OR IMPLIED, RELATED TO THE EVALUATION BOARD INCLUDING, BUT NOT LIMITED TO, THE IMPLIED WARRANTY OF MERCHANTABILITY, TITLE, FITNESS FOR A PARTICULAR PURPOSE OR NONINFRINGEMENT OF INTELLECTUAL PROPERTY RIGHTS. IN NO EVENT WILL ADI AND ITS LICENSORS BE LIABLE FOR ANY INCIDENTAL, SPECIAL, INDIRECT, OR CONSEQUENTIAL DAMAGES RESULTING FROM CUSTOMER'S POSSESSION OR USE OF THE EVALUATION BOARD, INCLUDING BUT NOT LIMITED TO LOST PROFITS, DELAY COSTS, LABOR COSTS OR LOSS OF GOODWILL. ADI'S TOTAL LIABILITY FROM ANY AND ALL CAUSES SHALL BE LIMITED TO THE AMOUNT OF ONE HUNDRED US DOLLARS (\$100.00). EXPORT. Customer agrees that it will not directly or indirectly export the Evaluation Board to another country, and that it will comply with all applicable United States federal laws and regulations relating to exports. GOVERNING LAW. This Agreement shall be governed by and construed in accordance with the substantive laws of the Commonwealth of Massachusetts (excluding conflict of law rules). Any legal action regarding this Agreement will be heard in the state or federal courts having jurisdiction in Suffolk County, Massachusetts, and Customer hereby submits to the personal jurisdiction and venue of such courts. The United Nations Convention on Contracts for the International Sale of Goods shall not apply to this Agreement and is expressly disclaimed.