

DKSV134

Normally closed, direct lift, 2-way solenoid valve with brass body and 1/2" connections

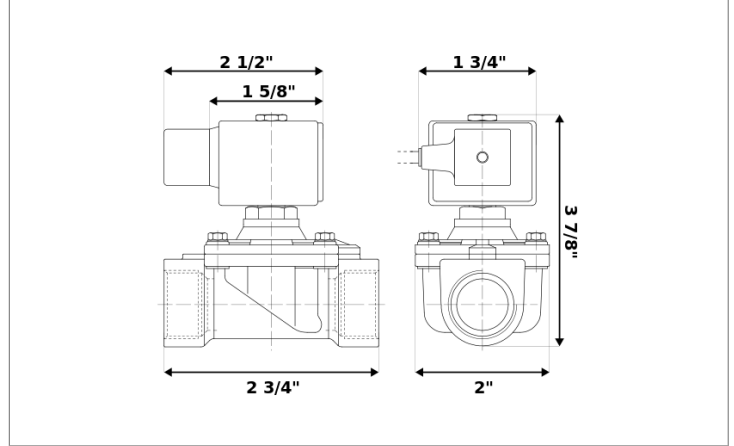

Valve	
Pipe size:	1/2" NPT
Pressure:	0-200 psi
Flow coefficient:	2.8 Cv
Media temperature:	15-195 °F
Ambient temperature:	-5-140 °F
Suggested usage:	Air, inert gas, water
Operation:	2-way, normally closed solenoid valve
Mechanism:	Direct lift
Manual override:	No
Pipe gender:	Female
Orifice size:	5/8"
Vacuum rating:	0.001 Torr

Electrical	
Power:	240 V ac
Coil wattage:	8 W
Wire connection:	6 ft. power cord
Inrush:	25.0 VA
Holding:	14.5 VA
Consumption:	0.03 A
Tolerances:	+10% -15%
Coil inner diameter:	1/2"
Coil molding:	Polyethylene (PET)
Coil rating:	-5-355 °F (Class H)
Duty cycle:	Continuous, 100% ED
Enclosure:	NEMA 4, IP65

Materials	
Body:	Brass
Seal:	Buna-N/polyamide rubber (NBR+PA)
Orifice:	Brass
Armature tube:	Stainless steel 300
Fixed core:	Stainless steel 400
Plunger:	Stainless steel 400
Spring:	Stainless steel 300
Shading ring:	Copper

Spare parts		
ARMATURE TUBE	REPAIR KIT	COIL/CONNECTOR
AT-H091	RK-H0Y2	C-B52
		
<ul style="list-style-type: none"> • Armature tube 	<ul style="list-style-type: none"> • O-ring • Plunger and diaphragm assembly 	<ul style="list-style-type: none"> • 240 V ac electrical coil • 6 ft. power cord