

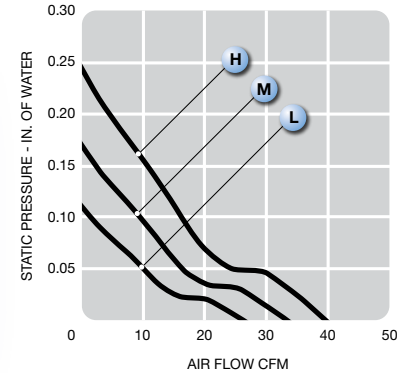

LPH80B99 series

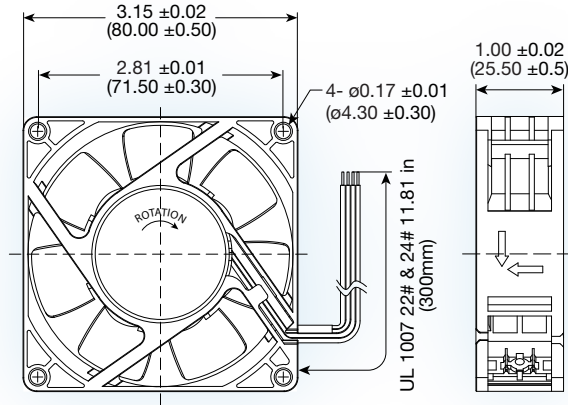

(80 x 80 x 25 mm)
3.15 x 3.15 x 1.00 inches

Operating voltage: 85 to 265 VAC

Construction: plastic frame and impeller

Bearing option: ball bearing

Motor: electronically commutated

Air flow: exhaust over struts

Connection: lead wire UL1007 24AWG
or terminal

Protection/IP Level: auto restart/ IP54

Options: tachometer, PWM,
environmental protection

Model No.	Rated Voltage V	Freq. HZ	Input Power W	Rated Cur. A	Speed RPM	Air Volume		Max. Static Pressure (H ₂ O)		Sound Noise dB A	Weight g
						M ³ /Min.	CFM	MM	INCH		
LPH80B99-L*	100-240	50/60	1.6	0.04	2500	0.73	26	2.8	0.11	24	95
LPH80B99-M*	100-240	50/60	2.4	0.05	3000	0.90	32	4.3	0.17	27	95
LPH80B99-H	100-240	50/60	4.5	0.06	3500	1.09	39	6.4	0.25	31	95

*This speed not UL recognized