

PROJECT NO. SIMILAR ITEM EDP NO. ENG. NO. SD 35272-0310

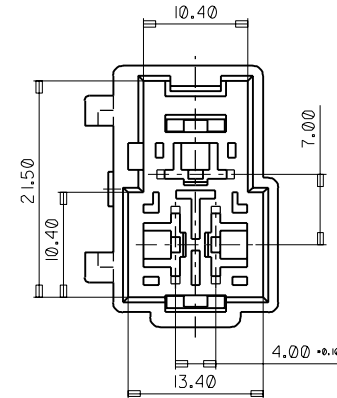
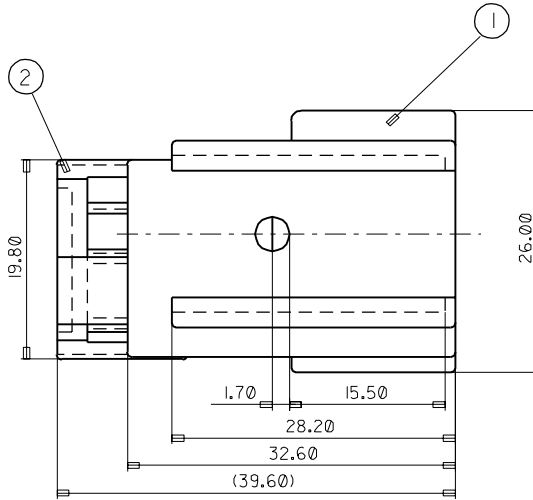
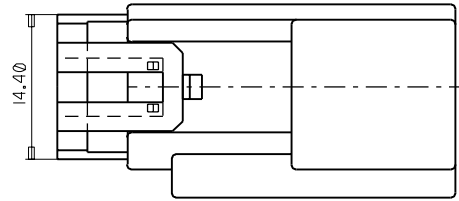
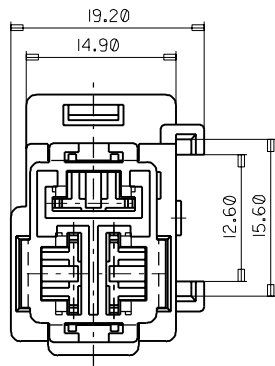

	P/N.O.	PART NAME	MATERIAL
①	35272-0390	POWERMATE MALE HSG 3P	PBT
②	35273-0380	POWERMATE MALE TPA 3P	PBT

\* APPLICABLE TERMINAL : 35725-30\*\*,18\*\*,19\*\*

			MATERIAL SEE TABLE		MOLEX-KOREA CO.,LTD.	
			GENERAL TOLERANCE DIMENSION : *0.20		DRAWN BY 961120 J.K.OH	
			ANGLE :		CHK'D BY	
			DIMENSION CLASSIFICATION		APP'D BY	
			▽ : CRITICAL ▼ : MAJOR		SCALE 2 : 1	
			( ) : REFERENCE		TITLE :	
A NEW RELEASE			KOR1997-0153	971119	POWERMATE MALE ASSY 3P	
LTR REVISION RECORD			ECN	DATE	SHEET 1/1	
REVISE ONLY ON CAD SYSTEM					ENG. NO. SD 35272-0310	
					REV A	