

FEATURES

- Allows Safe Board Insertion and Removal from a Live, CompactPCI™ Bus
- Controls –12V, 3.3V, 5V and 12V Supplies
- Adjustable Foldback Current Limit with Circuit Breaker
- Dual-Level Circuit Breakers Protect 5V and 3.3V Supplies from Overcurrent and Short-Circuit Faults
- LOCAL_PCI_RST# Logic On-Chip
- PRECHARGE Output Biases I/O Pins During Card Insertion and Extraction
- Adjustable Supply Voltage Power-Up Rate

APPLICATIONS

- Hot Board Insertion into CompactPCI Bus

DESCRIPTION

The LTC[®]1644 is a Hot Swap™ controller that allows a board to be safely inserted and removed from a CompactPCI bus slot. External N-channel transistors control the 3.3V/5V supplies, while on-chip switches control the –12V and 12V supplies. The 3.3V and 5V supplies can be ramped up at a programmable rate. Electronic circuit breakers protect all four supplies against overcurrent faults. The PWRGD output indicates when all of the supply voltages are within tolerance. The OFF/ON pin is used to cycle the board power or reset the circuit breaker. The PRECHARGE output can be used to bias the bus I/O pins during card insertion and extraction. PCI_RST# is combined on-chip with HEALTHY# in order to generate LOCAL_PCI_RST#.

LTC, LTC and LT are registered trademarks of Linear Technology Corporation. Hot Swap is a trademark of Linear Technology Corporation. CompactPCI is a trademark of the PCI Industrial Computer Manufacturers Group.

TYPICAL APPLICATION

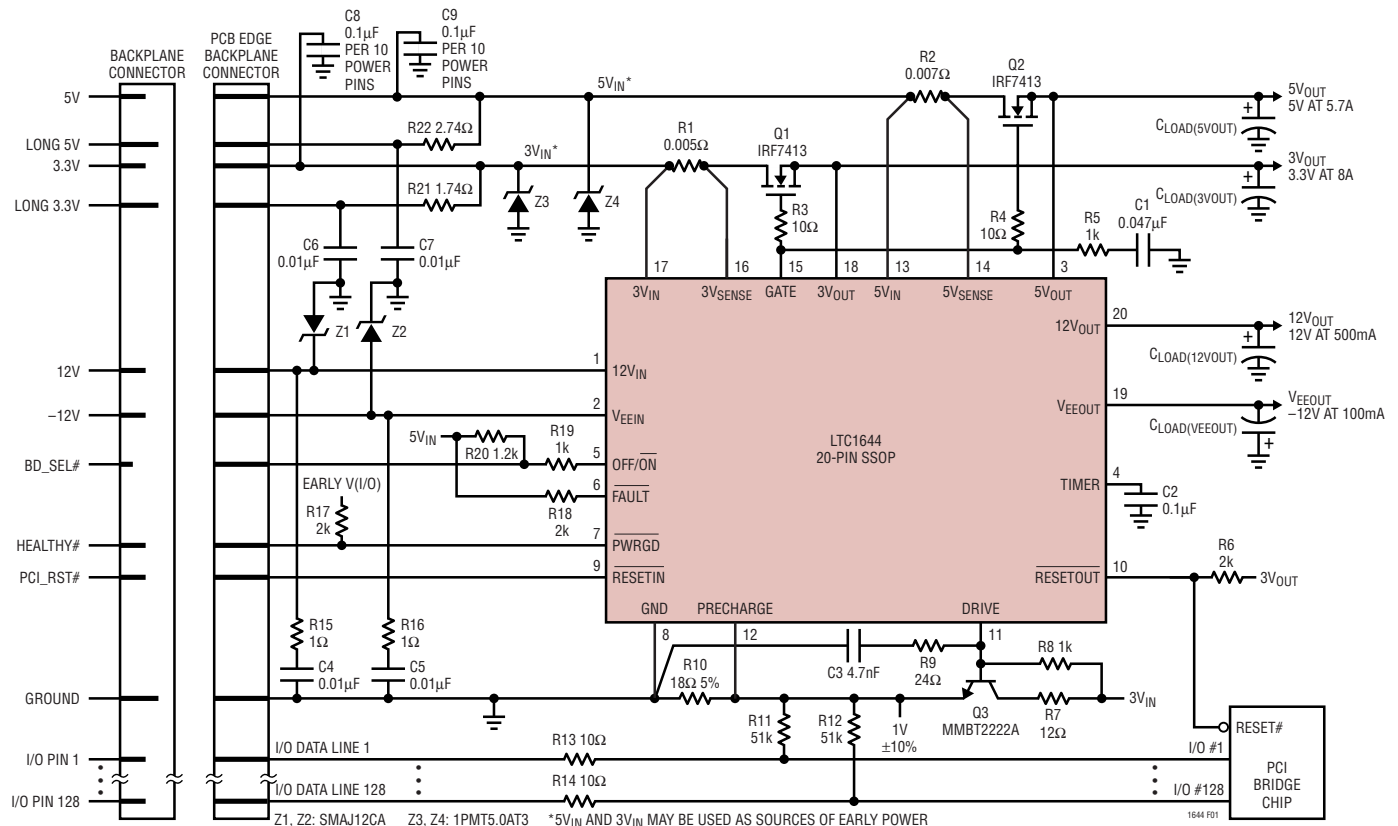

Figure 1

ABSOLUTE MAXIMUM RATINGS

(Note 1)

Supply Voltages

12V_{IN} 13.2V

V_{EEIN} -14V

Input Voltages (Pins 5, 9) -0.3V to 13.5V

Output Voltages (Pins 6, 7, 10) -0.3V to 13.5V

Analog Voltages and Currents

Pins 3, 11 to 14, 16 to 18 -0.3V to 13.5V

Pins 4, 15 -0.3V to (12V_{IN} + 0.3V)

V_{EEOUT} -14V to 0.3V

12V_{OUT} -0.3V to 13.2V

Operating Temperature Range

LTC1644C 0°C to 70°C

LTC1644I -40°C to 85°C

Storage Temperature Range -65°C to 150°C

Lead Temperature (Soldering, 10 sec) 300°C

PACKAGE/ORDER INFORMATION

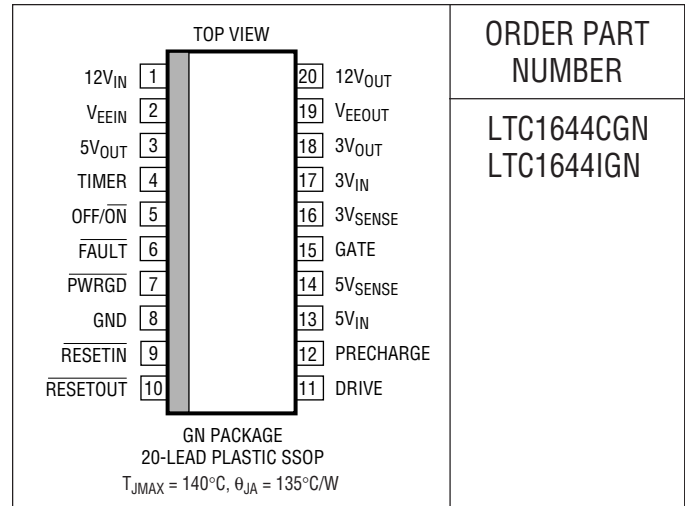

ORDER PART NUMBER

LTC1644CGN
LTC1644IGN

Consult LTC Marketing for parts specified with wider operating temperature ranges.

ELECTRICAL CHARACTERISTICS

The ● denotes the specifications which apply over the full operating temperature range, otherwise specifications are at T_A = 25°C.

V_{12VIN} = 12V, V_{EEIN} = -12V, V_{3VIN} = 3.3V, V_{5VIN} = 5V unless otherwise noted.

SYMBOL	PARAMETER	CONDITIONS	MIN	TYP	MAX	UNITS	
I _{DD}	V _{12VIN} Supply Current	OFF/ON = 0V	●	3	8	mA	
V _{LKO}	Undervoltage Lockout	12V _{IN} , Ramping Down	●	6.00	8.30	10.80	V
		3V _{IN} , 5V _{IN} , Ramping Down	●	2.25	2.48	2.75	V
V _{FB}	Foldback Current Limit Voltage	V _{FB} = (V _{5VIN} - V _{5VSENSE}), V _{5VOUT} = 0V, TIMER = 0V	●	8	12	15	mV
		V _{FB} = (V _{5VIN} - V _{5VSENSE}), V _{5VOUT} = 3V, TIMER = 0V	●	40	51	70	mV
		V _{FB} = (V _{3VIN} - V _{3VSENSE}), V _{3VOUT} = 0V, TIMER = 0V	●	8	12	15	mV
		V _{FB} = (V _{3VIN} - V _{3VSENSE}), V _{3VOUT} = 2V, TIMER = 0V	●	40	51	70	mV
V _{CB}	Circuit Breaker Trip Voltage	V _{CB} = (V _{5VIN} - V _{5VSENSE}), TIMER = FLOAT	●	40	55	70	mV
		V _{CB} = (V _{3VIN} - V _{3VSENSE}), TIMER = FLOAT	●	40	55	70	mV
t _{OC}	Overcurrent Fault Response Time	(V _{5VIN} - V _{5VSENSE}) = 100mV, TIMER = FLOAT	●	30	45	60	μs
		(V _{3VIN} - V _{3VSENSE}) = 100mV, TIMER = FLOAT	●	30	45	60	μs
t _{SC}	Short-Circuit Response Time	(V _{5VIN} - V _{5VSENSE}) = 200mV, TIMER = FLOAT	●		0.1	1.0	μs
		(V _{3VIN} - V _{3VSENSE}) = 200mV, TIMER = FLOAT	●		0.1	1.0	μs
I _{CP}	GATE Pin Output Current	OFF/ON = 0V, V _{GATE} = 0V, TIMER = 0V	●	-20	-65	-100	μA
		V _{GATE} = 5V, OFF/ON = 4V		100	225	300	μA
		OFF/ON = 0V, V _{GATE} = 2V, TIMER = FLOAT, FAULT = 0V	●	3	10	20	mA
ΔV _{GATE}	External Gate Voltage	ΔV _{GATE} = (V _{12VIN} - V _{GATE}), I _{GATE} = -1μA	●		50	200	mV
V _{DROP}	Internal Switch Voltage Drop	V _{DROP} = (V _{12VIN} - V _{12VOUT}), I = 500mA	●		200	600	mV
		V _{DROP} = (V _{EEOUT} - V _{EEIN}), I _{EE} = 100mA	●		110	250	mV
I _{CL}	Current Foldback	12V _{IN} = 12V, 12V _{OUT} = 0V, TIMER = 0V	●	-50	-360	-600	mA
		12V _{IN} = 12V, 12V _{OUT} = 10V, TIMER = 0V	●	-525	-840	-1500	mA
		V _{EEIN} = -12V, V _{EEOUT} = 0V, TIMER = 0V	●	20	100	300	mA
		V _{EEIN} = -12V, V _{EEOUT} = -10V, TIMER = 0V	●	200	320	650	mA
T _{TS}	Thermal Shutdown Temperature			130			°C

ELECTRICAL CHARACTERISTICS

The ● denotes the specifications which apply over the full operating temperature range, otherwise specifications are at $T_A = 25^\circ\text{C}$.
 $V_{12VIN} = 12\text{V}$, $V_{EEIN} = -12\text{V}$, $V_{3VIN} = 3.3\text{V}$, $V_{5VIN} = 5\text{V}$ unless otherwise noted.

SYMBOL	PARAMETER	CONDITIONS	MIN	TYP	MAX	UNITS	
V_{TH}	Power Good Threshold Voltage	$12V_{OUT}$	●	10.8	11.1	11.4	V
		V_{EEOUT}	●	-10.4	-10.5	-11.1	V
		$3V_{OUT}$	●	2.8	2.9	3.0	V
		$5V_{OUT}$	●	4.50	4.62	4.75	V
V_{3VONLY}	3V Only Window Voltage	$V_{3VONLY} = V_{5VIN} - V_{3VIN} $, $V_{5VOUT} = V_{3VOUT} = 3\text{V}$	●	50	107	200	mV
$V_{NOVEEIN}$	No V_{EEIN} Threshold Voltage	V_{EEIN}	●	-4	-4.6	-6.3	V
V_{IL}	Input Low Voltage	$\text{OFF}/\overline{\text{ON}}$, $\overline{\text{RESETIN}}$, $\overline{\text{FAULT}}$	●			0.8	V
V_{IH}	Input High Voltage	$\text{OFF}/\overline{\text{ON}}$, $\overline{\text{RESETIN}}$, $\overline{\text{FAULT}}$	●	2			V
I_{IN}	OFF/ $\overline{\text{ON}}$, $\overline{\text{RESETIN}}$ Input Current	OFF/ $\overline{\text{ON}}$, $\overline{\text{RESETIN}} = 0\text{V}$	●		± 0.08	± 10	μA
		OFF/ $\overline{\text{ON}}$, $\overline{\text{RESETIN}} = 12V_{IN}$	●		± 0.08	± 10	μA
	RESETOUT, $\overline{\text{FAULT}}$ Output Current	RESETOUT, $\overline{\text{FAULT}} = 5\text{V}$, OFF/ $\overline{\text{ON}} = 0\text{V}$, $\overline{\text{RESETIN}} = 3.3\text{V}$	●		± 0.08	± 10	μA
	PWRGD Output Current	PWRGD = 5V, OFF/ $\overline{\text{ON}} = 4\text{V}$	●		± 0.08	± 10	μA
	$5V_{SENSE}$ Input Current	$5V_{SENSE} = 5\text{V}$, $5V_{OUT} = 0\text{V}$	●		55	100	μA
	$3V_{SENSE}$ Input Current	$3V_{SENSE} = 3.3\text{V}$, $3V_{OUT} = 0\text{V}$	●		55	100	μA
	$5V_{IN}$ Input Current	$5V_{IN} = 5\text{V}$, $\text{TIMER} = 0\text{V}$	●		1	1.5	mA
	$3V_{IN}$ Input Current	$3V_{IN} = 3.3\text{V}$, $\text{TIMER} = \text{FLOAT}$	●		490	625	μA
		$3V_{IN} = 3.3\text{V}$, $\text{TIMER} = 0\text{V}$	●		380	550	μA
$5V_{OUT}$ Input Current	$5V_{OUT} = 5\text{V}$, OFF/ $\overline{\text{ON}} = 0\text{V}$, $\text{TIMER} = 0\text{V}$	●		102	400	μA	
$3V_{OUT}$ Input Current	$3V_{OUT} = 3.3\text{V}$, OFF/ $\overline{\text{ON}} = 0\text{V}$, $\text{TIMER} = 0\text{V}$	●		161	500	μA	
I_{TIMER}	TIMER Pin Current	OFF/ $\overline{\text{ON}} = 0\text{V}$, $V_{TIMER} = 0\text{V}$	●	-15	-21	-27	μA
		$V_{TIMER} = 5\text{V}$, OFF/ $\overline{\text{ON}} = 4\text{V}$	●	30	45	70	mA
V_{TIMER}	TIMER Threshold Voltages	$(V_{12VIN} - V_{TIMER})$, $\overline{\text{FAULT}} = 0\text{V}$	●	0.5	1	1.3	V
R_{DIS}	$5V_{OUT}$ Discharge Impedance	OFF/ $\overline{\text{ON}} = 4\text{V}$	●		45	100	Ω
	$3V_{OUT}$ Discharge Impedance	OFF/ $\overline{\text{ON}} = 4\text{V}$	●		60	100	Ω
	$12V_{OUT}$ Discharge Impedance	OFF/ $\overline{\text{ON}} = 4\text{V}$	●		430	1000	Ω
	V_{EEOUT} Discharge Impedance	OFF/ $\overline{\text{ON}} = 4\text{V}$	●		625	1000	Ω
V_{OL}	Output Low Voltage	PWRGD, RESETOUT, $\overline{\text{FAULT}}$, $I = 3\text{mA}$	●			0.4	V
V_{PXG}	PRECHARGE Reference Voltage	$V_{5VIN} = 5\text{V}$	●	0.95	1.00	1.05	V
		$V_{5VIN} = V_{3VIN} = 3.3\text{V}$	●	0.95	1.00	1.05	V

Note 1: Absolute Maximum Ratings are those values beyond which the life of a device may be impaired.

Note 2: All currents into device pins are positive; all currents out of device pins are negative. All voltages are referenced to ground unless otherwise specified.

TYPICAL PERFORMANCE CHARACTERISTICS

3.3V and 5V Current Foldback Profile

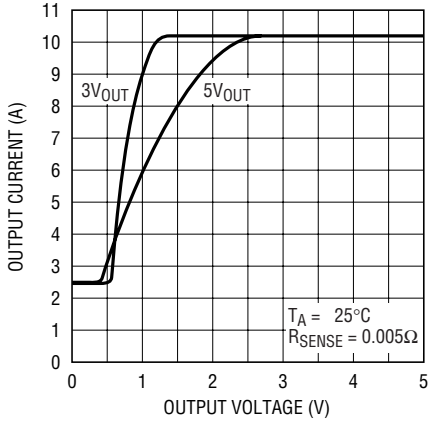

12V Output Current

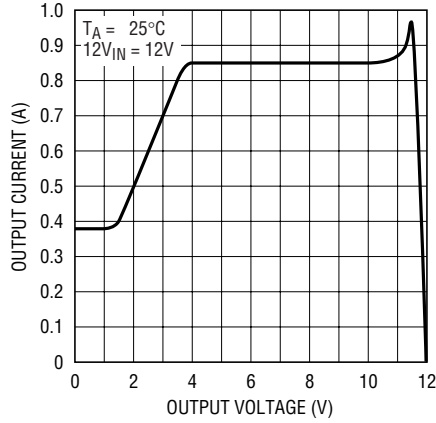

-12V Output Current

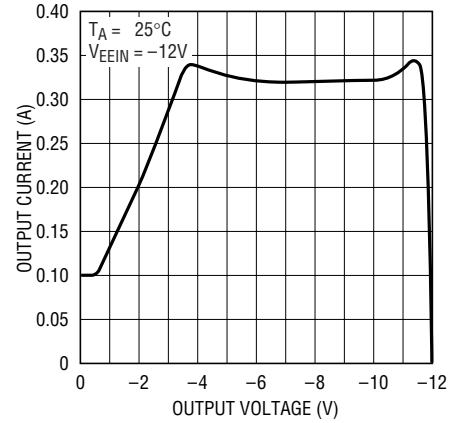

12VIN Supply Current vs Temperature

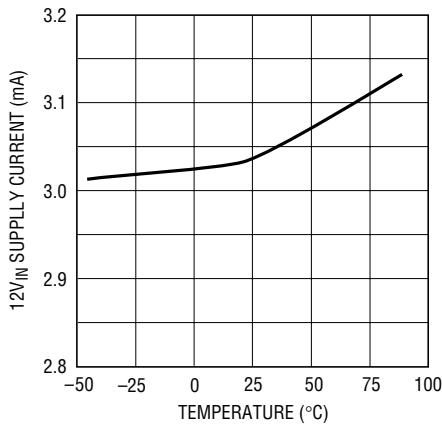

12VIN Undervoltage Lockout vs Temperature

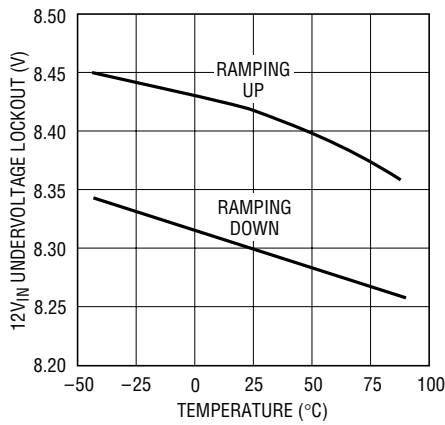

5VIN UVLO Threshold Voltage vs Temperature

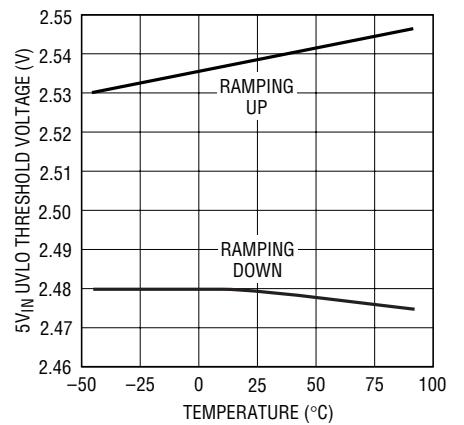

3VIN UVLO Threshold Voltage vs Temperature

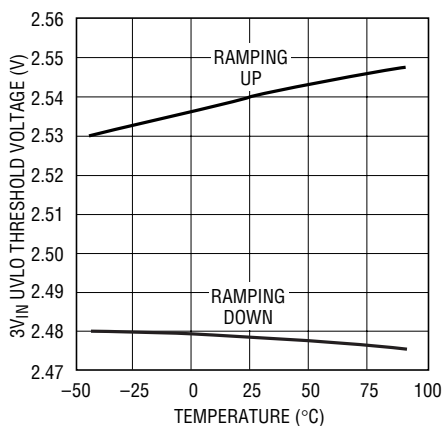

5V Foldback Current Limit Voltage vs Temperature

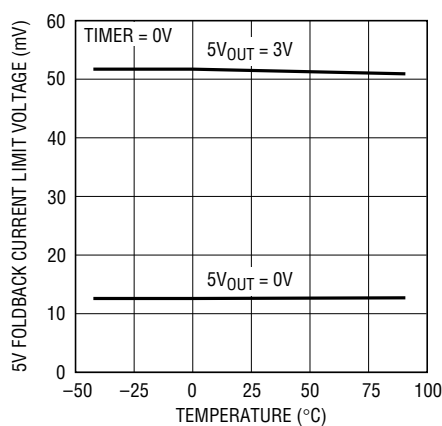

3V Foldback Current Limit Voltage vs Temperature

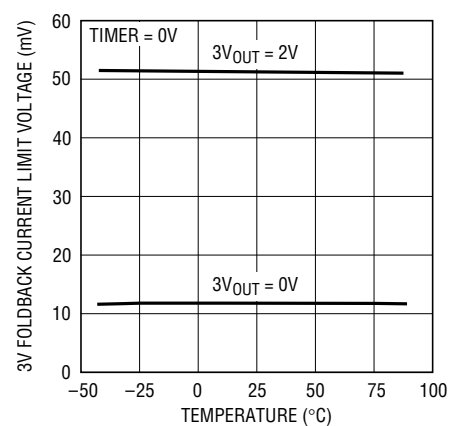

TYPICAL PERFORMANCE CHARACTERISTICS

5V/3.3V Circuit Breaker Trip Voltage vs Temperature

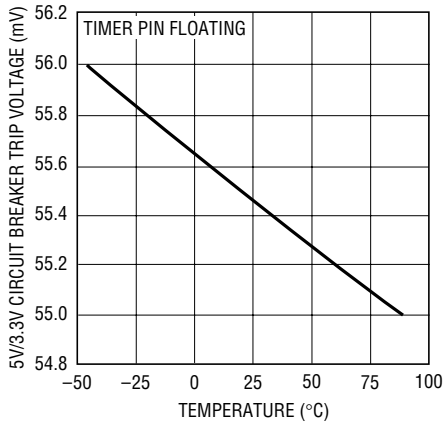

1644 G10

5V/3.3V Circuit Breaker Overcurrent Fault Response Time vs Temperature

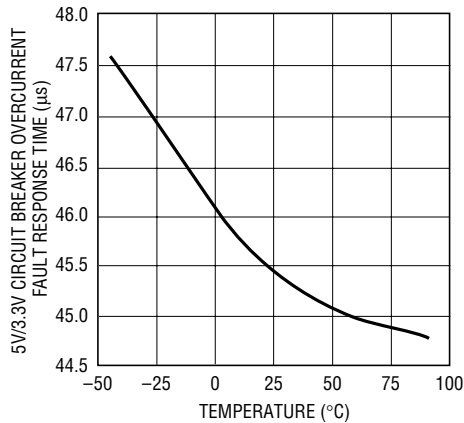

1644 G11

5V/3.3V Circuit Breaker Short-Circuit Response Time vs Temperature

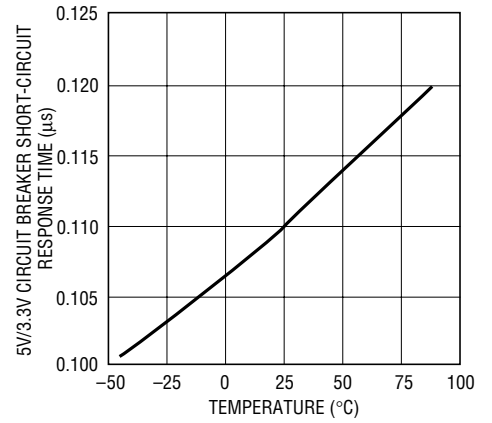

1644 G12

GATE Pin Current vs Temperature (V_{GATE} = 2V, FAULT = 0V)

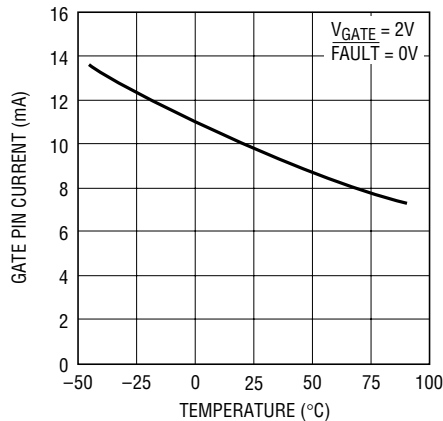

1644 G13

GATE Pin Current vs Temperature (V_{GATE} = 5V, OFF/ON = 4V)

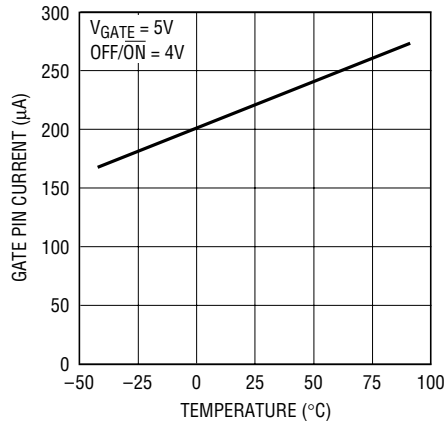

1644 G14

GATE Pin Current vs Temperature (V_{GATE} = 0V, OFF/ON = 0V)

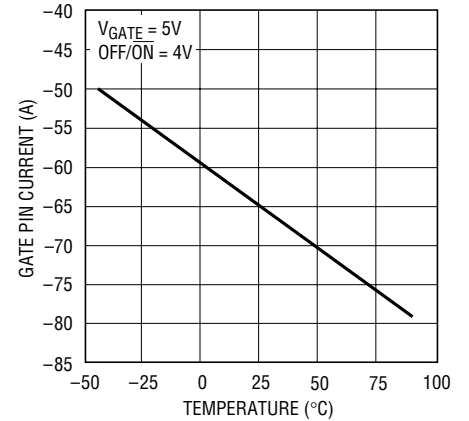

1644 G15

GATE Pin Voltage vs Temperature

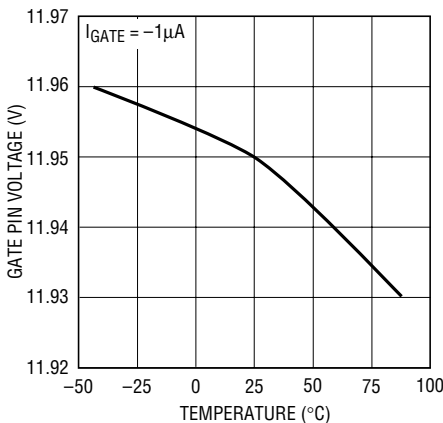

1644 G16

12V Internal Switch Voltage Drop vs Temperature

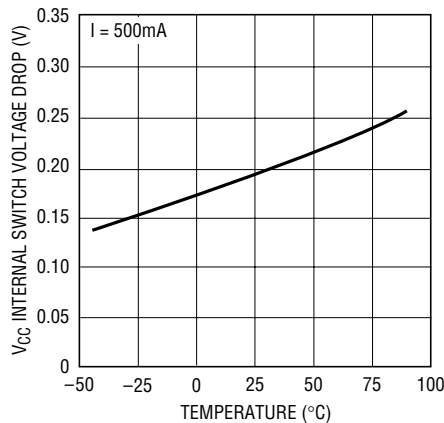

1644 G17

V_{EE} Internal Switch Voltage Drop vs Temperature

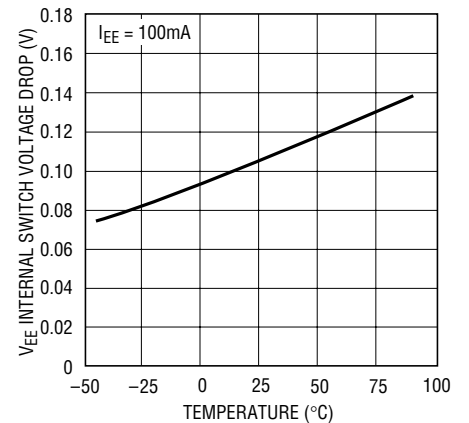

1644 G18

TYPICAL PERFORMANCE CHARACTERISTICS

12V Foldback Current Limit vs Temperature

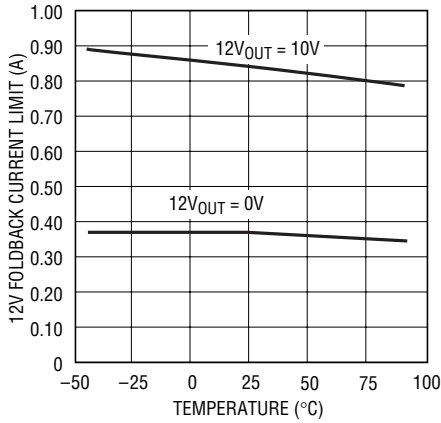

1644 G19

V_{EE} Foldback Current Limit vs Temperature

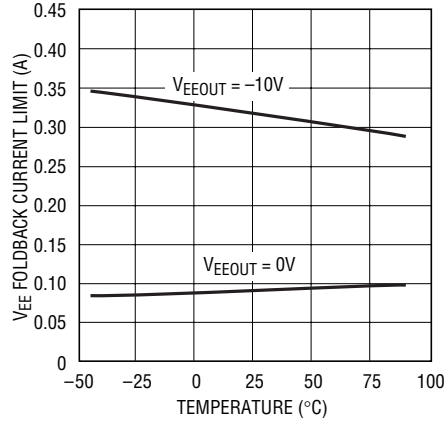

1644 G20

12V_{OUT} PWRGD Threshold Voltage vs Temperature

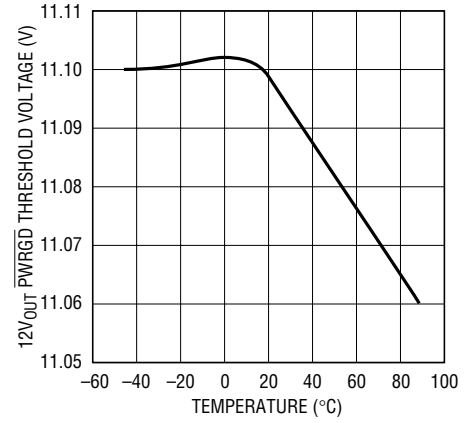

1644 G21

V_{EEOUT} PWRGD Threshold Voltage vs Temperature

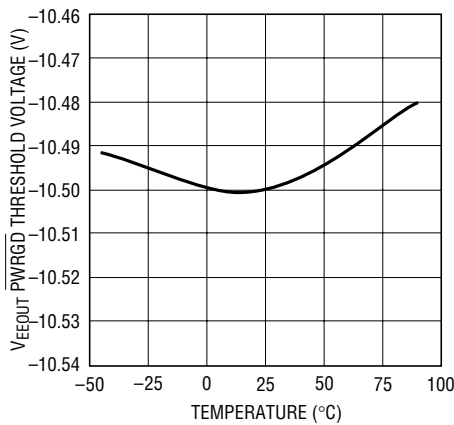

1644 G22

5V_{OUT} PWRGD Threshold Voltage vs Temperature

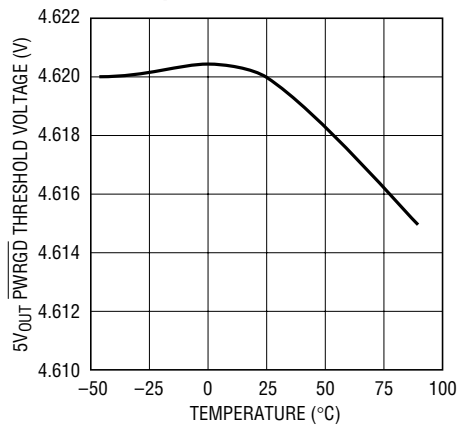

1644 G23

3V_{OUT} PWRGD Threshold Voltage vs Temperature

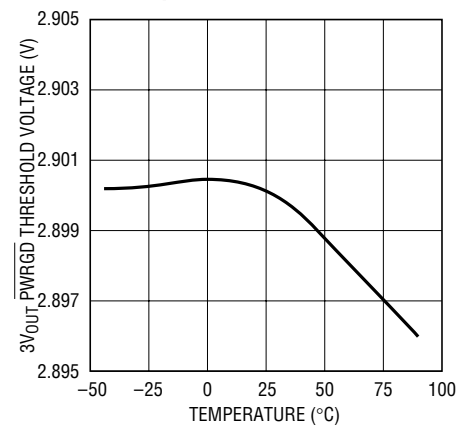

1644 G24

3V Only Window Voltage vs Temperature

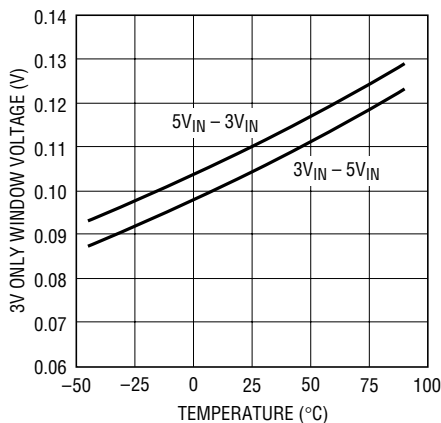

1644 G25

No V_{EEIN} Threshold Voltage vs Temperature

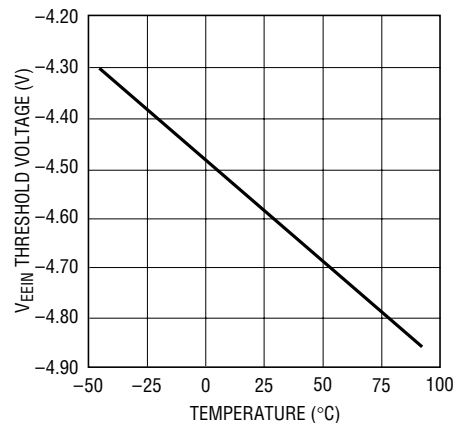

1644 G26

5V_{SENSE} Input Current vs Temperature

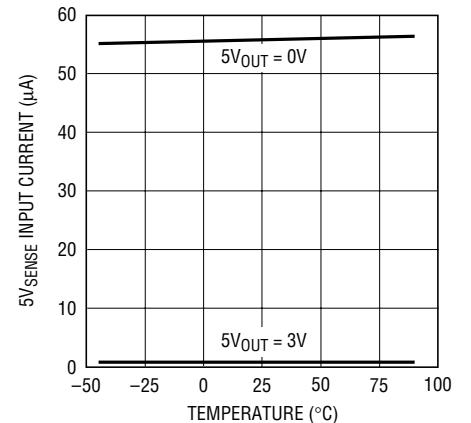

1644 G27

TYPICAL PERFORMANCE CHARACTERISTICS

3V_{SENSE} Input Current vs Temperature

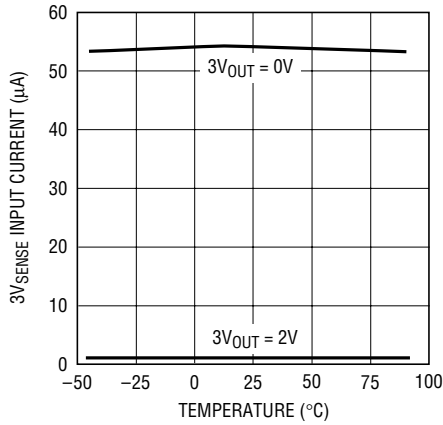

1644 G28

5V_{IN} Input Current vs Temperature

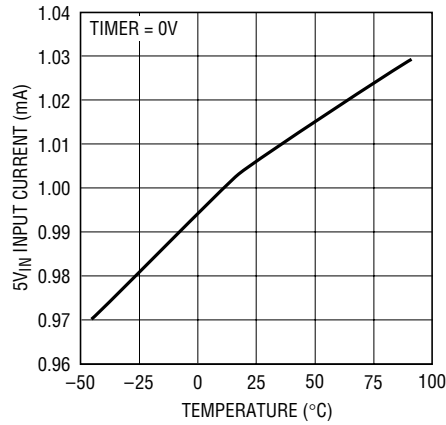

1644 G29

3V_{IN} Input Current vs Temperature

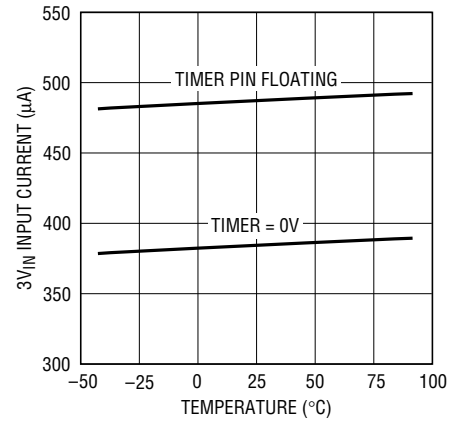

1644 G30

5V_{OUT} Input Current vs Temperature

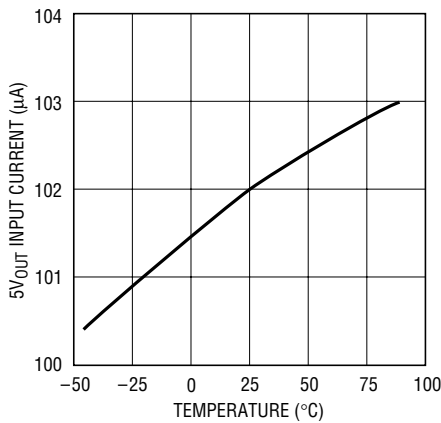

1644 G31

3V_{OUT} Input Current vs Temperature

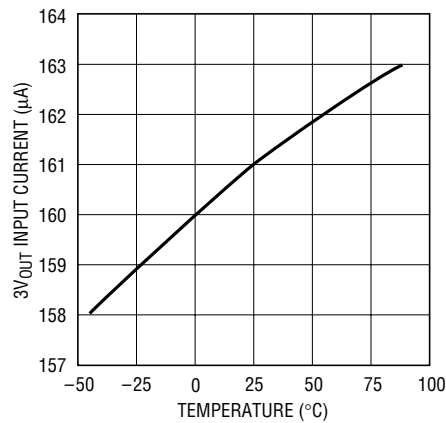

1644 G32

TIMER Pin Current vs Temperature (ON = 0V)

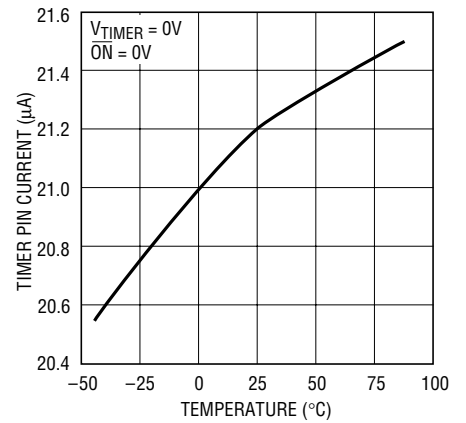

1644 G33

TIMER Pin Current vs Temperature (OFF/ON = 4V)

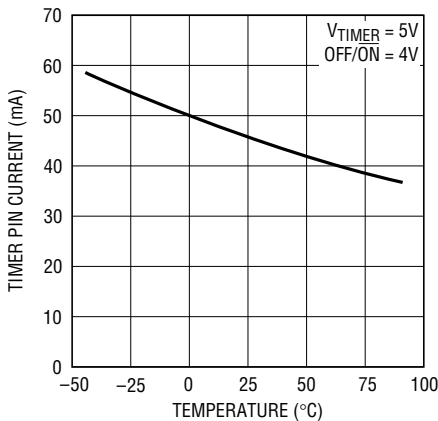

1644 G34

TIMER Threshold Voltage vs Temperature

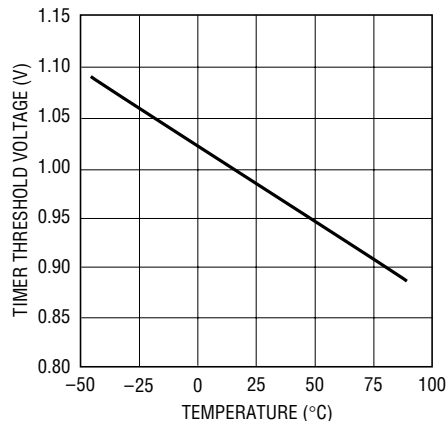

1644 G35

5V_{OUT} Discharge Resistance vs Temperature

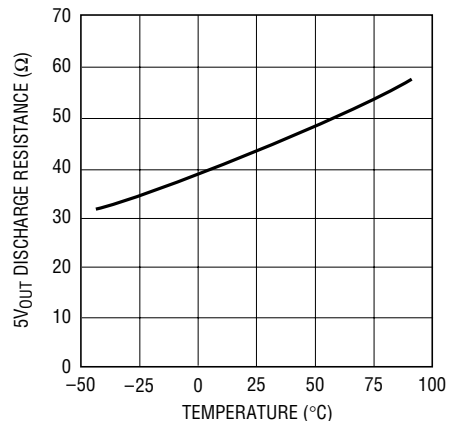

1644 G36

TYPICAL PERFORMANCE CHARACTERISTICS

3V_{OUT} Discharge Resistance vs Temperature

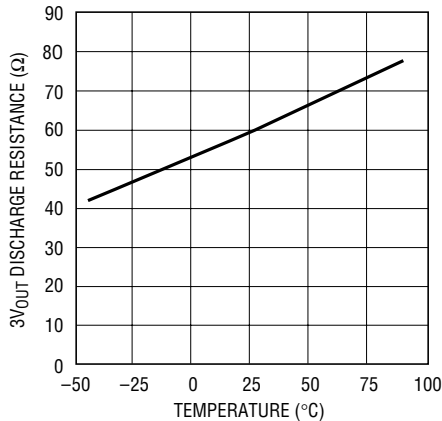

1644 G37

12V_{OUT} Discharge Resistance vs Temperature

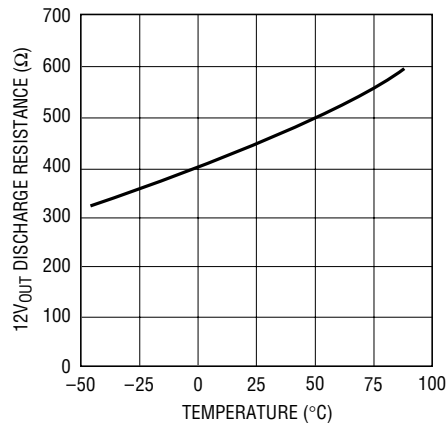

1644 G38

V_{EEOUT} Discharge Resistance vs Temperature

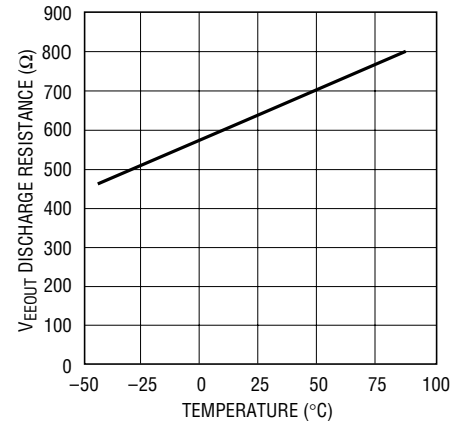

1644 G39

V_{OL} vs Temperature

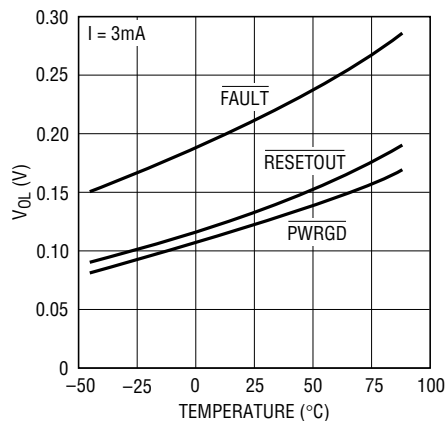

1644 G40

Precharge Reference Voltage vs Temperature

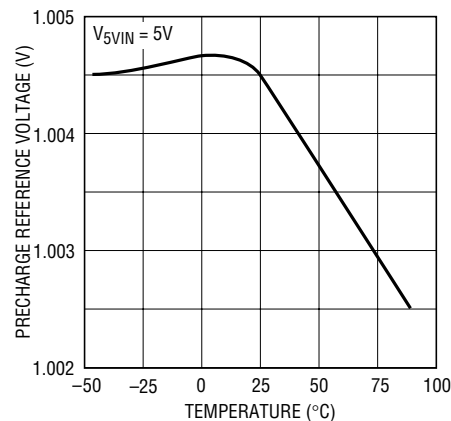

1644 G41

PIN FUNCTIONS

12V_{IN} (Pin 1): 12V Supply Input. A 0.5Ω switch is connected between 12V_{IN} and 12V_{OUT} with a foldback current limit. An undervoltage lockout circuit prevents the switches from turning on while the 12V_{IN} pin voltage is less than 8.3V. 12V_{IN} also provides power to the LTC1644's internal circuitry.

V_{EEIN} (Pin 2): -12V Supply Input. A 1Ω switch is connected between V_{EEIN} and V_{EEOUT} with a foldback current limit. If no V_{EE} supply input is available, tie the V_{EEIN} pin to the GND pin in order to disable the V_{EEOUT} power good function.

5V_{OUT} (Pin 3): 5V Output Sense. The $\overline{\text{PWRGD}}$ pin will not pull low until the 5V_{OUT} pin voltage exceeds 4.62V. If no 5V input supply is available, tie the 5V_{OUT} pin to the 3V_{OUT} pin in order to disable the 5V_{OUT} power good function.

TIMER (Pin 4): Current Fault Inhibit Timing Input. Connect a capacitor from TIMER to GND. With the chip turned off (OFF/ON = HIGH), the TIMER pin is internally held at GND. When the chip is turned on, a 21μA pull-up current source is connected to TIMER. Current limit faults will be ignored until the voltage at the TIMER pin rises to within 1V of 12V_{IN}.

PIN FUNCTIONS

OFF/ON (Pin 5): Digital Input. Connect the CPCI BD_SEL# signal to the OFF/ON pin. When the OFF/ON pin is pulled low, the GATE pin is pulled high by a 65 μ A current source and the internal 12V and -12V switches are turned on. When the OFF/ON pin is pulled high, the GATE pin will be pulled to ground by a 225 μ A current source and the 12V and -12V switches turn off.

The OFF/ON pin is also used to reset the electronic circuit breaker. If the OFF/ON pin is cycled high and low following the trip of the circuit breaker, the circuit breaker is reset and a normal power-up sequence will occur.

FAULT (Pin 6): Open-Drain Digital I/O. FAULT is pulled low when a current limit fault is detected. Current limit faults are ignored until the voltage at the TIMER pin is within 1V of 12V_{IN}. Once the TIMER cycle is complete, FAULT will pull low and the chip latches off in the event of an overcurrent fault. The chip will remain latched in the off state until the OFF/ON pin is cycled high then low.

Forcing the FAULT pin low with an external pull-down will cause the chip to be latched into the off state after a 45 μ s deglitching time.

PWRGD (Pin 7): Open-Drain Digital Power Good Output. Connect the CPCI HEALTHY# signal to the PWRGD pin. PWRGD remains low while $V_{12VOUT} \geq 11.1V$, $V_{3VOUT} \geq 2.9V$, $V_{5VOUT} \geq 4.62V$ and $V_{EEOUT} \leq -10.5V$. When any of the supplies falls below its power good threshold voltage, PWRGD will go high after a 10 μ s deglitching time.

GND (Pin 8): Chip Ground.

RESETIN (Pin 9): Digital Input. Connect the CPCI PCI_RST# signal to the RESETIN pin. Pulling RESETIN low will cause RESETOUT to pull low.

RESETOUT (Pin 10): Open-Drain Digital Output. Connect the CPCI LOCAL_PCI_RST# signal to the RESETOUT pin. RESETOUT is the logical combination of RESETIN and PWRGD.

DRIVE (Pin 11): Precharge Base Drive Output. Provides base drive for an external NPN emitter-follower which in turn biases the PRECHARGE node.

PRECHARGE (Pin 12): Precharge Monitor Input. An on-chip error amplifier servos the DRIVE pin voltage to keep the precharge node at 1V.

5V_{IN} (Pin 13): 5V Supply Sense Input. An undervoltage lockout circuit prevents the switches from turning on when the voltage at the 5V_{IN} pin is less than 2.48V. If no 5V input supply is available, tie the 5V_{IN} to the 3V_{IN} pin.

5V_{SENSE} (Pin 14): 5V Current Limit Sense. With a sense resistor placed in the supply path between 5V_{IN} and 5V_{SENSE}, the GATE pin voltage will be adjusted to maintain a constant 51 mV across the sense resistor and a constant current through the switch while the TIMER pin is low. A foldback feature reduces the current limit as the voltage at the 5V_{OUT} pin approaches GND.

When the TIMER pin is high, the circuit breaker function is enabled. If the voltage across the sense resistor exceeds 55mV but is less than 150mV, the circuit breaker is tripped after a 45 μ s time delay. In the event the sense resistor voltage exceeds 150mV, the circuit breaker trips immediately and the chip latches off. To disable the current limit, 5V_{SENSE} and 5V_{IN} can be shorted together.

GATE (Pin 15): High Side Gate Drive for the External 3.3V and 5V N-Channels pass transistors. Requires an external series RC network to compensate the current limit loop and set the minimum ramp-up rate. During power up, the slope of the voltage rise at the GATE is set by the 65 μ A current source connected to 12V_{IN} and the external capacitor connected to GND (C1, see Figure 1) or by the 3.3V or 5V current limit and the bulk capacitance on the 3V_{OUT} or 5V_{OUT} supply lines (C_{LOAD(5VOUT)} or C_{LOAD(3VOUT)}, see Figure 1). During power down, the slew rate of the GATE voltage is set by the 225 μ A current source connected to GND and the external GATE capacitor (C1, see Figure 1).

The voltage at the GATE pin will be modulated to maintain a constant current when either the 3V or 5V supplies go into current limit while the TIMER pin is low. In the event of a fault or an undervoltage condition, the GATE pin is immediately pulled to GND.

3V_{SENSE} (Pin 16): 3.3V Current Limit Set. With a sense resistor placed in the supply path between 3V_{IN} and 3V_{SENSE}, the GATE pin voltage will be adjusted to maintain a constant 51 mV across the sense resistor and a constant current through the switch while the TIMER pin is low. A foldback feature reduces the current limit as the voltage at the 3V_{OUT} pin approaches GND.

PIN FUNCTIONS

When the **TIMER** pin is high, the circuit breaker function is enabled. If the voltage across the sense resistor exceeds 55mV but is less than 150mV, the circuit breaker is tripped after a 45μs time delay. In the event the sense resistor voltage exceeds 150mV, the circuit breaker trips immediately and the chip latches off. To disable the current limit, **3V_{SENSE}** and **3V_{IN}** can be shorted together.

3V_{IN} (Pin 17): 3.3V Supply Sense Input. An undervoltage lockout circuit prevents the switches from turning on when the voltage at the **3V_{IN}** pin is less than 2.48V. If no 3.3V input supply is available, connect two series diodes between **5V_{IN}** and **3V_{IN}** (tie anode of first diode to **5V_{IN}** and cathode of second diode to **3V_{IN}**, see Figure 11).

3V_{OUT} (Pin 18): Analog Input used to monitor the 3.3V output supply voltage. The **PWRGD** pin cannot pull low until the **3V_{OUT}** pin voltage exceeds 2.9V. If no 3.3V input supply is available, tie the **3V_{OUT}** pin to the **5V_{OUT}** pin.

V_{EEOUT} (Pin 19): -12V Supply Output. A 1Ω switch is connected between **V_{EEIN}** and **V_{EEOUT}**. **V_{EEOUT}** must exceed -10.5V before the **PWRGD** pin pulls low unless the **V_{EE}** **PWRGD** function is disabled by grounding the **V_{EEIN}** pin.

12V_{OUT} (Pin 20): 12V Supply Output. A 0.5Ω switch is connected between **12V_{IN}** and **12V_{OUT}**. **12V_{OUT}** must exceed 11.1V before the **PWRGD** pin can pull low.

BLOCK DIAGRAM

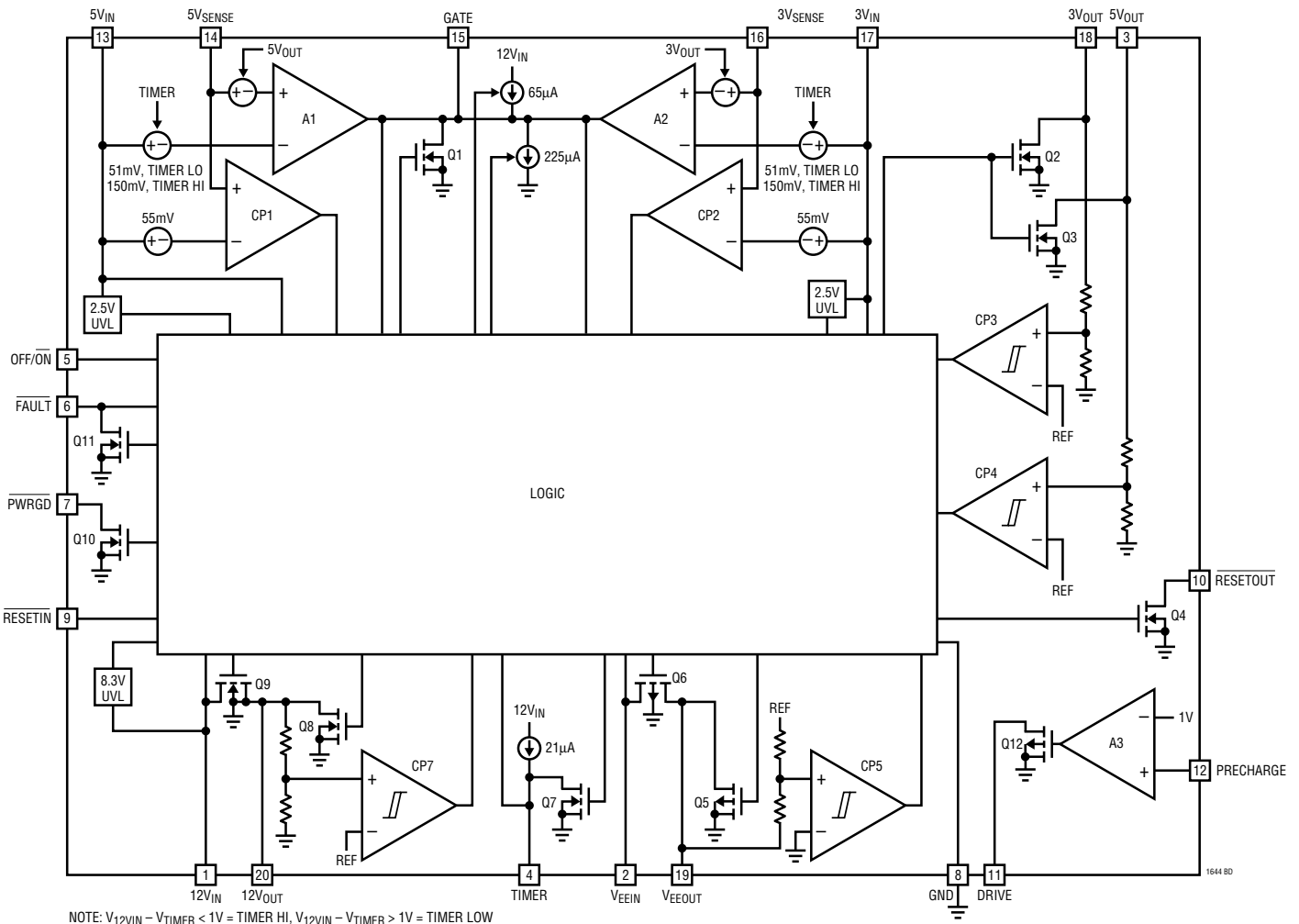

TIMING DIAGRAMS

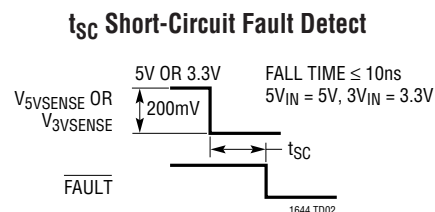
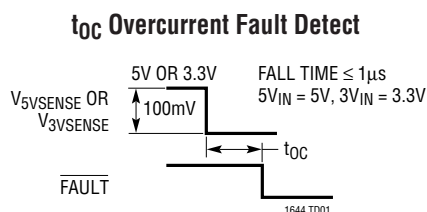

APPLICATIONS INFORMATION

Hot Circuit Insertion

When a circuit board is inserted into a live CompactPCI (CPCI) slot, the supply bypass capacitors on the board can draw huge supply transient currents from the CPCI power bus as they charge up. The transient currents can cause glitches on the power bus, causing other boards in the system to reset.

The LTC1644 is designed to turn a board's supply voltages on and off in a controlled manner, allowing the board to be safely inserted or removed from a live CPCI slot without glitching the system power supplies. The chip also protects the supplies from shorts, precharges the bus I/O pins during insertion and extraction and monitors the supply voltages.

The LTC1644 is specifically designed for CPCI applications where the chip resides on the plug-in board.

LTC1644 Feature Summary

- Allows safe board insertion and removal from a CPCI backplane.
- Controls all four CPCI supplies: -12V , 12V , 3.3V and 5V .
- Adjustable foldback current limit: an adjustable analog current limit with a value that depends on the output voltage. If the output is shorted to ground, the current limit drops to keep power dissipation and supply glitches to a minimum.
- 12V and -12V circuit breakers: if either supply remains in current limit too long, the circuit breaker will trip, the supplies are turned off and the FAULT pin is pulled low.
- Dual-level, adjustable 5V and 3.3V circuit breakers: if either supply exceeds current limit for too long, the circuit breaker will trip, the supplies will be turned off and the FAULT pin will be asserted. In the event that

either supply exceeds 3 times the nominal current level, all supplies will be turned off and the FAULT pin will be asserted immediately.

- Current limit during power up: the supplies are allowed to power up in current limit. This allows the chip to power up boards with widely varying capacitive loads without tripping the circuit breaker. The maximum allowable power-up time is adjustable using the TIMER pin.
- 12V and -12V power switches on chip.
- PWRGD output: monitors the voltage status of the four supply voltages.
- PCI_RST# combined on-chip with HEALTHY# to create LOCAL_PCI_RST# output. If HEALTHY# deasserts, LOCAL_PCI_RST# is asserted independent of PCI_RST#.
- Precharge output: on-chip reference and amplifier provide 1V for biasing bus I/O connector pins during CPCI card insertion and extraction.
- Space saving 20-pin SSOP package.

CPCI Power Requirements

CPCI systems usually require four power rails: 5V , 3.3V , 12V and -12V . The tolerance of the supplies as measured at the components on the plug-in card is summarized in Table 1.

Table 1. Compact PCI Power Specifications

SUPPLY	TOLERANCE	MAX RIPPLE (p.p)
5V	+5%/-3%	50mV
3.3V	+5%/-3%	50mV
12V	$\pm 5\%$	240mV
-12V	$\pm 5\%$	240mV

1644f

APPLICATIONS INFORMATION

Power-Up Sequence

The LTC1644 is specifically designed for live insertion and removal of CPCI boards. The typical application is shown in Figure 1. The 3.3V, 5V, 12V and –12V inputs to the LTC1644 come from the medium length power pins. The long 5V and 3.3V connector pins are connected through decoupling resistors to the medium length 5V and 3.3V connector pins on the CPCI plug-in card and provide early power for the LTC1644's precharge circuit, pull-up resistors and the PCI bridge chip. The `BD_SEL#` signal is connected to the `OFF/ON` pin while the `PWRGD` pin is connected to the `HEALTHY#` signal. The `HEALTHY#` signal is combined with the `PCI_RST#` signal on-chip to generate the `LOCAL_PCI_RST#` signal which is available at the `RESETOUT` pin.

The power supplies are controlled by placing external N-channel pass transistors in the 3.3V and 5V power paths and internal pass transistors for the 12V and –12V power paths (Figure 1).

Resistors R1 and R2 provide current fault detection and R5 and C1 provide current control loop compensation. Resistors R3 and R4 prevent high frequency oscillations in Q1 and Q2. Shunt RC snubbers R15-C4 and R16-C5 and zener diodes Z1 and Z2 prevent the 12V_{IN} and V_{EEIN} pins, respectively, from ringing beyond the absolute maximum rated supply voltages during hot insertion.

When the CPCI card is inserted, the long 5V and 3.3V connector pins and GND pins make contact first. The LTC1644's precharge circuit biases the bus I/O pins to 1V during this stage of the insertion (Figure 2). The 12V, –12V and 5V and 3.3V medium length pins make contact during the next stage of insertion. At this point the LTC1644 powers on but slot power is disabled as long as the `OFF/ON` pin is pulled high by the 1.2k pull-up resistor to 5V_{IN}. During the final stage of board insertion, the `BD_SEL#` short connector pin makes contact and the `OFF/ON` pin can

be pulled low. This enables the pass transistors to turn on and a 21μA current source is connected to `TIMER` (Pin 4).

The current in each pass transistor increases until it reaches the current limit for each supply. The 5V and 3.3V supplies are then allowed to power up based on one of the following rates:

Power-up rate: (1)

$$\frac{dV}{dt} = \frac{65\mu A}{C1}, \text{ or } = \frac{I_{LIMIT(5V)}}{C_{LOAD(5VOUT)}}, \text{ or } = \frac{I_{LIMIT(3V)}}{C_{LOAD(3VOUT)}}$$

whichever is slower.

Current limit faults are ignored while the `TIMER` pin voltage is ramping up and is less than 1V below 12V_{IN} (Pin 1). Once all four supply voltages are within tolerance, `HEALTHY#` (Pin 7) will pull low and `LOCAL_PCI_RST#` is free to follow `PCI_RST#`.

Power-Down Sequence

When the `BD_SEL#` is pulled high, a power-down sequence begins (Figure 3).

Internal switches are connected to each of the output supply voltage pins to discharge the bypass capacitors to ground. The `TIMER` pin is immediately pulled low. The `GATE` pin (Pin 15) is pulled down by a 225μA current source to prevent the load currents on the 3.3V and 5V supplies from going to zero instantaneously and glitching the power supply voltages. When any of the output voltages dips below its threshold, the `HEALTHY#` signal pulls high and `LOCAL_PCI_RST#` will be asserted low.

Once the power-down sequence is complete, the CPCI card may be removed from the slot. During extraction, the precharge circuit will continue to bias the bus I/O pins at 1V until the 5V and 3.3V long connector pin connections are broken.

APPLICATIONS INFORMATION

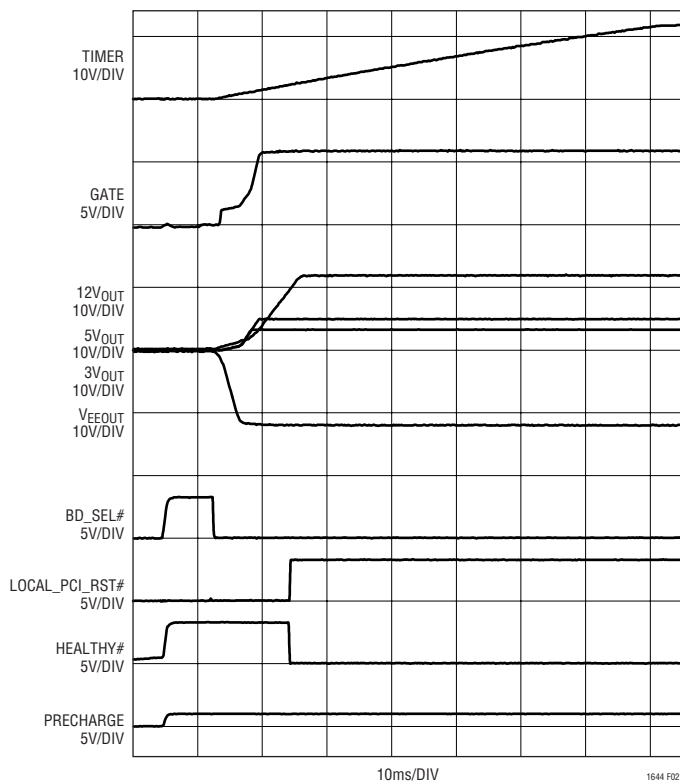

Figure 2. Normal Power-Up Sequence

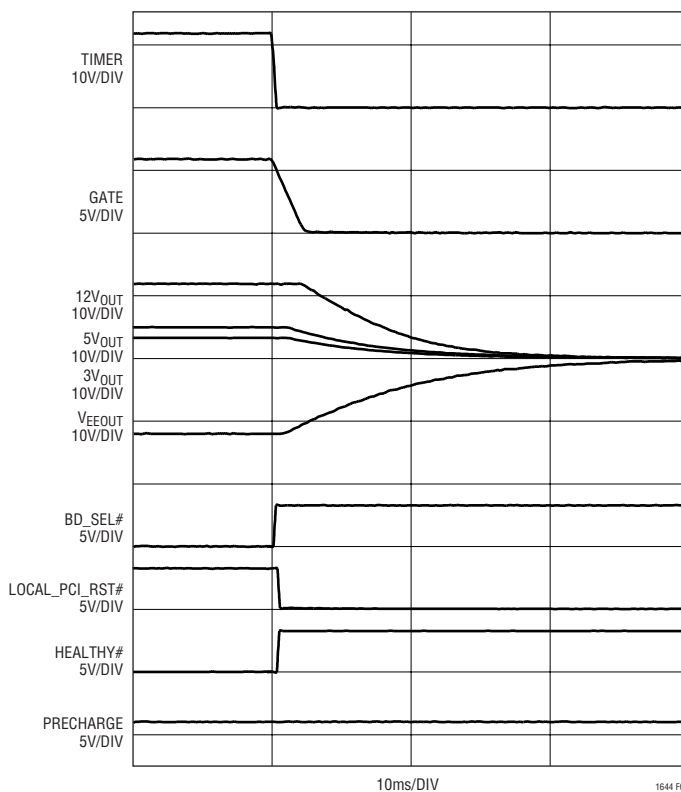

Figure 3. Normal Power-Down Sequence

TIMER

During a power-up sequence, a $21\mu\text{A}$ current source is connected to the TIMER pin (Pin 4) and current limit faults are ignored until the voltage ramps to within 1V of 12V_{IN} (Pin 1). This feature allows the chip to power up CPCI boards with widely varying capacitive loads on the supplies. The power-up time for any one of the four outputs is given by Equation 2:

$$t_{\text{ON}}(XV_{\text{OUT}}) = 2 \cdot \left(\frac{C_{\text{LOAD}}(XV_{\text{OUT}}) \cdot XV_{\text{OUT}}}{I_{\text{LIMIT}}(XV_{\text{OUT}}) - I_{\text{LOAD}}(XV_{\text{OUT}})} \right) \quad (2)$$

where $XV_{\text{OUT}} = 5\text{V}_{\text{OUT}}, 3\text{V}_{\text{OUT}}, 12\text{V}_{\text{OUT}}$ or $V_{\text{EEOUT}} (-12\text{V})$. For example, for $C_{\text{LOAD}}(5\text{V}_{\text{OUT}}) = 2000\mu\text{F}$, $I_{\text{LIMIT}}(5\text{V}_{\text{OUT}}) = 7\text{A}$ and $I_{\text{LOAD}}(5\text{V}_{\text{OUT}}) = 5\text{A}$, the 5V_{OUT} turn-on time will be

$\sim 10\text{ms}$. By substituting the variables in Equation 2 with the appropriate values, the turn-on time for the other three outputs can be calculated.

The timer period should be set longer than the maximum supply turn-on time but short enough to not exceed the maximum safe operating area of the pass transistor during a short circuit. The timer period for the LTC1644 is given by:

$$t_{\text{TIMER}} = \frac{C_{\text{TIMER}} \cdot 11\text{V}}{21\mu\text{A}} \quad (3)$$

As a design aid, the timer period as a function of the timing capacitor using standard values from $0.01\mu\text{F}$ to $1\mu\text{F}$ is shown in Table 2.

APPLICATIONS INFORMATION

Table 2. t_{TIMER} vs C_{TIMER}

C_{TIMER}	t_{TIMER}	C_{TIMER}	t_{TIMER}
0.01 μF	5.24ms	0.22 μF	115ms
0.022 μF	11.5ms	0.33 μF	173ms
0.033 μF	17.3ms	0.47 μF	246ms
0.047 μF	24.6ms	0.68 μF	356ms
0.068 μF	35.6ms	0.82 μF	430ms
0.082 μF	43.0ms	1 μF	524ms
0.1 μF	52.4ms		

The TIMER pin is immediately pulled low when the $\text{BD_SEL}\#$ signal goes high.

Thermal Shutdown

The internal switches for the 12V and -12V supplies are protected by an internal current limit and a thermal shutdown circuit. When the temperature of the chip reaches 130°C , all switches will be latched off and the FAULT pin (Pin 6) will be pulled low.

Short-Circuit Protection

During a normal power-up sequence, if the TIMER (Pin 4) is done ramping and any supply is still in current limit, all of the pass transistors will be immediately turned off and FAULT (Pin 6) will be pulled low as shown in Figure 4.

In order to prevent excessive power dissipation in the pass transistors and to prevent voltage spikes on the supplies during short-circuit conditions, the current limit on each supply is designed to be a function of the output voltage. As the output voltage drops, the current limit decreases. Unlike a traditional circuit breaker function where large currents can flow before the breaker trips, the current foldback feature assures that the supply current will be kept at a safe level. In addition, current foldback prevents voltage glitches when powering up into a short.

If either the 12V or -12V supply exceeds current limit after power up, the shorted supply's current will drop immediately to its I_{LIMIT} value. If that supply remains in current limit for more than $45\mu\text{s}$, all of the supplies will be latched off. The $45\mu\text{s}$ delay prevents quick current spikes—for example, from a fan turning on—from causing false trips of the circuit breaker.

After power-up, the 5V and 3.3V supplies are protected from overcurrent and short-circuit conditions by dual-level circuit breakers. In the event that either supply current exceeds the nominal limit but is less than 3 times the current limit, an internal timer is started. If the supply is still overcurrent after $45\mu\text{s}$, the circuit breaker trips and all the supplies are turned off (Figure 5). If a short-circuit occurs and the supply current exceeds 3 times the set limit, the circuit breakers trip without any delay and the chip latches off (Figure 6). The chip will stay in the latched off state until OFF/ON (Pin 5) is cycled high then low or the 12V_{IN} (Pin 1) power supply is cycled off then on.

The current limit and the foldback current level for the 5V and 3.3V outputs are both a function of the external sense resistor (R_1 for 3V_{OUT} and R_2 for 5V_{OUT} , see Figure 1). As shown in Figure 1, a sense resistor is connected between 5V_{IN} (Pin 13) and 5V_{SENSE} (Pin 12) for the 5V supply. For the 3V supply, a sense resistor is connected between 3V_{IN} (Pin 9) and 3V_{SENSE} (Pin 10). The current limit and the foldback current level are given by Equations 4 and 5:

$$I_{\text{LIMIT}(X\text{VOUT})} = \frac{51\text{mV}}{R_{\text{SENSE}(X\text{VOUT})}} \quad (4)$$

$$I_{\text{FOLDBACK}(X\text{VOUT})} = \frac{12\text{mV}}{R_{\text{SENSE}(X\text{VOUT})}} \quad (5)$$

where $X\text{V}_{\text{OUT}} = 5\text{V}_{\text{OUT}}$ or 3V_{OUT} .

As a design aid, the current limit and foldback level for commonly used values for R_{SENSE} is shown in Table 3.

Table 3. $I_{\text{LIMIT}(X\text{VOUT})}$ and $I_{\text{FOLDBACK}(X\text{VOUT})}$ vs R_{SENSE}

$R_{\text{SENSE}} (\Omega)$	$I_{\text{LIMIT}(X\text{VOUT})}$	$I_{\text{FOLDBACK}(X\text{VOUT})}$
0.005	10.2A	2.4A
0.006	8.5A	2.0A
0.007	7.3A	1.7A
0.008	6.4A	1.5A
0.009	5.7A	1.3A
0.01	5.1A	1.2A

where $X\text{V}_{\text{OUT}} = 3\text{V}_{\text{OUT}}$ or 5V_{OUT} .

The current limit for the internal 12V switch is set at 840mA folding back to 360mA and the -12V switch at 320mA folding back to 100mA.

APPLICATIONS INFORMATION

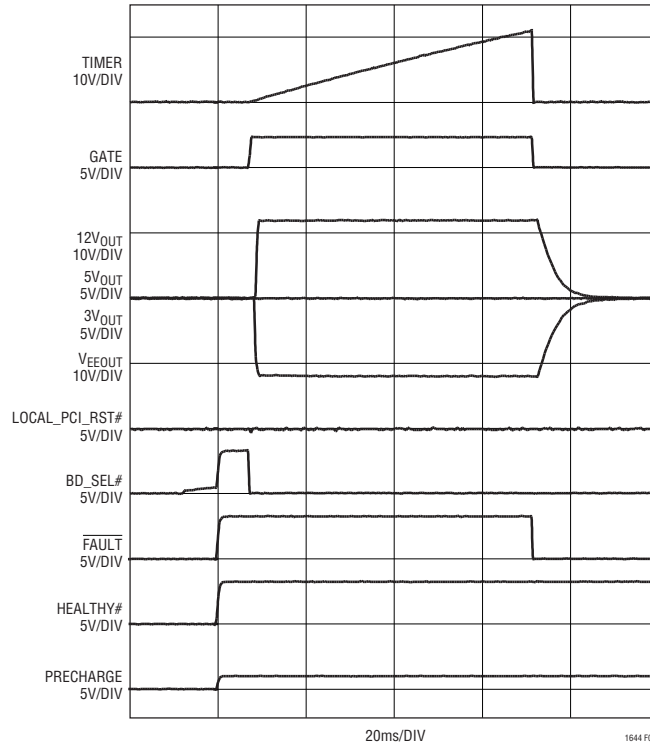

Figure 4. Power-Up into a Short on 3.3V Output

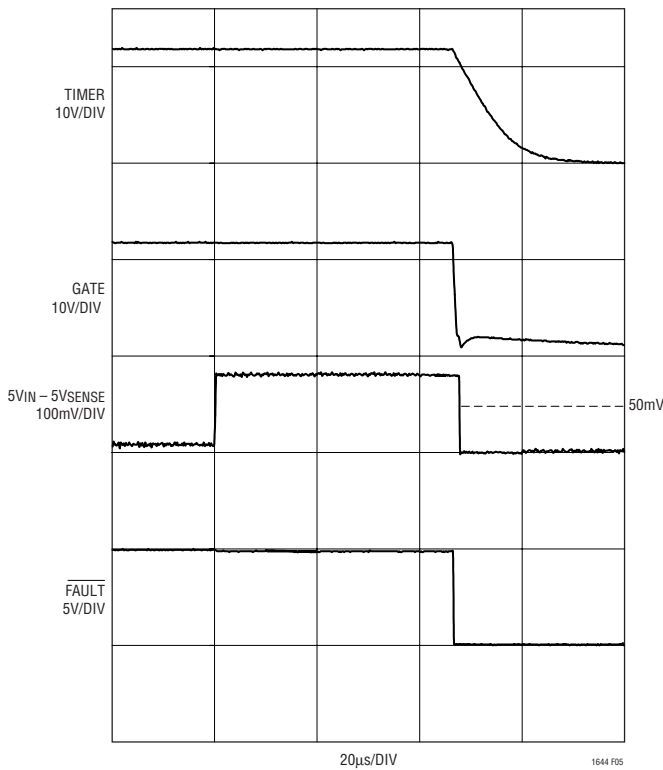

Figure 5. Overcurrent Fault on 5V

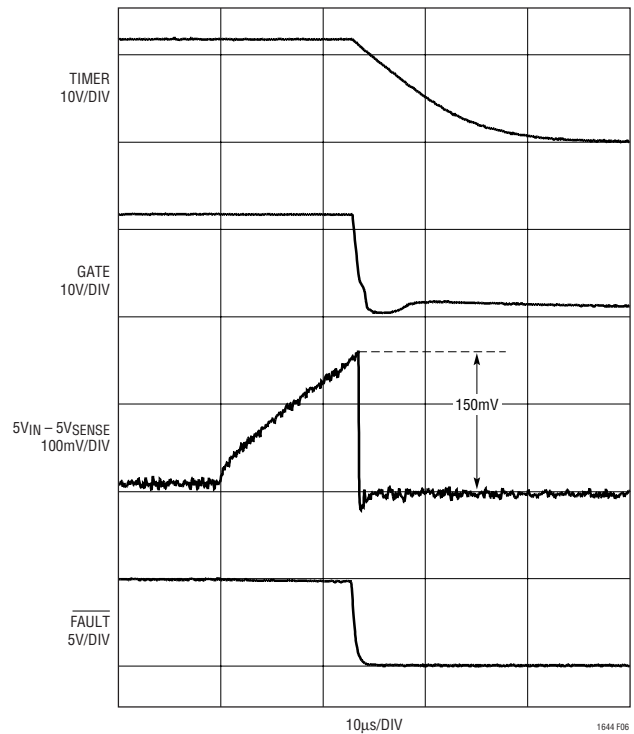

Figure 6. Short-Circuit Fault on 5V

APPLICATIONS INFORMATION

Calculating R_{SENSE}

An equivalent circuit for one of the LTC1644's circuit breakers useful in calculating the value of the sense resistor is shown in Figure 7. To determine the most appropriate value for the sense resistor first requires the maximum current required by the load under worst-case conditions.

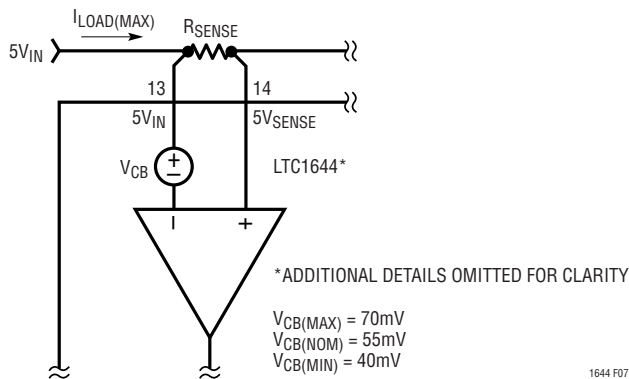

Figure 7. Circuit Breaker Equivalent Circuit for Calculating R_{SENSE}

Two other parameters affect the value of the sense resistor. First is the tolerance of the LTC1644's circuit breaker threshold. The LTC1644's nominal circuit breaker threshold is $V_{CB(NOM)} = 55\text{mV}$; however, it exhibits $\pm 15\text{mV}$ tolerance over process and temperature. Second is the tolerance (RTOL) in the sense resistor. Sense resistors are available in RTOLs of $\pm 1\%$, $\pm 2\%$ and $\pm 5\%$ and exhibit temperature coefficients of resistance (TCRs) between $\pm 75\text{ppm}/^\circ\text{C}$ and $\pm 100\text{ppm}/^\circ\text{C}$. How the sense resistor changes as a function of temperature depends on the I^2R power being dissipated by it. The power rating of the sense resistor should accommodate steady-state fault current levels so that the component is not damaged before the circuit breaker trips.

The first step in calculating the value of R_{SENSE} is based on I_{LOAD(MAX)} and the lower limit for the circuit breaker threshold, V_{CB(MIN)}. The maximum value for R_{SENSE} in this case is expressed by Equation 6:

$$R_{SENSE} = \frac{V_{CB(MIN)}}{I_{LOAD(MAX)}} \quad (6)$$

The second step is to determine the nominal value of the sense resistor which is dependent on its tolerance (RTOL = $\pm 1\%$, $\pm 2\%$, or $\pm 5\%$) and standard sense resistor values. Equation 7 can be used to calculate the nominal value from the maximum value found by Equation 6:

$$R_{SENSE(NOM)} = \frac{R_{SENSE(MAX)}}{1 + \left(\frac{RTOL}{100}\right)} \quad (7)$$

Often, the result of Equation 7 may not yield a standard sense resistor value. In this case, two sense resistors with the same RTOL can be connected in parallel to yield R_{SENSE(NOM)}.

The last step requires calculating a new value for I_{TRIP(MAX,NEW)} based on a minimum value for R_{SENSE} (R_{SENSE(MIN)}) and the upper limit for the circuit breaker threshold, V_{CB(MAX)}. The new value for I_{TRIP(MAX,NEW)} is given by Equation 8:

$$I_{TRIP(MAX,NEW)} = \frac{V_{CB(MAX)}}{R_{SENSE(MIN)}} \quad (8)$$

$$\text{where } R_{SENSE(MIN)} = R_{SENSE(NOM)} \cdot \left[1 - \left(\frac{RTOL}{100}\right)\right]$$

Table 4 lists I_{TRIP(MIN)} and I_{TRIP(MAX)} versus some suggested values of R_{SENSE}. Table 8 lists manufacturers and part numbers for these resistor values.

Table 4. I_{TRIP} vs R_{SENSE} Table

R _{SENSE} (1% RTOL)	I _{TRIP(MIN)}	I _{TRIP(MAX)}
0.005Ω	7.92A	14.14A
0.007Ω	5.66A	10.10A
0.011Ω	3.60A	6.43A
0.028Ω	1.41A	2.53A
0.055Ω	0.72A	1.29A

APPLICATIONS INFORMATION

Output Voltage Monitor

The status of all four output voltages is monitored by the power good function. In addition, the PCI_RST# signal is logically combined on-chip with the HEALTHY# signal to create LOCAL_PCI_RST# (see Table 5). As a result, LOCAL_PCI_RST# will be pulled low whenever HEALTHY# is pulled high independent of the state of the PCI_RST# signal.

Table 5. LOCAL_PCI_RST# Truth Table

PCI_RST#	HEALTHY#	LOCAL_PCI_RST#
LO	LO	LO
LO	HI	LO
HI	LO	HI
HI	HI	LO

If any of the output voltages drop below the power good threshold for more than 10 μ s, the PWRGD pin will be pulled high and the LOCAL_PCI_RST# signal will be asserted low.

Precharge

The PRECHARGE input and DRIVE output pins are intended for use in generating the 1V precharge voltage that is used to bias the bus I/O connector pins during board insertion. The LTC1644 is also capable of generating precharge voltages other than 1V. Figure 8 shows a circuit that can be used in applications requiring a precharge voltage less than 1V. The circuit in Figure 9 can be used for applications that need precharge voltages greater than 1V. Table 6 lists suggested resistor values for R10A and R10B vs precharge voltage for the application circuits shown in Figures 8 and 9.

Table 6. R10A and R10B Resistor Values vs Precharge Voltage

V _{PRECHARGE}	R10A	R10B	V _{PRECHARGE}	R10A	R10B
1.5V	18 Ω	9.09 Ω	0.9V	16.2 Ω	1.78 Ω
1.4V	18 Ω	7.15 Ω	0.8V	14.7 Ω	3.65 Ω
1.3V	18 Ω	5.36 Ω	0.7V	12.1 Ω	5.11 Ω
1.2V	18 Ω	3.65 Ω	0.6V	11 Ω	7.15 Ω
1.1V	18 Ω	1.78 Ω	0.5V	9.09 Ω	9.09 Ω
1V	18 Ω	0 Ω			

Due to leakage current constraints, precharge resistor values of less than 50k are often required. In these

precharge applications, it may also be necessary to disconnect the individual resistors from the LTC1644's PRECHARGE pin when the plug-in board is completely seated in the board slot. The circuit in Figure 10 uses a bus switch to connect the individual precharge resistors to the LTC1644's PRECHARGE pin while the BD_SEL# pin voltage is pulled up to 5V_{IN}, i.e., when the BD_SEL# short connector pin is still unconnected. After the plug-in board is completely seated, the BD_SEL# pin voltage will drop to approximately 3.8V (assuming BD_SEL# isn't asserted low), and the bus switch OE pin is pulled high by Q2. When the plug-in card is removed from the connector, the BD_SEL# connection is broken first and the BD_SEL# pin voltage pulls up to 5V. This causes Q2 to turn off, which re-enables the bus switch and the precharge resistors are reconnected to the LTC1644's PRECHARGE pin for the remainder of the board extraction process.

Other CompactPCI Applications

The LTC1644 can be easily configured for applications where no V_{EE} supply is present by simply connecting the V_{EEIN} pin to GND and floating the V_{EEOUT} pin (Figure 11).

For CPCI applications where no 5V supply input is required, short both the 5V_{IN} and 5V_{SENSE} pins to the 3V_{IN} pin and short the 5V_{OUT} pin to the 3V_{OUT} pin (Figure 12).

If no 3.3V supply input is required, Figure 13 illustrates how the LTC1644 should be configured. First, 3V_{SENSE} (Pin 16) is connected to 3V_{IN} (Pin 17), 3V_{OUT} (Pin 18) is connected to 5V_{OUT} (Pin 3) and the LTC1644's 3V_{IN} pin is connected through a pair of signal diodes (BAV99) to 5V_{IN}.

For applications where the BD_SEL# connector pin is typically grounded on the backplane, the circuit in Figure 14 allows the LTC1644 to be reset simply by pressing a pushbutton switch on the CPCI plugin board. This arrangement eliminates the requirement to extract and reinsert the CPCI board in order to reset the LTC1644's circuit breakers.

Power MOSFET Selection Criteria

Three device parameters are key in selecting the optimal power MOSFET for Hot Swap applications. The three parameters are: (1) device power dissipation (P_D); (2) device drain-source channel ON resistance, R_{DS(ON)}; and

APPLICATIONS INFORMATION

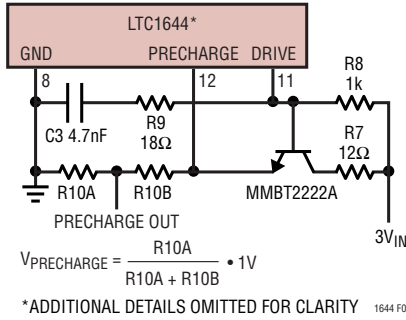

Figure 8. Precharge Voltage <1V Application Circuit

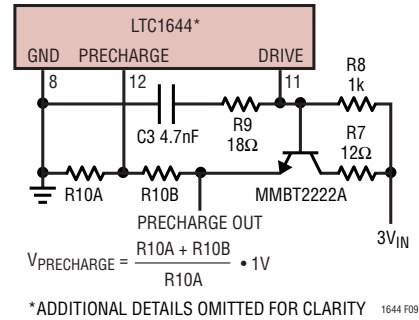

Figure 9. Precharge Voltage >1V Application Circuit

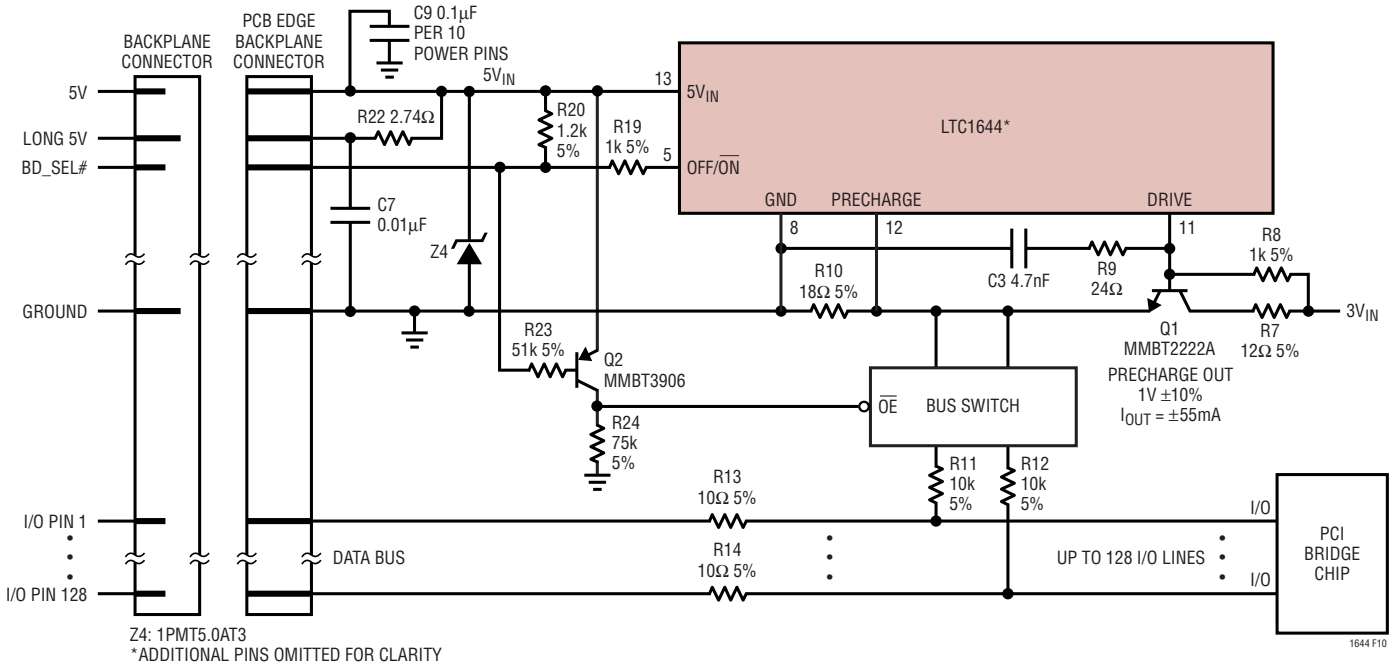

Figure 10. Precharge Circuit with Bus Switch

(3) the gate-source (V_{GS}) voltage drive for the specified $R_{DS(ON)}$. Power MOSFET power dissipation is dependent on four parameters: current delivered to the load, I_{LOAD} ; device $R_{DS(ON)}$; device thermal resistance, junction-to-ambient, θ_{JA} ; and the maximum ambient temperature to which the circuit will be exposed, $T_{A(MAX)}$. All four of these parameters determine the junction temperature of the MOSFET. For reliable circuit operation, the maximum junction temperature ($T_{J(MAX)}$) for a power MOSFET should not exceed the manufacturer's recommended value. For a given set of conditions, the junction temperature of a power MOSFET is given by Equation 9:

$$T_{J(MAX)} \leq T_{A(MAX)} + \theta_{JA} \cdot P_D \tag{9}$$

where $P_D = I_{LOAD} \cdot R_{DS(ON)}$

PCB layout techniques for optimal thermal management of power MOSFET power dissipation help to keep device θ_{JA} as low as possible. See PCB Layout Considerations section for more information.

The $R_{DS(ON)}$ of the external pass transistor should be low to make its drain-source voltage (V_{DS}) a small percentage of $3V_{IN}$ or $5V_{IN}$. For example, at $3V_{IN} = 3.3V$, $V_{DS} + V_{CB} = 0.1V$ yields a 3% error at maximum load current. This

APPLICATIONS INFORMATION

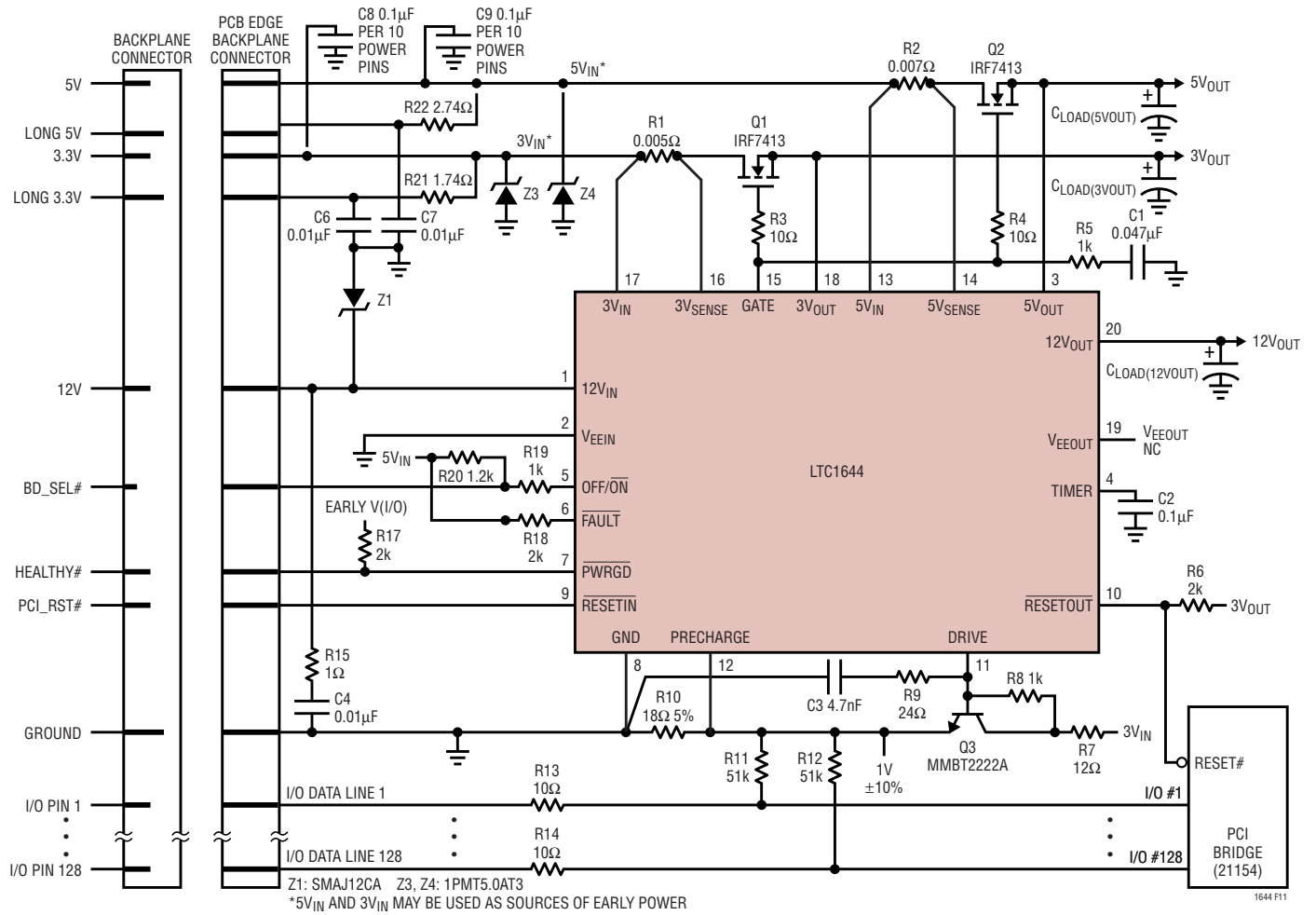

Figure 11. No V_{EE} (-12V) Supply Application Circuit

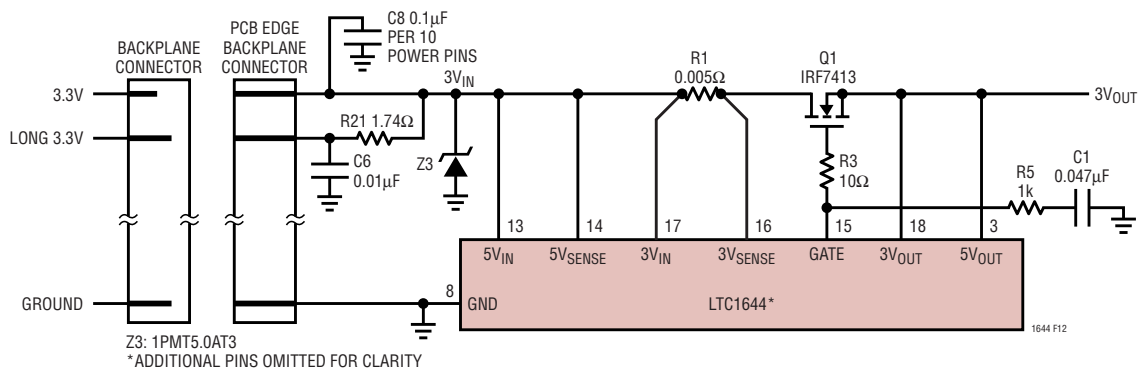

Figure 12. No 5V Supply Application Circuit

APPLICATIONS INFORMATION

sinusoidal response whose duration and period is dependent on the resonant circuit parameters. Since the absolute maximum supply voltage of the LTC1644 is 13.2V, transient protection against 12V_{IN} and V_{EEIN} supply voltage spikes and ringing is highly recommended.

In these applications, there are two methods for eliminating these supply voltage transients: using Zener diodes to clip the transient to a safe level and snubber networks. Snubber networks are series RC networks whose time constants are experimentally determined based on the board's parasitic resonant circuits. As a starting point, the capacitors in these networks are chosen to be 10× to 100× the power MOSFET's C_{OSS} under bias. The series resistor is a value determined experimentally and ranges from 1Ω to 50Ω, depending on the parasitic resonant circuit. Note

that in all LTC1644 circuit schematics, zener diodes and snubber networks have been added to the 12V_{IN} and V_{EEIN} (-12V) supply rail and should be used always. Since the absolute maximum supply voltage of the LTC1644 is 13.2V, snubber networks are not necessary on the 3V_{IN} or the 5V_{IN} supply lines. Zener diodes, however, are recommended as these devices provide large-scale transient protection for the LTC1644 against PCI backplane fault occurrences. All protection networks should be mounted very close to the LTC1644's supply voltage using short lead lengths to minimize lead inductance. This is shown schematically in Figures 15 and 16 and a recommended layout of the transient protection devices around the LTC1644 is shown in Figure 17.

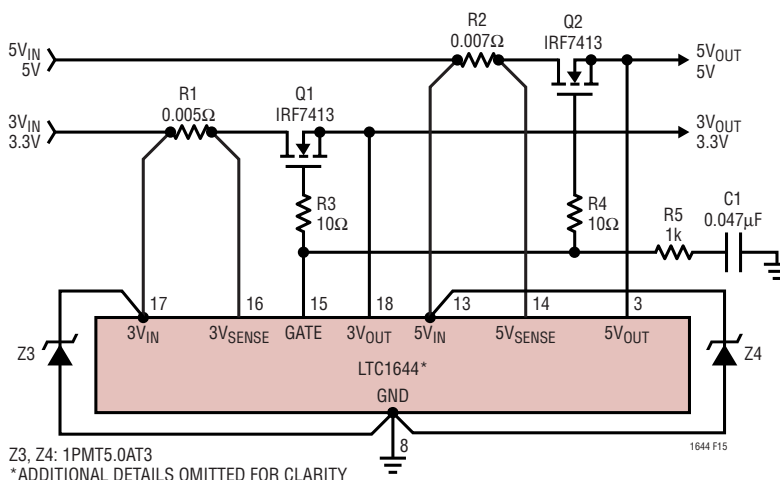

Figure 15. Place Transient Protection Devices Close to LTC1644's 5V_{IN} and 3V_{IN} Pins

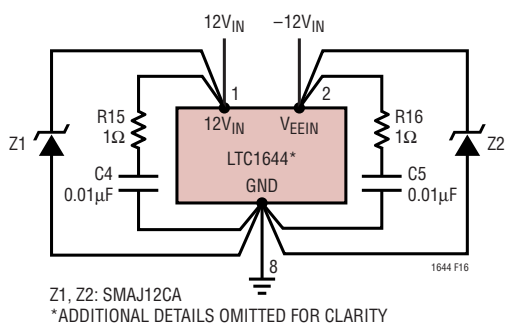

Figure 16. Place Transient Protection Devices Close to LTC1644's 12V_{IN} and V_{EEIN} Pins

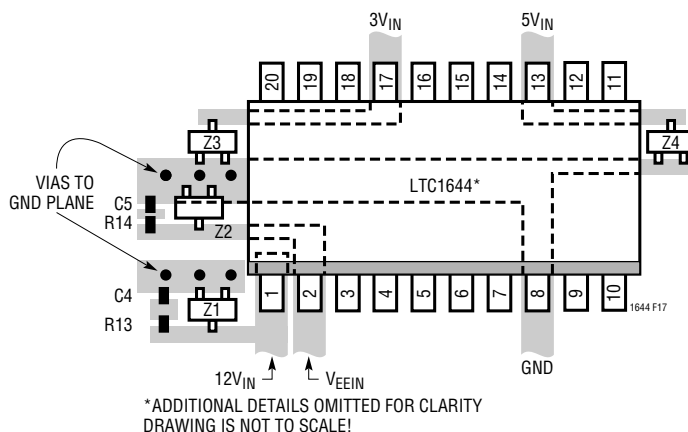

Figure 17. Recommended Layout for Transient Protection Components

APPLICATIONS INFORMATION

PCB Layout Considerations

For proper operation of the LTC1644's circuit breaker operation, 4-wire Kelvin-sense connections between the sense resistor and the LTC1644's $5V_{IN}$ and $5V_{SENSE}$ pins and $3V_{IN}$ and $3V_{SENSE}$ pins are strongly recommended. The PCB layout should be balanced and symmetrical to minimize wiring errors. In addition, the PCB layout for the sense resistors and the power MOSFETs should include good thermal management techniques for optimal device power dissipation.

A recommended PCB layout for the sense resistor, the power MOSFET and the GATE drive components around the LTC1644 is illustrated in Figure 18. In Hot Swap applications where load currents can be 10A, narrow PCB tracks exhibit more resistance than wider tracks and operate at more elevated temperatures. Since the sheet resistance of 1 ounce copper foil is approximately $0.45m\Omega/\square$, track resistances add up quickly in high current applications. Thus, to keep PCB track resistance and temperature rise to a minimum, the suggested trace width in these applications for 1 ounce copper foil is 0.03" for each ampere of DC current.

In the majority of applications, it will be necessary to use plated-through vias to make circuit connections from component layers to power and ground layers internal to the PC board. For 1 ounce copper foil plating, a general rule is 1 ampere of DC current per via, making sure the via is properly dimensioned so that solder completely fills any void. For other plating thicknesses, check with your PCB fabrication facility.

Power MOSFET and Sense Resistor Selection

Table 8 lists some current sense resistors that can be used the LTC1644's circuit breakers and Table 9 list some power MOSFET transistors that are available. Table 7 lists supplier web site addresses for discrete component mentioned throughout the LTC1644 data sheet.

Table 7. Manufacturers' Web Site

MANUFACTURER	WEB SITE
International Rectifier	www.irf.com
ON Semiconductor	www.onsemi.com
IRC-TT	www.irctt.com
Vishay-Dale	www.vishay.com
Vishay-Siliconix	www.vishay.com
Diodes, Inc.	www.diodes.com

Obtaining Information on Specific Parts

For more information regarding or to request a copy of the CompactPCI specification, contact the PCI Industrial Computer Manufacturers Group at:

PCI Industrial Computer Manufacturers Group
Wakefield, MA 01880 USA
Phone: 01 (617) 224-1100
Web Site: <http://www.picmg.com>

TransZorb SMAJ12CA and diodes BAV99 are supplied by:

Diodes, Incorporated
Westlake Village, CA 91362 USA
Phone: 01 (805) 446-4800
Web Site: <http://www.vishay-liteon.com> or
<http://www.diodes.com>

Transistors MMBT2222A and TVS 1PMT5.0AT3 are supplied by:

Semiconductor Components Industries, LLC
Phoenix, AZ 85008 USA
Phone: 01 (602) 244-6600
Web Site: <http://www.onsemi.com>

APPLICATIONS INFORMATION

Table 8. Sense Resistor Selection Guide

CURRENT LIMIT VALUE	PART NUMBER	DESCRIPTION	MANUFACTURER
1A	LR120601R055F WSL1206R055	0.055Ω, 0.5W, 1% Resistor	IRC-TT Vishay-Dale
2A	LR120601R028F WSL1206R028	0.028Ω, 0.5W, 1% Resistor	IRC-TT Vishay-Dale
5A	LR120601R011F WSL2010R011	0.011Ω, 0.5W, 1% Resistor	IRC-TT Vishay-Dale
7.6A	WSL2512R007	0.007Ω, 1W, 1% Resistor	Vishay-Dale
10A	WSL2512R005	0.005Ω, 1W, 1% Resistor	Vishay-Dale

Table 9. N-Channel Power MOSFET Selection Guide

CURRENT LEVEL (A)	PART NUMBER	DESCRIPTION	MANUFACTURER
0 to 2	MMDF3N02HD $R_{DS(ON)} = 0.1\Omega$	Dual N-Channel SO-8	ON Semiconductor
2 to 5	MMSF5N02HD $R_{DS(ON)} = 0.025\Omega$	Single N-Channel SO-8	ON Semiconductor
5 to 10	MTB50N06V $R_{DS(ON)} = 0.028\Omega$	Single N-Channel DD Pak	ON Semiconductor
5 to 10	IRF7413 $R_{DS(ON)} = 0.01\Omega$	Single N-Channel SO-8	International Rectifier
5 to 10	Si4410DY $R_{DS(ON)} = 0.01\Omega$	Single N-Channel SO-8	Vishay-Siliconix

PACKAGE DESCRIPTION

GN Package 20-Lead Plastic SSOP (Narrow .150 Inch) (Reference LTC DWG # 05-08-1641)

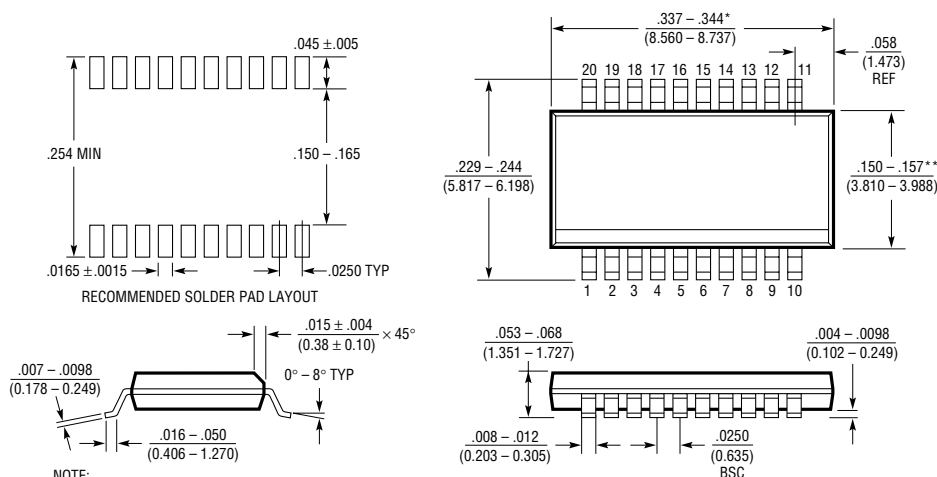

- NOTE:
1. CONTROLLING DIMENSION: INCHES
 2. DIMENSIONS ARE IN $\frac{\text{INCHES}}{\text{(MILLIMETERS)}}$
 3. DRAWING NOT TO SCALE
- * DIMENSION DOES NOT INCLUDE MOLD FLASH. MOLD FLASH SHALL NOT EXCEED 0.006" (0.152mm) PER SIDE
- ** DIMENSION DOES NOT INCLUDE INTERLEAD FLASH. INTERLEAD FLASH SHALL NOT EXCEED 0.010" (0.254mm) PER SIDE

GN20 (SSOP) 0502

APPLICATIONS INFORMATION

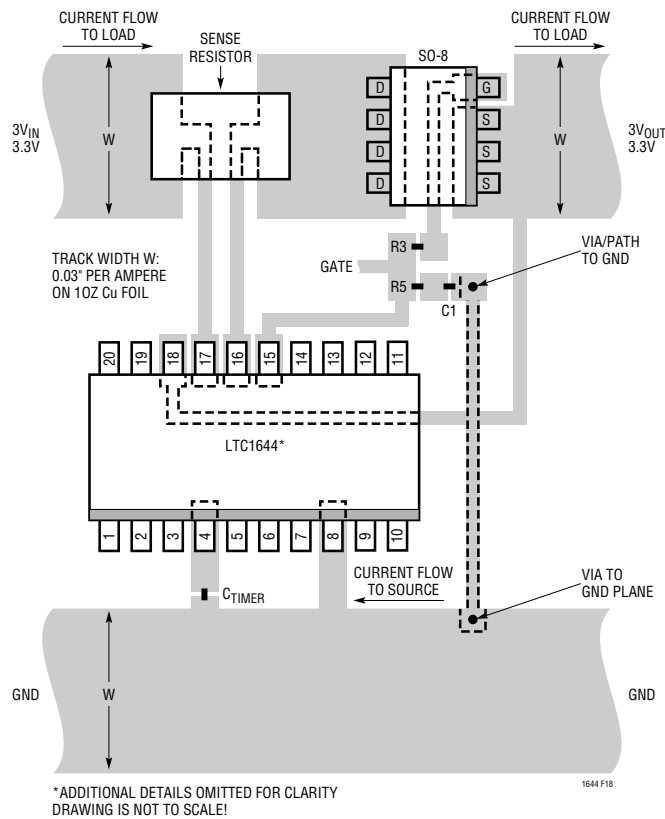

Figure 18. Recommended Layout for Power MOSFET, Sense Resistor and GATE Components for the 3.3V Rail

RELATED PARTS

PART NUMBER	DESCRIPTION	COMMENTS
LTC1421	Hot Swap Controller	Dual Supplies from 3V to 12V, Additionally -12V
LTC1422	Hot Swap Controller in SO-8	Single Supply from 3V to 12V, RESET Output
LT1640AL/LT1640AH	Negative Voltage Hot Swap Controllers in SO-8	Negative High Voltage Supplies from -10V to -80V
LT1641-1/LT1641-2	Positive Voltage Hot Swap Controller in SO-8	Supplies from 9V to 80V, Latch Off/Autoretry
LTC1642	Fault Protected Hot Swap Controller	3V to 15V, Overvoltage Protection Up to 33V
LTC1643AL/LTC1643AL-1/LTC1643AH	PCI Bus Hot Swap Controllers	3.3V, 5V, 12V, -12V Supplies for PCI Bus
LTC1645	2-Channel Hot Swap Controller	Operates from 1.2V to 12V, Power Sequencing
LTC1646	Dual CompactPCI Hot Swap Controller	3.3V, 5V Supplies Only, 1V Precharge, PCI Reset Logic
LTC1647	Dual Hot Swap Controller	Dual ON Pins for Supplies from 3V to 15V
LTC4211	Hot Swap Controller with Multifunction Current Control	Single Supply, 2.5V to 16.5V, MSOP
LTC4230	Triple Hot Swap Controller	1.7V to 16.5V Operation, Multifunction Current Control
LT4250	-48V Hot Swap Controller in SO-8	-20V to -80V, Active Current Limiting
LTC4251	-48V Hot Swap Controller in SOT-23	Floating Supply, Active Current Limiting and Fast Circuit Breaker

1644f