

Evaluation Board for SSM2317 Filterless Class-D Audio Amplifier

PACKAGE CONTENTS

SSM2317-EVALZ

OTHER SUPPORTING DOCUMENTATION

SSM2317 data sheet

GENERAL DESCRIPTION

The [SSM2317](#) is a fully integrated, single-chip, mono Class-D audio amplifier that is designed to maximize performance for mobile phone applications. The application circuit requires a minimum of external components and operates from a single 2.5 V to 5.5 V supply. It is capable of delivering 3 W of continuous output power with less than 1% THD + N driving a 3 Ω load from a single 5.0 V supply.

The SSM2317 is equipped with a differential mode input port and a high efficiency, full H-bridge at the output that enables direct coupling of the audio power signal to the loudspeaker. The differential mode input stage allows for cancelling of common-mode noise.

Automatic level control (ALC) can be activated to suppress clipping and improve dynamic range. This feature only requires one external resistor tied to GND via the VTH pin and an activation voltage on the ALC_EN pin. For setup configuration and sync operation, see the SSM2317 data sheet.

The part also features a high efficiency, low noise output modulation scheme that does not require external LC output filters when attached to an inductive load. The modulation provides high efficiency even at low output power. Filterless operation also helps to decrease distortion due to the nonlinearities of output LC filters.

This user guide describes how to configure and use the SSM2317 evaluation board to evaluate the SSM2317. It is recommended that this data sheet be read in conjunction with the SSM2317 data sheet, which provides more detailed information about the specifications, internal block diagrams, and application guidance for the amplifier IC.

EVALUATION BOARD OVERVIEW

The SSM2317 evaluation board carries a complete application circuit for driving a loudspeaker. Figure 1 shows the top view of the evaluation board, and Figure 2 shows the bottom view.



Figure 1. SSM2317 Evaluation Board Top View

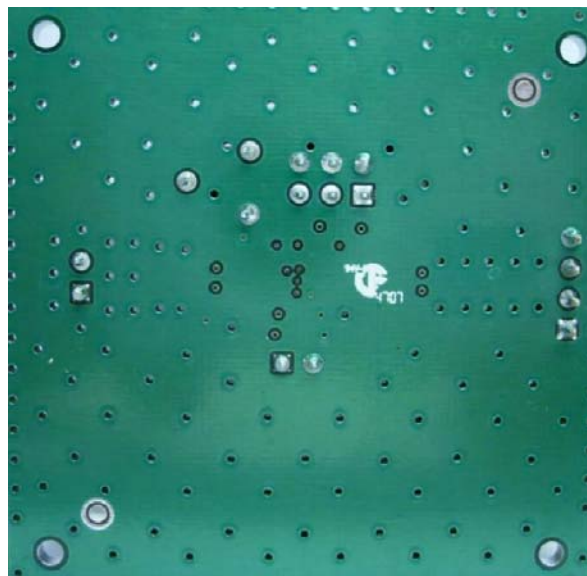

Figure 2. SSM2317 Evaluation Board Bottom View

TABLE OF CONTENTS

Package Contents.....	1	Output Configuration.....	3
Other Supporting Documentation.....	1	Power Supply Configuration	3
General Description	1	Component Selection	3
Evaluation Board Overview	1	Getting Started.....	4
Revision History	2	What to Test	4
Setting Up the Evaluation Board	3	Evaluation Board Schematic and Artwork.....	5
Input Configuration	3	Ordering Information.....	8
Operation Mode Configuration	3	Bill of Materials.....	8

REVISION HISTORY

10/10—Revision 0: Initial Version

SETTING UP THE EVALUATION BOARD

INPUT CONFIGURATION

A 4-pin header (J1) on the middle left side of the board feeds the audio signal into the board (see Figure 1). If the input audio signal is differential (IN+ and IN-), three pins of J1 are used for IN+, IN-, and signal ground. For a single-ended audio input, only two pins of J1 are used. One is for the signal ground and the other is for either IN+ or IN-. If IN+ is used, place a jumper between Pin 3 and Pin 4 of J1, shorting IN- to ground. If IN- is used, place the jumper between Pin 1 and Pin 2 of J1, connecting IN+ to ground.

OPERATION MODE CONFIGURATION

The 6-pin header, J2, is used to turn on/off the SSM2317 amplifier and configure the ALC operation modes. Placing a jumper across Pin 1 and Pin 2 of J2 shuts down the SSM2317 so that only a minimum current (about 20 nA) is drawn from the power supply (when R3 is shorted). Removing the jumper puts the SSM2317 in normal operation. Placing a jumper across Pin 3 and Pin 4 of J2 disables ALC mode, while removing the jumper activates ALC mode. When ALC is disabled, the SSM2317 behaves like a traditional amplifier with a fixed 18 dB. Placing a jumper across Pin 5 and Pin 6 of J2 shorts across the ALC threshold resistor (on board) and sets a maximum limiter level of 90% of V_{DD} (when ALC is activated).

OUTPUT CONFIGURATION

The output connector, J4, is located on the right side of the board (see Figure 1). J4 drives a loudspeaker whose impedance should be no less than 3 Ω .

Although the SSM2317 does not require any external LC output filters due to a low noise modulation scheme, if the speaker length is >10 cm, it is recommended to put a ferrite bead (L1 and L2) near each output pin of the SSM2317 to reduce electromagnetic interference (EMI), as shown in the schematic in Figure 3. Some users may want to replace the ferrite beads with these inductors to evaluate applications with specific EMI vs. audio performance constraints. As an aid, a properly tuned ferrite bead-based EMI filter is assembled at the output terminals of the device.

For optimal performance, as specified in the SSM2317 data sheet (in particular, for THD and SNR), remove the entire EMI filter, short across the ferrite bead terminals, and open the capacitor terminals.

POWER SUPPLY CONFIGURATION

The evaluation board schematic is shown in Figure 3. The 2-pin header, J3, must be used to power the board. Care must be taken to connect the dc power with correct polarity and voltage. The positive voltage terminal of J3 (VDD) is indicated with an arrow in Figure 1.

Polarity and Voltage

The wrong power supply polarity or an overvoltage may damage the board permanently. The maximum peak current is approximately 0.33 A when driving an 8 Ω load and when the input voltage is 5 V.

COMPONENT SELECTION

Selecting the proper components is the key to achieving the performance required at the cost budgeted.

ALC Threshold Setting Resistor—R5

When ALC mode is active, the maximum output amplitude threshold (V_{TH}) during the limiting operation can be adjusted from 90% to 45% of V_{DD} by inserting an external resistor, R_{TH} , between the VTH pin and GND. Shorting the VTH pin to GND sets V_{TH} to 90% of V_{DD} . Leaving the VTH pin unconnected sets V_{TH} to 45% of V_{DD} . The relation of R_{TH} to V_{TH} is shown by the following equation:

$$V_{TH} = 0.9 \times \frac{50 \text{ k}\Omega + R_{TH}}{50 \text{ k}\Omega + 2 \times R_{TH}} \times V_{DD}$$

Maximum output power is derived from V_{TH} by the following equation:

$$P_{OUT} = \frac{\left(\frac{V_{TH}}{\sqrt{2}}\right)^2}{R_{SP}}$$

where R_{SP} is the speaker impedance.

To tune a variety of V_{TH} levels, a potentiometer, R5, is mounted on the evaluation board. To measure the potentiometer resistance setting, insert an ohmmeter across Pin 5 and Pin 6 of J2.

Note that measuring the resistance across the potentiometer is not adequate to determine the actual R_{TH} value. This is due to the internal input resistance of 50 k Ω at the VTH pin. The user must take into account the internal resistance while evaluating actual R_{TH} . For example, after tuning R5 to a desirable level, the user measures the resistance from Pin 5 and Pin 6 of J2. Then, to infer the actual R_{TH} , use this simple calculation:

$$\frac{1}{R_{Threshold}} = \frac{1}{R_{Measured}} - \frac{1}{50 \text{ k}\Omega}$$

where:

$R_{Threshold}$ is the desired external resistor value from the VTH pin to GND.

$R_{Measured}$ is the measured resistance from the VTH pin to GND.

Input Coupling Capacitor Selection—C1 and C2

The input coupling capacitors, C1 and C2, should be large enough to couple the low frequency signal components in the incoming signal but small enough to filter out unnecessary low frequency signals. For music signals, the cutoff frequency chosen is, typically, between 20 Hz and 30 Hz. The value of the input capacitor is calculated by

$$C = 1/(2\pi Rf_c)$$

where:

$R = 40 \text{ k}\Omega + R_{ext}$ (the external resistor used to fine-tune the desired gain; on the schematics (see Figure 3), this is the $0 \text{ }\Omega$ resistor at the input pins).

f_c is the cutoff frequency.

Output Ferrite Beads—L1 and L2

The output beads, L1 and L2, are necessary components for filtering out the EMI caused at the switching output nodes when the length of the speaker wire is greater than 10 cm. The penalty for using ferrite beads for EMI filtering is slightly worse noise and distortion performance at the system level due to the nonlinearity of the beads.

Ensure that these beads have enough current-conducting capability while providing sufficient EMI attenuation. The current rating needed for an $8 \text{ }\Omega$ load is approximately 420 mA, and impedance at 100 MHz should be $\geq 120 \text{ }\Omega$. In addition, the lower the dc resistance (DCR) of these beads is, the better for minimizing their power consumption. Table 1 describes the recommended beads.

Output Shunting Capacitors

There are two output shunting capacitors, C6 and C7, that work with the ferrite beads, L1 and L2. Use small size (0603 or 0402), multilayer ceramic capacitors that are made of X7R or COG (NPO) materials. Note that the capacitors can be used in pairs: a capacitor with small capacitance (up to 100 pF) plus a capacitor with a bigger capacitance (less than 1 nF). This configuration provides thorough EMI reduction for the entire frequency spectrum. For BOM cost reduction and capable performance, a single capacitor of approximately 470 pF can be used.

Table 1. Recommended Output Beads

Part No.	Manufacturer	Z (Ω)	I _{MAX} (mA)	DCR (Ω)	Size (mm)
BLM18PG121SN1D	Murata	120	2000	0.05	1.6 × 0.8 × 0.8
MPZ1608S101A	TDK	100	3000	0.03	1.6 × 0.8 × 0.8
MPZ1608S221A	TDK	220	2000	0.05	1.6 × 0.8 × 0.8
BLM18EG221SN1D	Murata	220	2000	0.05	1.6 × 0.8 × 0.8

Table 2. Recommended Output Inductors

Part No.	Manufacturer	L (μH)	I _{MAX} (mA)	DCR (Ω)	Size (mm)
LQM31PNR47M00	Murata	0.47	1400	0.07	3.2 × 1.6 × 0.85
LQM31PN1R0M00	Murata	1.0	1200	0.12	3.2 × 1.6 × 0.85
LQM21PNR47MC0	Murata	0.47	1100	0.12	2.0 × 1.25 × 0.5
LQM21PN1R0MC0	Murata	1.0	800	0.19	2.0 × 1.25 × 0.5
LQH32CN2R2M53	Murata	2.2	790	0.1	3.2 × 2.5 × 1.55

Output Inductors

If using inductors for the purpose of EMI filtering at the output nodes, choose inductance that is $< 2.2 \text{ }\mu\text{H}$ for these inductors. The higher the inductance is, the lower the EMI becomes at the output. However, the cost and power consumption by the inductors are higher. Using $0.47 \text{ }\mu\text{H}$ to $2.2 \text{ }\mu\text{H}$ inductors is recommended, and the current rating needs $> 600 \text{ mA}$ (saturation current) for an $8 \text{ }\Omega$ load. Table 2 shows the recommended inductors. Note that these inductors are not populated on the evaluation board.

GETTING STARTED

To ensure proper operation, carefully follow Step 1 through Step 7.

1. If a jumper is across Pin 1 and Pin 2 of J2, remove the jumper to enable the amplifier.
2. Remove the jumper across Pin 3 and Pin 4 of J2 to ensure that the device is in ALC mode. To put in standard 12 dB configuration and disable ALC, insert a jumper across Pin 3 and Pin 4.
3. For most audio quality testing, the EMI filtering (L1/L2 and C6/C7) must be removed. Short across the L1 and L2 terminals to make a direct connection from the device output to the J4 speaker header.
4. Connect the load to the audio output connector, J4.
5. Connect the audio input to the board in either differential mode or single-ended mode, depending on the application.
6. Connect the power supply with the proper polarity and voltage.
7. Turn R5 potentiometer to the desired V_{TH} setting.

WHAT TO TEST

- Electromagnetic interference (EMI)—connect wires for the speakers, making sure that they are the same length as the wires required for the actual application environment; then complete the EMI test.
- Signal-to-noise ratio.
- Output noise—make sure to use an A-weighted filter to filter the output before reading the measurement meter.
- Maximum output power.
- Distortion.
- Efficiency.

EVALUATION BOARD SCHEMATIC AND ARTWORK

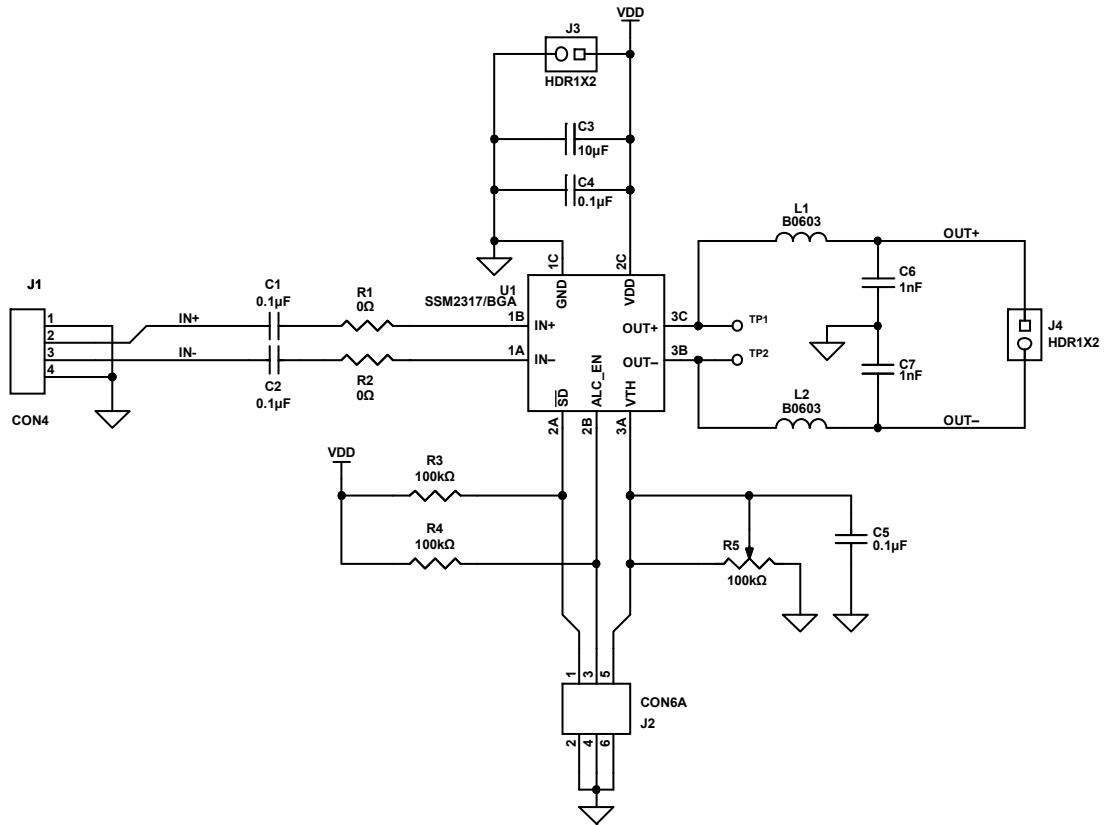
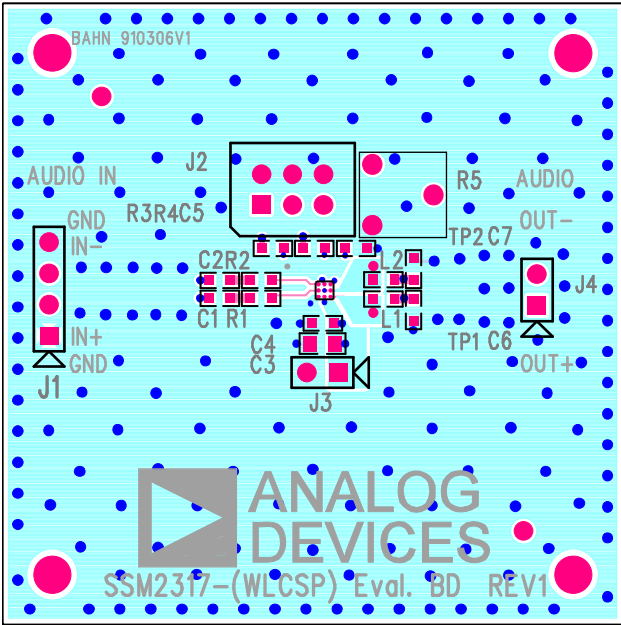

Figure 3. Schematic of the SSM2317 Evaluation Board

08354-003



09354-004

Figure 4. Top Layer with Top Silkscreen

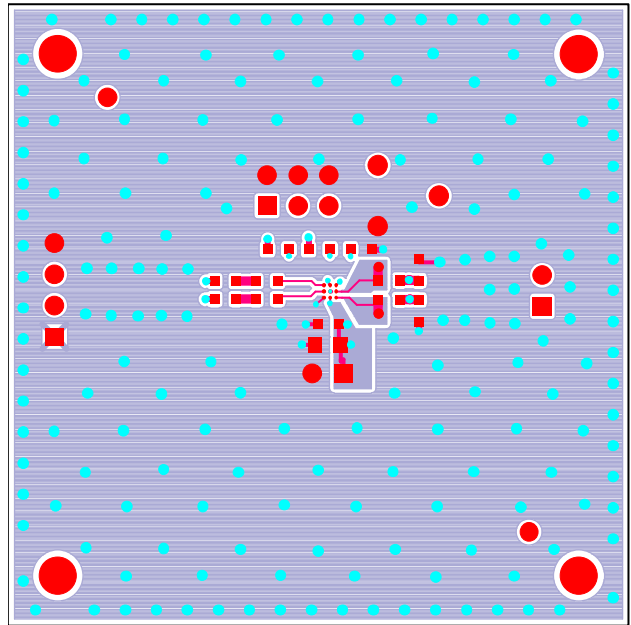

09354-006

Figure 6. Top Layer

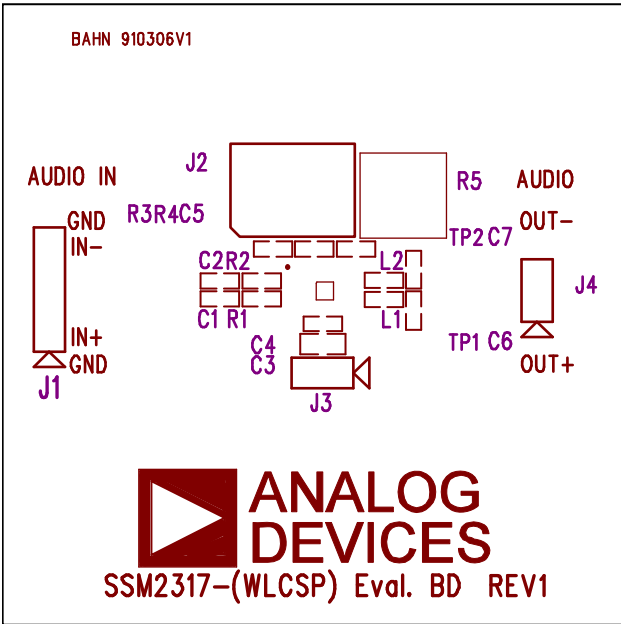

09354-005

Figure 5. Top Silkscreen

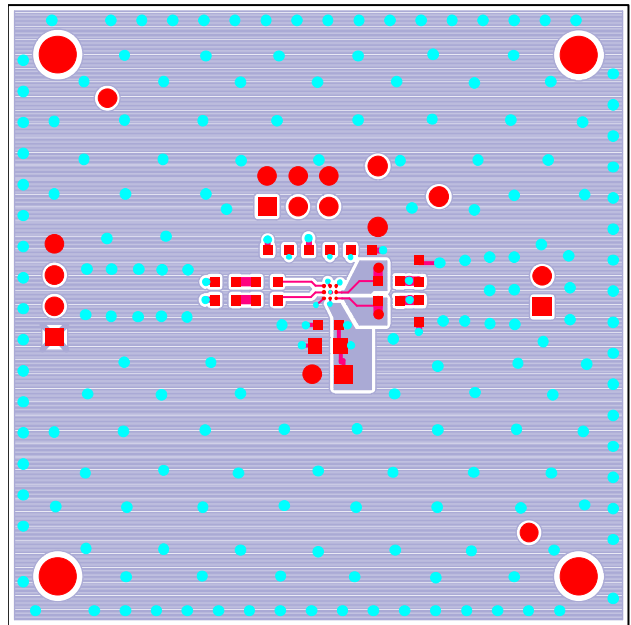

09354-006

Figure 7. Layer 2 (Ground Plane)

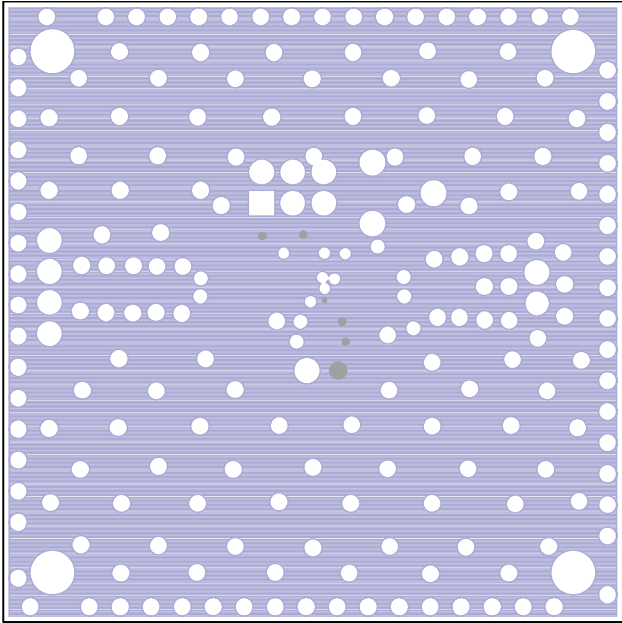

09354-008

Figure 8. Layer 3 (Power Plane)

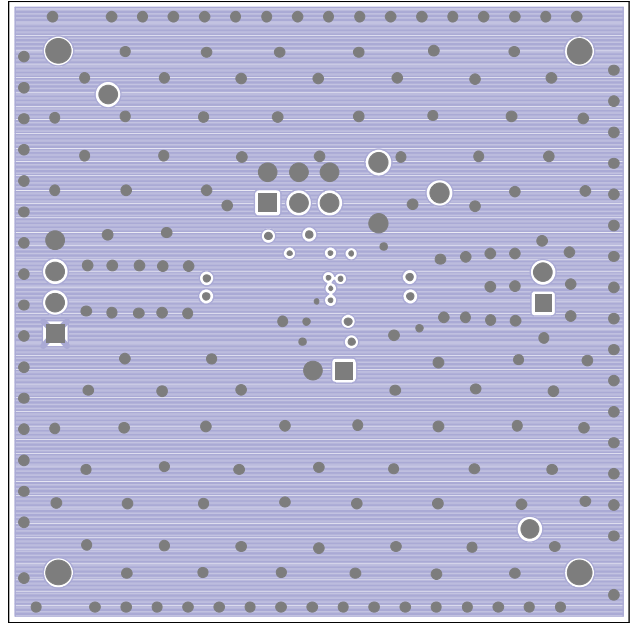

09354-009

Figure 9. Bottom Layer

ORDERING INFORMATION

BILL OF MATERIALS

Table 3.

Qty	Reference Designator	Description	Supplier/Part No.
3	C1, C2, C4	Ceramic capacitor, 0.1 μ F	Panasonic, ECJ-ZEB1A104M
1	C3	Ceramic capacitor, 10 μ F, 10 V	Murata, GRM31MF51A106ZA01L
2	C6, C7	Ceramic capacitor, 1 nF, 10%, 50 V	Kemet, C0603C102J5GACTU
1	J1	CON4, header connector	Tyco, 640452-4
1	J2	CON6A, six-position header connector	Tyco, 3-87589-6
2	J3, J4	HDR1X2 header connector	Tyco, 640452-2
2	L1, L2	Ferrite chip, B0603, 220 Ω	TDK, MPZ1608S221A
2	R1, R2	Resistor, 0 Ω	Panasonic, ERJ-3GEY0R00V
2	R3, R4	Resistor, 100 k Ω	Yageo, RT0603FRE07100KL
2	TP1, TP2	Test pad	N/A
1	U1	SSM2317/BGA	Analog Devices, SSM2317
1	C5	Ceramic capacitor, 0.1 μ F	Panasonic, ECJ-ZEB1A104M
1	R5	Potentiometer, 100 k Ω to 0 Ω	Panasonic, EVN-D8AA03B15

**ESD Caution**

ESD (electrostatic discharge) sensitive device. Charged devices and circuit boards can discharge without detection. Although this product features patented or proprietary protection circuitry, damage may occur on devices subjected to high energy ESD. Therefore, proper ESD precautions should be taken to avoid performance degradation or loss of functionality.

Legal Terms and Conditions

By using the evaluation board discussed herein (together with any tools, components documentation or support materials, the "Evaluation Board"), you are agreeing to be bound by the terms and conditions set forth below ("Agreement") unless you have purchased the Evaluation Board, in which case the Analog Devices Standard Terms and Conditions of Sale shall govern. Do not use the Evaluation Board until you have read and agreed to the Agreement. Your use of the Evaluation Board shall signify your acceptance of the Agreement. This Agreement is made by and between you ("Customer") and Analog Devices, Inc. ("ADI"), with its principal place of business at One Technology Way, Norwood, MA 02062, USA. Subject to the terms and conditions of the Agreement, ADI hereby grants to Customer a free, limited, personal, temporary, non-exclusive, non-sublicensable, non-transferable license to use the Evaluation Board FOR EVALUATION PURPOSES ONLY. Customer understands and agrees that the Evaluation Board is provided for the sole and exclusive purpose referenced above, and agrees not to use the Evaluation Board for any other purpose. Furthermore, the license granted is expressly made subject to the following additional limitations: Customer shall not (i) rent, lease, display, sell, transfer, assign, sublicense, or distribute the Evaluation Board; and (ii) permit any Third Party to access the Evaluation Board. As used herein, the term "Third Party" includes any entity other than ADI, Customer, their employees, affiliates and in-house consultants. The Evaluation Board is NOT sold to Customer; all rights not expressly granted herein, including ownership of the Evaluation Board, are reserved by ADI. CONFIDENTIALITY. This Agreement and the Evaluation Board shall all be considered the confidential and proprietary information of ADI. Customer may not disclose or transfer any portion of the Evaluation Board to any other party for any reason. Upon discontinuation of use of the Evaluation Board or termination of this Agreement, Customer agrees to promptly return the Evaluation Board to ADI. ADDITIONAL RESTRICTIONS. Customer may not disassemble, decompile or reverse engineer chips on the Evaluation Board. Customer shall inform ADI of any occurred damages or any modifications or alterations it makes to the Evaluation Board, including but not limited to soldering or any other activity that affects the material content of the Evaluation Board. Modifications to the Evaluation Board must comply with applicable law, including but not limited to the RoHS Directive. TERMINATION. ADI may terminate this Agreement at any time upon giving written notice to Customer. Customer agrees to return to ADI the Evaluation Board at that time. LIMITATION OF LIABILITY. THE EVALUATION BOARD PROVIDED HEREUNDER IS PROVIDED "AS IS" AND ADI MAKES NO WARRANTIES OR REPRESENTATIONS OF ANY KIND WITH RESPECT TO IT. ADI SPECIFICALLY DISCLAIMS ANY REPRESENTATIONS, ENDORSEMENTS, GUARANTEES, OR WARRANTIES, EXPRESS OR IMPLIED, RELATED TO THE EVALUATION BOARD INCLUDING, BUT NOT LIMITED TO, THE IMPLIED WARRANTY OF MERCHANTABILITY, TITLE, FITNESS FOR A PARTICULAR PURPOSE OR NON-INFRINGEMENT OF INTELLECTUAL PROPERTY RIGHTS. IN NO EVENT WILL ADI AND ITS LICENSORS BE LIABLE FOR ANY INCIDENTAL, SPECIAL, INDIRECT, OR CONSEQUENTIAL DAMAGES RESULTING FROM CUSTOMER'S POSSESSION OR USE OF THE EVALUATION BOARD, INCLUDING BUT NOT LIMITED TO LOST PROFITS, DELAY COSTS, LABOR COSTS OR LOSS OF GOODWILL. ADI'S TOTAL LIABILITY FROM ANY AND ALL CAUSES SHALL BE LIMITED TO THE AMOUNT OF ONE HUNDRED US DOLLARS (\$100.00). EXPORT. Customer agrees that it will not directly or indirectly export the Evaluation Board to another country, and that it will comply with all applicable United States federal laws and regulations relating to exports. GOVERNING LAW. This Agreement shall be governed by and construed in accordance with the substantive laws of the Commonwealth of Massachusetts (excluding conflict of law rules). Any legal action regarding this Agreement will be heard in the state or federal courts having jurisdiction in Suffolk County, Massachusetts, and Customer hereby submits to the personal jurisdiction and venue of such courts. The United Nations Convention on Contracts for the International Sale of Goods shall not apply to this Agreement and is expressly disclaimed.