



# SINGLE PRESSURE SENSOR DATASHEET

The single pressure sensor gives you an analog read that maps to force on the sensor. The more you press, the lower the resistance goes, perfect for on-body pressure related sensing like ribcage expansion for breathing. This sensor is small but mighty, making it convenient for small surface area applications.

**MATERIALS:**  
 INSULATION: THERMOPLASTIC POLYURETHANE  
 INNER CONDUCTOR: PROPRIETARY  
 INTERCONNECT : ENIG FLEX PCB  
 PRESSURE SENSITIVE MATERIAL: PROPRIETARY

**DATA:**  
 BEND RADIUS LIMITATION: NONE  
 THICKNESS: APPROX 20 MILS  
 OPERATING VOLTAGE RANGE: 3.7V-5V  
 PRESSURE RANGE: .5LBS - 10LBS  
 COMPONENT DIMENSIONS: 2" X 1"  
 SENSING AREA DIMENSIONS: .75" X .75"

## PINOUT:

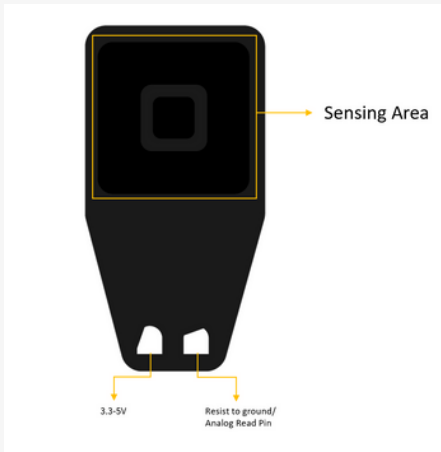

## OPERATING NOTES:

- DO NOT WASH
- DO NOT CUT
- DO NOT DISASSEMBLE
- DO NOT SEW
- DO NOT EXPOSE TO TEMPERATURES ABOVE 150 DEGREES F
- NOT REUSABLE - STICKING AND DE-STICKING OR DESOLDERING WILL CAUSE DAMAGE
- FOR PROTOTYPING ONLY. ALL DATA IS APPROXIMATE AND THESE PARTS ARE NOT DESIGNED FOR PRODUCTION USE.
- USE CARE WHEN SOLDERING. LONG EXPOSURE TO HEAT WILL CAUSE DELAMINATION
- DO NOT SOLDER ON TOP OF A TEXTILE
- DO NOT USE AS A "LEVER" TO REMOVE THE PART FROM A BREADBOARD. IF USING WITH HEADERS, HOLD THE HEADERS TO DETACH.

## RESISTANCE VS PRESSURE

GRAMS OF FORCE	RESISTANCE (IN OHMS)
150	180,000
200	70,000
250	27,000
300	18,000
350	15,000
400	13,000
450	13,500
500	13,000
6350	1,000
10,886	600
13,607	300

**RECOMMENDED OPERATING RANGE**

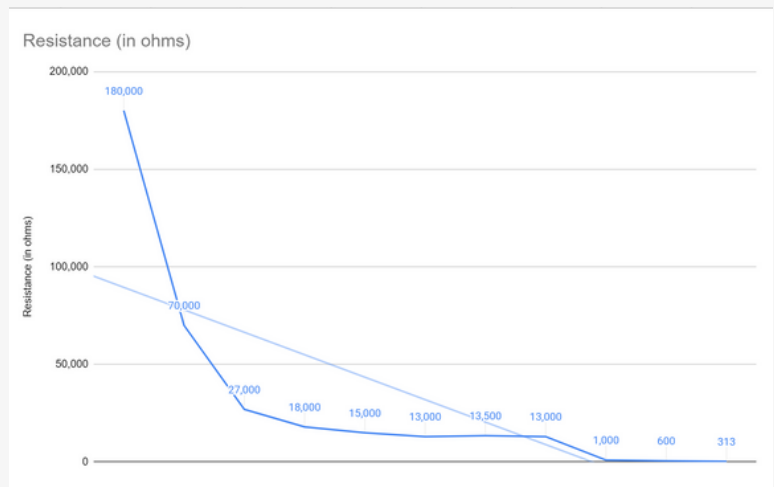

- **Our parts are produced by hand. There can be significant variation between units. Please use this data only as a reference, as your part's exact values may differ.**



# DOUBLE BACKLIT USER INTERFACE DATASHEET

The double backlit button is like the single backlit button, but twice the fun! Use this part if you need to control something up and down, or right to left. Using cut-out vinyl, you can create icons and decals on fabric that show your users the button functionalities.

**MATERIALS:**  
INSULATION: THERMOPLASTIC POLYURETHANE  
INNER CONDUCTOR: PROPRIETARY  
INTERCONNECT : ENIG FLEX PCB

**DOUBLE BACKLIT USER INTERFACE**  
BEND RADIUS LIMITATION: .5" AROUND BUTTON AREA  
THICKNESS: APPROX 1MM AT BUTTON  
OPERATING VOLTAGE RANGE: 5V  
COMPONENT DIMENSIONS: 4.6" X 6.3"  
BUTTON DIMENSIONS: 1" DIAMETER CIRCLE  
DURABILITY: 10,000 PRESSES UNDER 5LBF

## PINOUT:

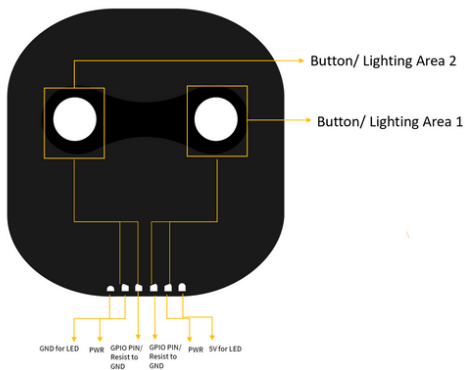

## USE SUGGESTION

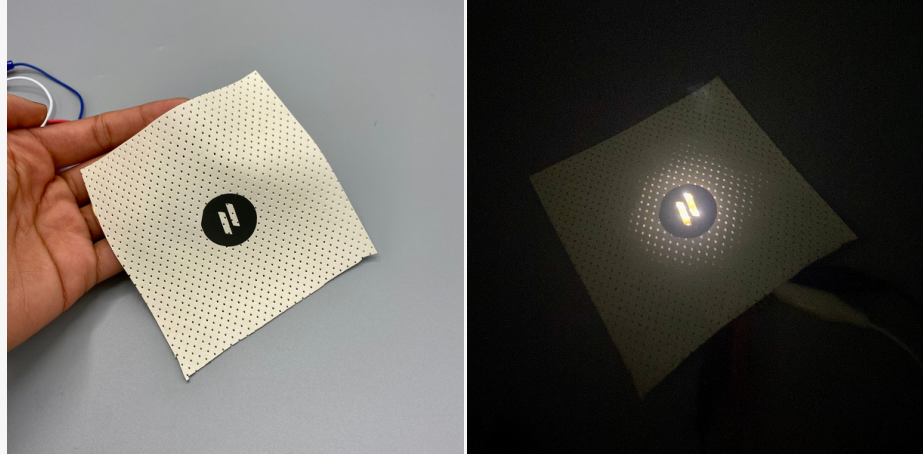

**TIP: Use a cut-out vinyl sticker or other kind of mask to make backlit logos from your button.**

## OPERATING NOTES:

- DO NOT WASH
- DO NOT CUT
- DO NOT DISASSEMBLE
- DO NOT SEW
- DO NOT EXPOSE TO TEMPERATURES ABOVE 150 DEGREES F
- NOT REUSABLE - STICKING AND DE-STICKING OR DESOLDERING WILL CAUSE DAMAGE
- FOR PROTOTYPING ONLY. ALL DATA IS APPROXIMATE AND THESE PARTS ARE NOT DESIGNED FOR PRODUCTION USE.
- USE CARE WHEN SOLDERING. LONG EXPOSURE TO HEAT WILL CAUSE DELAMINATION
- DO NOT SOLDER ON TOP OF A TEXTILE

- Our parts are produced by hand. There can be significant variation between units. Please use this data only as a reference, as your part's exact values may differ.



# MINI PRESSURE MATRIX DATASHEET

If you are looking to map pressure over a 1.25" area, this is the one. Our 3x3 mini pressure matrix has 6 leads, allowing you to map which point you are at in the 3x3 matrix. Each area has an analog readout that varies depending on the weight of the item on the pressure sensor. Generally, sensor values will read from 500Kohms to 100ohms depending on the force put onto the sensor.

**MATERIALS:**  
 INSULATION: THERMOPLASTIC POLYURETHANE  
 INNER CONDUCTOR: PROPRIETARY  
 INTERCONNECT : ENIG FLEX PCB  
 PRESSURE SENSITIVE MATERIAL: PROPRIETARY

**MINI PRESSURE MATRIX**  
 BEND RADIUS LIMITATION: NONE  
 THICKNESS: APPROX 20 MILS  
 OPERATING VOLTAGE RANGE: 3.7V-5V  
 PRESSURE RANGE: .2LBS - 10LBS  
 COMPONENT DIMENSIONS: 2.3" X 3"  
 SENSING AREA DIMENSIONS: 1.25" X 1.25"

## PINOUT:

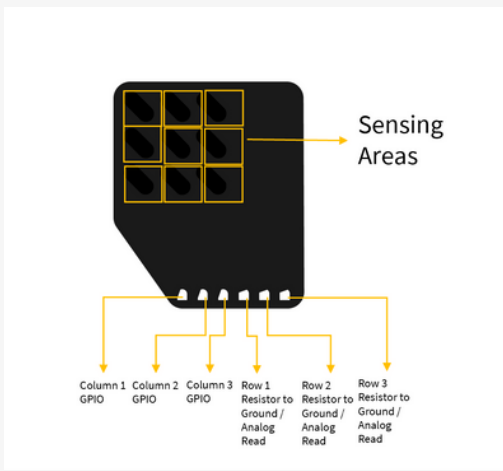

## OPERATING NOTES:

- DO NOT WASH
- DO NOT CUT
- DO NOT DISASSEMBLE
- DO NOT SEW
- DO NOT EXPOSE TO TEMPERATURES ABOVE 150 DEGREES F
- NOT REUSABLE - STICKING AND DE-STICKING OR DESOLDERING WILL CAUSE DAMAGE
- FOR PROTOTYPING ONLY. ALL DATA IS APPROXIMATE AND THESE PARTS ARE NOT DESIGNED FOR PRODUCTION USE.
- USE CARE WHEN SOLDERING. LONG EXPOSURE TO HEAT WILL CAUSE DELAMINATION
- DO NOT SOLDER ON TOP OF A TEXTILE

## RESISTANCE VS PRESSURE FOR EACH MATRIX SQUARE

GRAMS OF FORCE	RESISTANCE (IN OHMS)	RECOMMENDED OPERATING RANGE
150	180,000	
200	70,000	
250	27,000	
300	18,000	
350	15,000	
400	13,000	
450	13,500	
500	13,000	
6350	1,000	
10,886	600	
13,607	300	

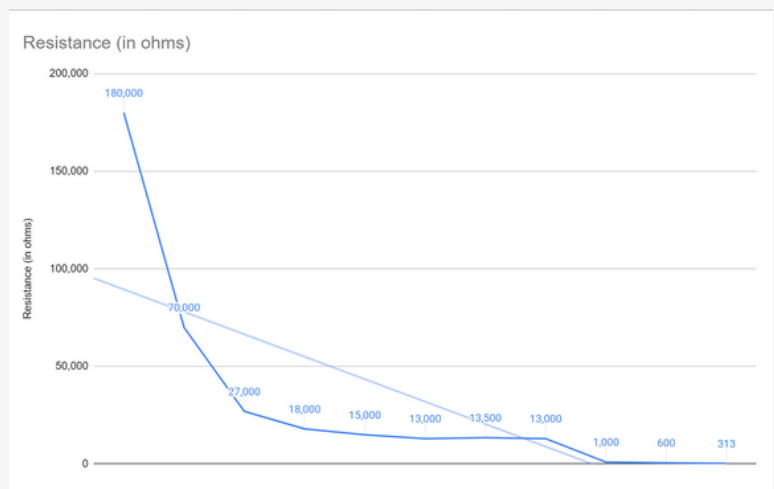

- Our parts are produced by hand. There can be significant variation between units. Please use this data only as a reference, as your part's exact values may differ.

# BUSES DATASHEET

## MATERIALS:

INSULATION: THERMOPLASTIC POLYURETHANE  
INNER CONDUCTOR: PROPRIETARY METAL  
INTERCONNECT : ENIG FLEX PCB

## OPERATING NOTES:

- DO NOT WASH
- DO NOT CUT
- DO NOT DISASSEMBLE
- DO NOT SEW
- DO NOT EXPOSE TO TEMPERATURES ABOVE 150 DEGREES F
- NOT REUSABLE - STICKING AND DE-STICKING OR DESOLDERING WILL CAUSE DAMAGE
- FOR PROTOTYPING ONLY. ALL DATA IS APPROXIMATE AND THESE PARTS ARE NOT DESIGNED FOR PRODUCTION USE.
- USE CARE WHEN SOLDERING. LONG EXPOSURE TO HEAT WILL CAUSE DELAMINATION
- DO NOT SOLDER ON TOP OF A TEXTILE

- **Our parts are produced by hand. There can be significant variation between units. Please use this data only as a reference, as your part's exact values may differ.**

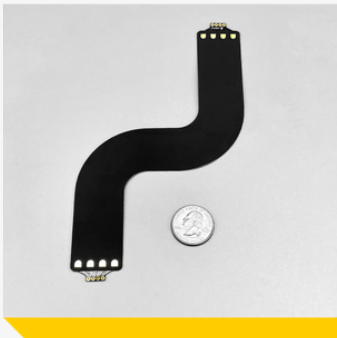

### S-CURVE BUS

BEND RADIUS LIMITATION: NONE  
THICKNESS: APPROX. 10 MILS  
MAX CURRENT PER TRACE: 1A  
COMPONENT DIMENSIONS: 4" X 6"  
RESISTANCE PER TRACE: < 1 OHM

The S-bus is perfect for when you need to make an unusual geometry from our LEL buses. You can use two together to make a big C curve to go around an elbow, or just use one to route wiring where you need it for soft robotics or for an installation.



### C-CURVE BUS

BEND RADIUS LIMITATION: NONE  
THICKNESS: APPROX. 10 MILS  
MAX CURRENT PER TRACE: 1A  
COMPONENT DIMENSIONS: 4" X 3"  
RESISTANCE PER TRACE: < 1 OHM

The C-Curve bus is perfect for connecting two .15" buses together at a wide angle. Try using this part for creating conductive lines over shoulders or over large surface areas.



### 4-WIRE BUS

BEND RADIUS LIMITATION: NONE  
THICKNESS: APPROX. 10 MILS  
MAX CURRENT PER TRACE: 1A  
COMPONENT DIMENSIONS: 1.5" X 12"  
RESISTANCE PER TRACE: < 1 OHM

The straight 4-wire bus has 4 leads that are each .15" wide. Each "wire" is super low resistance, giving you fast data speed and solid wattage without heating up. Each bus is twistable, drapable and bendable for all of your soft circuit needs and this bus can be easily soldered to the S-curve bus or obtuse angle bus to make different shapes of traces for wearable tech applications.

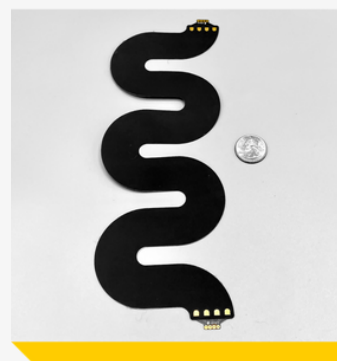

### SERPENTINE BUS

BEND RADIUS LIMITATION: NONE  
THICKNESS: APPROX. 10 MILS  
MAX CURRENT PER TRACE: 1A  
COMPONENT DIMENSIONS: 3" X 10"  
RESISTANCE PER TRACE: < 2 OHM  
ELONGATION: UP TO 20%

This serpentine has .15" traces making it compatible with our S-curve and obtuse bus samples. Use this bus when you need a little more stretch as it has up to 10% elongation. We suggest this bus for our pressure sensors



# MEGA PRESSURE MATRIX DATASHEET

Like the mini pressure sensor... but bigger! Our 3x3 mega pressure matrix has 6 leads, allowing you to map which point you are at in the 3x3 matrix and get a pressure mapping over a surface. Each area has an analog readout that varies depending on the weight of the item on the pressure sensor. Generally, sensor values will read from 500Kohms to 100ohms depending on the force put onto the sensor.

**MATERIALS:**  
 INSULATION: THERMOPLASTIC POLYURETHANE  
 INNER CONDUCTOR: PROPRIETARY  
 INTERCONNECT : ENIG FLEX PCB  
 PRESSURE SENSITIVE MATERIAL: PROPRIETARY

**DATA:**  
 BEND RADIUS LIMITATION: NONE  
 THICKNESS: APPROX 20MILS  
 OPERATING VOLTAGE RANGE: 3.7V-5V  
 PRESSURE RANGE: 0.2LBS - 10LBS  
 COMPONENT DIMENSIONS: 5" X 6.5"  
 SENSING AREA DIMENSIONS: 3" X 3"

## PINOUT:

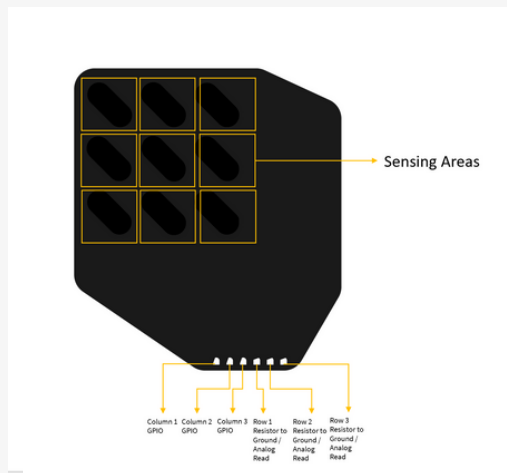

## OPERATING NOTES:

- DO NOT WASH
- DO NOT CUT
- WHEN USED WITH DO NOT DISASSEMBLE
- DO NOT SEW
- DO NOT EXPOSE TO TEMPERATURES ABOVE 150 DEGREES F
- NOT REUSABLE - STICKING AND DE-STICKING OR DESOLDERING WILL CAUSE DAMAGE
- FOR PROTOTYPING ONLY. ALL DATA IS APPROXIMATE AND THESE PARTS ARE NOT DESIGNED FOR PRODUCTION USE.
- USE CARE WHEN SOLDERING. LONG EXPOSURE TO HEAT WILL CAUSE DELAMINATION
- DO NOT SOLDER ON TOP OF A TEXTILE

## RESISTANCE VS PRESSURE FOR EACH MATRIX SQUARE

GRAMS OF FORCE	RESISTANCE (IN OHMS)	RECOMMENDED OPERATING RANGE
150	180,000	
200	70,000	
250	27,000	
300	18,000	
350	15,000	
400	13,000	
450	13,500	
500	13,000	
6350	1,000	
10,886	600	
13,607	300	

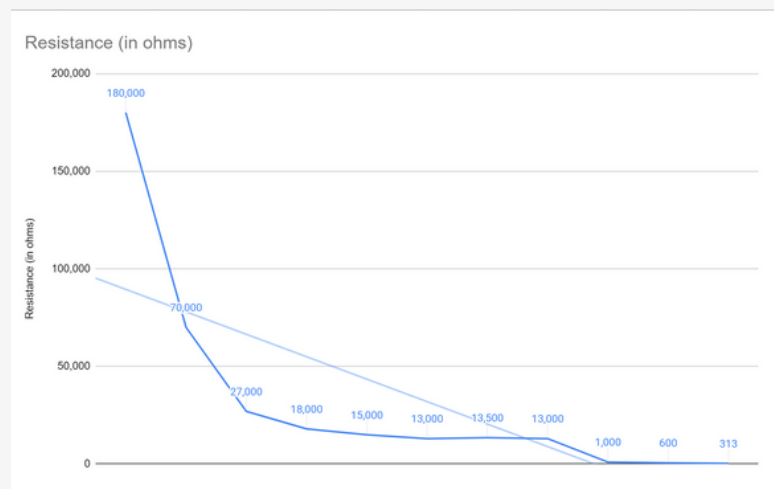

Our parts are produced by hand. There can be significant variation between units. Please use this data only as a reference, as your part's exact values may differ.





# 5V - 7.2V HEATER DATASHEET

The 5V - 7.2V heater is made to work with an off the shelf, 5V battery pack or two lipo batteries in series (just make sure both can output 2A safely). The heater will get hotter depending on the voltage you use. The heater warms up quickly with tangible heat within 60 seconds and top heat after 2 min. Use this component for heating wearables, or for thermochromic effects.

**MATERIALS:**  
 INSULATION: THERMOPLASTIC POLYURETHANE  
 INNER CONDUCTOR: PROPRIETARY  
 INTERCONNECT : RIGID-FLEX PCB

**DATA:**  
 BEND RADIUS LIMITATION: NONE  
 THICKNESS: APPROX 10 MILS  
 OPERATING VOLTAGE RANGE: 5V - 7.2V  
 CURRENT PULL: 1A - 2A  
 TEMPERATURE RANGE: 125F - 165F  
 COMPONENT DIMENSIONS: 6" X 6"

## PINOUT:

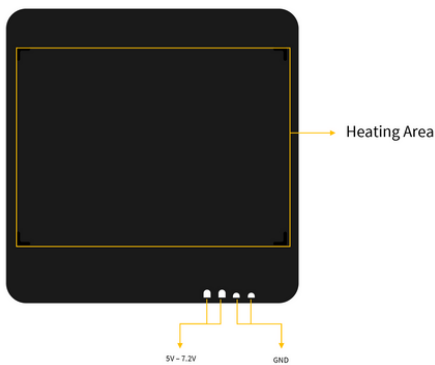

## OPERATING NOTES:

- DO NOT WASH
- DO NOT CUT
- DO NOT DISASSEMBLE
- DO NOT SEW
- DO NOT EXPOSE TO TEMPERATURES ABOVE 150 DEGREES F
- NOT REUSABLE - STICKING AND DE-STICKING OR DESOLDERING WILL CAUSE DAMAGE
- FOR PROTOTYPING ONLY. ALL DATA IS APPROXIMATE AND THESE PARTS ARE NOT DESIGNED FOR PRODUCTION USE.
- USE CARE WHEN SOLDERING. LONG EXPOSURE TO HEAT WILL CAUSE DELAMINATION
- DO NOT SOLDER ON TOP OF A TEXTILE

## HEATING PROFILE

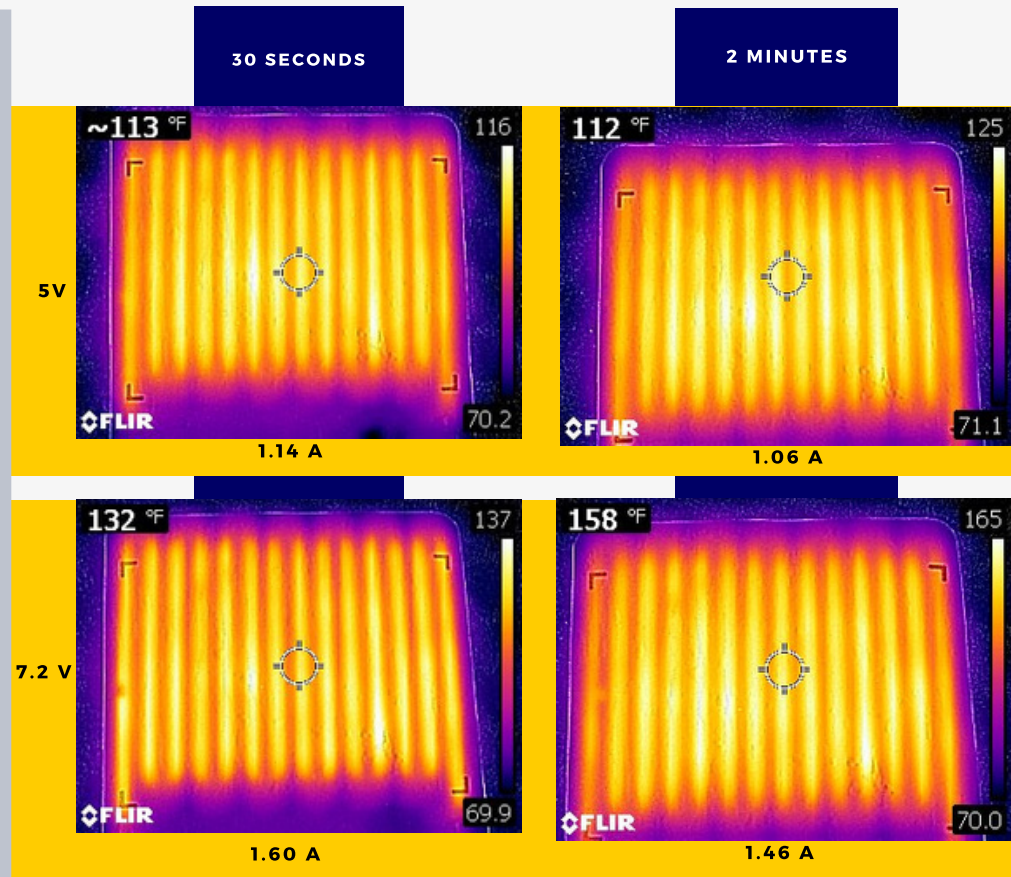

- Our parts are produced by hand. There can be significant variation between units. Please use this data only as a reference, as your part's exact values may differ.



# SINGLE BACKLIT BUTTON DATASHEET

The single backlit button is a simple mechanical switch that comes with an LED inside. When you press the button, the circuit is completed, driving your pin high or low. Use the embedded LED to make a glowing power icon, logo, or whatever suits your fancy.

## MATERIALS:

INSULATION: THERMOPLASTIC POLYURETHANE  
INNER CONDUCTOR: PROPRIETARY  
INTERCONNECT : ENIG FLEX PCB

## SINGLE BACKLIT BUTTON

BEND RADIUS LIMITATION: .5" AROUND BUTTON AREA  
THICKNESS: APPROX 1 MM AT BUTTON  
OPERATING VOLTAGE RANGE: 5V  
COMPONENT DIMENSIONS: 2" X 3"  
BUTTON DIMENSIONS: 1" DIAMETER CIRCLE  
DURABILITY: 10,000 PRESSES UNDER 5LBF

## PINOUT:

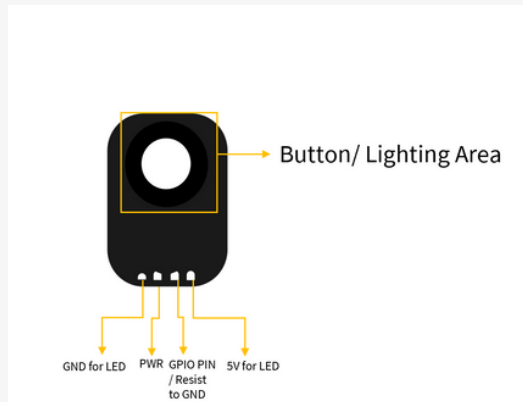

## USE SUGGESTION

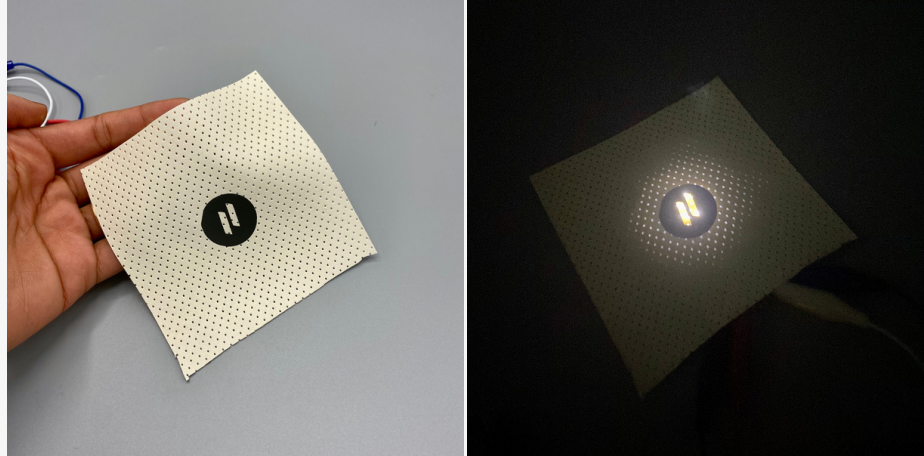

**TIP: Use a cut-out vinyl sticker or other kind of mask to make backlit logos from your button.**

## OPERATING NOTES:

- DO NOT WASH
- DO NOT CUT
- DO NOT DISASSEMBLE
- DO NOT SEW
- DO NOT EXPOSE TO TEMPERATURES ABOVE 150 DEGREES F
- NOT REUSABLE - STICKING AND DE-STICKING OR DESOLDERING WILL CAUSE DAMAGE
- FOR PROTOTYPING ONLY. ALL DATA IS APPROXIMATE AND THESE PARTS ARE NOT DESIGNED FOR PRODUCTION USE.
- USE CARE WHEN SOLDERING. LONG EXPOSURE TO HEAT WILL CAUSE DELAMINATION
- DO NOT SOLDER ON TOP OF A TEXTILE

- Our parts are produced by hand. There can be significant variation between units. Please use this data only as a reference, as your part's exact values may differ.