

FEATURES

- Tri-axis gyroscope with digital range scaling**
 $\pm 75^\circ/s$, $\pm 150^\circ/s$, $\pm 300^\circ/s$ settings
 14-bit resolution
- Tri-axis accelerometer**
 $\pm 10 g$ measurement range
 14-bit resolution
- 350 Hz bandwidth**
- Factory calibrated sensitivity, bias, and alignment**
 ADIS16350: $+25^\circ C$
 ADIS16355: $-40^\circ C$ to $+85^\circ C$
- Digitally controlled bias calibration**
- Digitally controlled sample rate**
- Digitally controlled filtering**
- Programmable condition monitoring**
- Auxiliary digital input/output**
- Digitally activated self-test**
- Programmable power management**
- Embedded temperature sensor**
- SPI-compatible serial interface**
- Auxiliary 12-bit ADC input and DAC output**
- Single-supply operation: 4.75 V to 5.25 V**
- 2000 g shock survivability**

APPLICATIONS

- Guidance and control
- Platform control and stabilization
- Motion control and analysis
- Inertial measurement units
- General navigation
- Image stabilization
- Robotics

GENERAL DESCRIPTION

The ADIS16350/ADIS16355 *iSensor™* is a complete triple axis gyroscope and triple axis accelerometer inertial sensing system. This sensor combines the Analog Devices, Inc., *iMEMS®* and mixed signal processing technology to produce a highly integrated solution that provides calibrated, digital inertial sensing. An SPI interface and simple output register structure allow for easy access to data and configuration controls.

The SPI port provides access to the following embedded sensors: X-, Y-, and Z-axis angular rates; X-, Y-, and Z-axis linear acceleration; internal temperature; power supply; and auxiliary analog input. The inertial sensors are precision-aligned across axes, and are calibrated for offset and sensitivity. An embedded

FUNCTIONAL BLOCK DIAGRAM

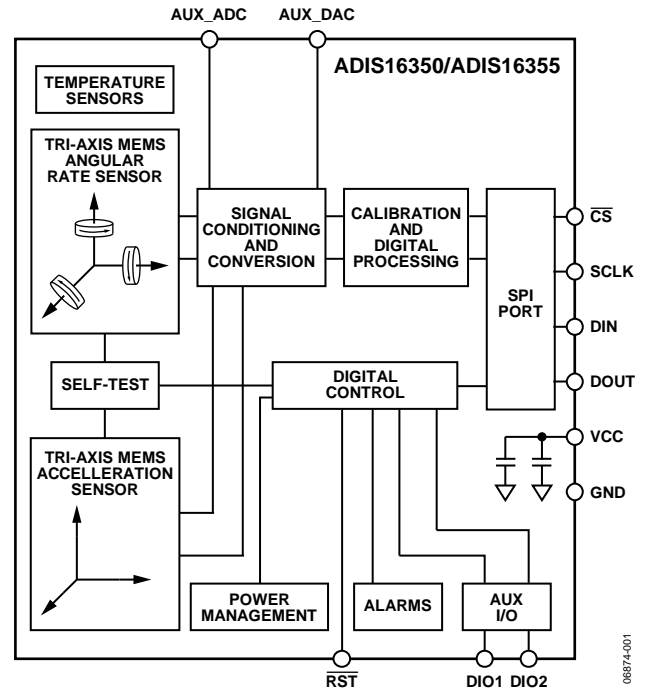

Figure 1.

controller dynamically compensates for all major influences on the MEMS sensors, thus maintaining highly accurate sensor outputs without further testing, circuitry, or user intervention.

The following programmable features simplify system integration: in-system autobias calibration, digital filtering and sample rate, self-test, power management, condition monitoring, and auxiliary digital input/output.

This compact module is approximately 23 mm × 23 mm × 23 mm and provides a convenient flex-based connector system.

Rev. B

Information furnished by Analog Devices is believed to be accurate and reliable. However, no responsibility is assumed by Analog Devices for its use, nor for any infringements of patents or other rights of third parties that may result from its use. Specifications subject to change without notice. No license is granted by implication or otherwise under any patent or patent rights of Analog Devices. Trademarks and registered trademarks are the property of their respective owners.

TABLE OF CONTENTS

Features	1	Control Register Structure	12
Applications.....	1	Auxiliary ADC Function.....	12
Functional Block Diagram	1	Basic Operation	13
General Description	1	Serial Peripheral Interface (SPI).....	13
Revision History	2	Data Output Register Access	14
Specifications.....	3	Programming and Control.....	15
Timing Specifications	6	Control Register Overview	15
Timing Diagrams.....	6	Control Register Structure	15
Absolute Maximum Ratings.....	7	Calibration.....	16
ESD Caution.....	7	Global Commands	16
Pin Configuration and Function Descriptions.....	8	Operational Control.....	17
Typical Performance Characteristics	9	Status and Diagnostics	19
Theory of Operation	12	Applications Information	22
Overview.....	12	Installation Guidelines.....	22
Gyroscope Sensor	12	Outline Dimensions	24
Accelerometer Sensor	12	Ordering Guide	24
Factory Calibration	12		

REVISION HISTORY

9/09—Rev. A to Rev. B

Changes to Figure 4 and Figure 5	7
Changes to Ordering Guide	24

2/08—Rev. 0 to Rev. A

Added ADIS16355.....Universal	
Changes to Features.....	1
Changes to General Description	1
Changes to Temperature Coefficient Throughout Table 1 and Gyroscope Noise Performance Output Noise.....	3
Changes to Output Range.....	4
Added Endnote 1	5
Changes to Table 3.....	7
Inserted Figure 4.....	8
Deleted Figure 10.....	8
Inserted Figure 9, Figure 10, and Figure 11	9
Deleted Figure 12.....	9
Changes to Figure 13 and Figure 14.....	10

Inserted Figure 15.....	10
Deleted Figure 17, Figure 18, Figure 20, and Figure 21.....	10
Changes to Factory Calibration Section.....	12
Changes to Writing to Registers Section.....	13
Replaced Data Output Register Access Section	14
Deleted Figure 28.....	15
Changes to Table 9.....	15
Changes to Global Commands Section.....	16
Changes to Internal Sample Rate Section	17
Changes to Auxiliary DAC Section.....	18
Changes to General-Purpose Input/Output Section	18
Changes to Table 37	21
Changes to Installation Guidelines Section	22
Updated Outline Dimensions.....	24
Changes to Ordering Guide	24

8/07—Revision 0: Initial Version

SPECIFICATIONS

$T_A = -40^{\circ}\text{C}$ to $+85^{\circ}\text{C}$, $V_{CC} = 5.0\text{ V}$, angular rate = $0^{\circ}/\text{s}$, dynamic range = $300^{\circ}/\text{s}$, $\pm 1\text{ g}$, unless otherwise noted.

Table 1.

Parameter	Conditions	Min	Typ	Max	Unit
GYROSCOPE SENSITIVITY	Each axis				
Initial Sensitivity	25°C, dynamic range = $\pm 300^{\circ}/\text{s}$	0.0725	0.07326	0.0740	$^{\circ}/\text{s}/\text{LSB}$
	25°C, dynamic range = $\pm 150^{\circ}/\text{s}$		0.03663		$^{\circ}/\text{s}/\text{LSB}$
	25°C, dynamic range = $\pm 75^{\circ}/\text{s}$		0.01832		$^{\circ}/\text{s}/\text{LSB}$
Temperature Coefficient	ADIS16350, see Figure 6		600		$\text{ppm}/^{\circ}\text{C}$
	ADIS16355, see Figure 9		40		$\text{ppm}/^{\circ}\text{C}$
Gyroscope Axis Nonorthogonality	25°C, difference from 90° ideal		± 0.05		Degree
Gyroscope Axis Misalignment	25°C, relative to base-plate and guide pins		± 0.5		Degree
Nonlinearity	Best fit straight line		0.1		% of FS
GYROSCOPE BIAS					
In Run Bias Stability	25°C, 1σ		0.015		$^{\circ}/\text{s}$
Angular Random Walk	25°C		4.2		$^{\circ}/\sqrt{\text{hr}}$
Temperature Coefficient	ADIS16350, see Figure 7		0.1		$^{\circ}/\text{s}/^{\circ}\text{C}$
	ADIS16355, see Figure 10		0.01		$^{\circ}/\text{s}/^{\circ}\text{C}$
Linear Acceleration Effect	Any axis, 1σ (linear acceleration bias compensation enabled)		0.05		$^{\circ}/\text{s}/\text{g}$
Voltage Sensitivity	$V_{CC} = 4.75\text{ V}$ to 5.25 V		0.25		$^{\circ}/\text{s}/\text{V}$
GYROSCOPE NOISE PERFORMANCE					
Output Noise	25°C, $\pm 300^{\circ}/\text{s}$ range, 2-tap filter setting		0.60		$^{\circ}/\text{s}$ rms
	25°C, $\pm 150^{\circ}/\text{s}$ range, 8-tap filter setting		0.35		$^{\circ}/\text{s}$ rms
	25°C, $\pm 75^{\circ}/\text{s}$ range, 32-tap filter setting		0.17		$^{\circ}/\text{s}$ rms
Rate Noise Density	25°C, $f = 25\text{ Hz}$, $\pm 300^{\circ}/\text{s}$, no filtering		0.05		$^{\circ}/\text{s}/\sqrt{\text{Hz}}$ rms
GYROSCOPE FREQUENCY RESPONSE					
3 dB Bandwidth			350		Hz
Sensor Resonant Frequency			14		kHz
GYROSCOPE SELF-TEST STATE					
Change for Positive Stimulus	$\pm 300^{\circ}/\text{s}$ range setting	432	723	1105	LSB
Change for Negative Stimulus	$\pm 300^{\circ}/\text{s}$ range setting	-432	-723	-1105	LSB
Internal Self-Test Cycle Time			25		ms
ACCELEROMETER SENSITIVITY	Each axis				
Dynamic Range		± 8	± 10		g
Initial Sensitivity	25°C	2.471	2.522	2.572	mg/LSB
Temperature Coefficient	ADIS16350, see Figure 8		100		$\text{ppm}/^{\circ}\text{C}$
	ADIS16355, see Figure 11		40		$\text{ppm}/^{\circ}\text{C}$
Axis Nonorthogonality	25°C, difference from 90° ideal		± 0.25		Degree
Axis Misalignment	25°C, relative to base-plate and guide pins		± 0.5		Degree
Nonlinearity	Best fit straight line		± 0.2		% of FS
ACCELEROMETER BIAS					
In-Run Bias Stability	25°C, 1σ		0.7		mg
Velocity Random Walk	25°C		2.0		$\text{m}/\text{s}/\sqrt{\text{hr}}$
Temperature Coefficient	ADIS16350, see Figure 12		4		$\text{mg}/^{\circ}\text{C}$
	ADIS16355, see Figure 15		0.5		$\text{mg}/^{\circ}\text{C}$

ADIS16350/ADIS16355

Parameter	Conditions	Min	Typ	Max	Unit
ACCELEROMETER NOISE PERFORMANCE					
Output Noise	25°C, no filtering		35		mg rms
Noise Density	25°C, no filtering		1.85		mg/ $\sqrt{\text{Hz}}$ rms
ACCELEROMETER FREQUENCY RESPONSE					
3 dB Bandwidth			350		Hz
Sensor Resonant Frequency			10		kHz
ACCELEROMETER SELF-TEST STATE					
Output Change When Active		73	146	219	LSB
TEMPERATURE SENSOR					
Output at 25°C			0		LSB
Scale Factor			6.88		LSB/°C
ADC INPUT					
Resolution			12		Bits
Integral Nonlinearity			± 2		LSB
Differential Nonlinearity			± 1		LSB
Offset Error			± 4		LSB
Gain Error			± 2		LSB
Input Range		0		2.5	V
Input Capacitance	During acquisition		20		pF
DAC OUTPUT					
	5 k Ω /100 pF to GND				
Resolution			12		Bits
Relative Accuracy	For Code 101 to Code 4095		± 4		LSB
Differential Nonlinearity			± 1		LSB
Offset Error			± 5		mV
Gain Error			± 0.5		%
Output Range				2.5	V
Output Impedance			2		Ω
Output Settling Time			10		μs
LOGIC INPUTS¹					
Input High Voltage, V_{INH}		2.0			V
Input Low Voltage, V_{INL}				0.8	V
	For $\overline{\text{CS}}$ signal when used to wake up from sleep mode			0.55	V
Logic 1 Input Current, I_{INH}	$V_{\text{IH}} = 3.3 \text{ V}$		± 0.2	± 10	μA
Logic 0 Input Current, I_{INL}	$V_{\text{IL}} = 0 \text{ V}$				
All Except $\overline{\text{RST}}$			-40	-60	μA
$\overline{\text{RST}}$			-1		mA
Input Capacitance, C_{IN}			10		pF
DIGITAL OUTPUTS¹					
Output High Voltage, V_{OH}	$I_{\text{SOURCE}} = 1.6 \text{ mA}$	2.4			V
Output Low Voltage, V_{OL}	$I_{\text{SINK}} = 1.6 \text{ mA}$			0.4	V
SLEEP TIMER					
Timeout Period ²		0.5		128	Sec
FLASH MEMORY					
Endurance ³		10,000			Cycles
Data Retention ⁴	$T_{\text{J}} = 85^\circ\text{C}$	20			Years
CONVERSION RATE					
Maximum Sample Rate	SMPL_PRD = 0x01		819.2		SPS
Minimum Sample Rate	SMPL_PRD = 0xFF		0.413		SPS

ADIS16350/ADIS16355

Parameter	Conditions	Min	Typ	Max	Unit
START-UP TIME ⁵					
Initial Power-Up			150		ms
Sleep Mode Recovery			3		ms
POWER SUPPLY					
Operating Voltage Range, V_{CC}		4.75	5.0	5.25	V
Power Supply Current	Normal mode at 25°C		33		mA
	Fast mode at 25°C		57		mA
	Sleep mode at 25°C		500		μA

¹ The digital I/O signals are driven by an internal 3.3 V supply, and the inputs are 5 V tolerant.

² Guaranteed by design.

³ Endurance is qualified as per JEDEC Standard 22, Method A117 and measured at -40°C, +25°C, +85°C, and +125°C.

³ Retention lifetime equivalent at junction temperature (T_J) 85°C as per JEDEC Standard 22, Method A117. Retention lifetime decreases with junction temperature.

⁵ Defined as the time from wake-up to the first conversion. This time does not include sensor settling time, which is dependent on the filter settings.

ADIS16350/ADIS16355

TIMING SPECIFICATIONS

$T_A = 25^\circ\text{C}$, $V_{CC} = 5.0\text{ V}$, angular rate = $0^\circ/\text{s}$, unless otherwise noted.

Table 2.

Parameter	Description	Min ¹	Typ	Max ¹	Unit
f_{SCLK}	Fast mode, $\text{SMPL_PRD} \leq 0x09$ ($f_s \geq 164\text{ Hz}$) Normal mode, $\text{SMPL_PRD} \geq 0x0A$ ($f_s \leq 149\text{ Hz}$)	0.01 10		2 300	MHz kHz
t_{Datarate}	Data rate time, fast mode, $\text{SMPL_PRD} \leq 0x09$ ($f_s \geq 164\text{ Hz}$)	40			μs
	Data rate time, normal mode, $\text{SMPL_PRD} \geq 0x0A$ ($f_s \leq 149\text{ Hz}$)	160			μs
$t_{\text{DataStall}}$	Data stall time, fast mode $\text{SMPL_PRD} \leq 0x09$ ($f_s \geq 164\text{ Hz}$)	9			μs
	Data stall time, normal mode $\text{SMPL_PRD} \geq 0x0A$ ($f_s \leq 149\text{ Hz}$)	75			μs
$t_{\overline{\text{CS}}}$	Chip select to clock edge	48.8			ns
t_{DAV}	Data output valid after SCLK falling edge ²			100	ns
t_{DSU}	Data input setup time before SCLK rising edge	24.4			ns
t_{DHD}	Data input hold time after SCLK rising edge	48.8			ns
t_{DF}	Data output fall time		5	12.5	ns
t_{DR}	Data output rise time		5	12.5	ns
t_{SFS}	$\overline{\text{CS}}$ high after SCLK edge ³	5			ns

¹ Guaranteed by design, not production tested.

² The MSB presents an exception to this parameter. The MSB clocks out on the falling edge of $\overline{\text{CS}}$. The rest of the DOUT bits are clocked after the falling edge of SCLK and are governed by this specification.

³ This parameter may need to be expanded to allow for proper capture of the LSB. After $\overline{\text{CS}}$ goes high, the DOUT line goes into a high impedance state.

TIMING DIAGRAMS

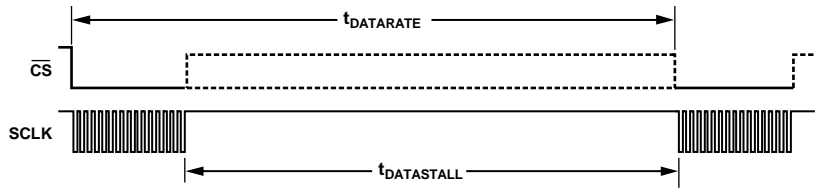

Figure 2. SPI Chip Select Timing

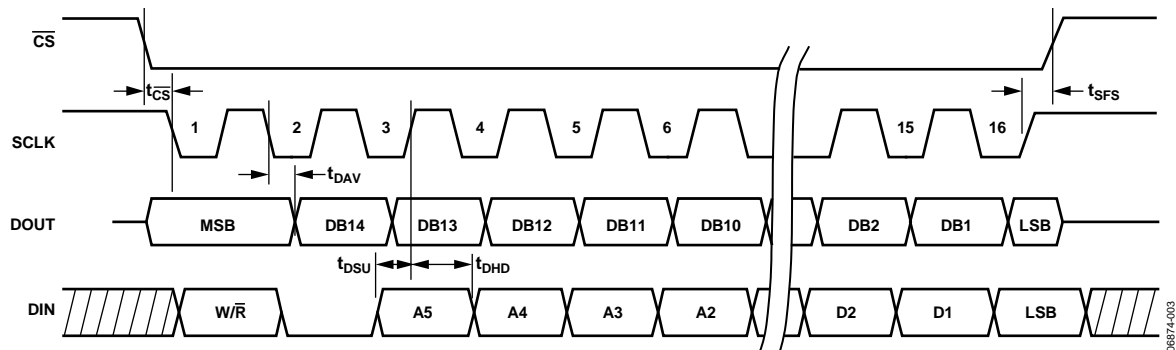

Figure 3. SPI Timing, Utilizing SPI Settings Typically Identified as Phase = 1, Polarity = 1

ABSOLUTE MAXIMUM RATINGS

Table 3.

Parameter	Rating
Acceleration	
Any Axis, Unpowered	2000 <i>g</i>
Any Axis, Powered	2000 <i>g</i>
VCC to GND	−0.3 V to +6.0 V
Digital Input/Output Voltage to GND	−0.3 V to +5.3 V
Analog Inputs to GND	−0.3 V to +3.6 V
Operating Temperature Range	−40°C to +85°C
Storage Temperature Range	−65°C to +125°C ^{1, 2}

¹ Extended exposure to temperatures outside the specified temperature range of −40°C to +85°C can adversely affect the accuracy of the factory calibration. For best accuracy, store the parts within the specified operating range of −40°C to +85°C.

² Although the device is capable of withstanding short-term exposure to 150°C, long-term exposure threatens internal mechanical integrity.

Stresses above those listed under Absolute Maximum Ratings may cause permanent damage to the device. This is a stress rating only; functional operation of the device at these or any other conditions above those indicated in the operational section of this specification is not implied. Exposure to absolute maximum rating conditions for extended periods may affect device reliability.

Table 4. Package Characteristics

Package Type	θ_{JA}	θ_{JC}	Device Weight
24-Lead Module	39.8°C/W	14.2°C/W	16 grams

ESD CAUTION



ESD (electrostatic discharge) sensitive device. Charged devices and circuit boards can discharge without detection. Although this product features patented or proprietary protection circuitry, damage may occur on devices subjected to high energy ESD. Therefore, proper ESD precautions should be taken to avoid performance degradation or loss of functionality.

ADIS16350/ADIS16355

PIN CONFIGURATION AND FUNCTION DESCRIPTIONS

ADIS16350/ADIS16355

TOP VIEW
(Not to Scale)

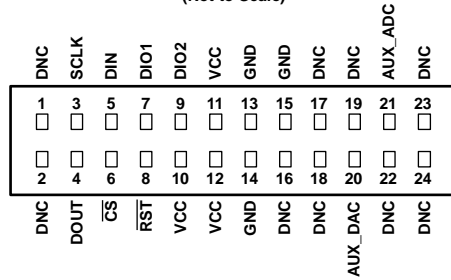

NOTES

1. THIS REPRESENTATION DISPLAYS THE TOP VIEW PINOUT FOR THE MATING SOCKET CONNECTOR.
2. THE ACTUAL CONNECTOR PINS ARE NOT VISIBLE FROM THE TOP VIEW.
3. MATING CONNECTOR: SAMTEC CLM-112-02 OR EQUIVALENT.
4. DNC = DO NOT CONNECT.

Figure 4. Pin Configuration

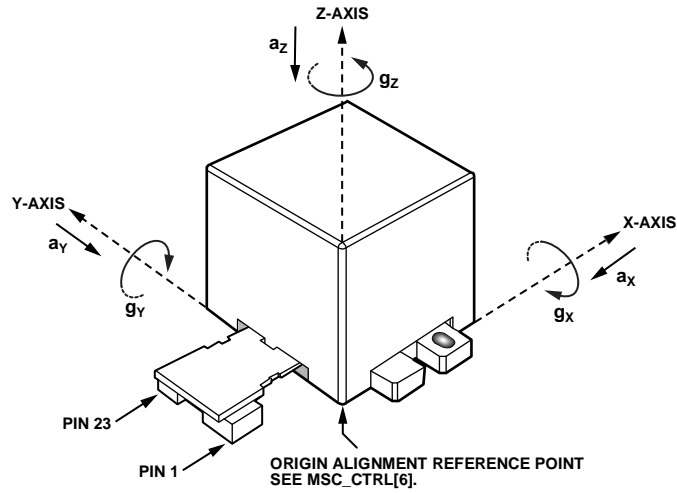

NOTES

1. ACCELERATION (a_x , a_y , a_z) AND ROTATIONAL (g_x , g_y , g_z) ARROWS INDICATE THE DIRECTION OF MOTION THAT PRODUCES A POSITIVE OUTPUT.

Figure 5. Pin Configuration, Connector Top View

Table 5. Pin Function Descriptions

Pin No.	Mnemonic	Type ¹	Description
1, 2, 16, 17, 18, 19, 22, 23, 24	DNC	N/A	Do Not Connect
3	SCLK	I	SPI Serial Clock
4	DOUT	O	SPI Data Output
5	DIN	I	SPI Data Input
6	\overline{CS}	I	SPI Chip Select
7	DIO1	I/O	Digital Input/Output
8	\overline{RST}	I	Reset
9	DIO2	I/O	Digital Input/Output
10, 11, 12	VCC	S	Power Supply
13, 14, 15	GND	S	Power Ground
20	AUX_DAC	O	Auxiliary, 12-Bit, DAC Output
21	AUX_ADC	I	Auxiliary, 12-Bit, ADC Input

¹S = supply, O = output, I = input.

TYPICAL PERFORMANCE CHARACTERISTICS

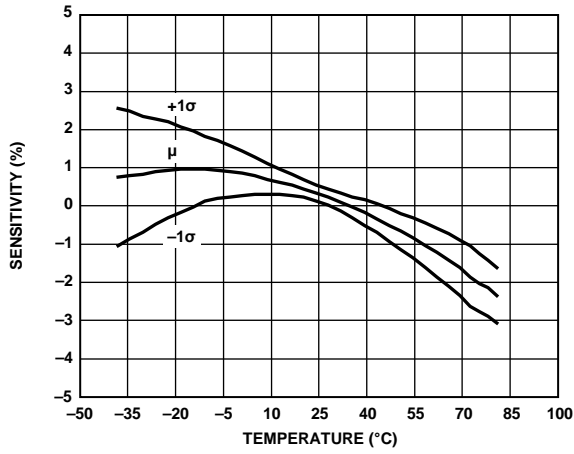

Figure 6. ADIS16350 Gyroscope Sensitivity vs. Temperature

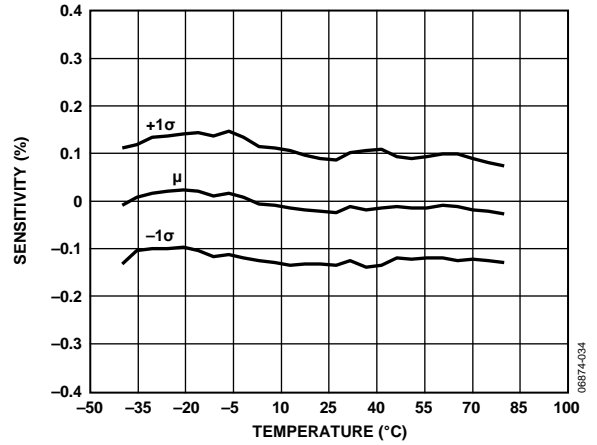

Figure 9. ADIS16355 Gyroscope Sensitivity vs. Temperature

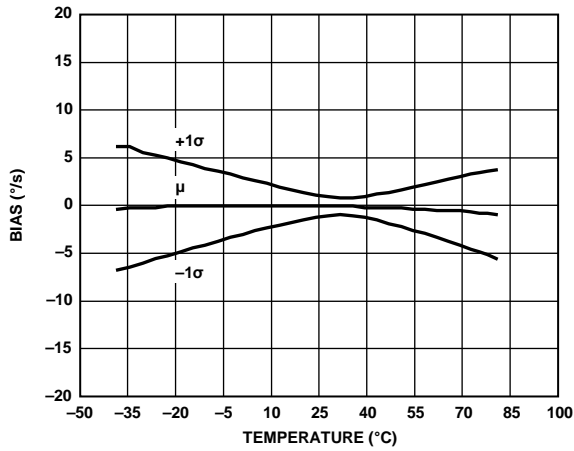

Figure 7. ADIS16350 Gyroscope Bias vs. Temperature

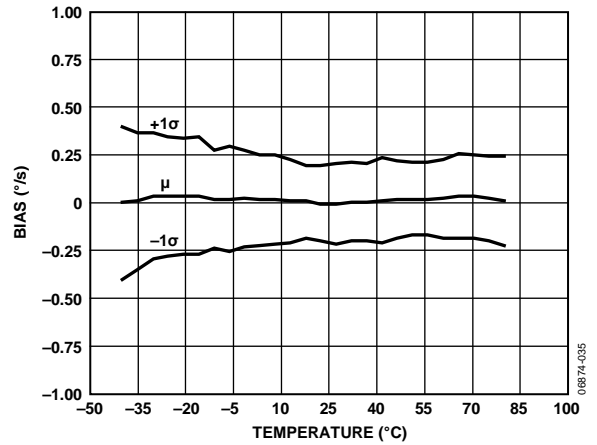

Figure 10. ADIS16355 Gyroscope Bias vs. Temperature

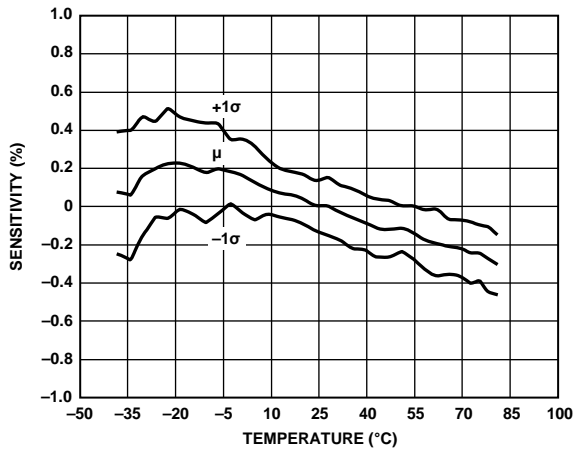

Figure 8. ADIS16350 Accelerometer Sensitivity vs. Temperature

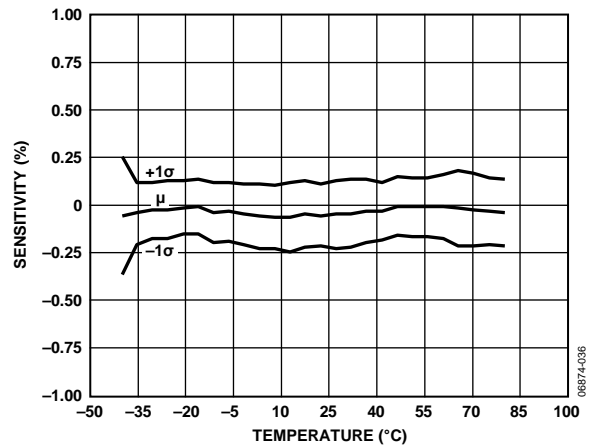

Figure 11. ADIS16355 Accelerometer Sensitivity vs. Temperature

ADIS16350/ADIS16355

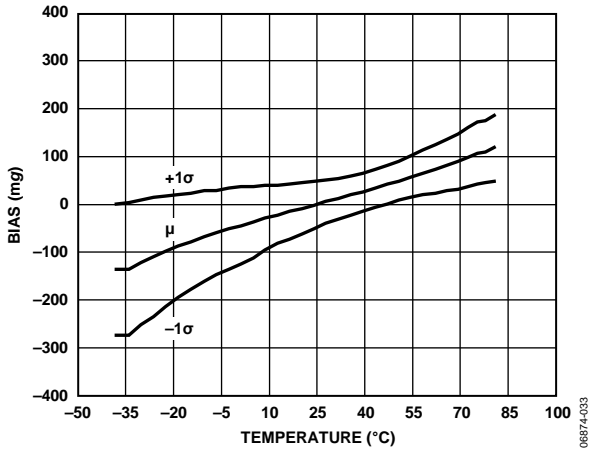

Figure 12. ADIS16350 Accelerometer Bias vs. Temperature

06874-033

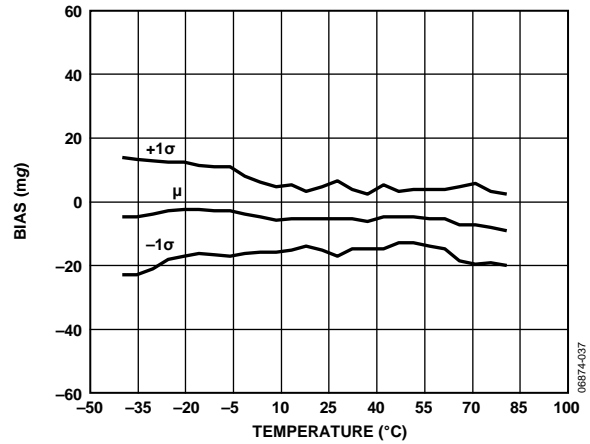

Figure 15. ADIS16355 Accelerometer Bias vs. Temperature

06874-037

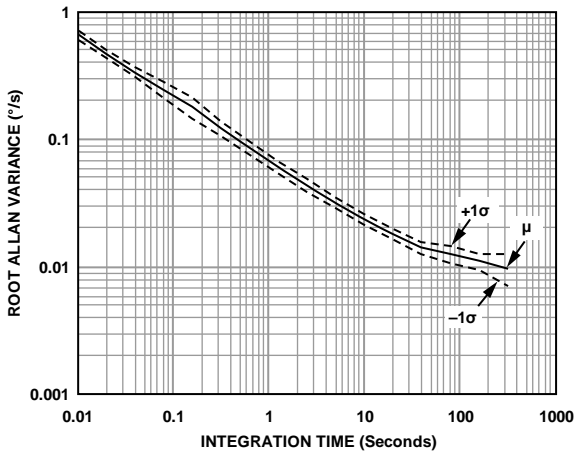

Figure 13. Gyroscope Root Allan Variance

06874-005

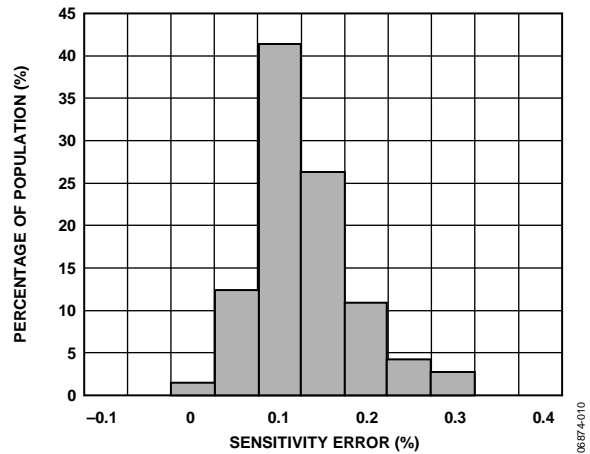

Figure 16. Gyroscope Sensitivity Error, +25°C

06874-010

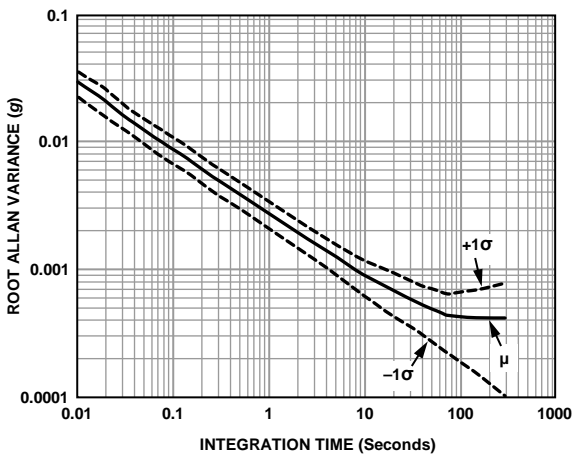

Figure 14. Accelerometer Root Allan Variance

06874-008

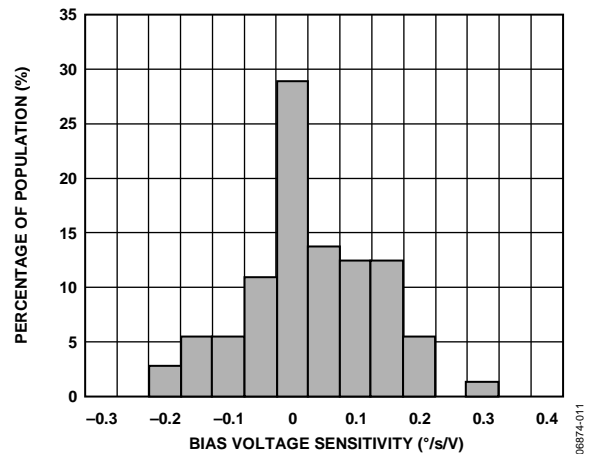

Figure 17. Gyroscope Bias Voltage Power Supply Sensitivity, +25°C

06874-011

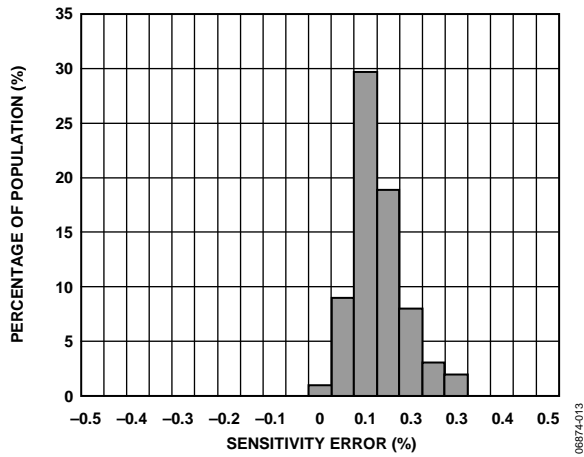

Figure 18. Accelerometer Sensitivity Error Distribution, +25°C

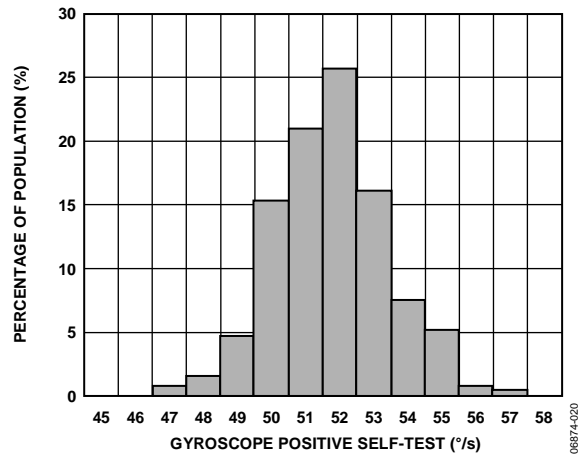

Figure 21. Gyroscope Positive Self-Test Distribution, +25°C

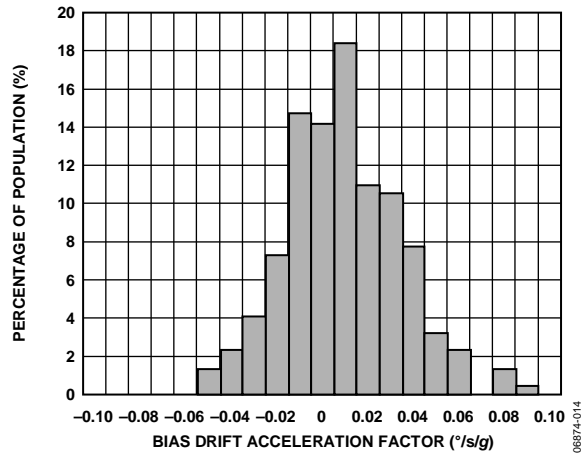

Figure 19. Gyroscope Bias Sensitivity to Linear Acceleration, +25°C

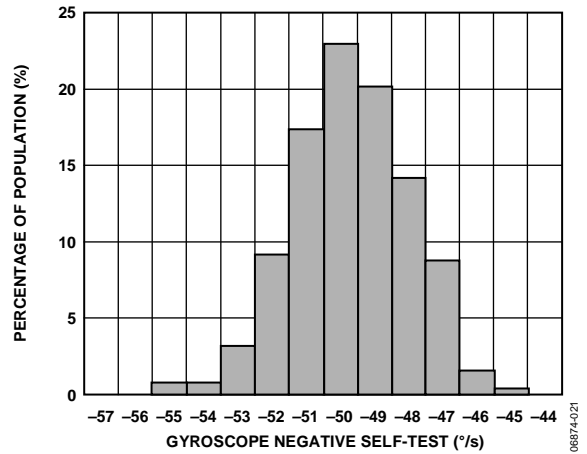

Figure 22. Gyroscope Negative Self-Test Distribution, +25°C

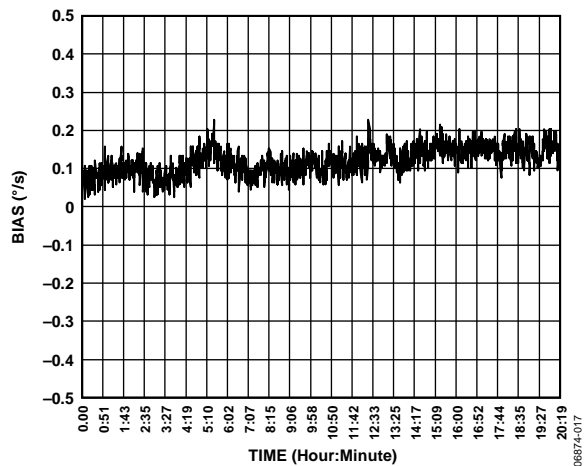

Figure 20. Long-Term Bias Stability, +25°C

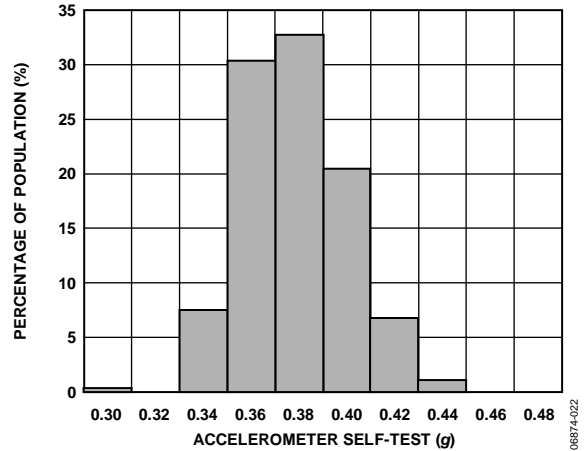

Figure 23. Accelerometer Self-Test Distribution, +25°C

THEORY OF OPERATION

OVERVIEW

The ADIS16350/ADIS16355 integrate three orthogonal axes of gyroscope sensors with three orthogonal axes of accelerometer sensors, creating the basic six degrees of freedom (6DOF) in a single package. The accelerometers are oriented along the axis of rotation for each gyroscope. These six sensing elements are held together by a mechanical structure that provides tight force and motion coupling. Each sensor output signal is sampled using an ADC, and then the digital data is fed into a proprietary digital processing circuit. The digital processing circuit applies the correction tables to each sensor output, manages the input/output function using a simple register structure and serial interface, and provides many other features that simplify system-level designs.

GYROSCOPE SENSOR

The core MEMs angular rate sensor (gyroscope) operates on the principle of a resonator gyroscope. Two polysilicon sensing structures each contain a dither frame, which is electrostatically driven to resonance. This provides the velocity element required to produce a Coriolis force during rotation. At two of the outer extremes of each frame, orthogonal to the dither motion, are movable fingers that are placed between fixed fingers to form a capacitive pickoff structure that senses Coriolis motion. The resulting signal is fed to a series of gain and demodulation stages that produce the electrical rate signal output.

ACCELEROMETER SENSOR

The core acceleration sensor is a surface micromachined polysilicon structure built on top of the silicon wafer. Polysilicon springs suspend the structure over the surface of the wafer and provide a resistance against acceleration forces. Deflection of the structure is measured using a differential capacitor that consists of independent fixed plates and central plates attached to the moving mass. Acceleration deflects the beam and unbalances the differential capacitor, resulting in a differential output that is fed to a series of gain and demodulation stages that produce the electrical rate signal output.

FACTORY CALIBRATION

The ADIS16350 provides a factory calibration that simplifies the process of integrating it into system-level designs. This calibration provides correction for initial sensor bias and sensitivity, power supply variation, axial alignment, and linear acceleration (gyroscopes). An extensive, three-dimensional characterization provides the basis for generating correction tables for each individual sensor. The ADIS16355 provides the same calibration, over temperature.

CONTROL REGISTER STRUCTURE

The ADIS16350/ADIS16355 provide configuration control to many critical operating parameters by using a dual-memory register structure. The volatile SRAM register locations control operation of the part while the nonvolatile flash memory locations preserve the configuration settings. Updating register contents affects only its SRAM location. Preserving the updates in its corresponding flash memory location requires initiation of the flash update command. This helps reduce the number of write cycles to the flash memory and consequently increases the endurance of the flash memory. During startup and reset-recovery sequences, the flash memory contents are automatically loaded into the SRAM register locations.

AUXILIARY ADC FUNCTION

The auxiliary ADC is a standard 12-bit ADC that digitizes other system-level analog signals. The output of the ADC can be monitored through the AUX_ADC register, as defined in Table 6. The ADC is a 12-bit successive approximation converter. The output data is presented in straight binary format with the full-scale range extending from 0 V to 2.5 V.

Figure 24 shows the equivalent circuit of the analog input structure of the ADC. The input capacitor (C1) is typically 4 pF and can be attributed to parasitic package capacitance. The two diodes provide ESD protection for the analog input. Care must be taken to ensure that the analog input signals are never outside the range of -0.3 V to $+3.5$ V. Signals outside this range causes the diodes to become forward-biased and to start conducting. The diodes can handle 10 mA without causing irreversible damage. The resistor is a lumped component that represents the on resistance of the switches. The value of this resistance is typically 100 Ω . Capacitor C2 represents the ADC sampling capacitor and is typically 16 pF.

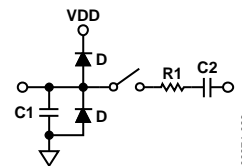

Figure 24. Equivalent Analog Input Circuit
Conversion Phase: Switch Open
Track Phase: Switch Closed

For ac applications, it is recommended that high frequency components from the analog input signal be removed by using a low-pass filter on the analog input pin.

In applications where harmonic distortion and signal-to-noise ratios are critical, the analog input must be driven from a low impedance source. Large source impedances significantly affect the ac performance of the ADC. This can necessitate the use of an input buffer amplifier. When no input amplifier is used to drive the analog input, the source impedance should be limited to values lower than 1 k Ω .

BASIC OPERATION

The ADIS16350/ADIS16355 are designed for simple integration into system designs, requiring only a 5 V power supply and a 4-wire, industry-standard serial peripheral interface (SPI). All outputs and user-programmable functions are handled by a simple register structure. Each register is 16 bits in length and has its own unique bit map. The 16 bits in each register consist of an upper byte (D8 to D15) and a lower byte (D0 to D7), each with its own 6-bit address.

SERIAL PERIPHERAL INTERFACE (SPI)

The serial peripheral interface (SPI) port includes four signals: chip select (\overline{CS}), serial clock (SCLK), data input (DIN), and data output (DOUT). The \overline{CS} line enables the SPI port and frames each SPI event. When this signal is high, the DOUT line is in a high impedance state and the signals on DIN and SCLK have no impact on operation. A complete data frame contains 16 clock cycles. Because the SPI port operates in full-duplex mode, it supports simultaneous, 16-bit receive (DIN) and transmit (DOUT) functions during the same data frame. This enables the user to configure the next read cycle, while, at the same time, receiving the data associated with the previous configuration.

Refer to Table 2, Figure 2, and Figure 3 for detailed information regarding timing and operation of the SPI port.

Writing to Registers

Figure 25 displays a typical data frame for writing a command to a control register. In this case, the first bit of the DIN sequence is a 1, followed by a 0, the 6-bit address of the target register, and the 8-bit data command. Because each write command covers a single byte of data, two data frames are required when writing the entire 16-bit space of a register. Note that 16 SCLK cycles are required for a successful write operation.

Reading from Registers

Reading the contents of a register requires a modification to the sequence illustrated in Figure 25. In this case, the first two bits in the DIN sequence are 0, followed by the address of the register. Each register has two addresses (an upper address and a lower address), but either one can be used to access the entire 16 bits of data. The final eight bits of the DIN sequence are irrelevant and can be counted as don't cares during a read command. During the next data frame, the DOUT sequence contains the 16-bit data of the register, as shown in Figure 26. Although a single read command requires two separate data frames, the full-duplex mode minimizes this overhead, requiring only one extra data frame when continuously sampling.

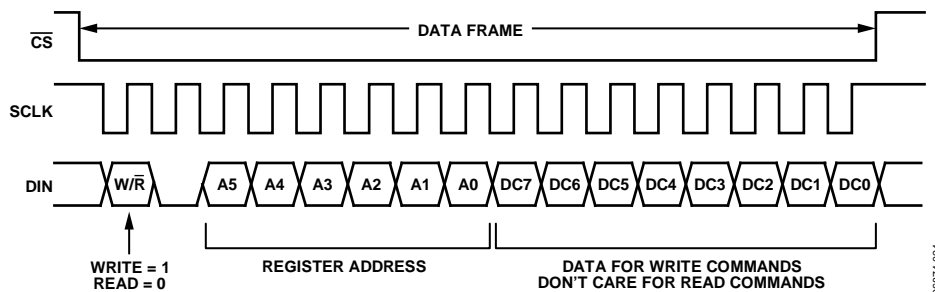

Figure 25. DIN Bit Sequence

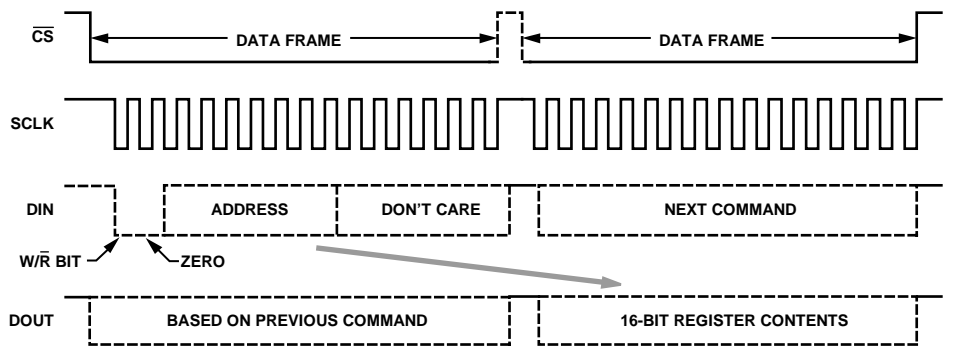

Figure 26. SPI Sequence for Read Commands

ADIS16350/ADIS16355

DATA OUTPUT REGISTER ACCESS

Table 6 provides the data configuration for each output data register in the ADIS16350/ADIS16355. Starting with the MSB of the upper byte, each output data register has the following bit sequence: new data (ND) flag, error/alarm (EA) flag, followed by 14 data bits. The data bits are LSB-justified and, in the case of the 12-bit data formats, the remaining two bits (Bit 12 and Bit

13) are not used. The ND flag indicates that unread data resides in the output data registers. This flag clears and returns to 0 during an output register read sequence. It returns to 1 after the next internal sample update cycle completes. The EA flag indicates an error condition. The STATUS register contains all of the error flags and provides the ability to investigate root cause.

Table 6. Output Data Register Information

Name	Function	Addresses	Data Length	Data Format	Scale Factor (per LSB)
SUPPLY_OUT	Power supply measurement	0x03, 0x02	12 bits	Binary	1.8315 mV ¹
XGYRO_OUT	X-axis gyroscope output measurement	0x05, 0x04	14 bits	Twos complement	0.07326°/s ²
YGYRO_OUT	Y-axis gyroscope output measurement	0x07, 0x06	14 bits	Twos complement	0.07326°/s ²
ZGYRO_OUT	Z-axis gyroscope output measurement	0x09, 0x08	14 bits	Twos complement	0.07326°/s ²
XACCL_OUT	X-axis acceleration output measurement	0x0B, 0x0A	14 bits	Twos complement	2.522 mg
YACCL_OUT	Y-axis acceleration output measurement	0x0D, 0x0C	14 bits	Twos complement	2.522 mg
ZACCL_OUT	Z-axis acceleration output measurement	0x0F, 0x0E	14 bits	Twos complement	2.522 mg
XTEMP_OUT	X-axis gyroscope sensor temperature measurement	0x11, 0x10	12 bits	Twos complement	0.1453°C ³
YTEMP_OUT	Y-axis gyroscope sensor temperature measurement	0x13, 0x12	12 bits	Twos complement	0.1453°C ³
ZTEMP_OUT	Z-axis gyroscope sensor temperature measurement	0x15, 0x14	12 bits	Twos complement	0.1453°C ³
AUX_ADC	Auxiliary analog input data	0x17, 0x16	12 bits	Binary	0.6105 mV

¹ 5 V = 2730 LSBs (nominal)

² Assumes that the scaling is set to 300°/s.

³ Typical condition, 25°C = 0 LSB.

Table 7. Output Coding Example, XGYRO_OUT, YGYRO_OUT, and ZGYRO_OUT^{1,2}

Rate of Rotation			Binary Output	Hexadecimal Output	Decimal
±300°/s Range	±150°/s Range	±75°/s Range			
80°/s	40°/s	20°/s	00 0100 0100 0100	0x0444	1092
40°/s	20°/s	10°/s	00 0010 0010 0010	0x0222	546
0.07326°/s	0.03663°/s	0.018315°/s	00 0000 0000 0001	0x0001	1
0°/s	0°/s	0°/s	00 0000 0000 0000	0x0000	0
-0.07326°/s	-0.03663°/s	-0.018315°/s	11 1111 1111 1111	0x3FFF	-1
-40°/s	-20°/s	-10°/s	11 1101 1101 1110	0x3DDE	-546
-80°/s	-40°/s	-20°/s	11 1011 1011 1100	0x3BBC	-1092

¹ The two most significant bits are not included.

² Zero offset null performance is assumed.

Table 8. Output Coding Example, XACCL_OUT, YACCL_OUT, and ZACCL_OUT^{1,2}

Acceleration (g)	Binary Output	Hexadecimal Output	Decimal
2.522	00 0011 1110 1000	0x03E8	1000
1	00 0001 1000 1101	0x018D	397
0.002522	00 0000 0000 0001	0x0001	1
0	00 0000 0000 0000	0x0000	0
-0.002522	11 1111 1111 1111	0x3FFF	-1
-1	11 1110 0111 0011	0x3E73	-397
-2.522	11 1100 0001 1000	0x3C18	-1000

¹ The two most significant bits are not included.

² Zero offset null performance is assumed.

PROGRAMMING AND CONTROL

CONTROL REGISTER OVERVIEW

There are many programmable features that are controlled by writing commands to the appropriate control registers using the SPI. The following sections describe these controls and specify each function, along with the corresponding register configuration. The features available for configuration in this register space are:

- Calibration
- Global commands
- Operational control
 - Sample rate
 - Power management
 - Digital filtering
 - Dynamic range
 - DAC output
 - Digital input/output
- Operational status and diagnostics
 - Self-test
 - Status conditions
 - Alarms

CONTROL REGISTER STRUCTURE

The ADIS16350/ADIS16355 use a temporary, RAM-based memory structure to facilitate the control registers listed in Table 9. The operational configuration is stored in a flash memory structure that automatically loads into the control registers during the start-up sequence. Each nonvolatile register has a corresponding flash memory location for storing the latest configuration contents. The contents of each nonvolatile register must be stored to flash manually.

Note that the contents of these registers are nonvolatile after they are stored to flash. The flash update command, available in the COMMAND register, provides this function. The ENDURANCE register provides a counter that allows for reliability management against the flash memory write cycle specification.

Table 9. Control Register Mapping

Register Name	Type	Volatility	Addresses	Bytes	Function	Reference Tables
ENDURANCE	R	Nonvolatile	0x00, 0x01	2	Flash memory write count	Table 29
	R	Volatile	0x02 to 0x17	22	Output data	Table 6
			0x18, 0x19	2	Reserved	
XGYRO_OFF	R/W	Nonvolatile	0x1A, 0x1B	2	X-axis gyroscope bias offset factor	Table 10, Table 11
YGYRO_OFF	R/W	Nonvolatile	0x1C, 0x1D	2	Y-axis gyroscope bias offset factor	Table 10, Table 11
ZGYRO_OFF	R/W	Nonvolatile	0x1E, 0x1F	2	Z-axis gyroscope bias offset factor	Table 10, Table 11
XACCL_OFF	R/W	Nonvolatile	0x20, 0x21	2	X-axis acceleration bias offset factor	Table 12, Table 13
YACCL_OFF	R/W	Nonvolatile	0x22, 0x23	2	Y-axis acceleration bias offset factor	Table 12, Table 13
ZACCL_OFF	R/W	Nonvolatile	0x24, 0x25	2	Z-axis acceleration bias offset factor	Table 12, Table 13
ALM_MAG1	R/W	Nonvolatile	0x26, 0x27	2	Alarm 1 amplitude threshold	Table 32, Table 33
ALM_MAG2	R/W	Nonvolatile	0x28, 0x29	2	Alarm 2 amplitude threshold	Table 32, Table 33
ALM_SMPL1	R/W	Nonvolatile	0x2A, 0x2B	2	Alarm 1 sample size	Table 34, Table 35
ALM_SMPL2	R/W	Nonvolatile	0x2C, 0x2D	2	Alarm 2 sample size	Table 34, Table 35
ALM_CTRL	R/W	Nonvolatile	0x2E, 0x2F	2	Alarm control	Table 36, Table 37
AUX_DAC	R/W	Volatile	0x30, 0x31	2	Auxiliary DAC data	Table 22, Table 23
GPIO_CTRL	R/W	Volatile	0x32, 0x33	2	Auxiliary digital input/output control	Table 24, Table 25
MSC_CTRL	R/W	Nonvolatile ¹	0x34, 0x35	2	Miscellaneous control	Table 27, Table 28
SMPL_PRD	R/W	Nonvolatile	0x36, 0x37	2	Internal sample period (rate) control	Table 16, Table 17
SENS/AVG	R/W	Nonvolatile	0x38, 0x39	2	Dynamic range/digital filter control	Table 20, Table 21
SLP_CNT	R/W	Volatile	0x3A, 0x3B	2	Sleep mode control	Table 18, Table 19
STATUS	R	Volatile	0x3C, 0x3D	2	System status	Table 30, Table 31
COMMAND	W	N/A	0x3E, 0x3F	2	System command	Table 14, Table 15

¹ The contents of the lower byte are nonvolatile; the contents of the upper byte are volatile.

ADIS16350/ADIS16355

CALIBRATION

For applications that require point-of-use calibration, the bias correction registers provide bias level control for all six sensors. Table 10, Table 11, Table 12, and Table 13 provide the details required for using these registers to calibrate the output bias for each sensor.

Table 10. Gyroscope Bias Correction Registers

Register	Addresses	Common Parameters
XGYRO_OFF	0x1A, 0x1B	Default value = 0x0000
YGYRO_OFF	0x1C, 0x1D	Scale = 0.018315°/s per LSB
ZGYRO_OFF	0x1E, 0x1F	Twos complement, read/write

Table 11. Gyroscope Bias Correction Register Bits

Bits	Description
[15:13]	Not used
[12:0]	Data bits, typical adjustment range = $\pm 75^\circ$

Table 12. Accelerometer Bias Correction Registers

Register	Addresses	Common Parameters
XACCL_OFF	0x21, 0x20	Default value = 0x0000
YACCL_OFF	0x23, 0x22	Scale = 2.522 mg per LSB
ZACCL_OFF	0x25, 0x24	Twos complement, read/write

Table 13. Accelerometer Bias Correction Register Bits

Bits	Description
[15:12]	Not used
[11:0]	Data bits, typical adjustment range = $\pm 5.16 g$

Manual Bias Calibration

Because each offset bias register has read/write access, the bias of each sensor is adjustable. For example, if an output offset of 0.18°/s is observed in the Z-axis gyroscope, the ZGYRO_OFF register provides the calibration factor necessary to improve the accuracy. Using its sensitivity of 0.018315°/s, an adjustment of -10 LSBs is required. The twos complement, hexadecimal code of -10 LSBs is 0x1FF6.

To implement this calibration factor, use the following pseudocode:

```
Write 0xF6 to Address 0x1E, then write 0x1F to
Address 0x1F
```

This step reduces the 0.18°/s error term to 0.00315°/s.

Automatic Bias Null Calibration

A single-command, automatic bias calibration measures all three gyroscope output registers, then loads the three bias correction registers with values that return their outputs to zero (null). A single register write command starts this process (see Table 15).

```
Write 0x01 to Address 0x3E
```

Precision Automatic Bias Null Calibration

Another option for gyroscope calibration, which typically provides better accuracy, is with the single-command, precision autonull. This incorporates the optimal averaging time for generating bias correction factors for all three gyroscope sensors. This command requires approximately 30 seconds to complete. For optimal calibration accuracy, the device should be stable (no motion) for this entire period. Once it has started, a reset command is needed to stop it prematurely, if required. The following sequence starts this calibration option (see Table 15):

```
Write 0x10 to Address 0x3E
```

Restoring Factory Calibration

The factory calibration can be restored by returning the contents of each bias correction register to their default value of zero. This command also flushes all of the data from the digital filter taps. To accomplish this function for all six sensor signal paths (see Table 15),

```
Write 0x02 to Address 0x3E
```

Linear Acceleration Bias Compensation (Gyroscopes)

The following command enables compensation for acceleration influences on gyroscope bias behavior:

```
Set Bit 7 of Address 0x34 to 1 (see Table 28)
```

Linear Acceleration Origin Alignment

The following command provides origin alignment for the accelerometers to the point of percussion (see Figure 5), using the MSC_CTRL register.

```
Set Bit 6 of Address 0x34 to 1 (see Table 28)
```

GLOBAL COMMANDS

Global commands provide single-write initiations for common operations such as calibration, flash update, auxiliary DAC latch, and software reset. Each global command has a unique control bit assigned to it in the COMMAND register and is initiated by writing 1 to its assigned bit.

The flash update command writes the contents of each non-volatile register into flash memory for storage. This process takes approximately 100 ms and requires the power supply voltage to be within specification for the duration of the event. Note that this operation also automatically follows the autonull, precision autonull, and factory reset commands. After waiting the appropriate time for the flash update to complete, verify successful completion by reading the STATUS register (flash update error = 0, if successful).

The DAC latch command loads the contents of AUX_DAC into the DAC latches, which control the actual output level. This overcomes the challenge of discontinuous outputs that would otherwise be associated with two separate write cycles for upper and lower bytes. Finally, the software reset command sends the ADIS16350/ADIS16355 digital processor into a restart sequence, effectively accomplishing the same tasks as the RST line.

Table 14. COMMAND Register Definition

Address	Default	Format	Access
0x3F, 0x3E	N/A	N/A	Write only

Table 15. COMMAND Bit Descriptions

Bits	Description
[15:8]	Not used
[7]	Software reset command
[6:5]	Not used
[4]	Precision autonull command
[3]	Flash update command
[2]	Auxiliary DAC data latch
[1]	Factory calibration restore command
[0]	Autonull command

OPERATIONAL CONTROL

Internal Sample Rate

The internal sample rate defines how often data output variables are updated, independent of the rate at which they are read out on the SPI port. The SMPL_PRD register controls the internal sample rate and has two parts: a time base and a multiplier. The sample period can be calculated using the following equation:

$$T_s = T_B \times (N_S + 1)$$

where:

T_s is the sample period.

T_B is the time base.

N_S is the multiplier.

The default value is the minimum register setting, 0x01, which corresponds to the maximum sample rate of 819.2 samples per second. The contents of this register are nonvolatile.

Table 16. SMPL_PRD Register Definition

Address	Default	Format	Access
0x37, 0x36	0x0001	N/A	R/W

Table 17. SMPL_PRD Bit Descriptions

Bits	Description
[15:8]	Not used
[7]	Time base, 0 = 0.61035 ms, 1 = 18.921 ms
[6:0]	Multiplier (add 1 before multiplying by the time base)

An example calculation of the sample period for the device is

$$\text{If } SMPL_PRD = 0x0007, \text{ Bits } [7:0] = 00000111$$

$$\text{Bit } 7 = 0, \text{ so } T_B = 0.61035 \text{ ms}$$

$$\text{Bits } [6:0] = 0000111 = 7 = N_S$$

$$T_s = T_B \times (N_S + 1) = 0.61035 \text{ ms} \times (7 + 1) = 4.8828 \text{ ms}$$

$$f_s = 1/T_s = 204.8 \text{ SPS}$$

The sample rate setting has a direct impact on the SPI data rate capability. For SMPL_PRD settings $\leq 0x09$ (fast mode), the SPI SCLK can run at a rate up to 2.0 MHz. For SMPL_PRD settings $> 0x09$ (normal mode), the SPI SCLK can run at a rate up to 300 kHz.

The sample rate setting also affects the power dissipation. The normal mode power ($SMPL_PRD > 0x09$) dissipation is approximately 67% less than the fast mode ($SMPL_PRD \leq 0x09$) power dissipation. The two different modes of operation offer a system-level trade-off between performance (sample rate, serial transfer rate) and power dissipation.

Power Management

In addition to offering two different performance modes for power optimization, the SLP_CNT register provides a programmable shutdown period. Writing the appropriate sleep time to the lower byte of the SLP_CNT register shuts the device down for the specified time. The following example illustrates this relationship:

$$\text{Bits } [7:0] = 00000110 = 6 \text{ codes} = 3 \text{ seconds}$$

At the completion of the programmed duration, normal operation resumes. If measurements are required before sleep period completion or if it is necessary to end the indefinite shutdown, the device can be awakened by pulling the \overline{CS} line down to a 0 state, then returning it to a 1 state. Otherwise, the \overline{CS} line must be kept in a 1 (high) state to maintain sleep mode.

When writing a sleep time to the SLP_CNT register, the time between the 16th SCLK edge and the CS rising edge must be less than 10 μ s in fast mode and less than 80 μ s in normal mode.

Table 18. SLP_CNT Register Definition

Address	Scale ¹	Default	Format	Access
0x3B, 0x3A	0.5 sec	0x0000	Binary	R/W

¹ Scale is the weight of each LSB in the lower byte of this register.

Table 19. SLP_CNT Bit Descriptions

Bits	Description
[15:8]	Not used
[7:0]	Data bits

Digital Filtering

The signal conditioning circuit of each sensor has an analog bandwidth of approximately 350 Hz. A programmable-length Bartlett Window FIR filter provides opportunity for additional noise reduction on all of the output data registers. The SENS/AVG register controls the number of taps in power-of-two step sizes, from zero to six.

Filter setup requires one simple step: write the appropriate M factor to the assigned bits in the SENS/AVG register. The bit assignments are listed in Table 21. The frequency response relationship for this filter is:

$$H_B(f) = H_A^2(f) \quad H_A(f) = \frac{\sin(\pi \times N \times f \times t_s)}{N \times \sin(\pi \times f \times t_s)}$$

ADIS16350/ADIS16355

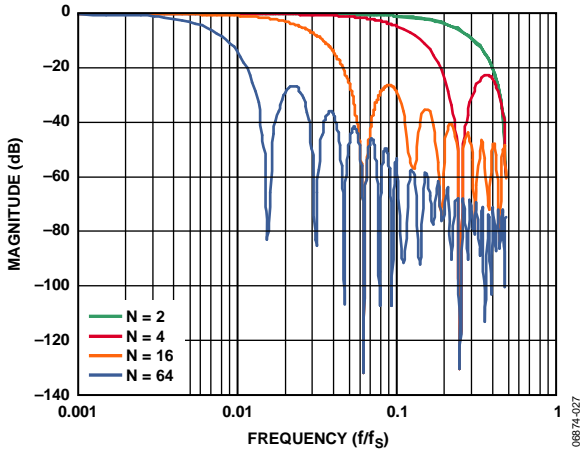

Figure 27. Bartlett Window FIR Frequency Response

Dynamic Range

There are three dynamic range settings: $\pm 75^\circ/\text{s}$, $\pm 150^\circ/\text{s}$, and $\pm 300^\circ/\text{s}$. The lower dynamic range settings (75, 150) limit the minimum filter tap sizes to maintain the resolution as the measurement range decreases. The recommended order for programming the SENS/AVG register is upper byte (sensitivity), followed by lower byte (filtering). The contents of the SENS/AVG register are nonvolatile.

Table 20. SENS/AVG Register Definition

Address	Default	Format	Access
0x39, 0x38	0x0402	N/A	R/W

Table 21. SENS/AVG Bit Descriptions

Bits	Value	Description
[15:11]		Not used
[10:8]		Measurement range (sensitivity) selection
	100	300°/s (default condition)
	010	150°/s, filter taps ≥ 4 (Bits [2:0] $\geq 0x02$)
	001	75°/s, filter taps ≥ 16 (Bits [2:0] $\geq 0x04$)
[7:3]		Not used
[2:0]		Filter tap setting, number of taps, $N = 2^M$; for example, 011, $N = 2^3 = 8$ taps

Auxiliary DAC

The auxiliary DAC provides a 12-bit level adjustment function. The AUX_DAC register controls the operation of this feature. It offers a rail-to-rail buffered output that has a range of 0 V to 2.5 V. The DAC can drive its output to within 5 mV of the ground reference when it is not sinking current. As the output approaches ground, the linearity begins to degrade (100 LSB beginning point). As the sink current increases, the nonlinear range increases. The DAC output latch function, contained in the COMMAND register, provides continuous operation while writing each byte of this register. The contents of this register are volatile, which means that the desired output level must be set after every reset and power cycle event.

Table 22. AUX_DAC Register Definition

Address	Default	Format	Access
0x31, 0x30	0x0000	Binary	R/W

Table 23. AUX_DAC Bit Descriptions

Bits	Description
[15:12]	Not used
[11:0]	Data bits; 0x0000 – 0 V output, 0x0FFF – 2.5 V output

Updating the DAC output voltage requires four steps.

1. Determine the binary number associated with the desired output level.
2. Write the lower eight bits of this binary number to the lower address of the AUX_DAC register.
3. Write the upper eight bits of this binary number to the upper address of the AUX_DAC register.
4. Execute the DAC latch global command by writing 0x04 to Address 0x3E (see Table 15).

General-Purpose Input/Output

Two general-purpose pins enable digital input/output control using the SPI. The GPIO_CTRL control register establishes the configuration of these pins and handles the SPI-to-pin controls. Each pin provides the flexibility of both input (read) and output (write) operations.

For example, writing 0x0202 to this register establishes Line 2 as an output and sets its level as a 1. Writing 0x0000 to this register establishes both lines as inputs, and their status can be read through Bit 8 and Bit 9 of this register.

The digital input/output lines are also available for data-ready and alarm/error indications. In the event of conflict, the following priority structure governs the digital input/output configuration:

1. MSC_CTRL (Data-ready indicator)
2. ALM_CTRL (Alarm indicator)
3. GPIO_CTRL (General-purpose)

Table 24. GPIO_CTRL Register Definition

Address	Default	Format	Access
0x33, 0x32	0x0000	N/A	R/W

Table 25. GPIO_CTRL Bit Descriptions

Bits	Description
[15:10]	Not used
[9]	General-purpose input/output Line 2 data level 1 = high, 0 = low
[8]	General-purpose input/output Line 1 data level 1 = high, 0 = low
[7:2]	Not used
[1]	General-purpose input/output Line 2, data direction control 1 = output, 0 = input
[0]	General-purpose input/output Line 1, data direction control 1 = output, 0 = input

The contents of the GPIO_CTRL register are volatile.

STATUS AND DIAGNOSTICS

Table 26 summarizes a number of status and diagnostic operations, along with their corresponding control registers.

Table 26. Status and Diagnostic Functions

Register	Function
MSC_CTRL	Data-ready input/output indicator; self-test, mechanical check for sensor element
STATUS	Status: Check for predefined error conditions
ENDURANCE	Flash memory endurance
ALM_MAG1	Alarms: Configure and check for user-specific conditions
ALM_MAG2	
ALM_SMPL1	
ALM_SMPL2	
ALM_CTRL	

Data-Ready Input/Output Indicator

The data-ready function provides an indication of updated output data. The MSC_CTRL register allows the user to configure either of the general-purpose input/output pins (DIO1 or DIO2) as a data-ready indicator signal.

Table 27. MSC_CTRL Register Definition

Address	Default	Format	Access
0x35, 0x34	0x0000	N/A	R/W

Table 28. MSC_CTRL Bit Descriptions

Bits	Description
[15:11]	Not used
[10]	Internal self-test enable (clears on completion) 1 = enabled, 0 = disabled
[9]	Manual self-test, negative stimulus 1 = enabled, 0 = disabled
[8]	Manual self-test, positive stimulus 1 = enabled, 0 = disabled
[7]	Linear acceleration bias compensation for gyroscopes 1 = enabled, 0 = disabled
[6]	Linear accelerometer origin alignment 1 = enabled, 0 = disabled
[5:3]	Not used
[2]	Data-ready enable 1 = enabled, 0 = disabled
[1]	Data-ready polarity 1 = active high, 0 = active low
[0]	Data-ready line select 1 = DIO2, 0 = DIO1

Self-Test

The MSC_CTRL register also provides a self-test function that verifies the mechanical integrity of the MEMS sensor. There are two different self-test options: internal self-test and external self-test.

The internal test provides a simple, two-step process for checking the MEMS sensor.

1. Start the process by writing 1 to Bit 10 in the MSC_CTRL register.
2. Wait long enough for the response to settle, then check the result by reading Bit 5 of the STATUS register.

If a failure is indicated, then Bits [10:15] of the STATUS register indicate which of the six sensors it is associated with.

The entire cycle takes approximately 35 ms, and the output data is not available during this time. The external self-test is a static condition that can be enabled and disabled. In this test, both positive and negative gyroscope MEMS sensor movements are available. For the accelerometers, only positive MEMS sensor movement is available.

After writing to the appropriate control bit, the output registers reflect the changes after a delay that reflects the response time associated with the sensor/signal conditioning circuit. For example, the standard 350 Hz bandwidth reflects an exponential response with a time constant of 0.45 ms. Note that the digital filtering affects this delay as well. The appropriate bit definitions for self-test are listed in Table 27 and Table 28.

Flash Memory Endurance

The ENDURANCE register maintains a running count of writes to the flash memory. It provides up to 32,768 counts. Note that if this count is exceeded, the register wraps around and goes back to zero, before beginning to increment again.

Table 29. ENDURANCE Register Definition

Address	Default	Format	Access
0x01, 0x00	N/A	Binary	Read only

ADIS16350/ADIS16355

Status Conditions

The STATUS register contains the following error condition flags: alarm conditions, self-test status, overrange, SPI communication failure, control register update failure, and power supply range failure. See Table 30 and Table 31 for the appropriate register access and bit assignment for each flag.

The bits assigned for checking power supply range and sensor overrange automatically reset to 0 when the error condition no longer exists. The remaining error flag bits in the STATUS register require a read to return them to 0. Note that a STATUS register read clears all of the bits to 0. If any error conditions remain, the bits revert to 1 during the next internal output register update cycle.

Table 30. STATUS Register Definition

Address	Default	Format	Access
0x3D, 0x3C	0x0000	N/A	Read only

Table 31. STATUS Bit Descriptions

Bits	Description
[15]	Z-axis accelerometer self-diagnostic error flag 1 = failure, 0 = passing
[14]	Y-axis accelerometer self-diagnostic error flag 1 = failure, 0 = passing
[13]	X-axis accelerometer self-diagnostic error flag 1 = failure, 0 = passing
[12]	Z-axis gyroscope self-diagnostic error flag 1 = failure, 0 = passing
[11]	Y-axis gyroscope self-diagnostic error flag 1 = failure, 0 = passing
[10]	X-axis gyroscope self-diagnostic error flag 1 = failure, 0 = passing
[9]	Alarm 2 status 1 = active, 0 = inactive
[8]	Alarm 1 status 1 = active, 0 = inactive
[7:6]	Not used
[5]	Self-test diagnostic error flag 1 = error condition, 0 = normal operation
[4]	Sensor over range (any of the six) 1 = error condition, 0 = normal operation
[3]	SPI communications failure 1 = error condition, 0 = normal operation
[2]	Control register update failed 1 = error condition, 0 = normal operation
[1]	Power supply in range above 5.25 V 1 = above 5.25 V, 0 = below 5.25 V (normal)
[0]	Power supply below 4.75 V 1 = below 4.75 V, 0 = above 4.75 V (normal)

Alarms

Two independent alarms provide programmable condition monitoring. Event detections occur when output register data meets the configured conditions. Configuration options include the following:

- All output data registers are available for monitoring as the source data.
- The source data can be filtered or unfiltered.
- Comparisons can be static or dynamic (rate of change).
- The threshold levels and times are configurable.
- Comparison can be greater than or less than.

The ALM_MAG1 register and the ALM_MAG2 register both establish the threshold level for detecting events. These registers take on the format of the source data and provide a bit for establishing the greater than/less than comparison direction.

When making dynamic comparisons, the ALM_SMPL1 register and the ALM_SMPL2 register establish the number of averages taken for the source data as a reference for comparison. In this configuration, each subsequent source data sample is subtracted from the previous one, establishing an instantaneous delta. The ALM_CTRL register controls the source data selection, static/dynamic selection, filtering selection, and digital input/output usage for the alarms.

The rate of change calculation is

$$Y_C = \frac{1}{N_{DS}} \sum_{n=1}^{N_{DS}} y(n+1) - y(n)$$

The rate of change alarm is determined by comparing

Y_C with M_C according to the ALM_MAG1/ALM_MAG2 settings

where:

N_{DS} is the number of samples in ALM_SMPL1 and ALM_SMPL2.

$y(n)$ is the sampled output data.

M_C is the magnitude for comparison in ALM_MAG1 and ALM_MAG2.

Y_C is the factor to compare with M_C .

Table 32. ALM_MAG1 and ALM_MAG2 Register Definitions

Register	Addresses	Default	Format	Access
ALM_MAG1	0x27, 0x26	0x0000	N/A	R/W
ALM_MAG2	0x29, 0x28	0x0000	N/A	R/W

Table 33. ALM_MAG1 and ALM_MAG2 Bit Descriptions

Bits	Description
[15]	Comparison polarity: 1 = greater than, 0 = less than
[14]	Not used
[13:0]	Data bits, format matches source data format

Table 34. ALM_SMPL1 and ALM_SIMPL2 Register Definitions

Registers	Addresses	Default	Format	Access
ALM_SMPL1	0x2B, 0x2A	0x0000	Binary	R/W
ALM_SIMPL2	0x2D, 0x2C	0x0000	Binary	R/W

Table 35. ALM_SMPL1 and ALM_SIMPL2 Bit Descriptions

Bit	Description
[15:8]	Not used
[7:0]	Data bits

Table 36. ALM_CTRL Register Definition

Addresses	Default	Format	Access
0x2F, 0x2E	0x0000	N/A	R/W

Table 37. ALM_CTRL Bit Designations

Bits	Value	Description
[15:12]		Alarm 2 source selection
	0000	Disable
	0001	Power supply output
	0010	X-axis gyroscope output
	0011	Y-axis gyroscope output
	0100	Z-axis gyroscope output
	0101	X-axis accelerometer output
	0110	Y-axis accelerometer output
	0111	Z-axis accelerometer output
	1000	X-axis gyroscope temperature output
	1001	Y-axis gyroscope temperature output
	1010	Z-axis gyroscope temperature output
	1011	Auxiliary ADC input
[11:8]		Alarm 1 source selection (same as Alarm 2)
[7]		Rate of change (ROC) enable for Alarm 2 1 = rate of change, 0 = static level
[6]		Rate of change (ROC) enable for Alarm 1 1 = rate of change, 0 = static level
[5]		Not used
[4]		Comparison data filter setting 1 = filtered data, 0 = unfiltered data
[3]		Not used
[2]		Alarm output enable 1 = enabled, 0 = disabled
[1]		Alarm output polarity 1 = active high, 0 = active low
[0]		Alarm output line select 1 = DIO2, 0 = DIO1

APPLICATIONS INFORMATION

INSTALLATION GUIDELINES

Installation requires two steps: mechanical attachment of the body, followed by the electrical connection. This device is designed for postsolder reflow installation. It is not designed to survive the temperatures associated with normal solder reflow processes.

Mechanical Attachment

The open mounting tabs on each side of the body provide enough room for 2 mm (or 2-56) machine screws. Note that 316 stainless steel and aluminum screws are available for use in this attachment.

When planning the installation process, the primary trade-off to consider is the attachment strength advantage of stainless steel against the nonmagnetic properties of aluminum for systems that are sensitive to magnetic field disturbances.

Figure 28 provides a graphical display of the mechanical attachment, and Figure 29 provides a recommendation for the physical layout of all the holes required for attaching these devices.

Electrical Connections

The electrical interface is a single connector that is attached to a flexible circuit extension.

One option for mating connectors can be found in the Samtec CLM family. In this case, the part number starts with CLM-112-02. The flexible circuit has stress relief points to absorb environmental stresses, such as temperature cycling and vibration. Figure 29 provides the alignment hole locations for designs that employ the suggested connector mate. The dimensions offered in Figure 29 assume that the device and the mating connector are on the same surface. The electrical connection is held by friction only.

Proper Removal

The flexible circuit interface can tear under excessive force conditions. An example of excessive force is attempting to break the electrical connection by pulling on the body of the device, placing all of the stress on the flexible circuit.

The electrical connector must be broken by an appropriate tool, which is designed to apply even pressure to each side of the rigid part of the flex cable. The recommended extraction sequence is to break the mate between the electrical interface, and then to remove the mechanical attachment hardware.

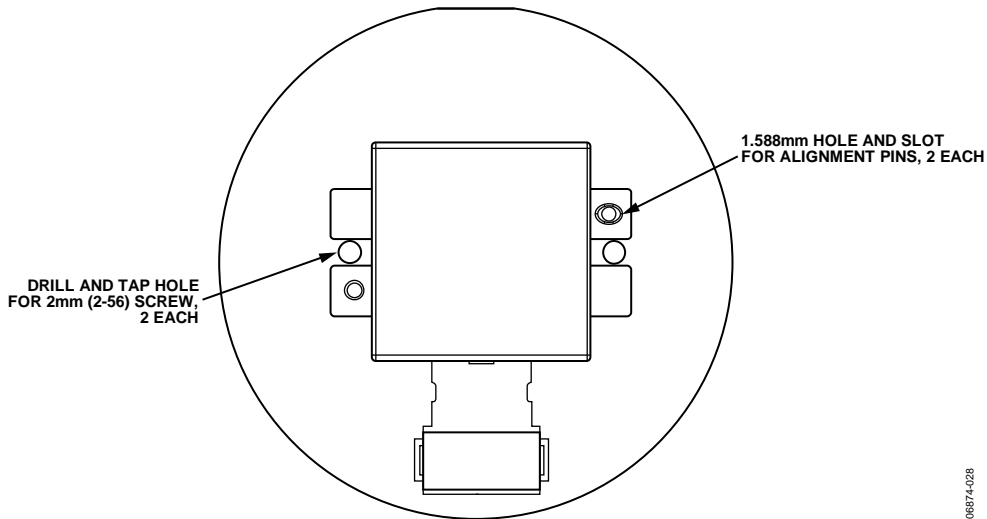
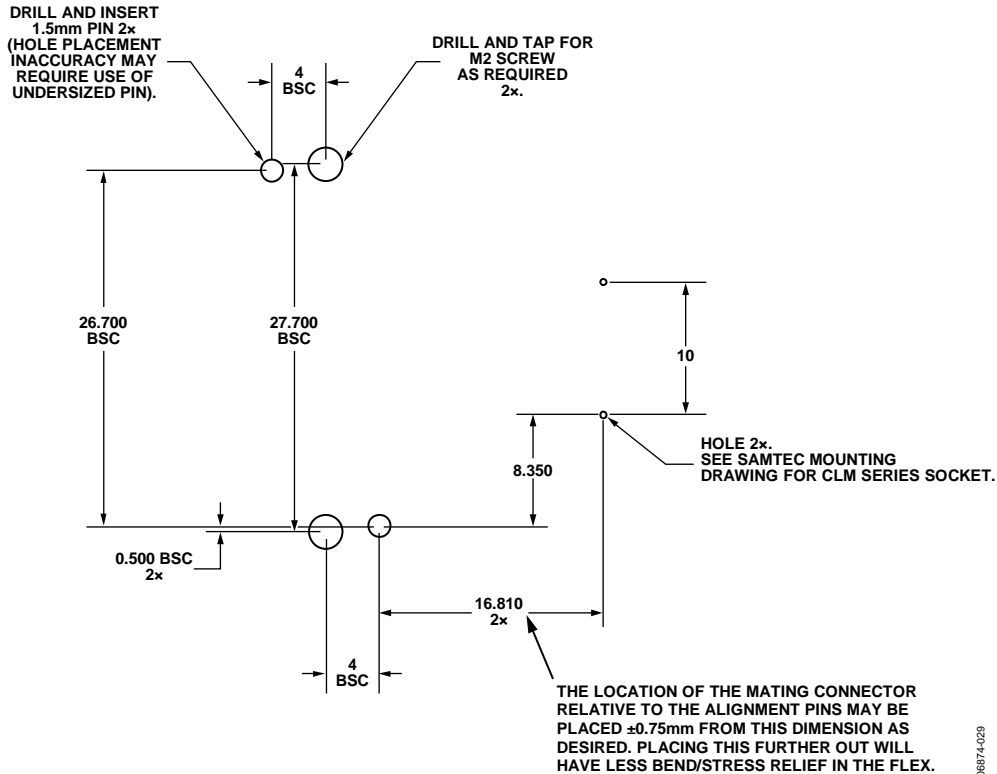

Figure 28. Mechanical Attachment

06874-028



08874-029

Figure 29. Hole Locations

ADIS16350/ADIS16355

OUTLINE DIMENSIONS

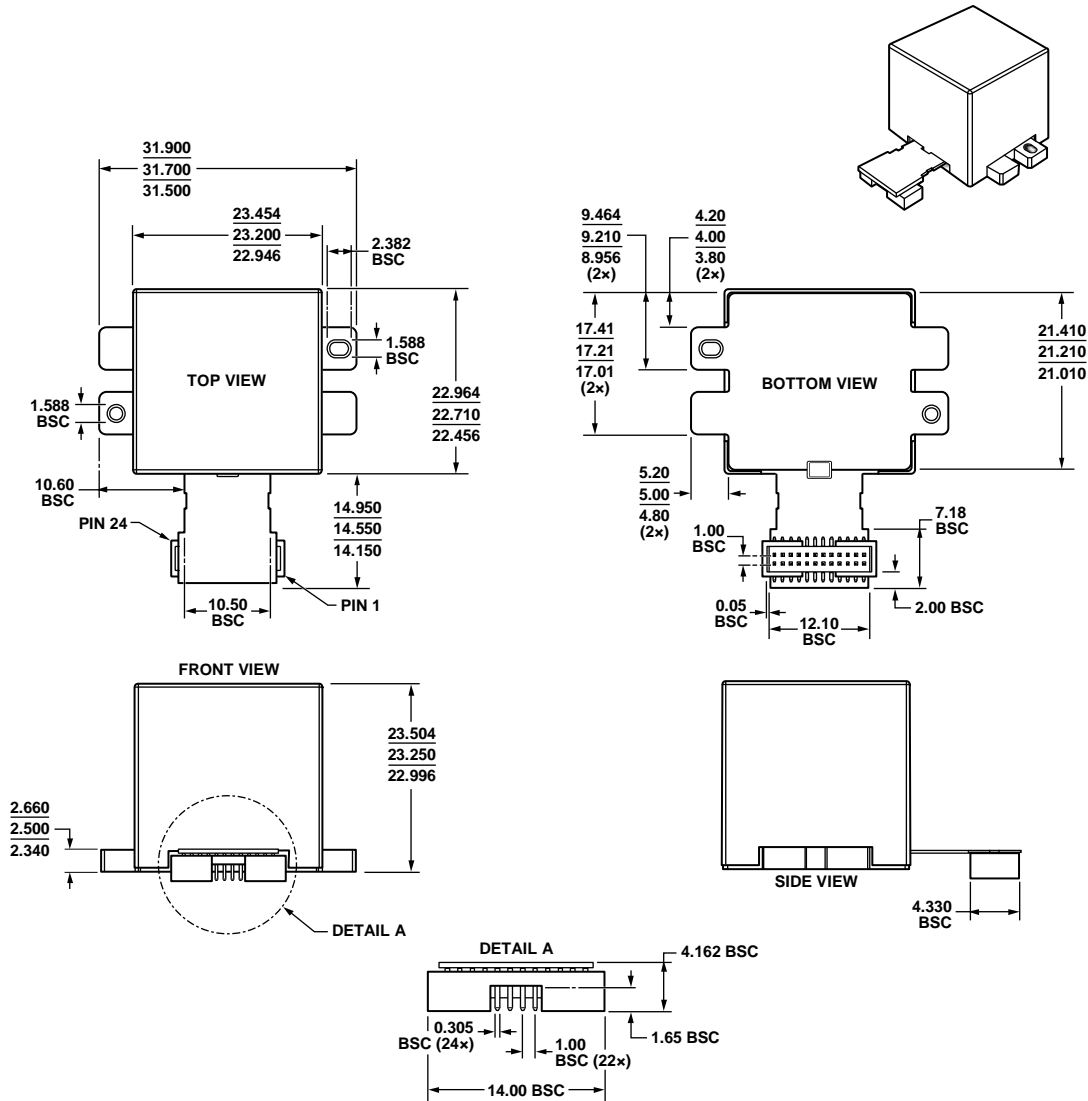

Figure 30. 24-Lead Module with Connector Interface (ML-24-2)
Dimensions shown in millimeters

01108-C

ORDERING GUIDE

Model	Temperature Range	Package Description	Package Option
ADIS16350AMLZ ¹	-40°C to +85°C	24-Lead Module with Connector Interface	ML-24-2
ADIS16350/PCBZ ¹		Interface Board	
ADIS16355AMLZ ¹	-40°C to +85°C	24-Lead Module with Connector Interface	ML-24-2
ADIS16355/PCBZ ¹		Interface Board	

¹ Z = RoHS Compliant Part.