

DATA SHEET

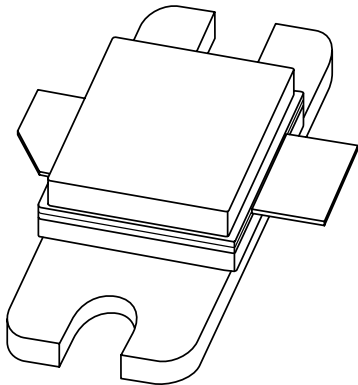

BLS3135-50 Microwave power transistor

Product specification
Supersedes data of 1999 Aug 16

2003 Apr 15

Microwave power transistor

BLS3135-50

FEATURES

- Suitable for short and medium pulse applications
- Internal input and output matching networks for an easy circuit design
- Emitter ballasting resistors improve ruggedness
- Gold metallization ensures excellent reliability
- Interdigitated emitter-base structure provides high emitter efficiency
- Multicell geometry improves power sharing and reduces thermal resistance.

APPLICATIONS

- Common base class-C pulsed power amplifiers for radar applications in the 3.1 to 3.5 GHz band.

DESCRIPTION

NPN silicon planar epitaxial microwave power transistor in a 2-lead rectangular flange package with a ceramic cap (SOT422A) with the common base connected to the flange.

PINNING - SOT422A

PIN	DESCRIPTION
1	collector
2	emitter
3	base; connected to flange

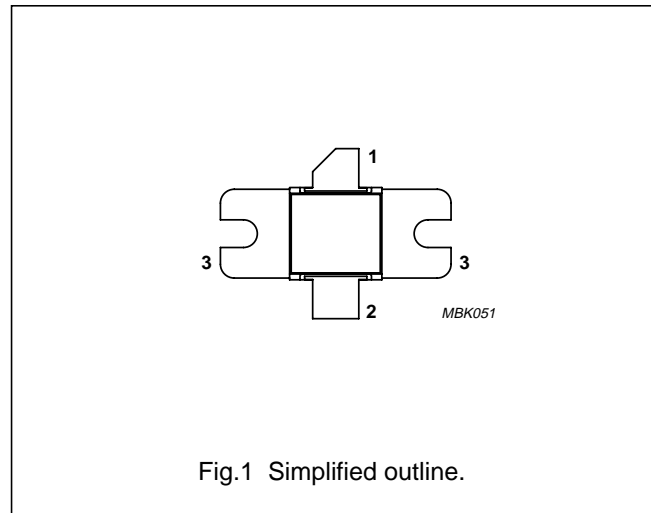

Fig.1 Simplified outline.

QUICK REFERENCE DATA

RF performance at $T_h = 25\text{ }^\circ\text{C}$ in a common base class-C test circuit.

MODE OF OPERATION	f (GHz)	V_{CB} (V)	P_L (W)	G_p (dB)	η_c (%)
Pulsed, class-C	3.1 to 3.5	40	50	typ. 8	typ. 40

WARNING

Product and environmental safety - toxic materials

This product contains beryllium oxide. The product is entirely safe provided that the BeO disc is not damaged. All persons who handle, use or dispose of this product should be aware of its nature and of the necessary safety precautions. After use, dispose of as chemical or special waste according to the regulations applying at the location of the user. It must never be thrown out with the general or domestic waste.

Microwave power transistor

BLS3135-50

LIMITING VALUES

In accordance with the Absolute Maximum Rating System (IEC 60134).

SYMBOL	PARAMETER	CONDITIONS	MIN.	MAX.	UNIT
V_{CBO}	collector-base voltage	open emitter	–	75	V
V_{CES}	collector-emitter voltage	$R_{BE} = 0$	–	75	V
V_{EBO}	emitter-base voltage	open collector	–	2	V
I_{CM}	peak collector current	$t_p \leq 100 \mu\text{s}$; $\delta \leq 10\%$	–	6	A
P_{tot}	total power dissipation	$t_p = 100 \mu\text{s}$; $\delta = 10\%$; $T_{mb} = 25 \text{ }^\circ\text{C}$	–	80	W
T_{stg}	storage temperature		–65	+200	$^\circ\text{C}$
T_j	operating junction temperature		–	200	$^\circ\text{C}$
T_{sld}	soldering temperature	up to 0.2 mm from ceramic cap; $t \leq 10 \text{ s}$	–	235	$^\circ\text{C}$

THERMAL CHARACTERISTICS

SYMBOL	PARAMETER	CONDITIONS	VALUE	UNIT
$Z_{th\ j-h}$	thermal impedance from junction to heatsink	$t_p = 100 \mu\text{s}$; $\delta = 10\%$; note 1	0.71	K/W
		$t_p = 300 \mu\text{s}$; $\delta = 10\%$; note 1	0.99	K/W

Note

1. Equivalent thermal impedance under pulsed microwave operating conditions. Measured with IR-scan with 20 μm spot size at hotspot.

CHARACTERISTICS

 $T_j = 25 \text{ }^\circ\text{C}$ unless otherwise specified.

SYMBOL	PARAMETER	CONDITIONS	MIN.	MAX.	UNIT
$V_{(BR)CBO}$	collector-base breakdown voltage	$I_C = 15 \text{ mA}$; open emitter	75	–	V
$V_{(BR)CES}$	collector-emitter breakdown voltage	$I_C = 15 \text{ mA}$; $V_{BE} = 0$	75	–	V
I_{CBO}	collector leakage current	$V_{CB} = 40 \text{ V}$; $I_E = 0$	–	1.5	mA
I_{CES}	collector leakage current	$V_{CE} = 40 \text{ V}$; $V_{BE} = 0$	–	3	mA
I_{EBO}	emitter leakage current	$V_{EB} = 1.5 \text{ V}$; $I_C = 0$	–	0.3	mA
h_{FE}	DC current gain	$V_{CB} = 5 \text{ V}$; $I_C = 1.5 \text{ A}$	40	–	

APPLICATION INFORMATION

RF performance at $T_h = 25 \text{ }^\circ\text{C}$ in a common-base test circuit.

MODE OF OPERATION	f (GHz)	V_{CE} (V)	P_L (W)	G_p (dB)	η_c (%)
Class-C; $t_p = 100 \mu\text{s}$; $\delta = 10\%$	3.1 to 3.5	40	≥ 50 typ. 55	≥ 7 typ. 8	≥ 35 typ. 40

Microwave power transistor

BLS3135-50

Typical impedance

FREQUENCY (GHZ)	Z_S (Ω)	Z_L (Ω)
3.1	23.5 - j 5.6	7.8 - j 3.7
3.2	23.6 - j 4.3	7.3 - j 4.1
3.3	23.8 - j 2.9	6.6 - j 4.3
3.4	24.3 - j 1.6	5.8 - j 4.2
3.5	24.9 - j 0.3	5.1 - j 4.1

Microwave power transistor

BLS3135-50

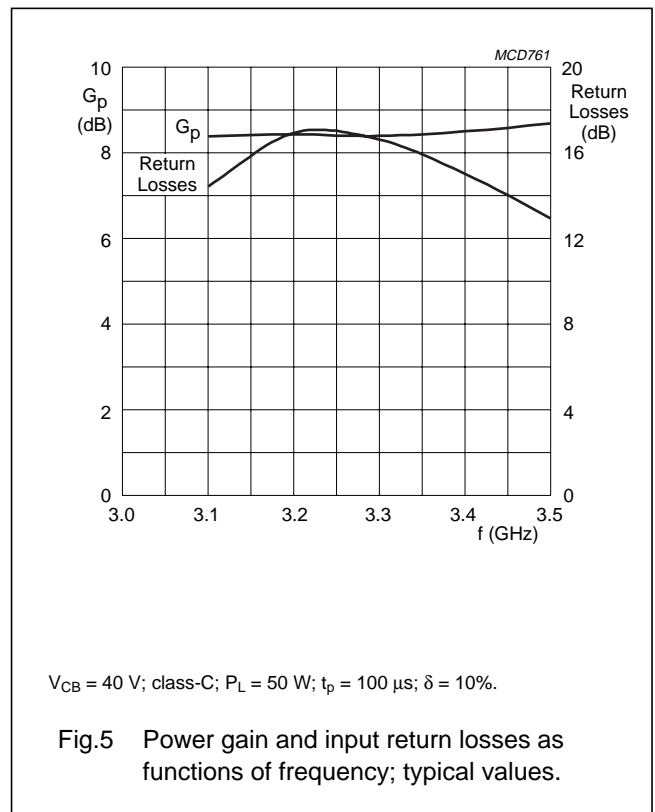
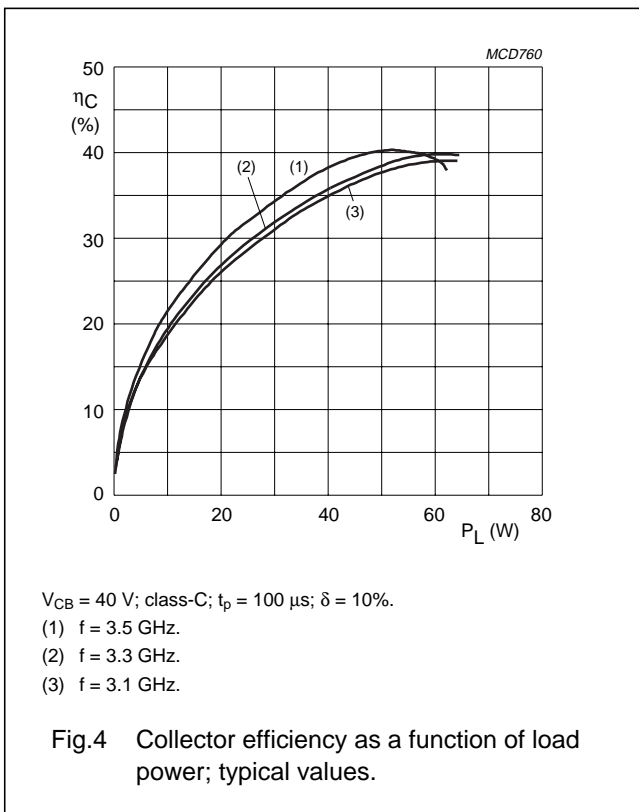
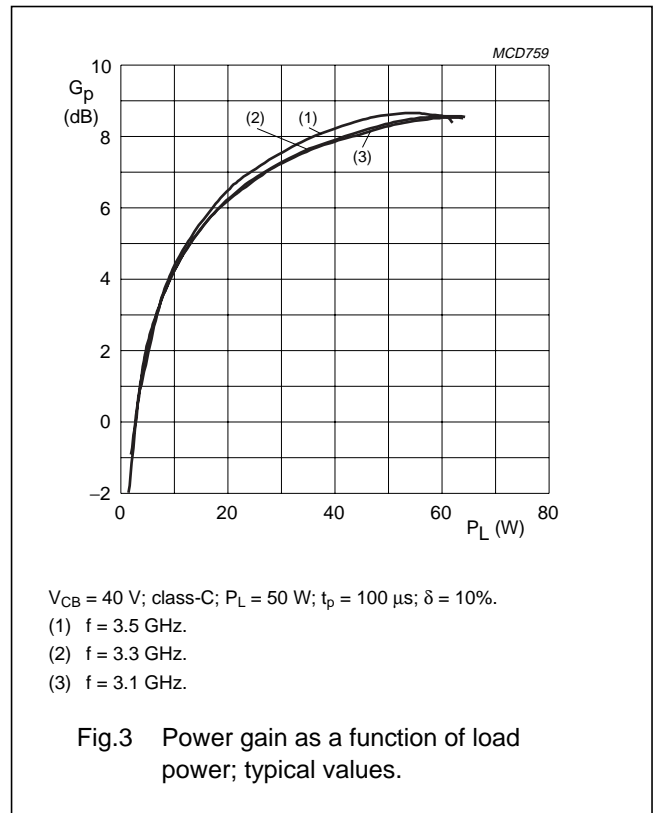
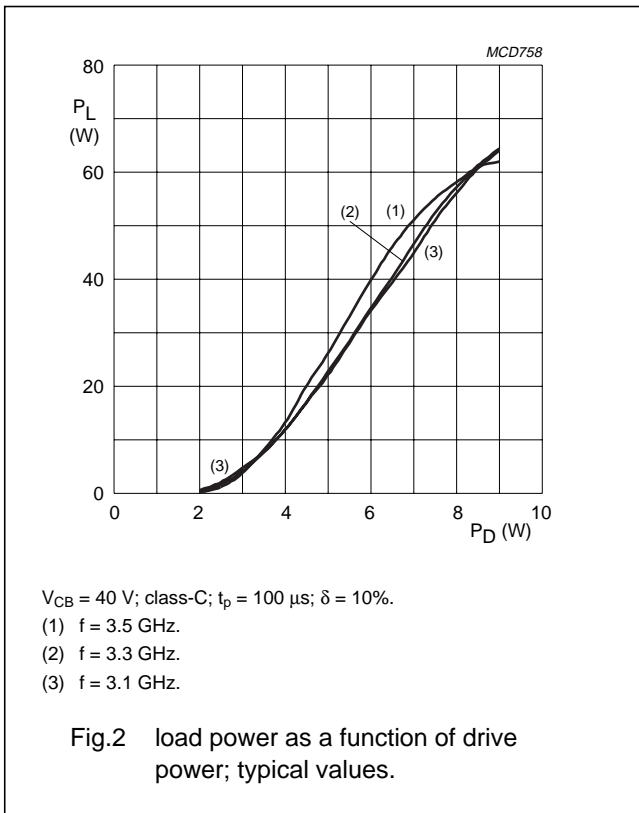

Microwave power transistor

BLS3135-50

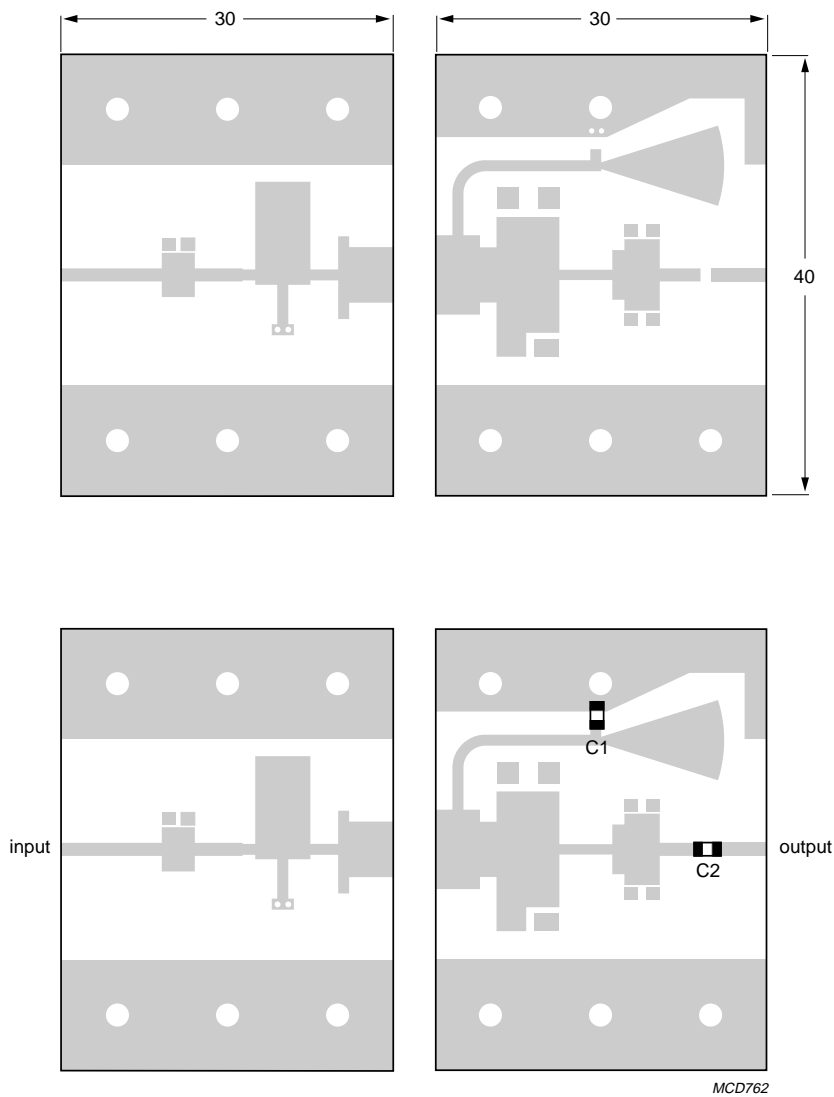

MCD762

Dimensions in mm.

The components are situated on one side of the copper-clad printed-circuit board with Duroid dielectric ($\epsilon_r = 2.2$), thickness 0.38 mm. The other side is unetched and serves as a ground plane.

C1 = C2 = ATC 100A 5.1 pF

Fig.6 Component layout for 3.1 to 3.5 GHz class-C test circuit.

Microwave power transistor

BLS3135-50

PACKAGE OUTLINE

Flanged hermetic ceramic package; 2 mounting holes; 2 leads

SOT422A

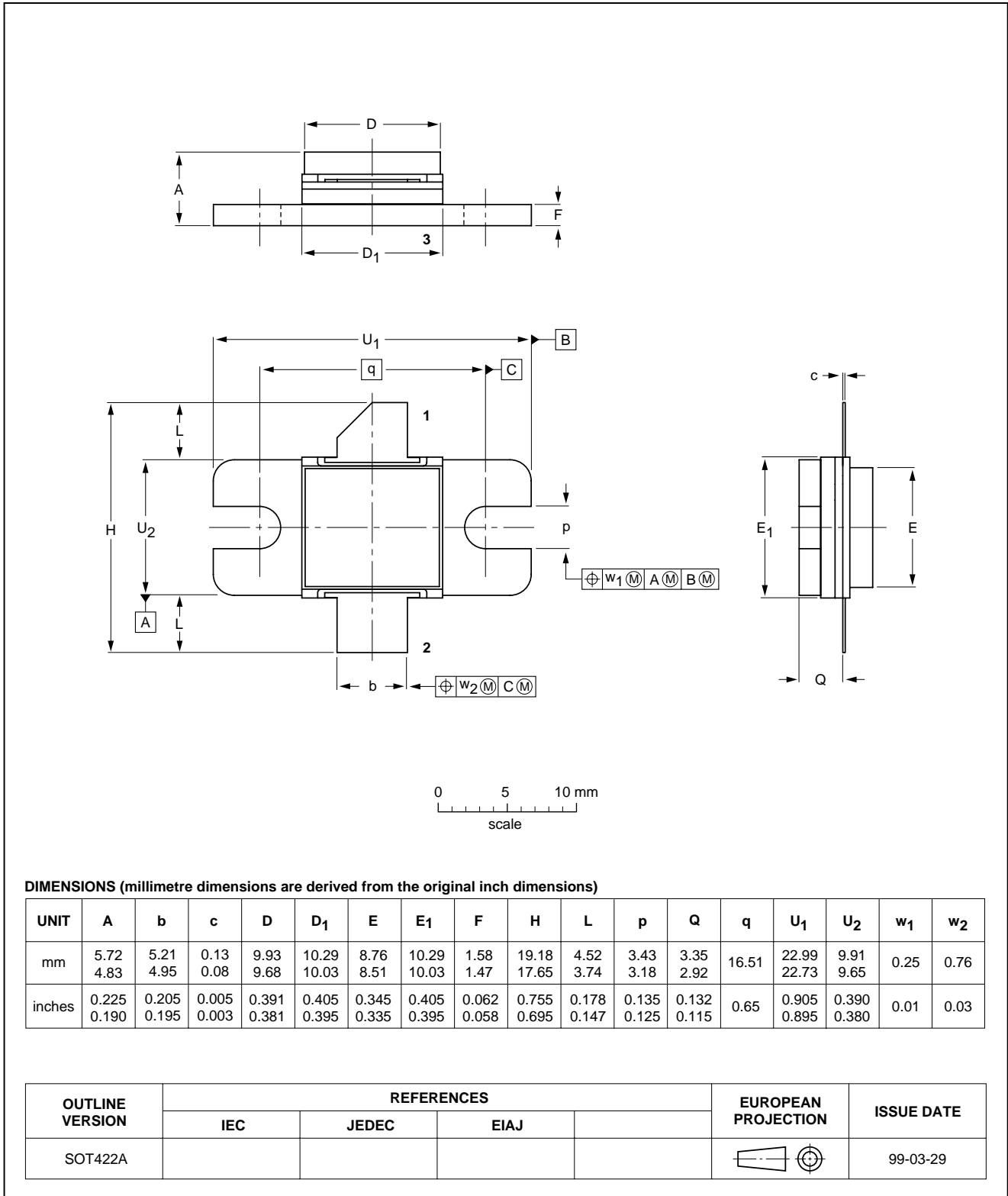

Microwave power transistor

BLS3135-50

DATA SHEET STATUS

LEVEL	DATA SHEET STATUS ⁽¹⁾	PRODUCT STATUS ⁽²⁾⁽³⁾	DEFINITION
I	Objective data	Development	This data sheet contains data from the objective specification for product development. Philips Semiconductors reserves the right to change the specification in any manner without notice.
II	Preliminary data	Qualification	This data sheet contains data from the preliminary specification. Supplementary data will be published at a later date. Philips Semiconductors reserves the right to change the specification without notice, in order to improve the design and supply the best possible product.
III	Product data	Production	This data sheet contains data from the product specification. Philips Semiconductors reserves the right to make changes at any time in order to improve the design, manufacturing and supply. Relevant changes will be communicated via a Customer Product/Process Change Notification (CPCN).

Notes

1. Please consult the most recently issued data sheet before initiating or completing a design.
2. The product status of the device(s) described in this data sheet may have changed since this data sheet was published. The latest information is available on the Internet at URL <http://www.semiconductors.philips.com>.
3. For data sheets describing multiple type numbers, the highest-level product status determines the data sheet status.

DEFINITIONS

Short-form specification — The data in a short-form specification is extracted from a full data sheet with the same type number and title. For detailed information see the relevant data sheet or data handbook.

Limiting values definition — Limiting values given are in accordance with the Absolute Maximum Rating System (IEC 60134). Stress above one or more of the limiting values may cause permanent damage to the device. These are stress ratings only and operation of the device at these or at any other conditions above those given in the Characteristics sections of the specification is not implied. Exposure to limiting values for extended periods may affect device reliability.

Application information — Applications that are described herein for any of these products are for illustrative purposes only. Philips Semiconductors make no representation or warranty that such applications will be suitable for the specified use without further testing or modification.

DISCLAIMERS

Life support applications — These products are not designed for use in life support appliances, devices, or systems where malfunction of these products can reasonably be expected to result in personal injury. Philips Semiconductors customers using or selling these products for use in such applications do so at their own risk and agree to fully indemnify Philips Semiconductors for any damages resulting from such application.

Right to make changes — Philips Semiconductors reserves the right to make changes in the products - including circuits, standard cells, and/or software - described or contained herein in order to improve design and/or performance. When the product is in full production (status 'Production'), relevant changes will be communicated via a Customer Product/Process Change Notification (CPCN). Philips Semiconductors assumes no responsibility or liability for the use of any of these products, conveys no licence or title under any patent, copyright, or mask work right to these products, and makes no representations or warranties that these products are free from patent, copyright, or mask work right infringement, unless otherwise specified.

Microwave power transistor

BLS3135-50

NOTES

Microwave power transistor

BLS3135-50

NOTES

Microwave power transistor

BLS3135-50

NOTES

Philips Semiconductors – a worldwide company

Contact information

For additional information please visit <http://www.semiconductors.philips.com>. Fax: **+31 40 27 24825**

For sales offices addresses send e-mail to: sales.addresses@www.semiconductors.philips.com.

© Koninklijke Philips Electronics N.V. 2003

SCA75

All rights are reserved. Reproduction in whole or in part is prohibited without the prior written consent of the copyright owner.

The information presented in this document does not form part of any quotation or contract, is believed to be accurate and reliable and may be changed without notice. No liability will be accepted by the publisher for any consequence of its use. Publication thereof does not convey nor imply any license under patent- or other industrial or intellectual property rights.

Printed in The Netherlands

613524/03/pp12

Date of release: 2003 Apr 15

Document order number: 9397 750 11151

Let's make things better.

**Philips
Semiconductors**



PHILIPS