

### ● Features:

1. Current transfer ratio (CTR: MIN. 50% at  $I_F=5\text{mA}$ ,  $V_{CE}=5\text{V}$ )
2. High input-output isolation voltage ( $V_{ISO}=5,000\text{Vrms}$ )
3. Response time ( $t_r$ : TYP.  $4\mu\text{s}$  at  $V_{CE}=2\text{V}$ ,  $I_C=2\text{mA}$ ,  $R_L=100\ \Omega$ )
4. VDE approved(NO.40007240)
5. UL/CUL approved(NO.E236324)
6. CQC approved(NO.CQC08001026994  
NO.CQC05001014257)
7. This product doesn't contain restriction substance, comply RoHS standard

### ● Description

1. The BPC-817 series are optically coupled isolators containing a GaAs light emitting diode and an NPN silicon phototransistor
2. The lead pitch is 2.54mm

### ● Applications:

1. Computer terminals.
2. System appliances, measuring instruments.
3. Registers, copiers, automatic vending machines.
4. Electric home appliances, such as fan heaters, etc.
5. Signal transmission between circuits of different potentials and impedances.

### ● Outline Dimensions

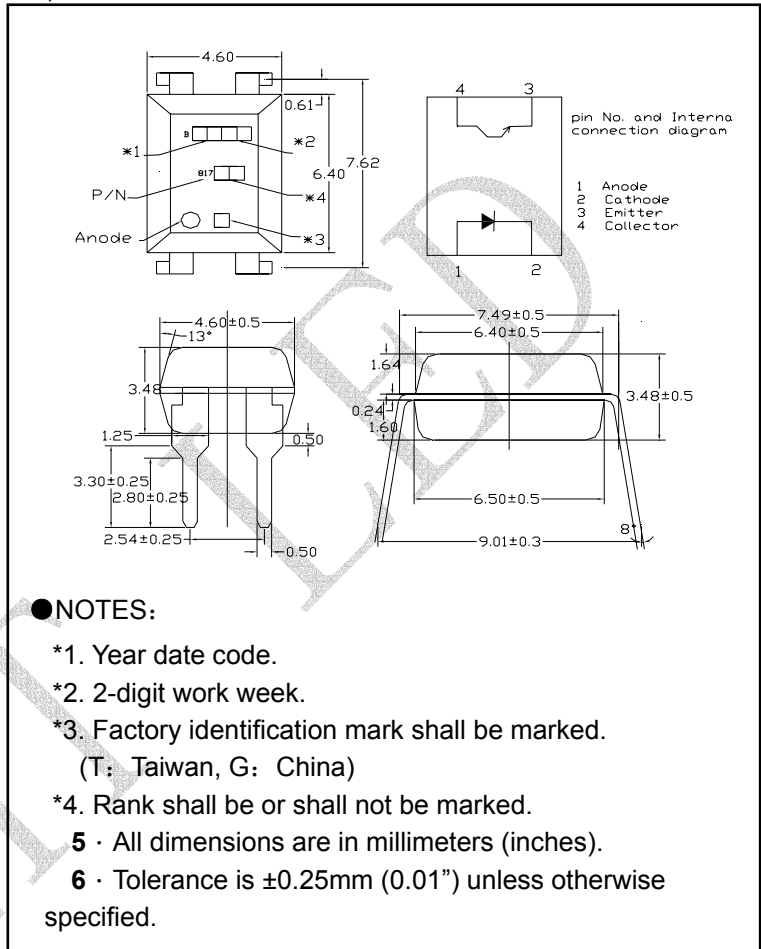

### ● Absolute Maximum Ratings ( $T_a=25^\circ\text{C}$ )

Parameter		Symbol	Rating	Unit
INPUT	Forward Current	$I_F$	50	mA
	Reverse Voltage	$V_R$	6	V
	Power Dissipation	P	70	mW
OUTPUT	Collector-Emitter Voltage	$V_{CEO}$	35	V
	Emitter- Collector Voltage	$V_{ECO}$	6	
	Collector Current	$I_C$	50	mA
	Collector Power Dissipation	$P_C$	150	mW
Total Power Dissipation		$P_{tot}$	200	mW
*1 Isolation Voltage		$V_{iso}$	5,000	Vrms
Rated impulse isolation voltage		$V_{IOTM}$	6,000	V
Rated repetitive peak isolation voltage		$V_{IORM}$	630	V
Operating Temperature		$T_{opr}$	-30 to + 110	°C
Storage Temperature		$T_{stg}$	-55 to + 125	
*2 Soldering Temperature		$T_{sol}$	260	

\*1. AC For 1 minute, R.H. =40~60%

Isolation voltage shall be measured using the following method.

- (1) Short between anode and cathode on the primary side and between collector and emitter on the secondary side.
- (2) The isolation voltage tester with zero-cross circuit shall be used.
- (3) The waveform of applied voltage shall be a sine wave.

\*2. For 10 Seconds



### ● Electro-Optical Characteristics (Ta=25°C)

Parameter		Symbol	Conditions	MIN.	TYP.	MAX.	Unit
INPUT	Forward Voltage	$V_F$	$I_F=20mA$	---	1.2	1.4	V
	Reverse Current	$I_R$	$V_R=6V$	---	---	10	$\mu A$
	Terminal Capacitance	$C_t$	$V=0, f=1KHz$	---	30	250	pF
OUTPUT	Collector Dark Current	$I_{CEO}$	$V_{CE}=20V, I_F=0$	---	---	100	nA
	Collector-Emitter Breakdown Voltage	$BV_{CEO}$	$I_C=0.1mA$ $I_F=0$	35	---	---	V
	Emitter-Collector Breakdown Voltage	$BV_{ECO}$	$I_E=10\mu A$ $I_F=0$	6	---	---	V
TRANSFER CHARACTERISTICS	Collector Current	$I_c$	$I_F=5mA$	2.5	---	30	mA
	*1 Current Transfer Ratio	CTR	$V_{CE}=5V$	50	---	600	%
	Collector-Emitter Saturation Voltage	$V_{CE(sat)}$	$I_F=20mA$ $I_C=1mA$	---	0.1	0.2	V
	Isolation Resistance	$R_{iso}$	DC500V 40~60%R.H.	$5 \times 10^{10}$	$1 \times 10^{11}$	---	$\Omega$
	Floating Capacitance	$C_f$	$V=0, f=1MHz$	---	0.6	1	pF
	Cut-Off Frequency	$f_c$	$V_{CE}=5V, I_C=2mA$ $R_L=100\Omega, -3dB$	---	80	---	kHz
	Response Time(Rise)	$t_r$	$V_{CE}=2V, I_C=2mA$	---	4	18	$\mu s$
	Response Time(Fall)	$t_f$	$R_L=100\Omega$	---	3	18	$\mu s$

\*1 CTR=  $I_C / I_F \times 100\%$

### ● RANK TABLE OF CURRENT TRANSFER RATIO(CTR)

RANK MARK.	Min. (%)	Max. (%)
L	50	100
A	80	160
B	130	260
C	200	400
D	300	600
L or A or B or C or D	50	600

### Notes:

\*1. Conditions:  $I_F=5mA, V_{CE}=5V, Ta=25^\circ C$ .

## ● CHARACTERISTICS CURVES

Fig.1 Forward Current vs. Ambient Temperature

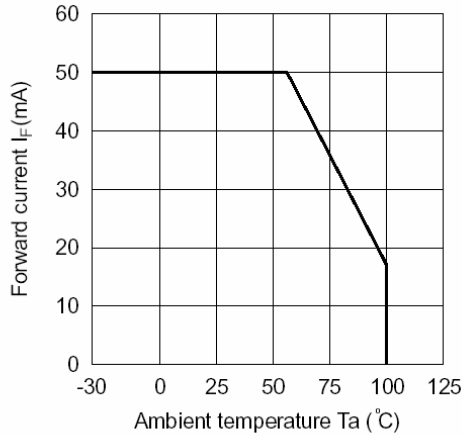

Fig.2 Collector Power Dissipation vs. Ambient Temperature

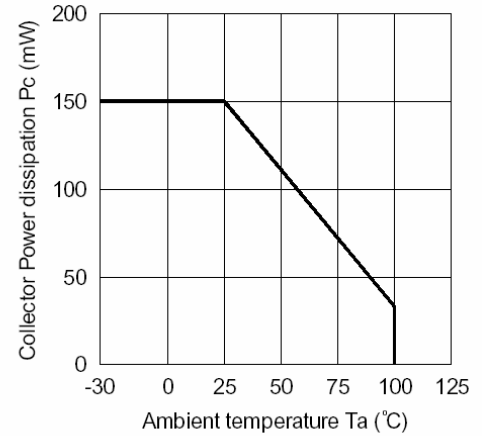

Fig.3 Collector-emitter Saturation Voltage vs. Forward Current

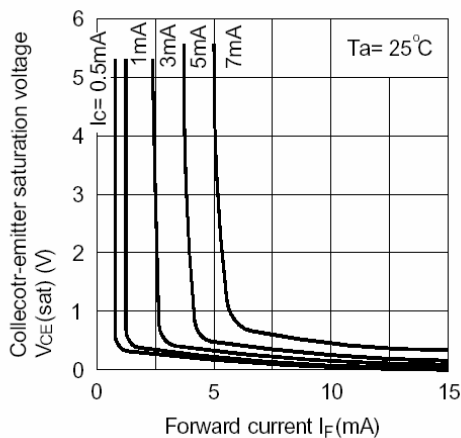

Fig.4 Forward Current vs. Forward Voltage

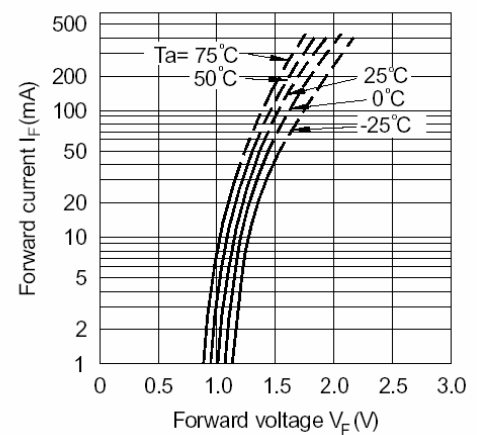

Fig.5 Current Transfer Ratio vs. Forward Current

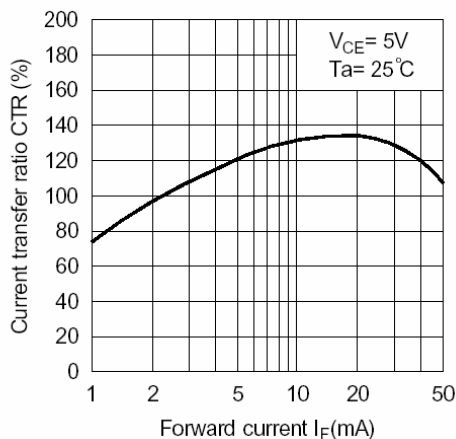
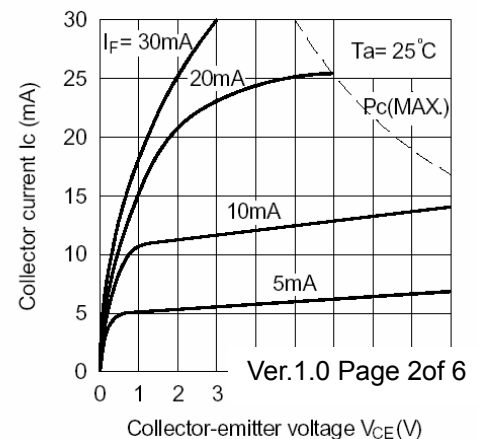

Fig.6 Collector Current vs. Collector-emitter Voltage



### ● Characteristics Curves

Fig.7 Relative Current Transfer Ratio vs. Ambient Temperature

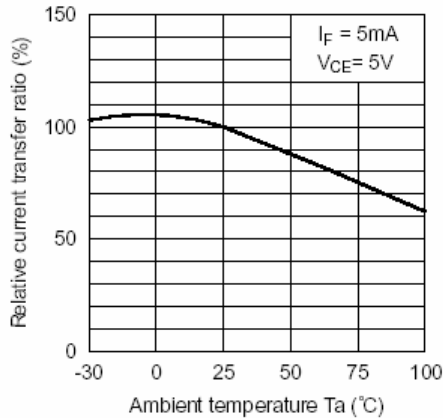

Fig.8 Collector-emitter Saturation Voltage vs. Ambient Temperature

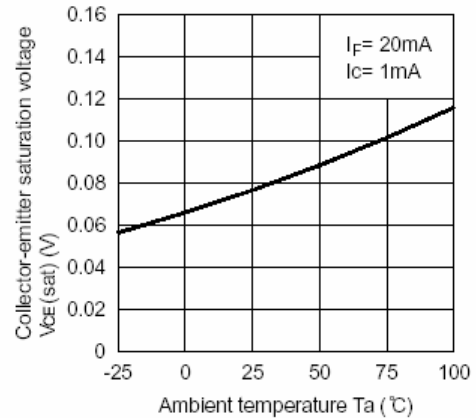

Fig.9 Collector Dark Current vs. Ambient Temperature

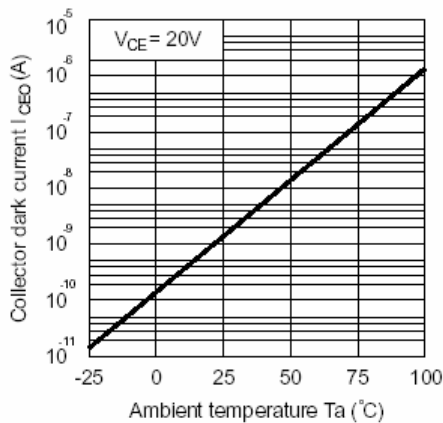

Fig.10 Response Time vs. Load Resistance

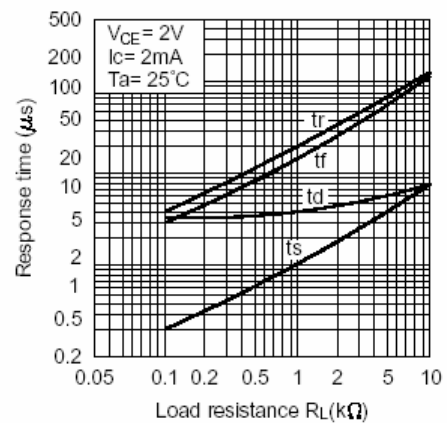
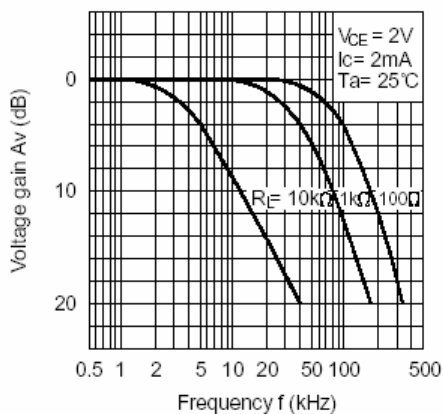
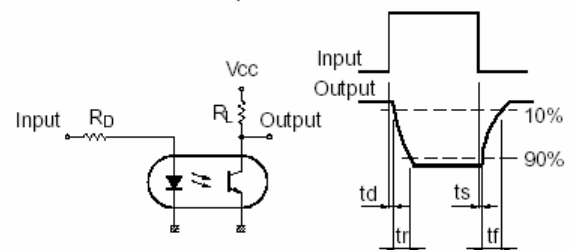

Fig.11 Frequency Response



Test Circuit for Response Time



Test Circuit for Frequency Response

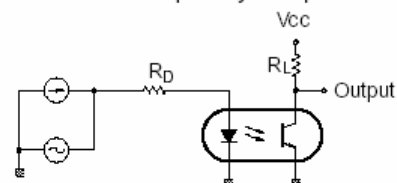

## ● Reliability Test

Classification	Test Item	Reference Standard	Test Conditions	Result
Endurance Test	Operation Life	MIL-STD-750:1026 MIL-STD-883:1005 JIS C 7021 :B-1	Connect with a power $I_f=50\text{mA}$ $T_a$ =Under room temperature Test time=1,000hrs	0/20
	High Temperature High Humidity Reverse Bias (H3TRB)	JIS C 7021 :B-11	$T_a=+85^\circ\text{C}\pm 5^\circ\text{C}$ , RH=85% PTR= $V_{CE}$ absolute max rating*80% Test time=1000hrs	0/20
	High Temperature Reverse Bias (HTRB)	JIS C 7021 :B- 8	$T_a=+105^\circ\text{C}\pm 5^\circ\text{C}$ PTR= $V_{CE}$ absolute max rating Test time=1000hrs	0/20
	High Temperature Storage	MIL-STD-883:1008 JIS C 7021 :B-10	High $T_a=+125^\circ\text{C}\pm 5^\circ\text{C}$ Test time=1,000hrs	0/20
	Low Temperature Storage	JIS-C-7021 :B-12	Low $T_a=-55^\circ\text{C}\pm 5^\circ\text{C}$ Test time=1,000hrs	0/20
	Autoclave	JESD 22-A102-B	P=15PSIG, $T_a=121^\circ\text{C}$ Humi. =100%RH, 48hrs	0/20
Environmental Test	Temperature Cycling	MIL-STD-202:107D MIL-STD-750:1051 MIL-STD-883:1010 JIS C 7021 :A-4	$125^\circ\text{C} \sim 25^\circ\text{C} \sim -55^\circ\text{C} \sim 25^\circ\text{C}$ 30min 5min 30min 5min Test Time=20cycle	0/20
	Thermal Shock	MIL-STD-202:107D MIL-STD-750:1051 MIL-STD-883:1011	$125^\circ\text{C} \sim -55^\circ\text{C}$ 20min 20min Test Time=20cycle	0/20
	Solder Resistance	MIL-STD-202:201A MIL-STD-750:2031 JIS C 7021 :A-1	Operation heating : $260^\circ\text{C}$ , within $10\pm 1$ seconds.	0/20
	Solder Ability	MIL-S-883:2003 JIS C 7021 :A-2	Operation heating : $235^\circ\text{C}$ , within $5\pm 1$ seconds.	0/20

## ● Judgment Criteria Of Failure For The Reliability

Symbol	Measuring conditions	Judgment criteria for failure
$V_F$ (V)	$I_f=20\text{mA}$	Over $U_x1.0$
$I_r$ ( $\mu\text{A}$ )	$V_r=6\text{V}$	Over $U_x1.0$
CTR(%)	$I_f=5\text{mA}$ , $V_{CE}=5\text{V}$	Shift>1.2
$V_{CE(sat)}$	$I_f=20\text{mA}$ , $I_c= 1\text{mA}$	Over $U_x1.0$
$BV_{CEO}$	$I_c=0.1\text{mA}$ , $I_f=0$	Over $L_x1.0$
$BV_{ECO}$	$I_E=10\mu\text{A}$ , $I_f=0$	Over $L_x1.0$

● Packaging Box Dimensions (Units: mm)

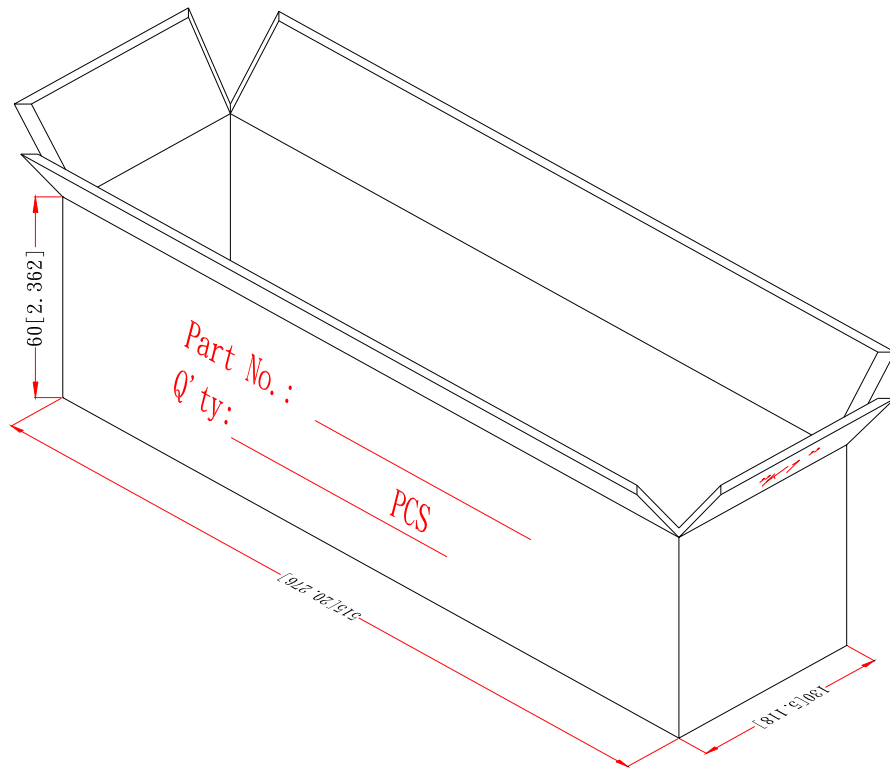

● Packaging Tube Dimensions

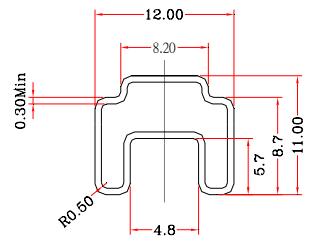
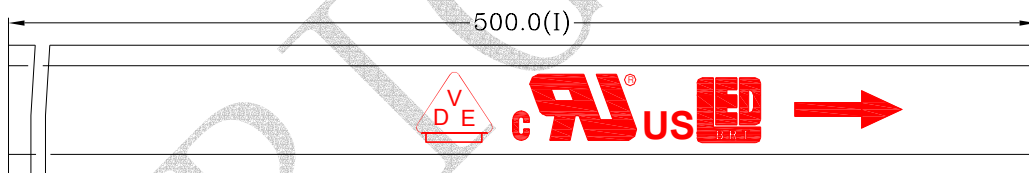

**Notes:**

- 1、100pcs per tube, 5Kpcs per box.
- 2、All dimensions are in millimeters (inches).
- 3、Specifications are subject to change without notice.