

EPC2100 – Enhancement-Mode GaN Power Transistor Half-Bridge

V_{DS} , 30 V

$R_{DS(on)}$, 8.2 mΩ (Q1), 2.1 mΩ (Q2)

I_D , 10 A (Q1), 40 A (Q2)

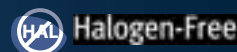

Gallium Nitride's exceptionally high electron mobility and low temperature coefficient allows very low $R_{DS(on)}$, while its lateral device structure and majority carrier diode provide exceptionally low Q_G and zero Q_{RR} . The end result is a device that can handle tasks where very high switching frequency, and low on-time are beneficial as well as those where on-state losses dominate.

Maximum Ratings

DEVICE	PARAMETER		VALUE	UNIT
Q1	V_{DS}	Drain-to-Source Voltage (Continuous)	30	V
		Drain-to-Source Voltage (up to 10,000 5 ms pulses at 150°C)	36	
	I_D	Continuous ($T_A = 25^\circ\text{C}$, $R_{\theta JA} = 92^\circ\text{C/W}$)	10	A
		Pulsed (25°C , $T_{PULSE} = 300 \mu\text{s}$)	100	
	V_{GS}	Gate-to-Source Voltage	6	V
		Gate-to-Source Voltage	-4	
	T_J	Operating Temperature	-40 to 150	°C
T_{STG}	Storage Temperature	-40 to 150		
Q2	V_{DS}	Drain-to-Source Voltage (Continuous)	30	V
		Drain-to-Source Voltage (up to 10,000 5 ms pulses at 150°C)	36	
	I_D	Continuous ($T_A = 25^\circ\text{C}$, $R_{\theta JA} = 22^\circ\text{C/W}$)	40	A
		Pulsed (25°C , $T_{PULSE} = 300 \mu\text{s}$)	400	
	V_{GS}	Gate-to-Source Voltage	6	V
		Gate-to-Source Voltage	-4	
	T_J	Operating Temperature	-40 to 150	°C
T_{STG}	Storage Temperature	-40 to 150		

Thermal Characteristics ($T_J = 25^\circ\text{C}$ unless otherwise stated)

PARAMETER		TYP	UNIT
$R_{\theta JC}$	Thermal Resistance, Junction-to-Case	0.4	°C/W
$R_{\theta JB}$	Thermal Resistance, Junction-to-Board	2.5	
$R_{\theta JA}$	Thermal Resistance, Junction-to-Ambient (Note 1)	42	

Note 1: $R_{\theta JA}$ is determined with the device mounted on one square inch of copper pad, single layer 2 oz copper on FR4 board. See https://epc-co.com/epc/documents/product-training/Appnote_Thermal_Performance_of_eGaN_FETs.pdf for details



EPC2100 eGaN® ICs are supplied only in passivated die form with solder bumps
Die Size: 6.05 mm x 2.3 mm

Applications

- High Frequency DC-DC
- Point-of-Load (POL) Converters

Benefits

- High Frequency Operation
- Ultra High Efficiency
- High Density Footprint

Static Characteristics ($T_J = 25^\circ\text{C}$ unless otherwise stated)

DEVICE	PARAMETER		TEST CONDITIONS	MIN	TYP	MAX	UNIT
Q1	BV_{DSS}	Drain-to-Source Voltage	$V_{GS} = 0\text{ V}, I_D = 0.3\text{ mA}$	30			V
	I_{DSS}	Drain-Source Leakage	$V_{DS} = 24\text{ V}, V_{GS} = 0\text{ V}$		0.004	0.2	mA
	I_{GSS}	Gate-to-Source Forward Leakage	$V_{GS} = 5\text{ V}$		0.007	3	mA
		Gate-to-Source Reverse Leakage	$V_{GS} = -4\text{ V}$		0.004	0.2	mA
	$V_{GS(TH)}$	Gate Threshold Voltage	$V_{DS} = V_{GS}, I_D = 4\text{ mA}$	0.8	1.3	2.5	V
	$R_{DS(on)}$	Drain-Source On Resistance	$V_{GS} = 5\text{ V}, I_D = 25\text{ A}$		6	8.2	m Ω
	V_{SD}	Source-Drain Forward Voltage	$I_S = 0.5\text{ A}, V_{GS} = 0\text{ V}$		1.8		V
Q2	BV_{DSS}	Drain-to-Source Voltage	$V_{GS} = 0\text{ V}, I_D = 1\text{ mA}$	30			V
	I_{DSS}	Drain-Source Leakage	$V_{DS} = 24\text{ V}, V_{GS} = 0\text{ V}$		0.015	0.8	mA
	I_{GSS}	Gate-to-Source Forward Leakage	$V_{GS} = 5\text{ V}$		0.03	9	mA
		Gate-to-Source Reverse Leakage	$V_{GS} = -4\text{ V}$		0.015	0.8	mA
	$V_{GS(TH)}$	Gate Threshold Voltage	$V_{DS} = V_{GS}, I_D = 16\text{ mA}$	0.8	1.3	2.5	V
	$R_{DS(on)}$	Drain-Source On Resistance	$V_{GS} = 5\text{ V}, I_D = 25\text{ A}$		1.5	2.1	m Ω
	V_{SD}	Source-Drain Forward Voltage	$I_S = 0.5\text{ A}, V_{GS} = 0\text{ V}$		1.7		V

Dynamic Characteristics

DEVICE	PARAMETER		TEST CONDITIONS	MIN	TYP	MAX	UNIT
Q1	C_{ISS}	Input Capacitance	$V_{DS} = 15\text{ V}, V_{GS} = 0\text{ V}$		395	475	pF
	C_{RSS}	Reverse Transfer Capacitance			15		
	C_{OSS}	Output Capacitance			290	435	
	$C_{OSS(ER)}$	Effective Output Capacitance, Energy Related (Note 2)	$V_{DS} = 0\text{ to }15\text{ V}, V_{GS} = 0\text{ V}$		371		
	$C_{OSS(TR)}$	Effective Output Capacitance, Time Related (Note 3)			404		
	Q_G	Total Gate Charge	$V_{DS} = 15\text{ V}, V_{GS} = 5\text{ V}, I_D = 25\text{ A}$		3.6	4.9	nC
	Q_{GS}	Gate-to-Source Charge	$V_{DS} = 15\text{ V}, I_D = 25\text{ A}$		1.3		
	Q_{GD}	Gate-to-Drain Charge			0.6		
	$Q_{G(TH)}$	Gate Charge at Threshold			0.9		
	Q_{OSS}	Output Charge	$V_{DS} = 15\text{ V}, V_{GS} = 0\text{ V}$		6.1	9.2	
	Q_{RR}	Source-Drain Recovery Charge			0		
Q2	C_{ISS}	Input Capacitance	$V_{DS} = 15\text{ V}, V_{GS} = 0\text{ V}$		1630	1960	pF
	C_{RSS}	Reverse Transfer Capacitance			64		
	C_{OSS}	Output Capacitance			1370	2060	
	$C_{OSS(ER)}$	Effective Output Capacitance, Energy Related (Note 2)	$V_{DS} = 0\text{ to }15\text{ V}, V_{GS} = 0\text{ V}$		1740		
	$C_{OSS(TR)}$	Effective Output Capacitance, Time Related (Note 3)			1900		
	Q_G	Total Gate Charge	$V_{DS} = 15\text{ V}, V_{GS} = 5\text{ V}, I_D = 25\text{ A}$		15	19	nC
	Q_{GS}	Gate-to-Source Charge	$V_{DS} = 15\text{ V}, I_D = 25\text{ A}$		4.8		
	Q_{GD}	Gate-to-Drain Charge			2.7		
	$Q_{G(TH)}$	Gate Charge at Threshold			3.4		
	Q_{OSS}	Output Charge	$V_{DS} = 15\text{ V}, V_{GS} = 0\text{ V}$		29	44	
	Q_{RR}	Source-Drain Recovery Charge			0		

Note 2: $C_{OSS(ER)}$ is a fixed capacitance that gives the same stored energy as C_{OSS} while V_{DS} is rising from 0 to 50% BV_{DSS} .

Note 3: $C_{OSS(TR)}$ is a fixed capacitance that gives the same charging time as C_{OSS} while V_{DS} is rising from 0 to 50% BV_{DSS} .

Figure 1a (Q1): Typical Output Characteristics at 25°C

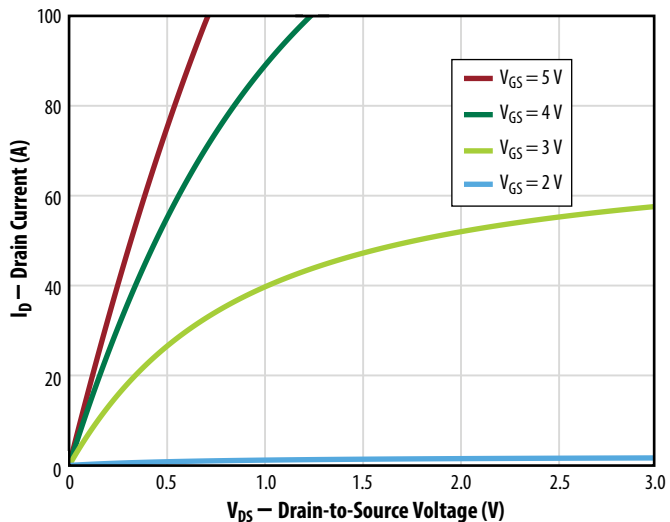

Figure 1b (Q2): Typical Output Characteristics at 25°C

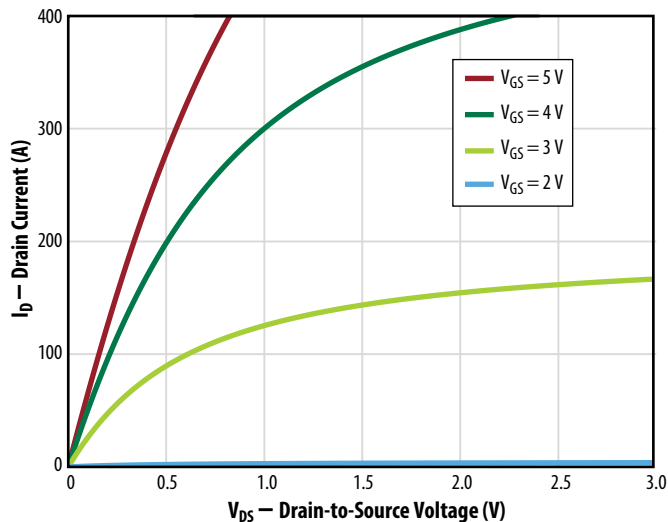

Figure 2a (Q1): Transfer Characteristics

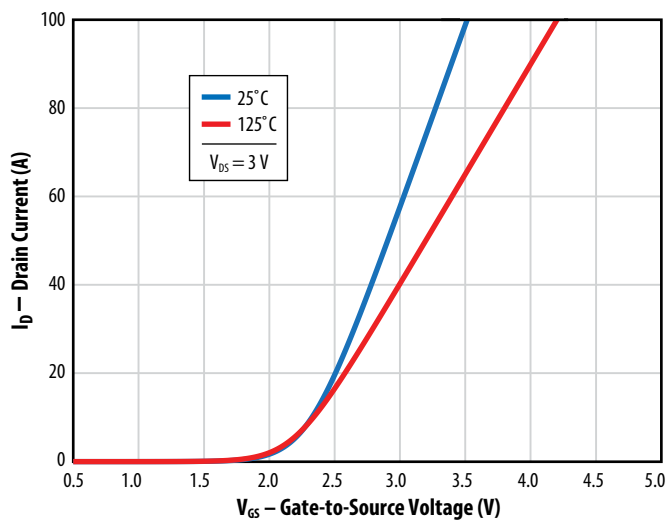

Figure 2b (Q2): Transfer Characteristics

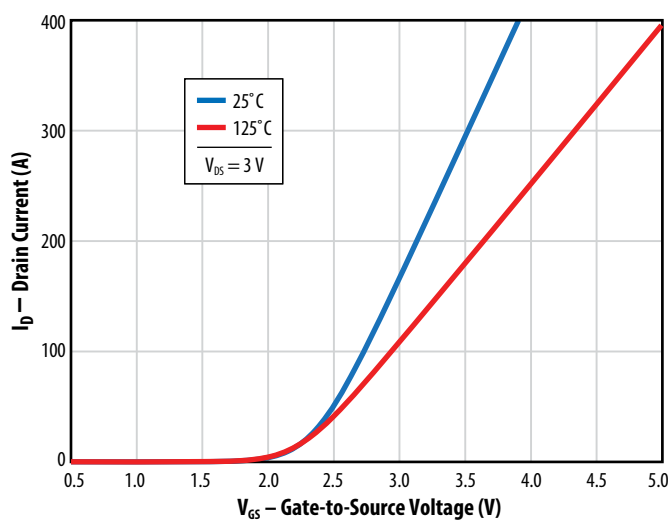

Figure 3a (Q1): $R_{DS(on)}$ vs. V_{GS} for Various Drain Currents

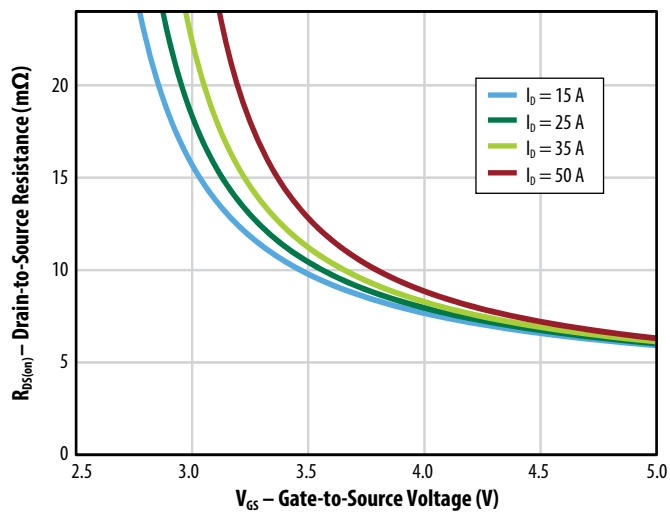

Figure 3b (Q2): $R_{DS(on)}$ vs. V_{GS} for Various Drain Currents

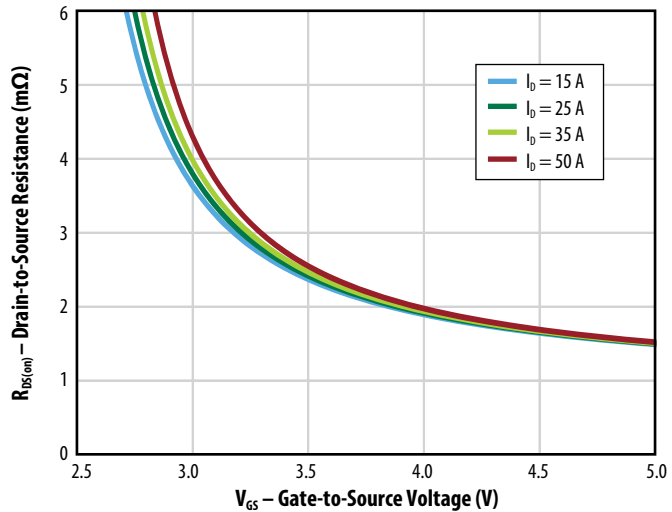

Figure 4a (Q1): $R_{DS(on)}$ vs. V_{GS} for Various Temperatures

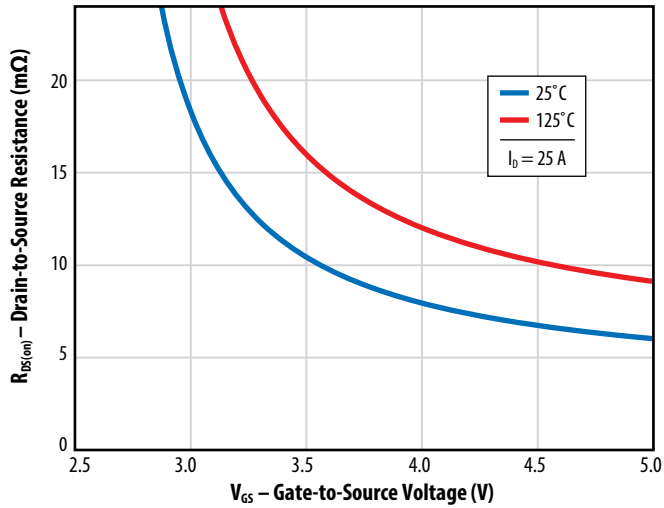

Figure 4b (Q2): $R_{DS(on)}$ vs. V_{GS} for Various Temperatures

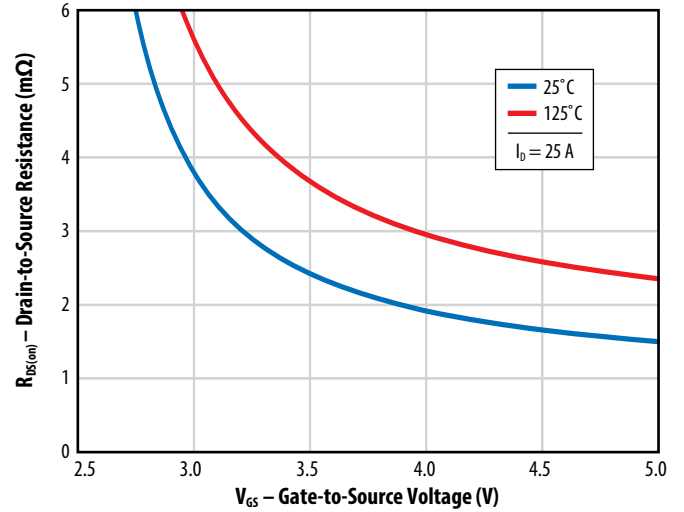

Figure 5a (Q1): Capacitance (Linear Scale)

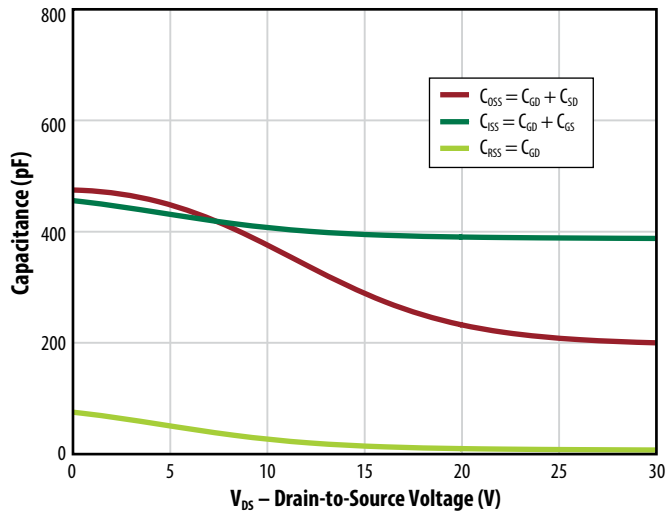

Figure 5b (Q1): Capacitance (Log Scale)

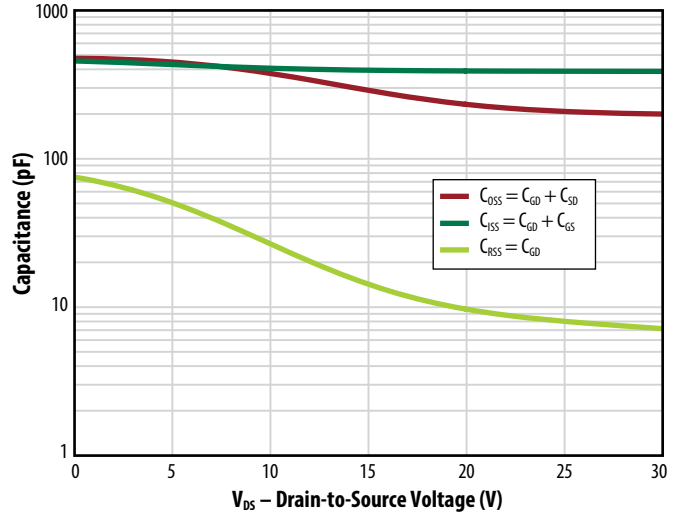

Figure 5c (Q2): Capacitance (Linear Scale)

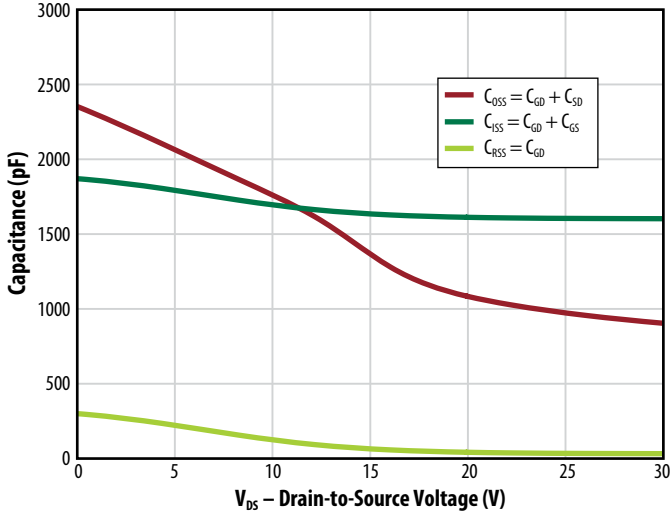

Figure 5d (Q2): Capacitance (Log Scale)

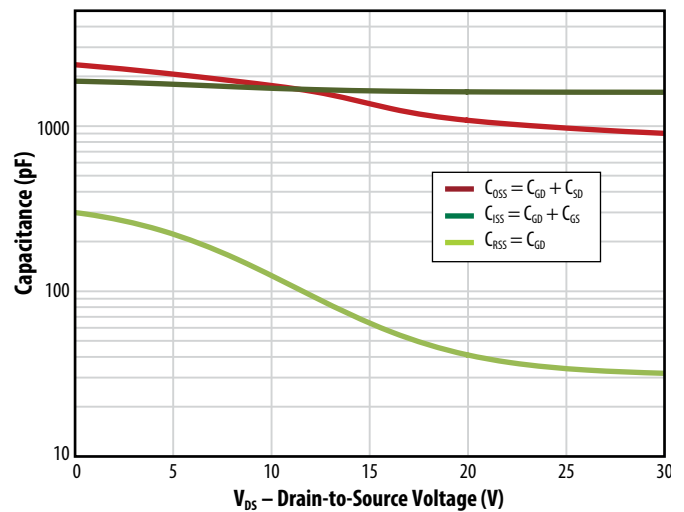

Figure 6a (Q1): Output Charge and C_{OSS} Stored Energy

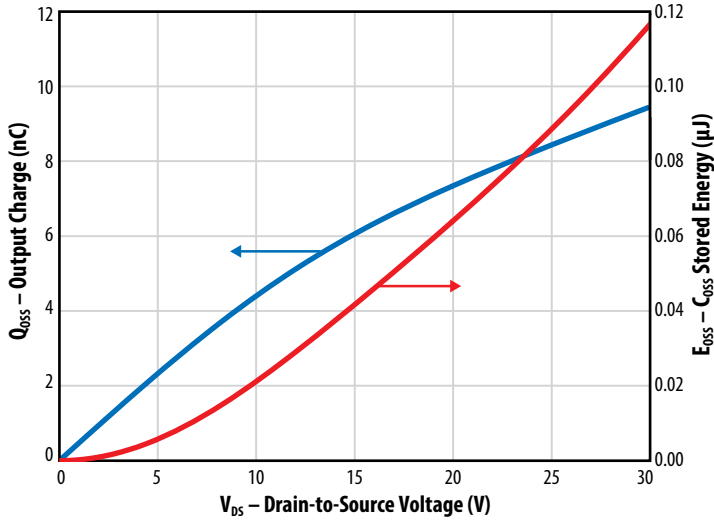

Figure 6b (Q2): Output Charge and C_{OSS} Stored Energy

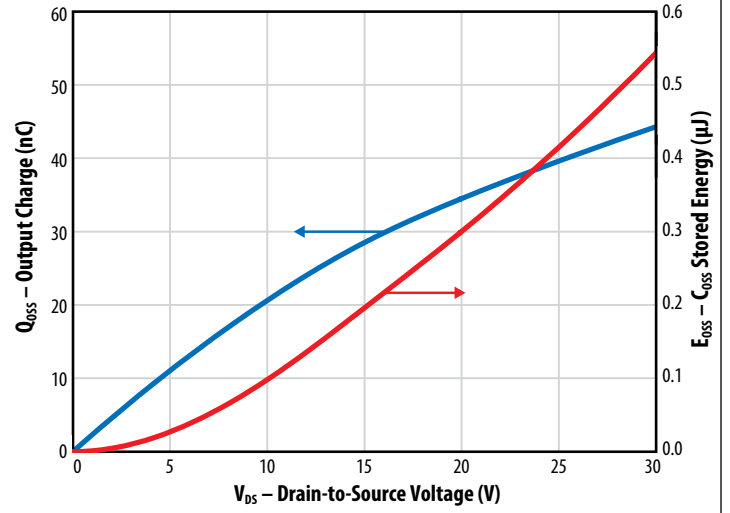

Figure 7a (Q1): Gate Charge

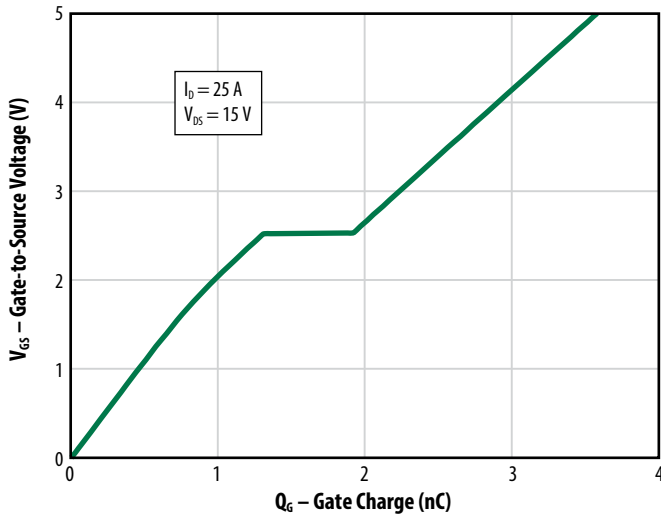

Figure 7b (Q2): Gate Charge

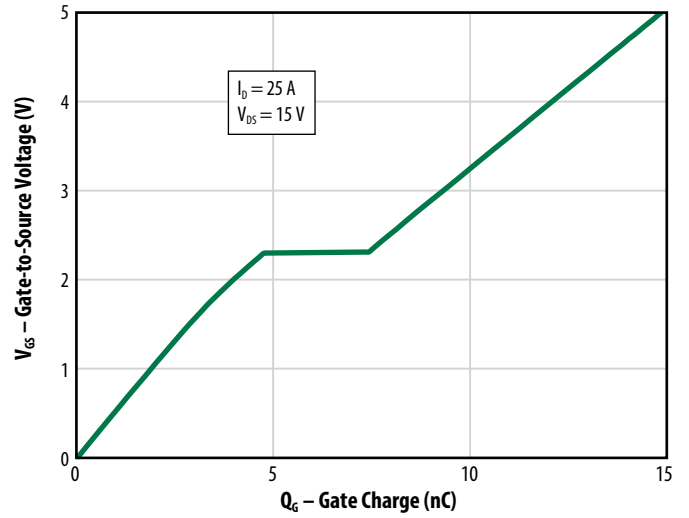

Figure 8a (Q1): Reverse Drain-Source Characteristics

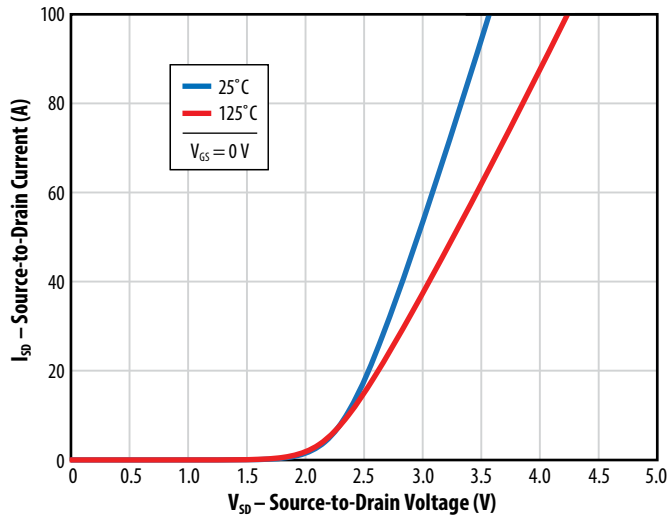

Figure 8b (Q2): Reverse Drain-Source Characteristics

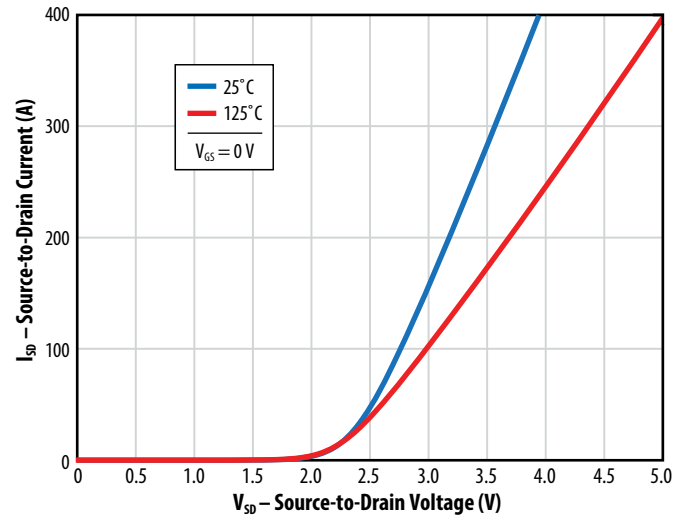

Figure 9a (Q1):
Normalized On-State Resistance vs. Temperature

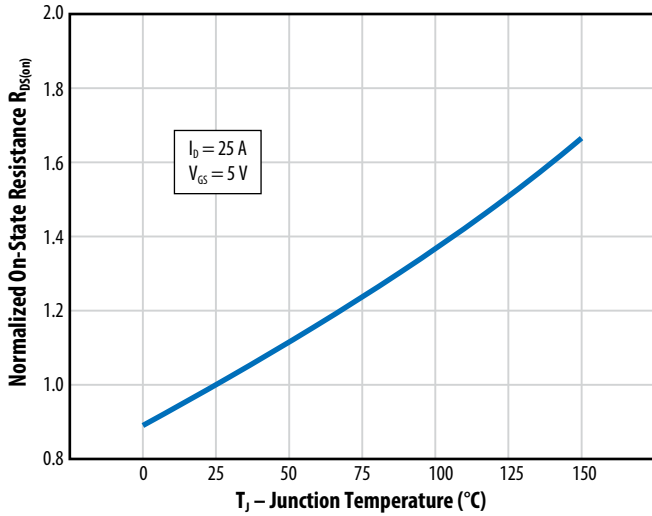

Figure 9b (Q2):
Normalized On-State Resistance vs. Temperature

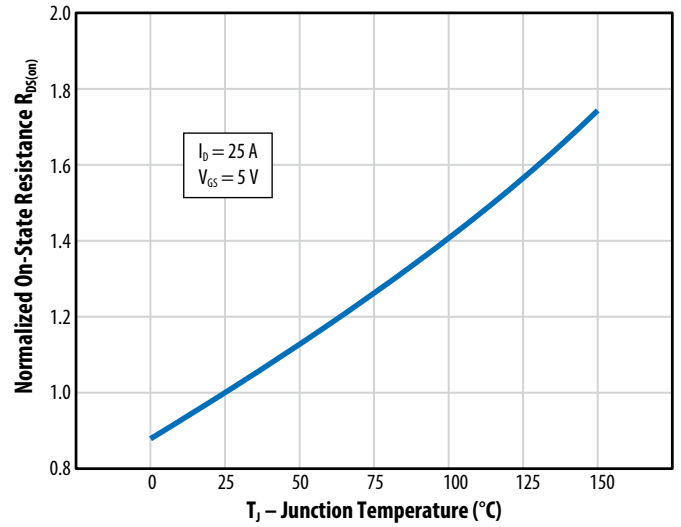

Figure 10a (Q1):
Normalized Threshold Voltage vs. Temperature

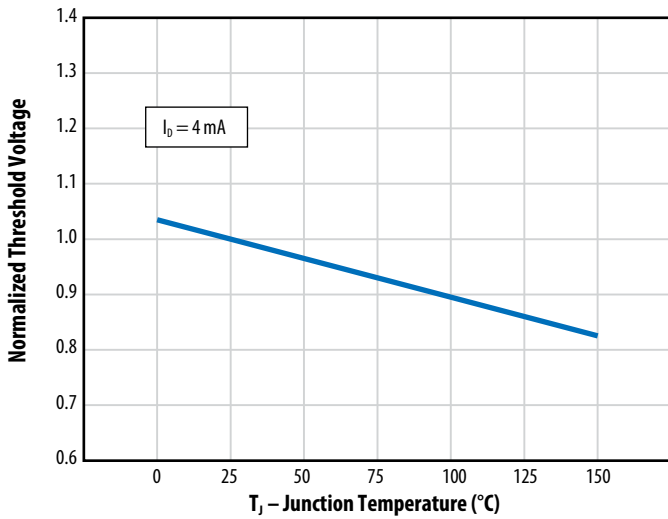

Figure 10b (Q2):
Normalized Threshold Voltage vs. Temperature

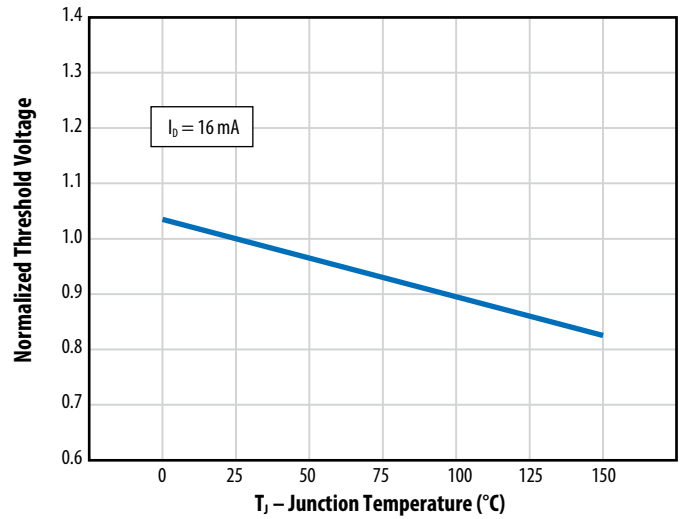

Figure 11a (Q1): Safe Operating Area

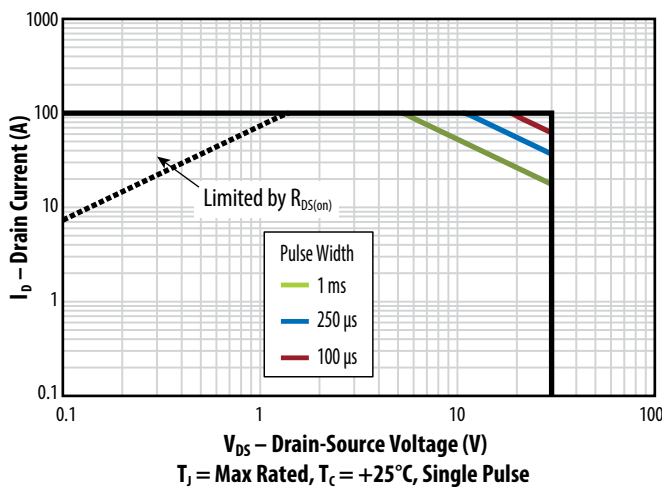

Figure 11b (Q2): Safe Operating Area

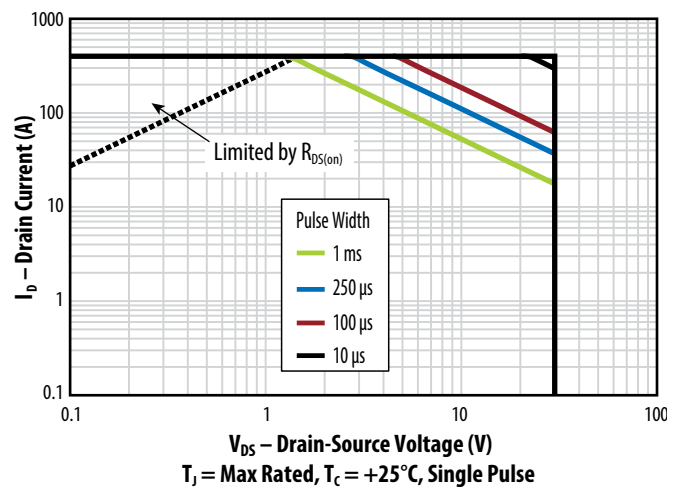

Figure 12a
Transient Thermal
Response Curves

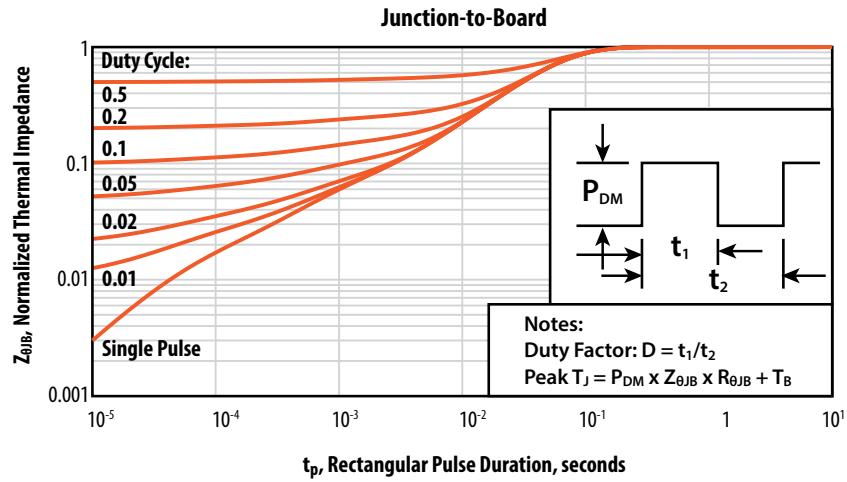

Figure 12b
Transient Thermal
Response Curves

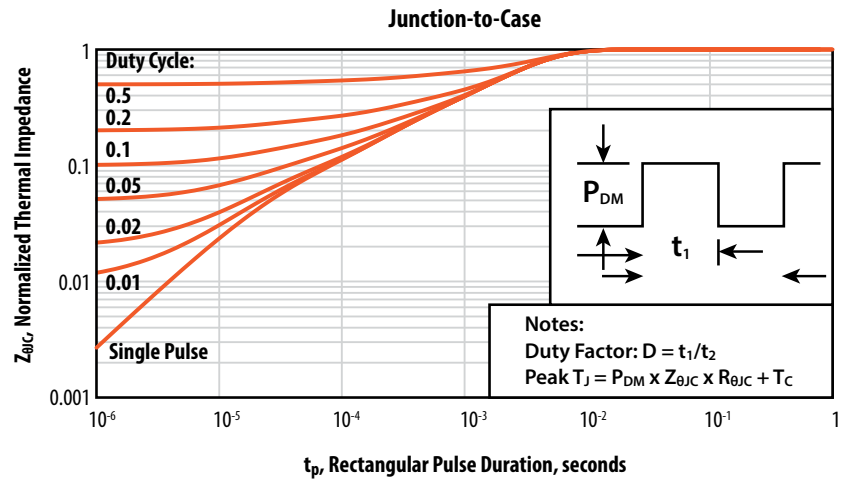
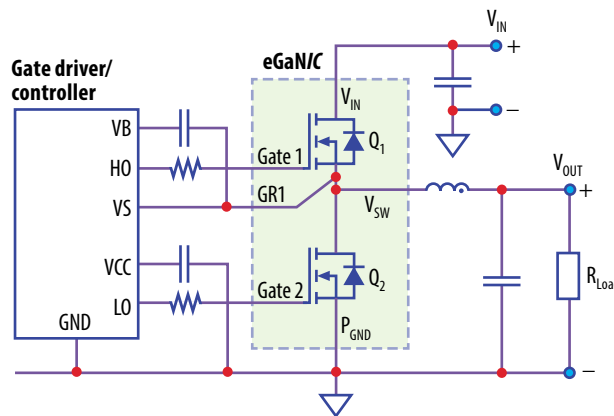
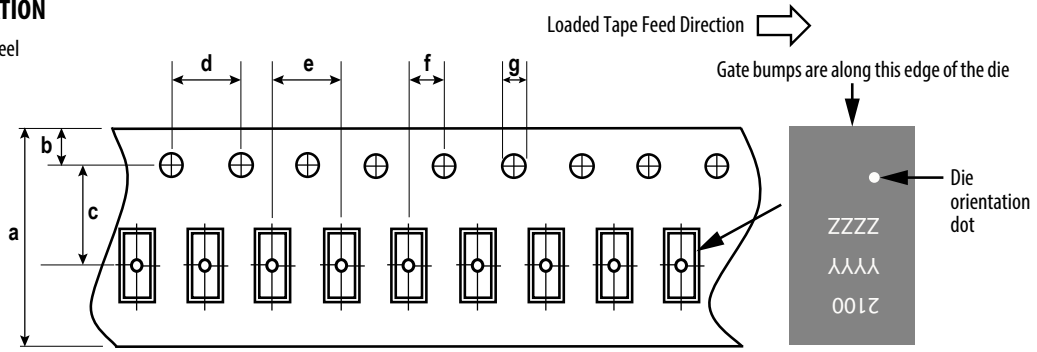
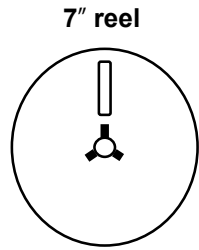

Figure 13
Typical Application Circuit



TAPE AND REEL CONFIGURATION

4mm pitch, 12mm wide tape on 7" reel



Die is placed into pocket solder ball side down (face side down)

EPC2100 (note 1)			
Dimension (mm)	target	min	max
a	12.00	11.70	12.30
b	1.75	1.65	1.85
c (see note)	5.50	5.45	5.55
d	4.00	3.90	4.10
e	4.00	3.90	4.10
f (see note)	2.00	1.95	2.05
g	1.50	1.50	1.60

Note 1: MSL 1 (moisture sensitivity level 1) classified according to IPC/JEDEC industry standard.
 Note 2: Pocket position is relative to the sprocket hole measured as true position of the pocket, not the pocket hole.

DIE MARKINGS

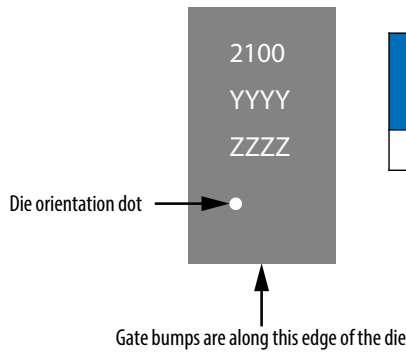

Part Number	Laser Markings		
	Part # Marking Line 1	Lot_Date Code Marking Line 2	Lot_Date Code Marking Line 3
EPC2100	2100	YYYY	ZZZZ

DIE OUTLINE

Solder Bump View

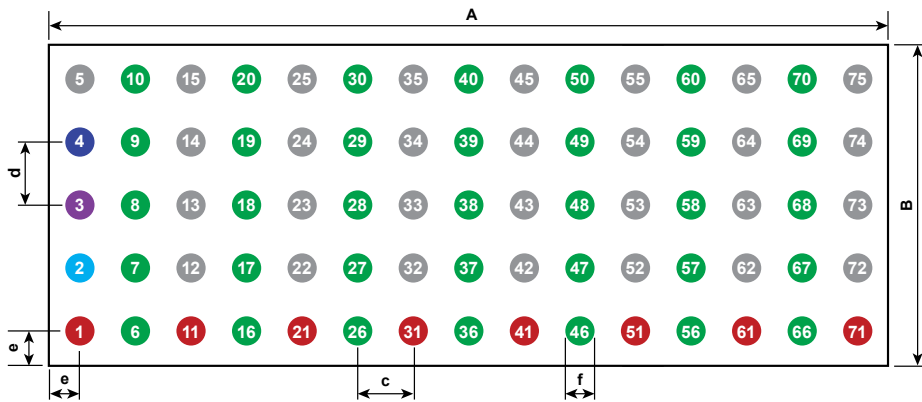

DIM	MIN	Nominal	MAX
A	6020	6050	6080
B	2270	2300	2330
c	400	400	400
d	450	450	450
e	210	225	240
f	187	208	240

Pad 2 is Gate1 (high side); Pad 4 is Gate2 (low side); Pad 3 is HS Gate Return;

Pads 5, 12, 13, 14, 15, 22, 23, 24, 25, 32, 33, 34, 35, 42, 43, 44, 45, 52, 53, 54, 55, 62, 63, 64, 65, 72, 73, 74, 75 are Ground;

Pads 1, 11, 21, 31, 41, 51, 61, 71 are V_{IN} ;

Pads 6, 7, 8, 9, 10, 16, 17, 18, 19, 20, 26, 27, 28, 29, 30, 36, 37, 38, 39, 40, 46, 47, 48, 49, 50, 56, 57, 58, 59, 60, 66, 67, 68, 69, 70 are Switch Node

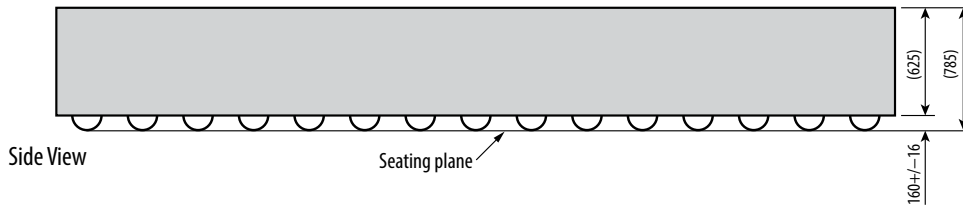

RECOMMENDED LAND PATTERN

(measurements in μm)

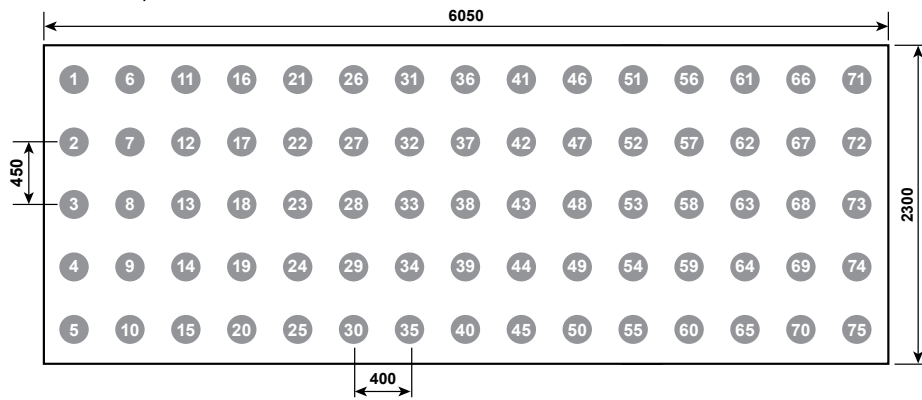

The land pattern is solder mask defined. Suggest SMD Pads at $200 +20/-10 \mu\text{m}$. $190 \mu\text{m}$ minimum.

RECOMMENDED STENCIL DRAWING

(measurements in μm)

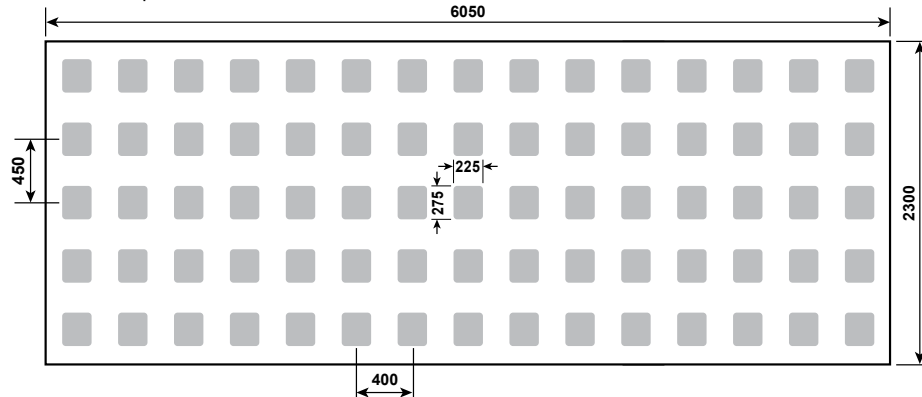

Recommended stencil should be 4 mil (100 μm) thick, must be laser cut, openings per drawing.

Intended for use with SAC305 Type 4 solder, reference 88.5% metals content.

Additional assembly resources available at: <https://epc-co.com/epc/DesignSupport/AssemblyBasics.aspx>

Efficient Power Conversion Corporation (EPC) reserves the right to make changes without further notice to any products herein to improve reliability, function or design. EPC does not assume any liability arising out of the application or use of any product or circuit described herein; neither does it convey any license under its patent rights, nor the rights of others.

eGaN® is a registered trademark of Efficient Power Conversion Corporation.
EPC Patent Listing: epc-co.com/epc/AboutEPC/Patents.aspx

Information subject to change without notice.

Revised August 2019