

2/4-CH Modular Type, PID Control Temperature Controller

■ Features

- Multi-channel (4-channel: TM4 / 2-channel: TM2) input and output control
- High-speed sampling cycle (4-channel: 100 ms / 2-channel: 50 ms)
- **Module connection and expansion with expansion connectors**
 - **Communication between modules**
 - **No additional power supply wiring**
 - **Expandable up to 31 units (124-channel / 62-channel)**
- Simultaneous heating and cooling control function
- Isolated input channels (dielectric strength: 1000 VAC)
- Switch between current output and SSR drive output (TM2-□2C□ models)
- SSR drive output (SSRP function) control options: ON/OFF control, cycle control, phase control
- Parameter configuration via PC (USB and RS485 communication)
 - DAQMaster software included (comprehensive device management software)
 - Communication converter sold separately: SCM-WF48 (Wi-Fi to RS485·USB wireless communication converter), SCM-US48I (USB to RS485 converter), SCM-38I (RS232C to RS485 converter), SCM-US (USB to serial converter)
- Easy wiring and maintenance with various connectors: sensor input connector, control output connector, power/communication connector
- Heater disconnect alarm function (CT input)
 - Current transformer (CT) sold separately: CSTC-E80LN, CSTC-E200LN, CSTS-E80PP
- Various input types and temperature ranges



⚠ Please read "Safety Considerations" in the instruction manual before using.



■ Manual

- Visit our website (www.autonics.com) to download user manual and communication manual.
- User manual describes for specifications and function, and communication manual describes for RS485 communication (Modbus RTU protocol) and parameter address map data.

■ Comprehensive Device Management Program (DAQMaster)

- DAQMaster is comprehensive device management program for convenient management of parameters and multiple device data monitoring.
- Visit our website (www.autonics.com) to download user manual and comprehensive device management program.

< Computer specification for using software >

Item	Minimum requirements
System	IBM PC compatible computer with Intel Pentium III or above
Operations	Microsoft Windows 98/NT/XP/Vista/7/8/10
Memory	256MB+
Hard disk	1GB+ of available hard disk space
VGA	Resolution: 1024×768 or higher
Others	RS-232 serial port (9-pin), USB port

< DAQMaster screen >

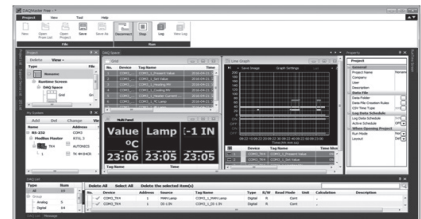





■ Ordering Information

Item	Channels	Option I/O	Power supply	Control output	Module type	
TM	4	N	2	R	B	Basic module
					E	Expansion module ^{※1}
				2CH	R	Relay output
					C	Current or SSR drive output selectable
				4CH	R	Relay output
					S	SSR drive output
			2		24VDC	
				2CH	2	CT input, Digital input (DI-1, DI-2), Alarm output 1+2, RS485 comm. output
					4	CT input, Digital input (DI-1, DI-2), Alarm output 1+2+3+4, RS485 comm. output
				4CH	N	RS485 comm. output
	2					2-channel
	4					4-channel
					TM	Multi-channel modular temperature controller

※1 The expansion module does not supply power/comm. terminal. Order it with the basic module.

2/4-CH Modular Type, PID Control

■ Specifications

Series	TM2	TM4	
No. of channels	2-channel (insulated each channel-dielectric strength 1,000VAC)	4-channel (insulated each channel-dielectric strength 1,000VAC)	
Power supply	24VDC=		
Permissible voltage range	90 to 110% of rated voltage		
Power consumption	Max. 5W (for max. load)		
Display method	None- parameter setting and monitoring is available at external devices (PC, PLC, etc.)		
Input type	Thermocouple	K(CA), J(IC), E(CR), T(CC), B(PR), R(PR), S(PR), N(NN), C(TT), G, (TT), L(IC), U(CC), Platinel II	
	RTD	JPt100Q, DPt100Q (permissible line resistance max. 5Ω)	
Sampling period	50ms (2 channel synchronous sampling)	100ms (4 channel synchronous sampling)	
Measured accuracy	Thermocouple ^{※1}	(PV ±0.5% or ±1°C, select the higher one) ±1-digit max.	
	RTD		
	CT input	±5% F.S. ±1-digit max.	—
	Current output	±1.5% F.S. ±1-digit max.	—
Influence of temp. ^{※2}	Thermocouple	(PV ±0.5% or ±2°C, select the higher one) ±1-digit max. (TC input max. -100°C is within ±5°C)	
	RTD	• TC B, R, S, C, G, L, U: (PV ±0.5% or ±5°C, select the higher one) ±1-digit max.	
Control output	Relay	250VAC~ 3A, 30VDC= 3A, 1a	
	SSR	Max. 12VDC= ±3V 30mA	Max. 22VDC= ±3V 30mA
	Current	Selectable DC 4-20mA or DC 0-20mA (load resistance max. 500Ω)	—
Control method	Heating, Cooling Heating&Cooling	ON/OFF control, P, PI, PD, PID control	
Option output	Alarm	250VAC~ 3A 1a	—
	Communication	RS485 communication output (Modbus RTU method)	
Option input	CT input	0.0-50.0A (primary current measurement range) ※CT ratio=1/1000	—
	Digital input	• Contact input: ON max. 1kΩ, OFF min. 100kΩ • Solid-state input: ON residual voltage max. 1.5VDC=, OFF leakage current max. 0.1mA • Outflow current: Approx. 0.5mA per input	—
Hysteresis	1 to 100°C/°F (0.1 to 100°C/°F) variable		
Proportional band (P)	0.1 to 999.9°C/°F		
Integral time (I)	0 to 9999 sec		
Derivative time (D)	0 to 9999 sec		
Control period (T)	0.1 to 120.0 sec (only for relay output, SSR drive output)		
Manual reset	0.0 to 100.0%		
Relay life cycle	Mechanical	Min. 10,000,000 operations	
	Electrical	Min. 100,000 operations (250VAC 3A resistance load)	
Insulation resistance	Over 100MΩ (at 500VDC megger)		
Insulation type	Double insulation or reinforced insulation (mark:  , dielectric strength between the measuring input part and the power part: 1kV)		
Dielectric strength	1,000VAC 50/60Hz for 1 min (between input terminals and power terminals)		
Vibration	0.75mm amplitude at frequency of 5 to 55Hz (for 1 min) in each X, Y, Z direction for 2 hours		
Noise immunity	±0.5kV the square wave noise (pulse width: 1μs) by the noise simulator		
Environment	Ambient temp.	-10 to 50°C, storage: -20 to 60°C	
	Ambient humi.	35 to 85%RH, storage: 35 to 85%RH	
Accessories	Expansion connector: 1, Power/Comm. connector: 1 (only for basic module)		
Approval	   		
Weight ^{※3}	Basic module	Approx. 217g (approx. 152g)	Approx. 239g (approx. 174g)
	Expansion module	Approx. 208g (approx. 143g)	Approx. 231g (approx. 166g)

※1: In case of thermocouple K, J, E, T, N, it is below -100°C and L, U, Platinel II, it is below ±2°C ±1-digit.

In case of thermocouple B, display accuracy cannot be ensured under 400°C.

In case of thermocouple R, S, it is below 200°C and C, G, it is max. 3°C ±1-digit.

※2: Applied when it is for out of room temperature (23±5°C) range.

※3: The weight includes packaging. The weight in parentheses is for unit only.

※Environment resistance is rated at no freezing or condensation.

SENSORS

CONTROLLERS

MOTION DEVICES

SOFTWARE

(J) Temperature Controllers

(K) SSRs

(L) Power Controllers

(M) Counters

(N) Timers

(O) Digital Panel Meters

(P) Indicators

(Q) Converters

(R) Digital Display Units

(S) Sensor Controllers

(T) Switching Mode Power Supplies

(U) Recorders

(V) HMIs

(W) Panel PC

(X) Field Network Devices

TM Series

■ Dimensions

(unit: mm)

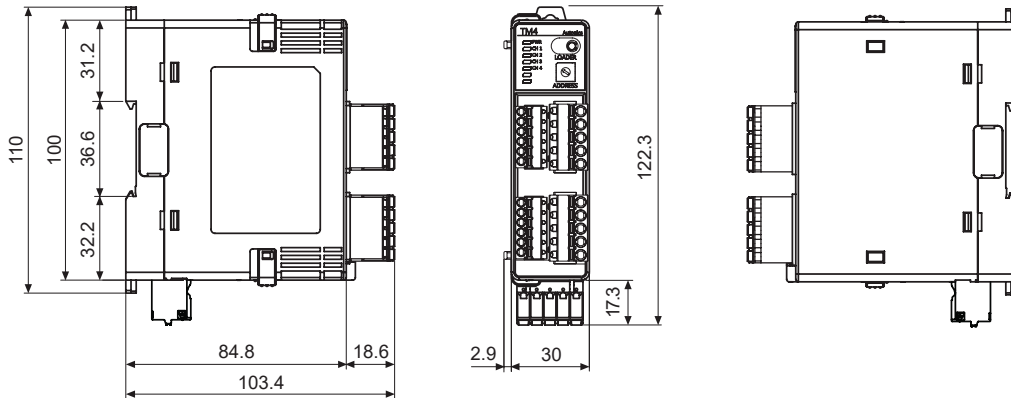

■ Unit Description

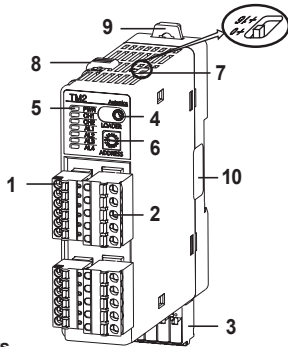

1. Sensor input connector
2. Control output connector
3. Power/Comm. terminal

[only for basic module (TM□□2□B)]

Supplying power to basic/expansion modules and communicating with over 1 module(s).

4. PC loader port

It is the PC loader port for serial communication between one module and PC to set parameter and monitoring by DAQMaster. Use this for connecting SCM-US (USB to serial converter, sold separately).

※When using PC loader port (connecting SCM-US), communication via power/comm. terminal is blocked and monitoring is not available.

5. Indicators ●TM2 Series

Indicator	Status	Initial power ON ^{※1}	Control output	Alarm output				Auto-tuning ^{※2}
				N.O. (Normally Open)		N.C. (Normally Closed)		
				OFF (OPEN)	ON (CLOSE)	OFF (CLOSE)	ON (OPEN)	
PWR (green) ^{※3}	ON	ON	—	—	—	—	ON	
CH1 (red)	Flash (2,400bps)	ON	—	—	—	—	Flash	
CH2 (red)	Flash (4,800bps)	ON	—	—	—	—	Flash	
AL1 (yellow)	Flash (9,600bps)	ON ^{※4}	OFF	ON	OFF	ON	OFF	
AL2 (yellow)	Flash (19,200bps)	ON ^{※5}	OFF	ON	OFF	ON	OFF	
AL3	Flash (38,400bps)	—	OFF	ON	OFF	ON	OFF	
AL4	—	—	OFF	ON	OFF	ON	OFF	

※1: When power is supplied initially, the set communication speed LED flashes for 5 sec.

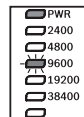

●TM4 Series

Indicator	Status	Initial power ON ^{※1}	Control output	Auto-tuning ^{※2}
PWR (green) ^{※3}	ON	ON	ON	ON
CH1 (red)	Flash (2,400bps)	ON	ON	Flash
CH2 (red)	Flash (4,800bps)	ON	ON	Flash
CH3 (red)	Flash (9,600bps)	ON	ON	Flash
CH4 (red)	Flash (19,200bps)	ON	ON	Flash
	Flash (38,400bps)	—	—	—

※2: The auto-tuning CH LED flashes for 1 sec in turn.

※3: The PWR LED flashes during communication for 1 sec in turn.

※4: Turns ON when CH1 control method is heating & cooling control and cooling output occurs. (disable AL1 setting)

※5: Turns ON when CH2 control method is heating & cooling control and cooling output occurs. (disable AL2 setting)

6. Communication address setting switch (SW1): Set the communication address.

7. Communication address group switch (SW2): When setting the communication address over 16, select +16.

8. Lock switch: Used for fixing modules at top and bottom.

9. Rail Lock: Used for installing at DIN rail or using bolts.

10. END cover: Remove it when connecting each module to connect an expansion connector.

2/4-CH Modular Type, PID Control

Connections and Block Diagram

TM2 Series

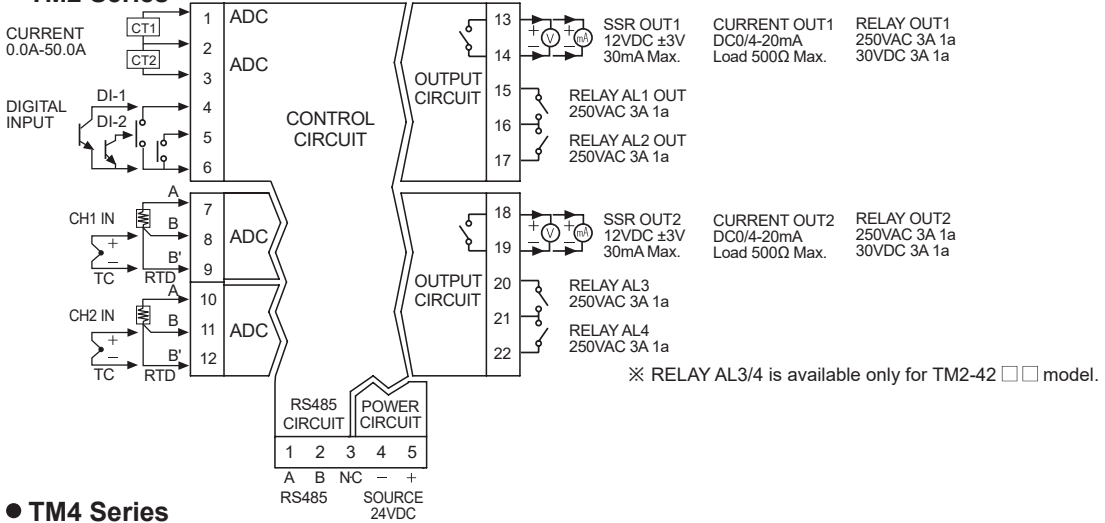

TM4 Series

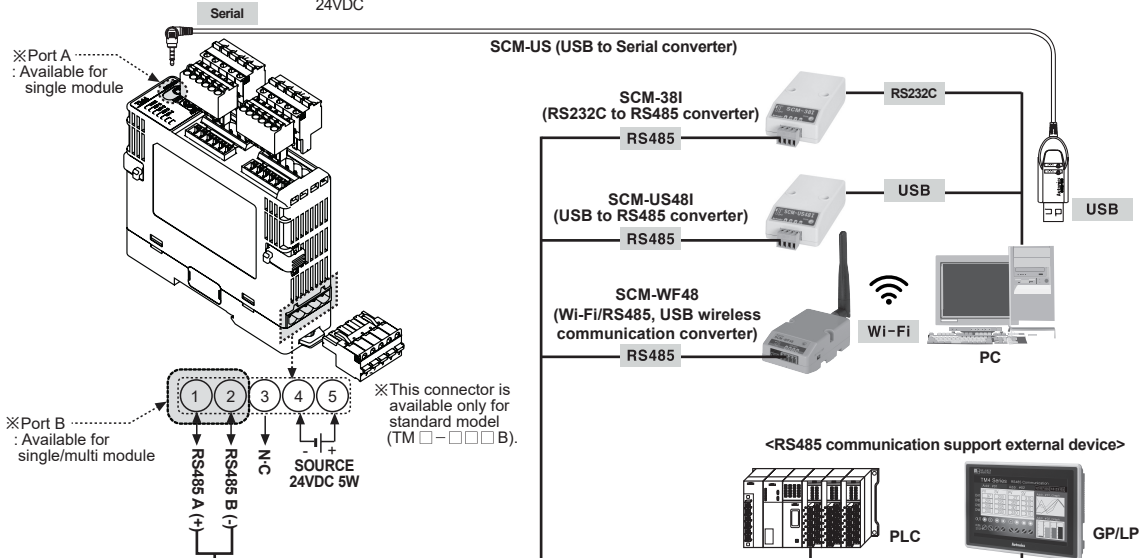
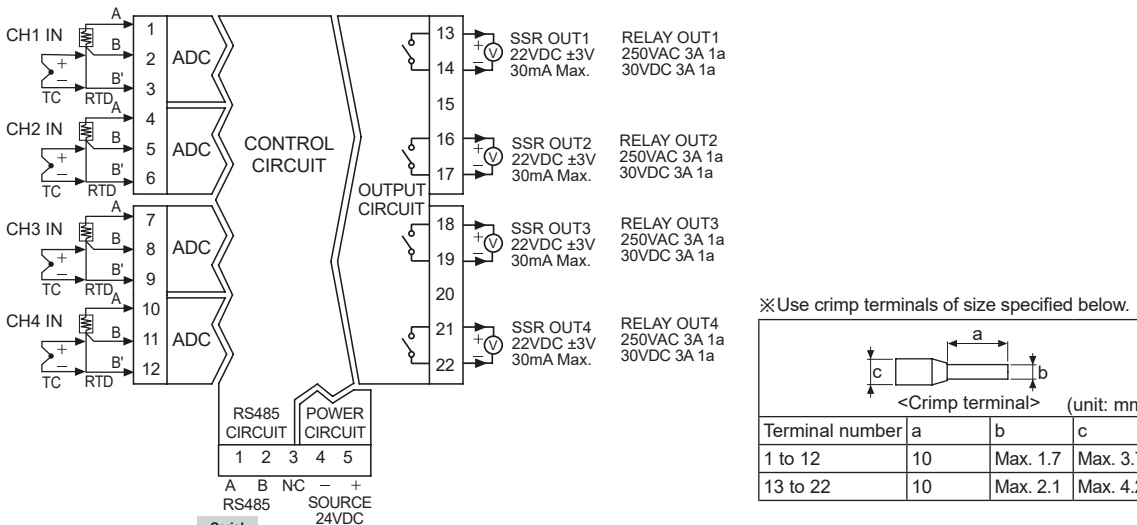

SENSORS
CONTROLLERS
MOTION DEVICES
SOFTWARE

(J) Temperature Controllers

(K) SSRs

(L) Power Controllers

(M) Counters

(N) Timers

(O) Digital Panel Meters

(P) Indicators

(Q) Converters

(R) Digital Display Units

(S) Sensor Controllers

(T) Switching Mode Power Supplies

(U) Recorders

(V) HMIs

(W) Panel PC

(X) Field Network Devices

TM Series

■ Installation

● Connector connection

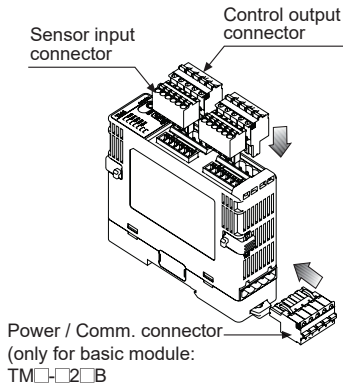

● Multi module connection

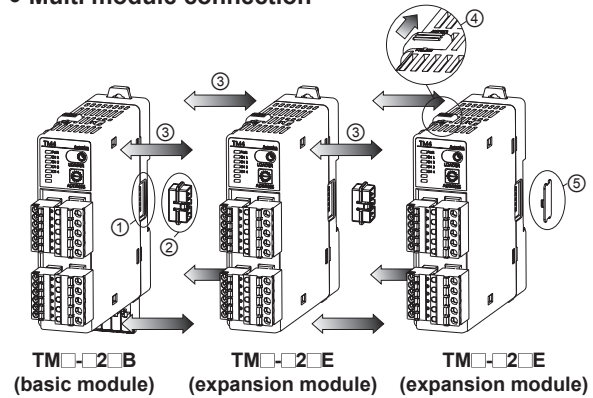

- ① Remove each module's END covers.
(do not remove at the ends of END covers)
 - ② Connect expansion connectors between modules.
 - ③ Push each modules. (max. 30 units)
 - ④ Push the lock switch to lock direction.
- ※ Supply adequate power for power input specifications and overall capacity.
(Max. power when connecting 31 modules:
31 units×5W=155W)

● Bolt inserting

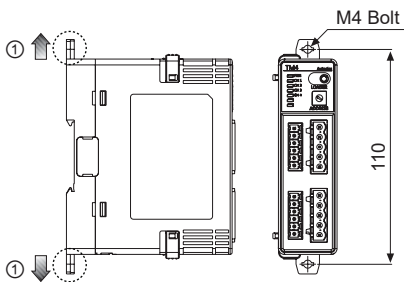

① Pull each Rail Lock switch up and down.

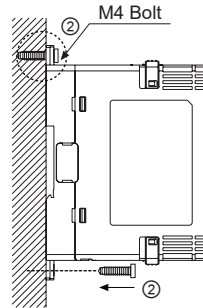

② Insert the bolts to fix.
(Tightening torque is 0.5N·m to 0.9N·m.)

● DIN rail Installation

[Installation method]

- ① Put the top edge of the rail Lock on the top edge or the DIN rail.
- ② Push the module body in while pressing down.

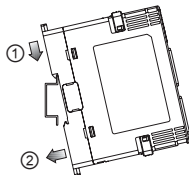

[Removal method]

- ① Press down the module body.
- ② Pull the module body forward.

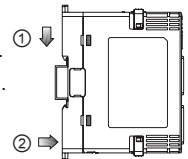

※ Install the units vertically.

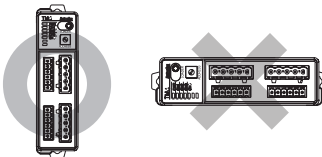

※ Use end plates (sold separately, not available from Autonics) to fix firmly.

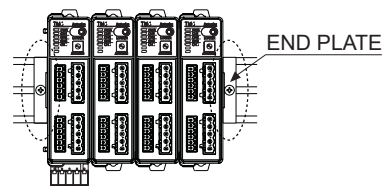

2/4-CH Modular Type, PID Control

Input Sensor Type and Temperature Range

Input sensor	No.	Dot	Display	Input range (°C)	Input range (°F)
Thermocouple	K(CA)	0	K(CA).H	-200 to 1350	-328 to 2462
		1	K(CA).L	-200.0 to 1350.0	-328.0 to 2462.0
	J(IC)	2	J(IC).H	-200 to 800	-328 to 1472
		3	J(IC).L	-200.0 to 800.0	-328.0 to 1472.0
	E(CR)	4	E(CR).H	-200 to 800	-328.0 to 1472
		5	E(CR).L	-200.0 to 800.0	-328.0 to 1472.0
	T(CC)	6	T(CC).H	-200 to 400	-328 to 752
		7	T(CC).L	-200.0 to 400.0	-328.0 to 752.0
	B(PR)	8	B(PR)	0 to 1800	32 to 3272
	R(PR)	9	R(PR)	0 to 1750	32 to 3182
	S(PR)	10	S(PR)	0 to 1750	32 to 3182
	N(NN)	11	N(NN)	-200 to 1300	-328 to 2372
	C(TT) ^{※1}	12	C(TT)	0 to 2300	32 to 4172
	G(TT) ^{※2}	13	G(TT)	0 to 2300	32 to 4172
	L(IC)	14	L(IC).H	-200 to 900	-328 to 1652
15		L(IC).L	-200.0 to 900.0	-328.0 to 1652.0	
U(CC)	16	U(CC).H	-200 to 400	-328 to 752	
	17	U(CC).L	-200.0 to 400.0	-328.0 to 752.0	
Platinel II	18	PLII	0 to 1400	32 to 2552	
RTD	JPt 100Ω	19	JPt100.H	-200 to 600	-328 to 1112
		20	JPt100.L	-200.0 to 600.0	-328.0 to 1112.0
	DPt 100Ω	21	DPt100.H	-200 to 600	-328 to 1112
		22	DPt100.L	-200.0 to 600.0	-328.0 to 1112.0

※1: C(TT): Same as existing W5(TT).

※2: G(TT): Same as existing W(TT).

※Default: K(CA).H

Error Display

Indicators	Status	
	Disconnected input sensors	Out of temperature range
PWR (red)	ON	
CH□ (red) ^{※1}	Flash (for 0.5 sec in turn)	
Comm. output (decimal)	Outputs '31000'	Outputs '30000 (high-limit)', '-30000 (low-limit)'
DAQMaster	Displays 'OPEN'	Displays 'HHHH (high-limit)', 'LLLL (low-limit)'

※1: The applied CH LED indicator flashes.

SENSORS

CONTROLLERS

MOTION DEVICES

SOFTWARE

(J)
Temperature
Controllers

(K)
SSRs

(L)
Power
Controllers

(M)
Counters

(N)
Timers

(O)
Digital
Panel Meters

(P)
Indicators

(Q)
Converters

(R)
Digital
Display Units

(S)
Sensor
Controllers

(T)
Switching
Mode Power
Supplies

(U)
Recorders

(V)
HMIs

(W)
Panel PC

(X)
Field Network
Devices

■ Communication Setting

It is for parameter setting and monitoring via external devices (PC, PLC, etc.).

• Interface

Comm. protocol	Modbus RTU	Comm. distance	Max. 800m
Connection type	RS485	Comm. speed	2400, 4800, 9600 (default), 19200, 38400 bps
Application standard	Compliance with EIA RS485	Start bit	1-bit (fixed)
Max. connection	31 units (address: 01 to 31)	Data bit	8-bit (fixed)
Synchronous method	Asynchronous	Parity bit	None (default), Odd, Even
Comm. method	Two-wire half duplex	Stop bit	1-bit, 2-bit (default)

※It is not allowed to set overlapping communication address at the same communication line.
Use twisted pair wire for RS485 communication.

• Application of system organization

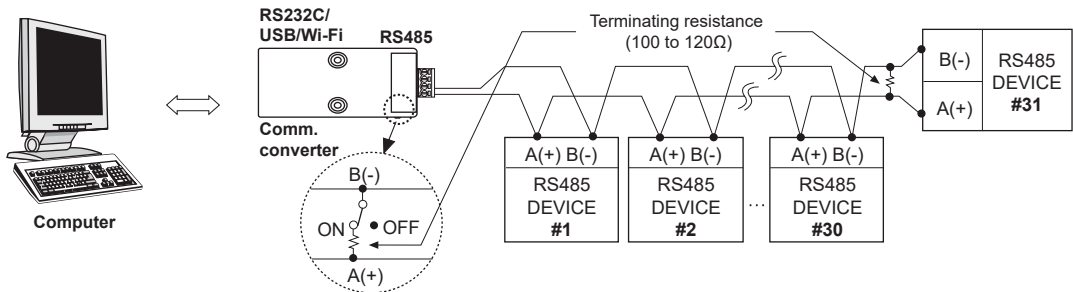

※It is recommended to use Autonics communication converter; SCM-WF48 (Wi-Fi to RS485-USB wireless communication converter, sold separately), SCM-US48I (USB to RS485 converter, sold separately), SCM-38I (RS232C to RS485 converter, sold separately).

Please use twisted pair wire, which is suitable for RS485 communication, for SCM-WF48, SCM-US48I and SCM-38I.

• Communication Address Setting

Set the communication address by the communication address setting switch (SW1) and Communication address group switch (SW2).
When setting as 0, it does not operate communication.

(setting range: 01 to 31, factory default: [SW1] 1, [SW2] +0)

SW2 \ SW1		SW1															
		0	1	2	3	4	5	6	7	8	9	A	B	C	D	E	F
+0	+16	00	01	02	03	04	05	06	07	08	09	10	11	12	13	14	15
	+0	16	17	18	19	20	21	22	23	24	25	26	27	28	29	30	31

• Caution for Communication Address Setting

When changing communication address via the Power/Comm. terminal, resupply the power.

■ Sold Separately

◎ Communication converter

• SCM-WF48

(Wi-Fi to RS485-USB wireless communication converter)



• SCM-US48I

(USB to RS485 converter)



• SCM-38I

(RS232C to RS485 converter)



• SCM-US

(USB to Serial converter)



2/4-CH Modular Type, PID Control

■ Sold Separately

◎ Current transformer (CT)

● CSTC-E80LN

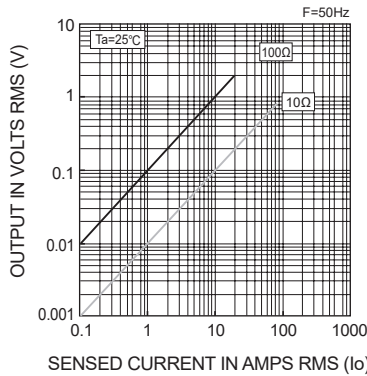
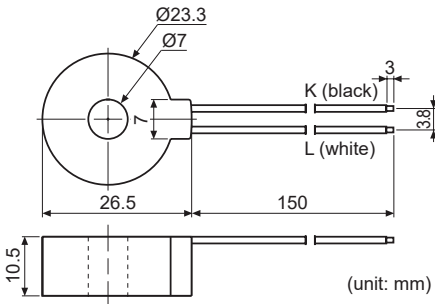

- Max. load current: 80A (50/60Hz)
※Max. load current for TM Series is 50A.
- Current ratio: 1/1000
- Wire wounded resistance: $31\Omega \pm 10\%$

● CSTC-E200LN

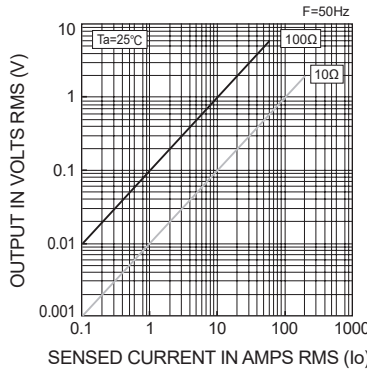
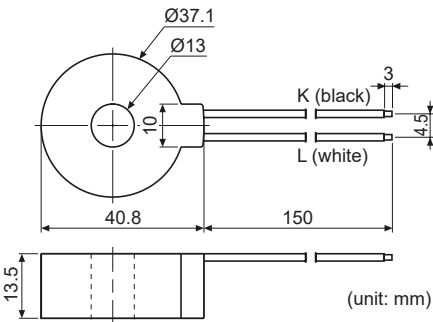

- Max. load current: 200A (50/60Hz)
※Max. load current for TM Series is 50A.
- Current ratio: 1/1000
- Wire wounded resistance: $20\Omega \pm 10\%$

● CSTS-E80PP

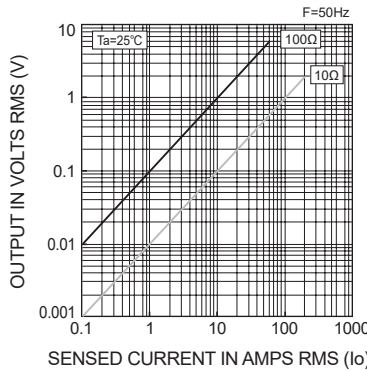
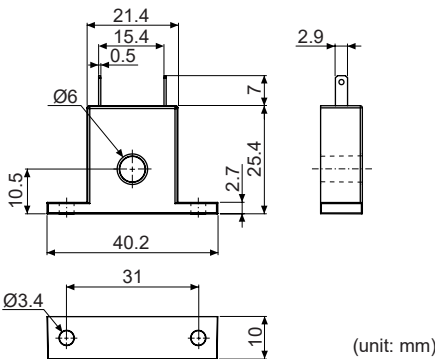

- Max. load current: 80A (50/60Hz)
※Max. load current for TM Series is 50A.
- Current ratio: 1/1000
- Wire wounded resistance $31\Omega \pm 10\%$

※Do not supply primary current in case that CT output is open. High voltage will be generated in CT output.
 ※The current for above CTs is 50A same but inner hole sizes are different. Please use this for your environment.

◎ Display units (DS/DA-T Series)

● DS/DA-T Series

(RS485 communication input type display unit) C E



DS16-CT



DS22/DA22-CT



DS40/DA40-CT



DS60/DA60-CT

※Connect RS485 communication input type display unit (DS/DA-T Series) and TM Series, the display unit displays present value of the device without PC/PLC.

SENSORS

CONTROLLERS

MOTION DEVICES

SOFTWARE

(J) Temperature Controllers

(K) SSRs

(L) Power Controllers

(M) Counters

(N) Timers

(O) Digital Panel Meters

(P) Indicators

(Q) Converters

(R) Digital Display Units

(S) Sensor Controllers

(T) Switching Mode Power Supplies

(U) Recorders

(V) HMIs

(W) Panel PC

(X) Field Network Devices

■ Proper Usage

◎ Simple failure diagnosis

- **LED indicators flash (for 0.5 sec in turn), or external device displays OPEN.**
 - Check input sensor setting.
 - Disconnect the power and check the input connection.
 - If input is connected, disconnect the input wiring from the temperature controller and short the + and - terminals. Power the temperature controller and check if the external device displays the room temperature. If it does not display the room temperature and continues to display HHHH or LLLL, the controller is broken. Please contact our technical support. (input type is thermocouple)
- **Output does not operate normally.**
 - Check that CH indicators for control output operates normally.
 - If CH indicators for control output does not operates, check the parameter settings.
 - If CH indicators for control output operates, remove the control output connector and check the output.
- **External device receives no-response or abnormal data.**
 - Check the communication converter (SCM-WF48 or SCM-US48I, SCM-38I, SCM-US, sold separately).
 - Do not install communication converter line and AC power supply lines.
 - Use different communication converter power and temperature controller power.
 - Indicates damage to internal chip by strong noise. Please contact our technical support. Locate the source of the noise device countermeasures.
- **Communication does not work between TM and external device**
 - Check the communication converter power and connections.
 - Check the communication settings.
 - Check the temperature controller and external device connections.

◎ Cautions during use

- Follow instructions in 'Cautions during Use'. Otherwise, It may cause unexpected accidents.
- Check the polarity of the terminals before wiring the temperature sensor.
For RTD temperature sensor, wire it as 3-wire type, using cables in same thickness and length.
For thermocouple (CT) temperature sensor, use the designated compensation wire for extending wire.
- Keep away from high voltage lines or power lines to prevent inductive noise.
In case installing power line and input signal line closely, use line filter or varistor at power line and shielded wire at input signal line.
Do not use near the equipment which generates strong magnetic force or high frequency noise.
- Do not apply excessive power when connecting or disconnecting the connectors of the product.
- Install a power switch or circuit breaker in the easily accessible place for supplying or disconnecting the power.
- Do not use the unit for other purpose (e.g. voltmeter, ammeter), but temperature controller.
- When changing the input sensor, turn off the power first before changing.
After changing the input sensor, modify the value of the corresponding parameter.
- 24VDC power supply should be insulated and limited voltage/current or Class 2, SELV power supply device.
- Do not overlapping communication line and power line. Use twisted pair wire for communication line and connect ferrite bead at each end of line to reduce the effect of external noise.
- Make a required space around the unit for radiation of heat.
For accurate temperature measurement, warm up the unit over 20 min after turning on the power.
- Make sure that power supply voltage reaches to the rated voltage within 2 sec after supplying power.
- Do not wire to terminals which are not used.
- Install DIN rail vertically from the ground.
- This unit may be used in the following environments.
 - ① Indoors (in the environment condition rated in 'Specifications')
 - ② Altitude max. 2,000m
 - ③ Pollution degree 2
 - ④ Installation category II