

## Advance Information

MMM5063/D  
Rev. 0.2, 09/2003

Tri-Band GSM GPRS  
3.5 V Power Amplifier



# MMM5063

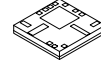

(Scale 1:1)

### Package Information

Plastic Package  
Case 1383  
(Module, 7x7 mm)

### Ordering Information

Device	Device Marking	Package
MMM5063	See Figure 25	Module

The MMM5063 is a tri-band single supply RF Power Amplifier for GSM900/DCS1800/PCS1900 GPRS handheld radios. This fully integrated Power Amplifier uses a patented concept to realize the 50  $\Omega$  matching on-chip through integration of passives on the GaAs die. This allows module functionality in a very small 7 x 7 mm package and achieves best-in-class Power Amplifier performance and multi-band capability.

### Applications:

- Tri-Band GSM900 DCS1800 and PCS1900
- Guaranteed for 25% Duty Cycle

### Features:

- Single Supply Enhancement Mode GaAs MESFET Technology
- Internal 50  $\Omega$  Input/Output Matching
- High Gain Three Stage Amplifier Design
- Typical 3.5 V Characteristics:
  - $P_{out} = 35.2$  dBm, PAE = 53% for GSM
  - $P_{out} = 33.8$  dBm, PAE = 44% for DCS
  - $P_{out} = 34$  dBm, PAE = 43% for PCS
- Optimized and Guaranteed for Open-Loop Power Control Applications
- Small 7 x 7 mm Package

## Electrical Specifications

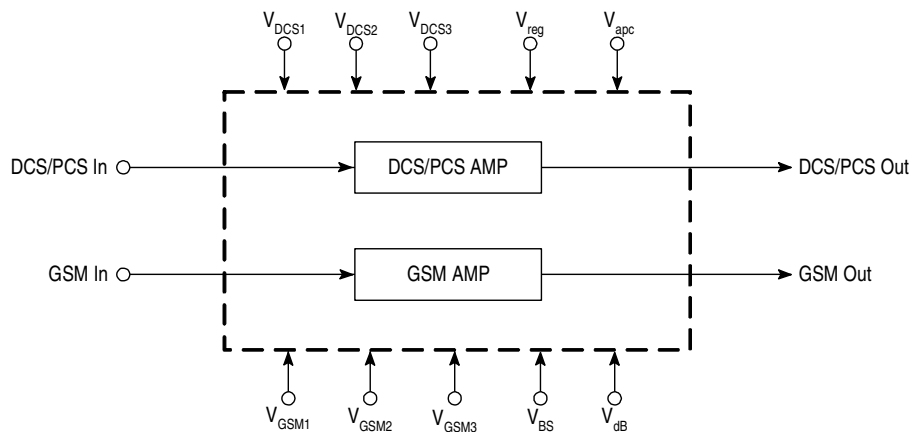

This device contains 26 active transistors.

**Figure 1. Simplified Block Diagram**

## 1 Electrical Specifications

**Table 1. Maximum Ratings**

Rating	Symbol	Value	Unit
Supply Voltage	$V_{GSM1,2,3}$ $V_{DCS1,2,3}$ , $V_{dB}$	6.0	V
RF Input Power	GSM IN, DCS/PCS IN	11	dBm
RF Output Power GSM Section DCS/PCS Section	GSM OUT DCS/PCS OUT	38 36	dBm
Operating Case Temperature Range	$T_C$	-35 to 100	°C
Storage Temperature Range	$T_{stg}$	-55 to 150	°C
Die Temperature	$T_J$	150	°C

- NOTES:** 1. Maximum Ratings are those values beyond which damage to the device may occur. Functional operation should be restricted to the limits in the Electrical Characteristics or Recommended Operating Conditions tables.  
 2. ESD (electrostatic discharge) immunity meets Human Body Model (HBM)  $\leq 150$  V and Machine Model (MM)  $\leq 50$  V. Additional ESD data available upon request.  
 3. Meets Moisture Sensitivity Level (MSL) 3. See Figure 25 on page 17 for additional details.

**Table 2. Recommended Operating Conditions**

Characteristic	Symbol	Min	Typ	Max	Unit
Drain Supply Voltage	$V_{GSM1,2,3}$ , $V_{DCS1,2,3}$	2.7	-	5.5	V
Bias Supply Voltage	$V_{dB}$	2.7	-	5.5	V
Regulated Voltage	$V_{REG}$	2.5	2.8	3.0	V
Power Control Voltage	$V_{apc}$	0	1.8	2.8	V
Band Select	$V_{BS}$	0	2.8	3.0	V
Input Power GSM	GSM IN	-1.0	-	8.0	dBm
Input Power DCS/PCS	DCS/PCS IN	2.0	-	10	dBm

**Table 3. Control Requirements**

Characteristic	Symbol	Min	Typ	Max	Unit
Current for $V_{reg}$ @ 2.8 V	$I_{reg}$	-	7.7	10	mA
Band Select Low Band Enable Voltage High Band Enable Voltage	$V_{BS}$	2.2 0	2.8 -	- 0.3	V
Current for $V_{BS} = 2.8$ V	$I_{BS}$	-	0.76	1.0	mA

**Table 4. Electrical Characteristics**

(Peak measurement at 25% duty cycle, 4.6 ms period,  $T_A = 25^\circ\text{C}$ , unless otherwise noted.)

Characteristic	Symbol	Min	Typ	Max	Unit
<b>GSM 900 Section</b> ( $P_{in} = -1.0$ dBm, $V_{GSM1,2,3} = 3.5$ V pulsed, $V_{dB} = 3.5$ V, $V_{REG} = V_{BS} = 2.8$ V, $V_{ramp} = 1.8$ V pulsed)					
Frequency Range	BW	880	-	915	MHz
Output Power	$P_{out}$	34.2	35.2	-	dBm
Power Added Efficiency	PAE	48	53	-	%
Output Power @ Low Voltage ( $V_{GSM1,2,3} = 2.8$ V pulsed, $V_{dB} = 2.8$ V)	$P_{out}$	32.5	33.4	-	dBm
Power Added Efficiency @ Low Voltage ( $V_{GSM1,2,3} = 2.8$ V pulsed, $V_{dB} = 2.8$ V)	PAE	48	54	-	%
Harmonic Output					dBc
$2f_o$		-	-37	-33	
$\geq 3f_o$		-	-60	-45	

## Electrical Specifications

**Table 4. Electrical Characteristics (Continued)**

(Peak measurement at 25% duty cycle, 4.6 ms period,  $T_A = 25^\circ\text{C}$ , unless otherwise noted.)

Characteristic	Symbol	Min	Typ	Max	Unit
Second Harmonic Leakage at DCS Output (Crosstalk isolation)		-	-28	-15	dBm
Input Return Loss	$ S_{11} $	-	10	-	dB
Output Power Isolation ( $V_{\text{ramp}} = 0\text{ V}$ , $V_{\text{GSM1,2,3}} = 0\text{ V}$ )	$P_{\text{off}}$	-	-45	-40	dBm
Noise Power in Rx Band @ $P_{\text{in}} = -1.0\text{ dBm}$ (100 kHz measurement bandwidth) @ $f_o + 10\text{ MHz}$ ( $f_o = 915\text{ MHz}$ ) @ $f_o + 20\text{ MHz}$ ( $f_o = 915\text{ MHz}$ )	NP	-	-80 -81	-	dBm
Noise Power in Rx Band @ $P_{\text{in}} = 6.0\text{ dBm}$ (100 kHz measurement bandwidth) @ $f_o + 10\text{ MHz}$ ( $f_o = 915\text{ MHz}$ ) @ $f_o + 20\text{ MHz}$ ( $f_o = 915\text{ MHz}$ )	NP	-	-84 -86	-77 -81	dBm
Stability-Spurious Output ( $P_{\text{out}} = 5.0\text{ to }35\text{ dBm}$ , Load VSWR = 6:1 all Phase Angles, Adjust $V_{\text{ramp}}$ for specified power)	$P_{\text{spur}}$	-	-	-60	dBc
Load Mismatch Stress ( $P_{\text{out}} = 5.0\text{ to }35\text{ dBm}$ , Load VSWR = 10:1 all phase angles, 5 seconds, Adjust $V_{\text{ramp}}$ for specified power)		No Degradation in Output Power Before and After Test			

**DCS Section** ( $P_{\text{in}} = 2.0\text{ dBm}$ ,  $V_{\text{DCS1,2,3}} = 3.5\text{ V}$  pulsed,  $V_{\text{dB}} = 3.5\text{ V}$ ,  $V_{\text{REG}} = 2.8\text{ V}$ ,  $V_{\text{ramp}} = 1.8\text{ V}$  pulsed,  $V_{\text{BS}} = 0\text{ V}$ )

Frequency Range	BW	1710	-	1785	MHz
Output Power	$P_{\text{out}}$	32.5	33.8	-	dBm
Power Added Efficiency	PAE	38	44	-	%
Output Power @ Low Voltage ( $V_{\text{DCS1,2,3}} = 2.8\text{ V}$ pulsed, $V_{\text{dB}} = 2.8\text{ V}$ )	$P_{\text{out}}$	31	32	-	dBm
Power Added Efficiency @ Low Voltage ( $V_{\text{DCS1,2,3}} = 2.8\text{ V}$ pulsed, $V_{\text{dB}} = 2.8\text{ V}$ )	PAE	38	45	-	%
Harmonic Output $2f_o$ $\geq 3f_o$		-	-65 -50	-45 -45	dBc
Input Return Loss	$ S_{11} $	-	9.0	-	dB
Output Power Isolation ( $V_{\text{ramp}} = 0\text{ V}$ , $V_{\text{DCS1,2,3}} = 0\text{ V}$ )	$P_{\text{off}}$	-	-40	-35	dBm
Noise Power in Rx Band @ $P_{\text{in}} = 2.0\text{ dBm}$ @ $f_o + 20\text{ MHz}$ ( $f_o = 1785\text{ MHz}$ ) (100 kHz measurement bandwidth)	NP	-	-78	-75	dBm
Stability-Spurious Output ( $P_{\text{out}} = 0\text{ to }33\text{ dBm}$ , Load VSWR = 6:1 all Phase Angles, Adjust $V_{\text{ramp}}$ for specified power)	$P_{\text{spur}}$	-	-	-60	dBc

**Table 4. Electrical Characteristics (Continued)**

(Peak measurement at 25% duty cycle, 4.6 ms period,  $T_A = 25^\circ\text{C}$ , unless otherwise noted.)

Characteristic	Symbol	Min	Typ	Max	Unit
Load Mismatch Stress ( $P_{out} = 0$ to 33 dBm, Load VSWR = 10:1 all phase angles, 5 seconds, Adjust $V_{ramp}$ for specified power)		No Degradation in Output Power Before and After Test			
<b>PCS Section</b> ( $P_{in} = 3.0$ dBm, $V_{DCS1,2,3} = 3.5$ V pulsed, $V_{dB} = 3.5$ V, $V_{REG} = 2.8$ V, $V_{ramp} = 1.8$ V pulsed, $V_{BS} = 0$ V)					
Frequency Range	BW	1850	-	1910	MHz
Output Power	$P_{out}$	32.5	34	-	dBm
Power Added Efficiency	PAE	37	43	-	%
Output Power @ Low Voltage ( $V_{DCS1,2,3} = 2.8$ V pulsed, $V_{dB} = 2.8$ V)	$P_{out}$	31	32	-	dBm
Power Added Efficiency @ Low Voltage ( $V_{DCS1,2,3} = 2.8$ V pulsed, $V_{dB} = 2.8$ V)	PAE	37	43	-	%
Harmonic Output $2f_o$ $\geq 3f_o$		- -	-65 -50	-45 -45	dBc
Input Return Loss	$ S_{11} $	-	5.0	-	dB
Output Power Isolation ( $V_{ramp} = 0$ V, $V_{DCS1,2,3} = 0$ V)	$P_{off}$	-	-35	-32	dBm
Noise Power in Rx Band @ $P_{in} = 3.0$ dBm @ $f_o + 20$ MHz ( $f_o = 1910$ MHz) (100 kHz measurement bandwidth)	NP	-	-78	-75	dBm
Stability-Spurious Output ( $P_{out} = 0$ to 33 dBm, Load VSWR = 6:1 all Phase Angles, Adjust $V_{ramp}$ for specified power)	$P_{spur}$	-	-	-60	dBc
Load Mismatch Stress ( $P_{out} = 0$ to 33 dBm, Load VSWR = 10:1 all phase angles, 5 seconds, Adjust $V_{ramp}$ for specified power)		No Degradation in Output Power Before and After Test			

## 2 Typical Performance Characteristics

### 2.1 GSM

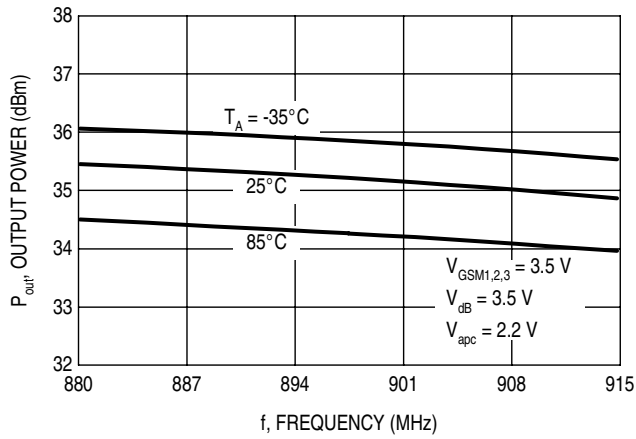

Figure 2. Output Power versus Frequency

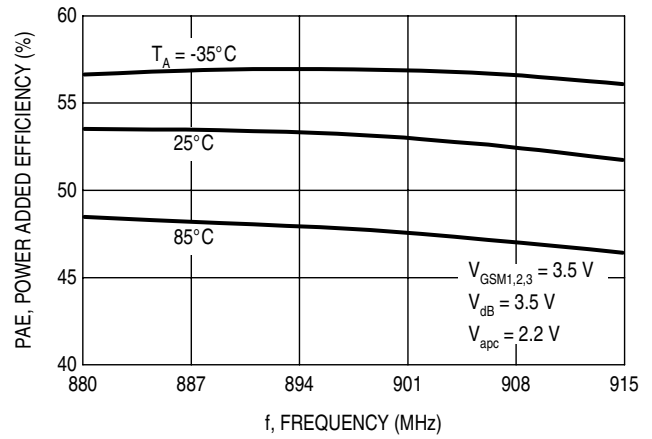

Figure 3. Power Added Efficiency versus Frequency

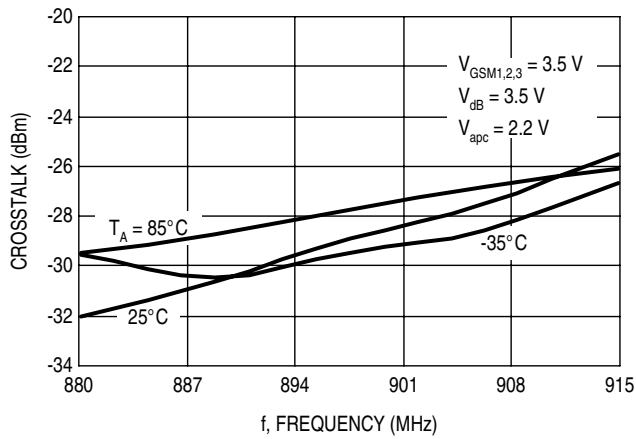

Figure 4. Crosstalk versus Frequency

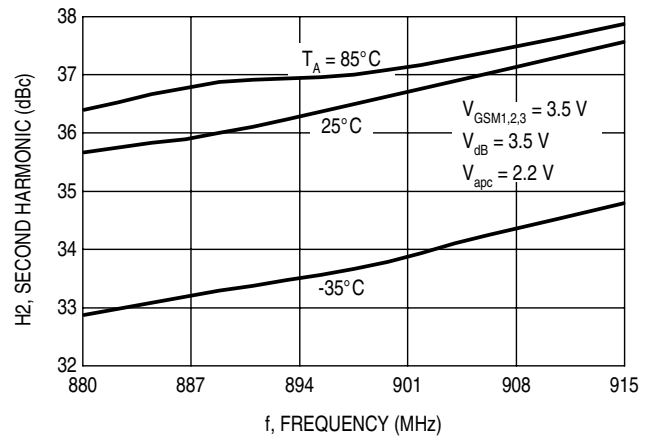

Figure 5. Second Harmonic Output versus Frequency

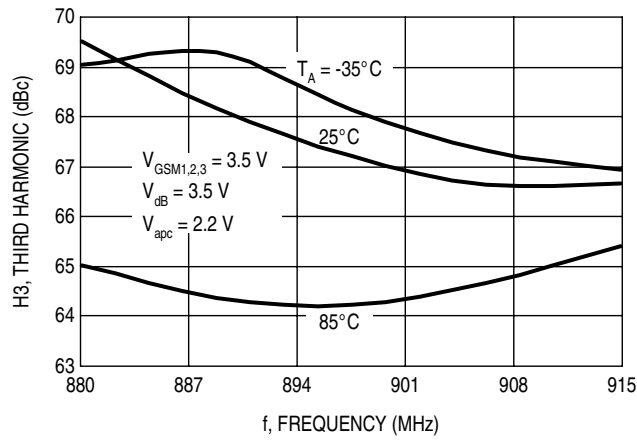

Figure 6. Third Harmonic Output versus Frequency

## 2.2 DCS

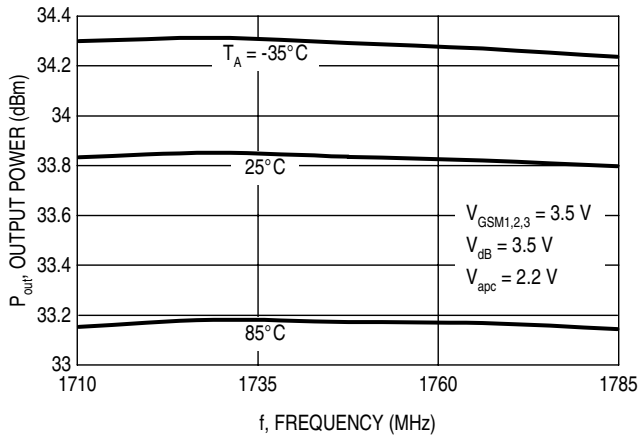

Figure 7. Output Power versus Frequency

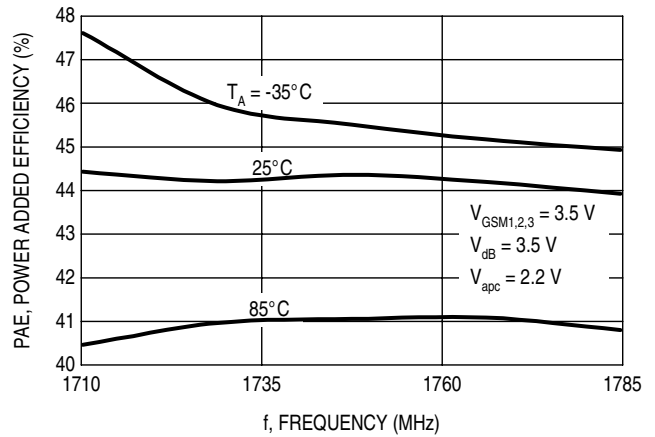

Figure 8. Power Added Efficiency versus Frequency

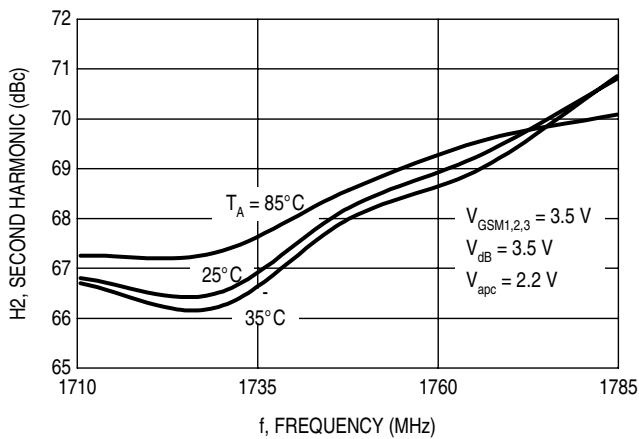

Figure 9. Second Harmonic Output versus Frequency

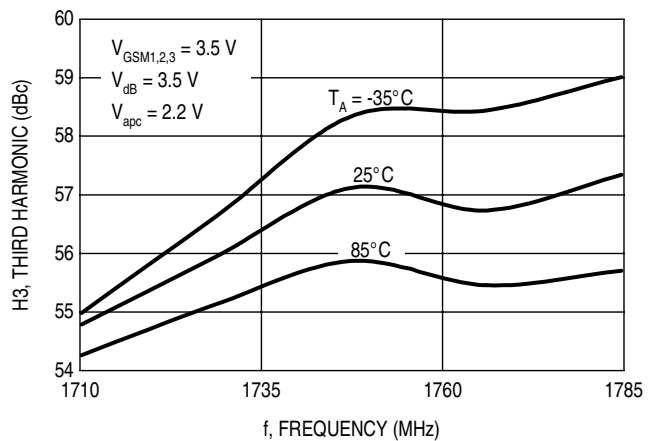
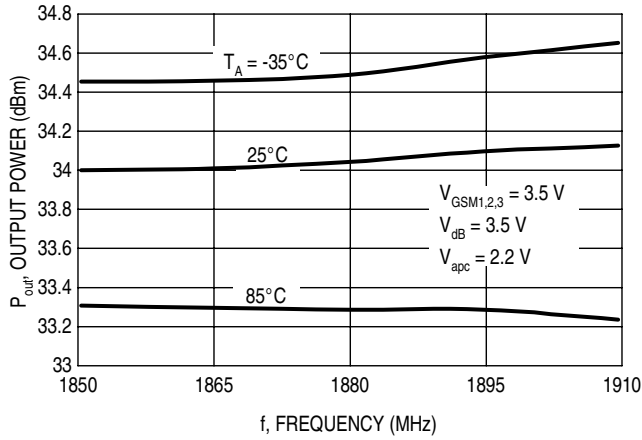

Figure 10. Third Harmonic Output versus Frequency

# Typical Performance Characteristics

## 2.3 PCS



**Figure 11. Output Power versus Frequency**

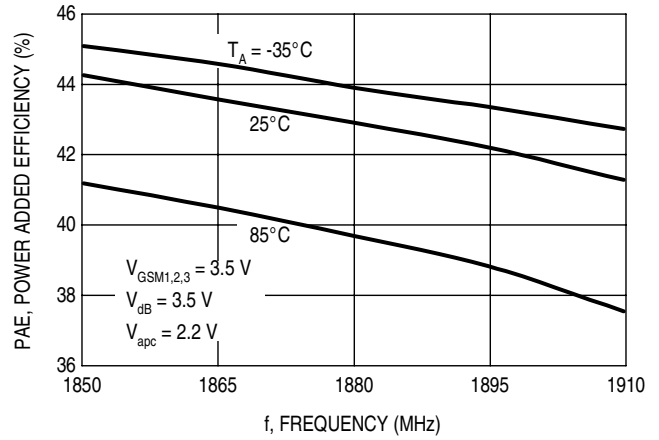

**Figure 12. Power Added Efficiency versus Frequency**

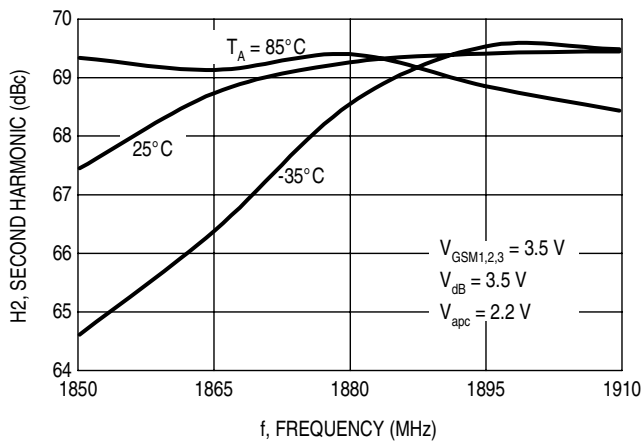

**Figure 13. Second Harmonic Output versus Frequency**

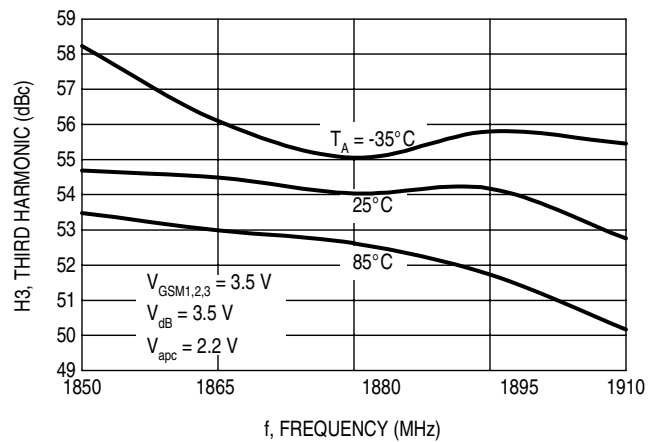

**Figure 14. Third Harmonic Output versus Frequency**



### 3 Contact Descriptions and Connections

Table 5. Contact Function Description

Pin	Symbol	Description
1	$V_{reg}$	Regulated dc voltage for bias circuit
2	$V_{dB}$	DC supply voltage for active bias circuits connected to the battery
3	DCS/PCS Out	DCS/PCS RF output
4	$V_{DCS3}$	DCS/PCS DC supply voltage for 3rd stage
5	$V_{DCS2}$	DCS/PCS DC supply voltage for 2nd stage
6	$V_{DCS1}$	DCS/PCS DC supply voltage for 1st stage
7	$V_{apc}$	Power control for both line-ups ( $V_{apc} = 0\text{ V}$ , $P_{out} = P_{off}$ , $V_{apc} = 1.8\text{ V}$ , $P_{out} = P_{max}$ )
8	DCS/PCS In	DCS/PCS RF input
9	GSM In	GSM RF input
10	$V_{GSM1}$	GSM DC supply voltage for 1st stage
11	$V_{GSM2}$	GSM DC supply voltage for 2nd stage
12	$V_{GSM3}$	GSM DC supply voltage for 3rd stage
13	GSM Out	GSM RF output
14	$V_{BS}$	Band selection between GSM and DCS/PCS

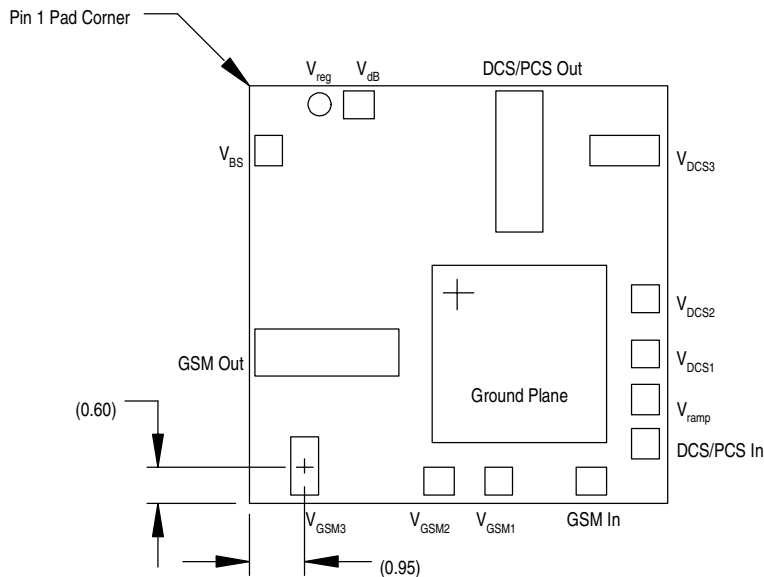

**NOTE:** For optimum performance  $V_{GSM1}$  and  $V_{GSM2}$ , as well as  $V_{DCS1}$  and  $V_{DCS2}$ , must be strapped together on the application demobard.

Figure 15. Contact Connections  
(Bottom View)

## 4 Application Information

### 4.1 Power Control Considerations

The MMM5063 is designed for open loop (drain control) applications. A PMOS FET is used to switch the MMM5063 drain and vary the supply voltage from 0 to the battery voltage setting ( $V_{bat}$ ). The simplified concept schematic (see Figure 22) describes the application circuit used to control the device through the drain voltage.

A drain control provides a linear transfer function which is repeatable versus control voltage (see Figure 16).

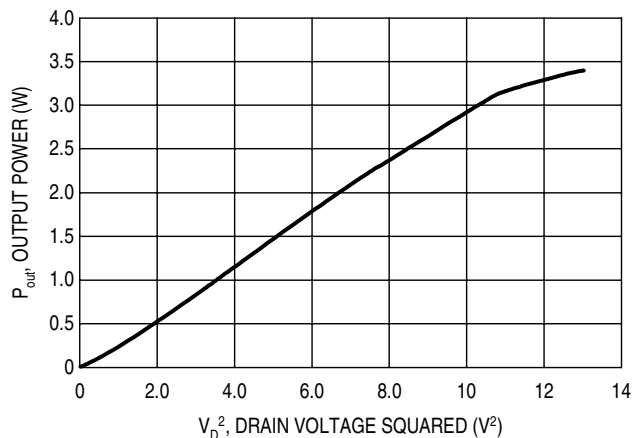

Figure 16. Output Power versus Drain Voltage

### 4.2 GSM Second Harmonic (H2) Trap Circuitry

When transmitting in GSM saturated mode, the second harmonic is naturally present at the RF output of the PA and reaches the antenna after additional filtering in the front-end. ETSI specifies that harmonic level cannot exceed -36 dBm. In order to improve H2 rejection in low Band (GSM), an H2 trap has been developed. The topology is based on a Low Pass  $\pi$  Cell Filter (see Figure 17) where the first shunt capacitor is actually part of the PA output match.

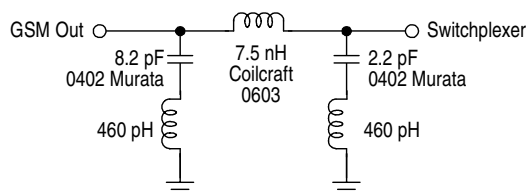

Figure 17. Low Pass Filter

This circuit reduces H2 level by 7 to 8 dB with low in-band insertion losses (mainly due to the series inductor). Moreover, this structure can be used to match Power amplifier module output to the switchplexer.



## Application Information

R8 and  $R_{V_{apc}}$  set  $V_{apc}$  at 0.9 V while R7 sets the  $V_{apc}$  slope.  $V_{apc}$  versus  $V_{drain}$  is shown in the Figure 20.

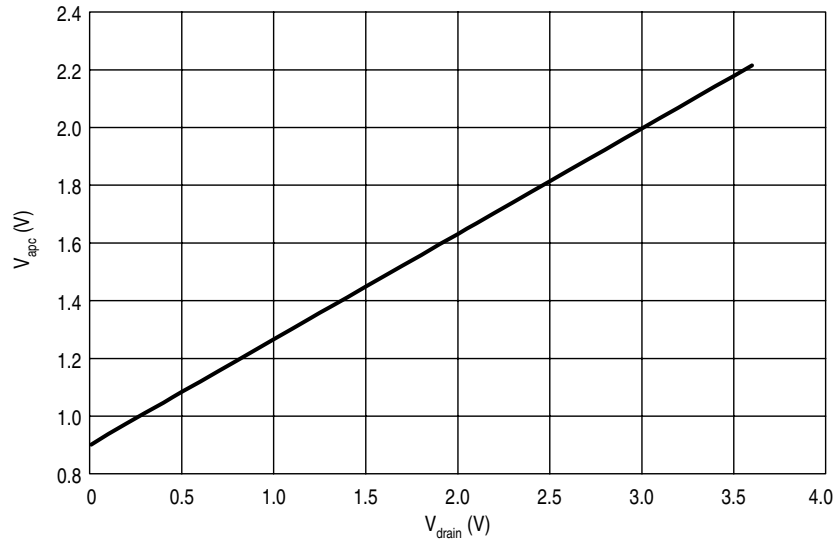

**Figure 20.  $V_{apc}$  versus  $V_{drain}$**

It is possible that the Power Control DAC output voltage can be in the 200 mV to 2.0 V range. This raises a concern for the MMM5063 ramp control voltage ( $V_{ramp}$ ) which must start at 0 V to get enough output power dynamic range. To overcome this limitation, a resistor (R6 in Figure 22) is used to set an additional offset (200 mV with  $R6 = 39 \text{ k}\Omega$ ). This residual voltage is then subtracted the DAC output voltage through the differential Operational Amplifier.

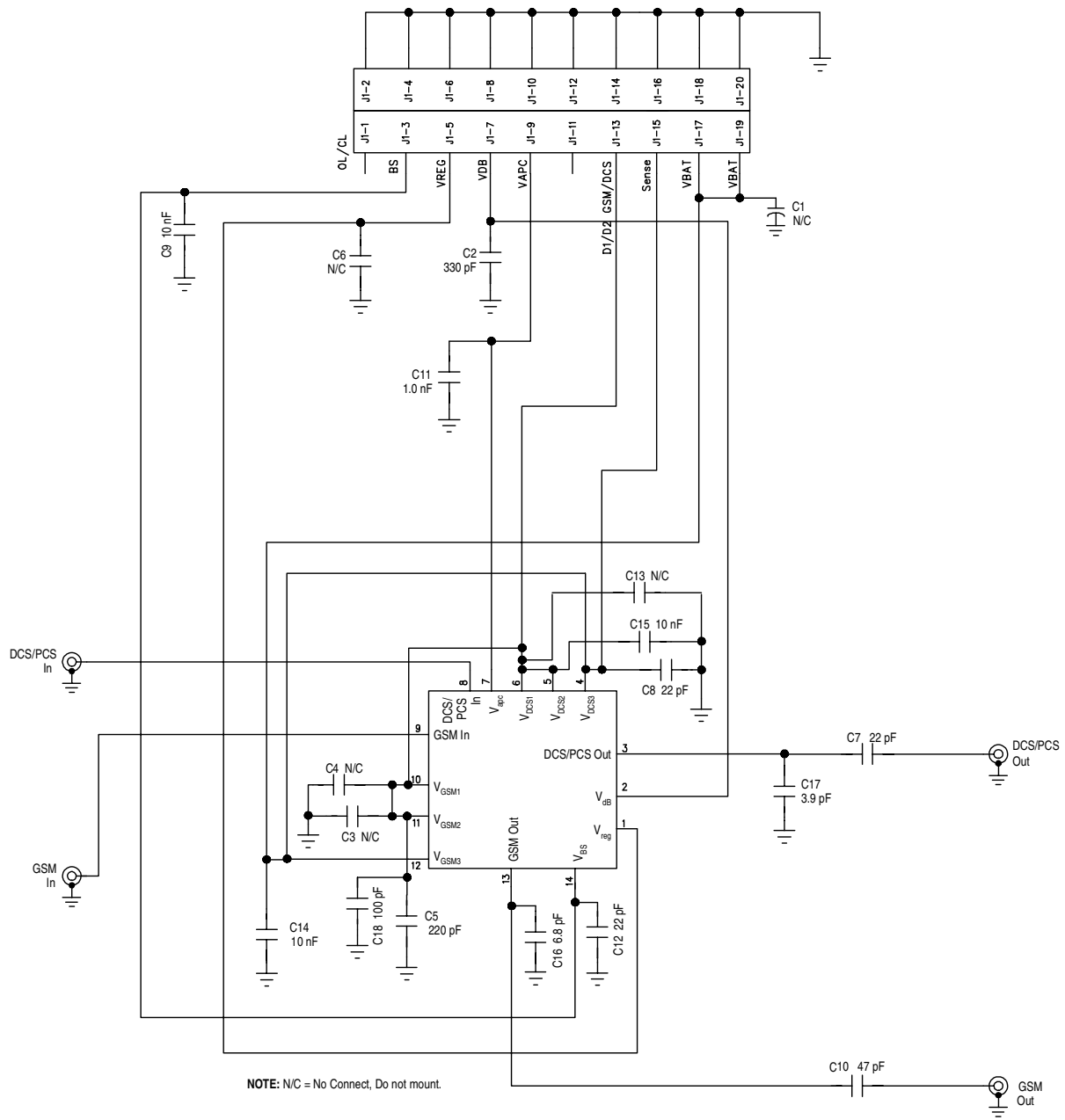

Figure 21. PA Evaluation Circuit

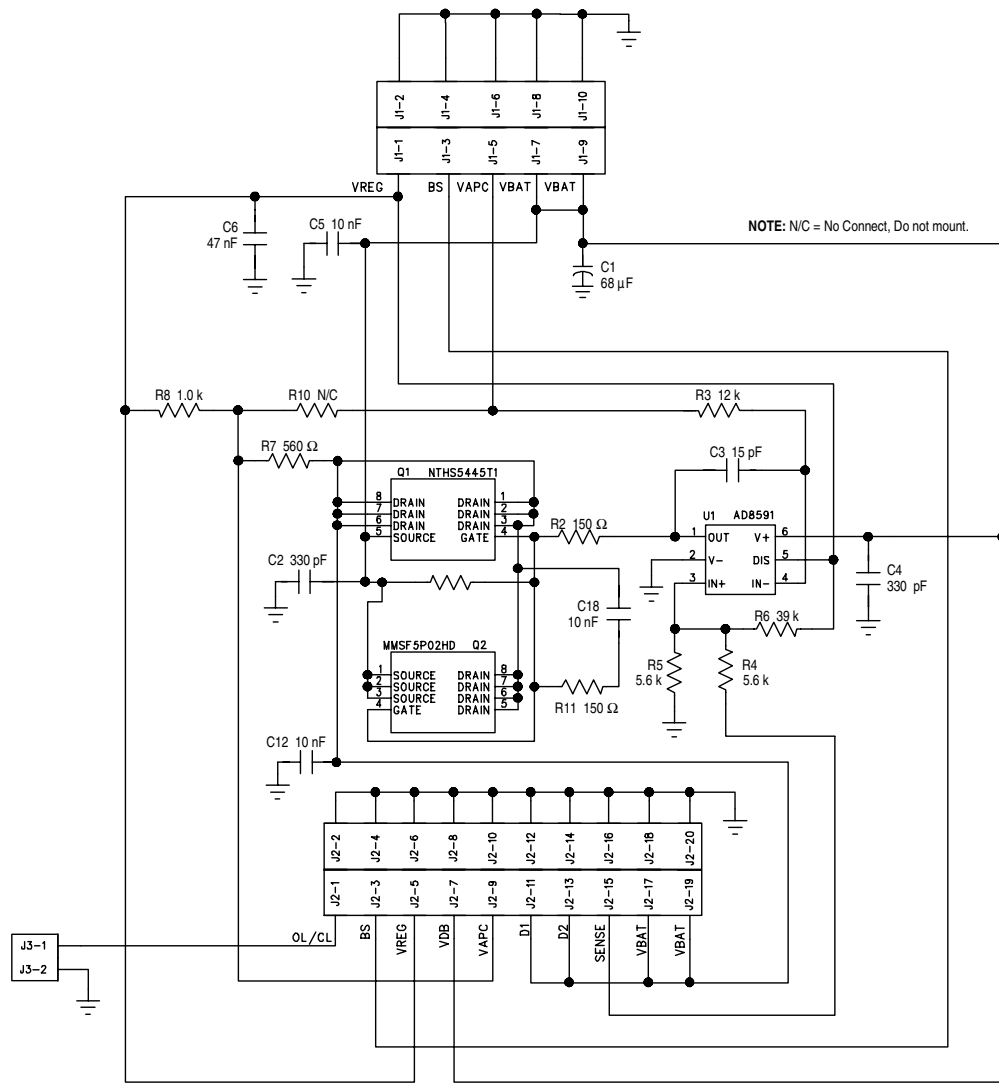

Figure 22. Power Amplifier Control Loop

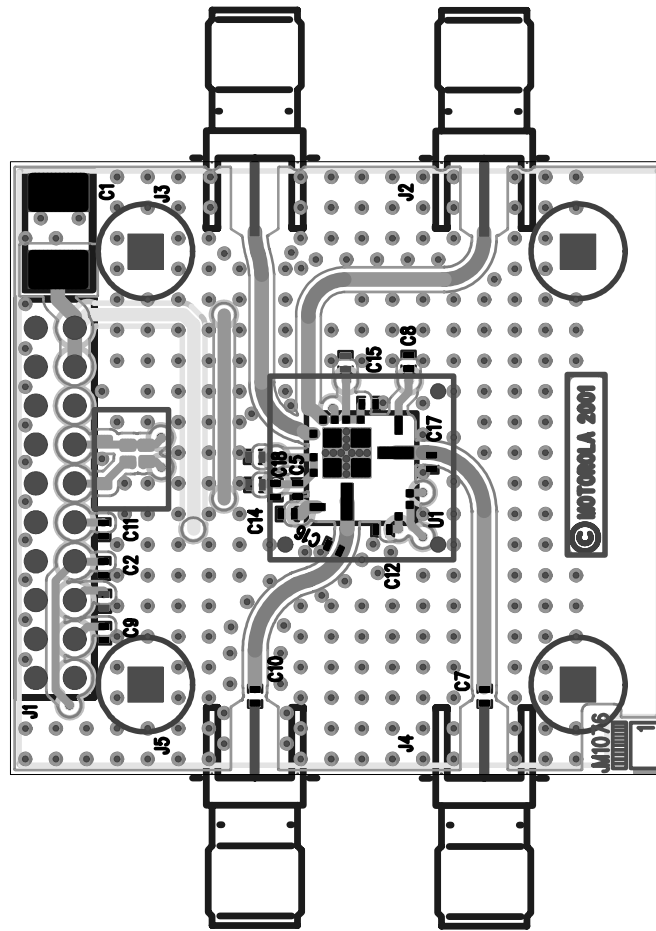

Figure 23. PA Evaluation Circuit PCB

Table 6. PA Evaluation Circuit PCB Bill of Materials

Reference	Value	Part Number	Manufacturer
C1, C3, C4, C6, C13	N/C - Do not mount		
C2	330 pF	GRM36COG330J50	Murata
C5	220 pF	GRM36X7R221K50	Murata
C7, C8, C12	22 pF	GRM36COG220J50	Murata
C9, C14, C15	10 nF	GRM36X7R103K25	Murata
C10	47 pF	GRM36COG470J50	Murata
C11	1.0 nF	GRM36X7R102K25	Murata
C16	6.8 pF	GRM36COG6R8J50	Murata
C17	3.9 pF	GRM36COG3R9J50	Murata
C18	100 nF	GRM36X7R104K25	Murata
J2, J3, J4, J5	50 $\Omega$	142-0711-821	Johnson

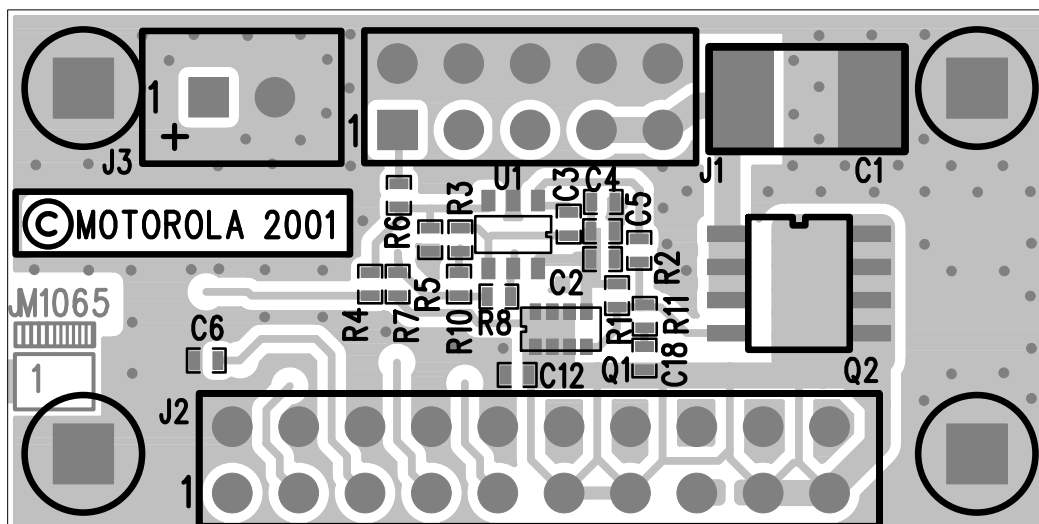

Figure 24. Power Amplifier Control Loop PCB

Table 7. Power Amplifier Control Loop PCB Bill of Materials

Reference	Value	Part Number	Manufacturer
C1	68 $\mu$ F	293D685X9020C	Sprague
C2	330 pF	GRM36COG330J50	Murata
C3	15 pF	GRM36COG150J50	Murata
C4	330 pF	GRM36x7R331K50	Murata
C5, C12, C18	10 nF	GRM36X7R103K25	Murata
C6	47 nF	GRM36X7R473K10	Murata
J1, J2, J3	DC connector		
Q1	Power MOSFET	NTHS5445T	ON Semiconductor
Q2	N/C - Do not mount		
R1, R8	1.0 k	CRG0402 5% 1 kO	NEOHM
R2	150 $\Omega$	CRG0402 5% 150 O	NEOHM
R3	12 k	CRG0402 5% 12 kO	NEOHM
R4, R5	5.6 k	CRG0402 5% 5.6 kO	NEOHM
R6, R10	N/C - Do not mount		
R7	560 $\Omega$	CRG0402 5% 560 O	NEOHM
R11	100 $\Omega$	CRG0402 5% 100 O	NEOHM
U1	CMOS Op Amp	AD8591	Analog Devices



## 5 Packaging Information

### Shipping, Packaging and Marking Information

Tape Width: 16.0 mm  
 Tape Pitch: 12 mm (part to part)  
 Reel Diameter: 330 mm (13 in)

Component Orientation: Parts are to be orientated with pin 1 side closest to the tape's round sprocket holes on the tape's trailing edge.

**Dry Pack:** This device meets Moisture Sensitivity Level (MSL) 3. Parts will be shipped in Dry Pack. Parts must be stored at 30°C and 60% relative humidity with time out of dry pack not to exceed 168 hours.

In the event that parts are not handled or stored within these limits, one of the following dry out procedures must be completed prior to reflow:

- 1) 40°C Dry Out: Bake devices at  $40^{\circ}\text{C} \leq T_A \leq 45^{\circ}\text{C}$ , 5% Relative Humidity for at least 192 hours.
- 2) Room Temperature Dry Out: Store devices at less than 20% Relative Humidity for at least 500 hours.

#### Marking:

- 1st line: Motorola Logo  
 2nd Line: Partnumber coded on 7 characters  
 3rd Line: Wafer lot number (coded on 6 characters) followed by wafer number (coded on 3 digits)  
 4th Line: Assy site code (on 1 or 2 characters), followed by Wafer Lot Number (coded on 1 or 2 characters), followed by Year (on 2 digits) and Workweek (on 2 digits).

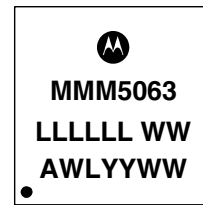

Marking  
(Top View)

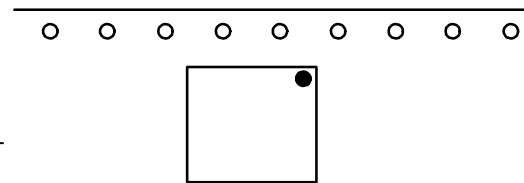

Tape & Reel Orientation  
(Top View)

Figure 25. Packaging Information

# Packaging Information

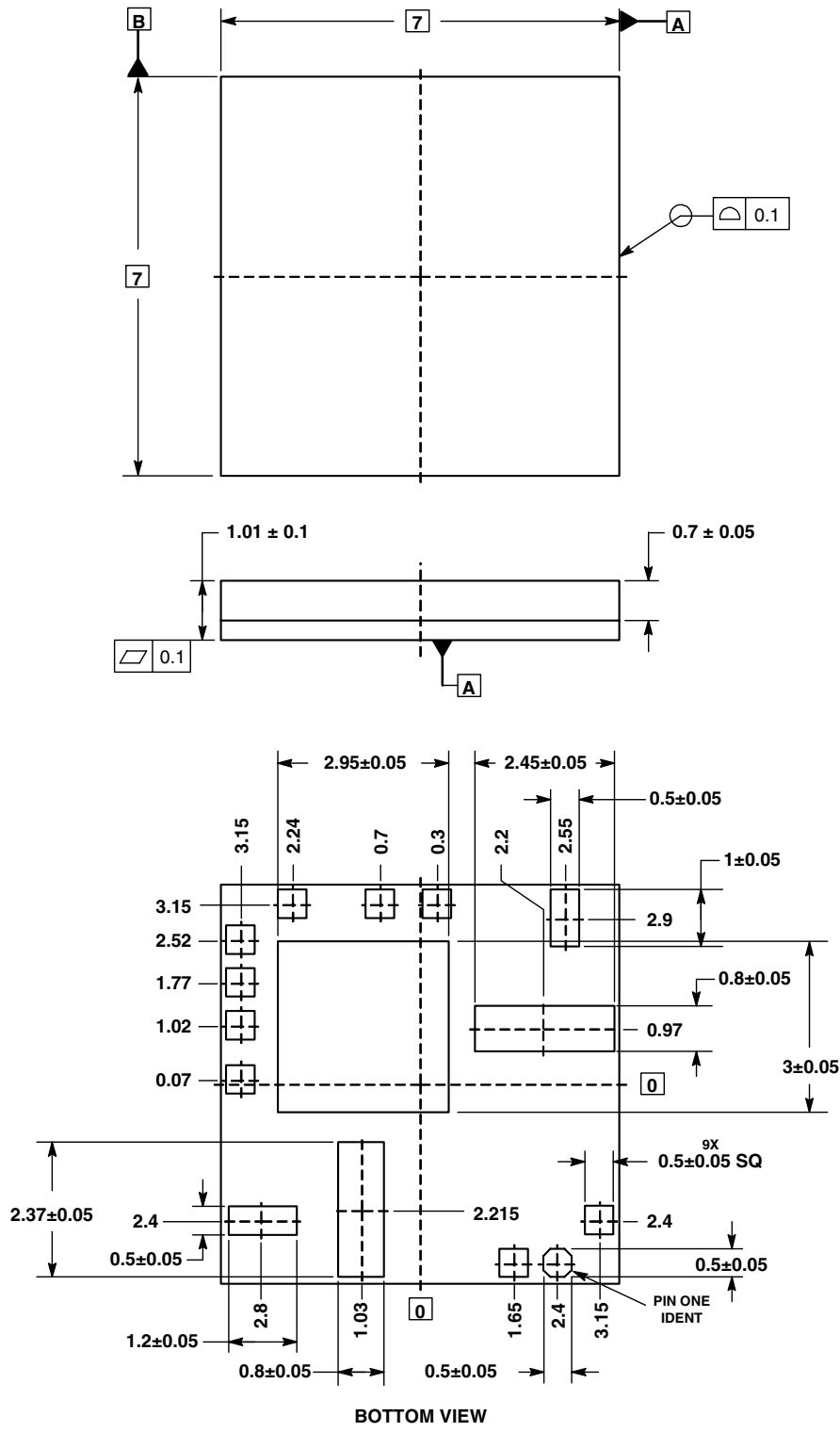

**Figure 26. Outline Dimensions for 7x7 mm Module**  
(Case 1383-02, Issue A)

## NOTES

**HOW TO REACH US:****USA/EUROPE/LOCATIONS NOT LISTED:**

Motorola Literature Distribution;  
P.O. Box 5405, Denver, Colorado 80217  
1-303-675-2140 or 1-800-441-2447

**JAPAN:**

Motorola Japan Ltd.; SPS, Technical Information Center,  
3-20-1, Minami-Azabu Minato-ku, Tokyo 106-8573 Japan  
81-3-3440-3569

**ASIA/PACIFIC:**

Motorola Semiconductors H.K. Ltd.; Silicon Harbour  
Centre, 2 Dai King Street, Tai Po Industrial Estate,  
Tai Po, N.T., Hong Kong  
852-26668334

**TECHNICAL INFORMATION CENTER:**

1-800-521-6274

**HOME PAGE:**

<http://www.motorola.com/semiconductors>

Information in this document is provided solely to enable system and software implementers to use Motorola products. There are no express or implied copyright licenses granted hereunder to design or fabricate any integrated circuits or integrated circuits based on the information in this document.

Motorola reserves the right to make changes without further notice to any products herein. Motorola makes no warranty, representation or guarantee regarding the suitability of its products for any particular purpose, nor does Motorola assume any liability arising out of the application or use of any product or circuit, and specifically disclaims any and all liability, including without limitation consequential or incidental damages. "Typical" parameters which may be provided in Motorola data sheets and/or specifications can and do vary in different applications and actual performance may vary over time. All operating parameters, including "Typicals" must be validated for each customer application by customer's technical experts. Motorola does not convey any license under its patent rights nor the rights of others. Motorola products are not designed, intended, or authorized for use as components in systems intended for surgical implant into the body, or other applications intended to support or sustain life, or for any other application in which the failure of the Motorola product could create a situation where personal injury or death may occur. Should Buyer purchase or use Motorola products for any such unintended or unauthorized application, Buyer shall indemnify and hold Motorola and its officers, employees, subsidiaries, affiliates, and distributors harmless against all claims, costs, damages, and expenses, and reasonable attorney fees arising out of, directly or indirectly, any claim of personal injury or death associated with such unintended or unauthorized use, even if such claim alleges that Motorola was negligent regarding the design or manufacture of the part.



Motorola and the Stylized M Logo are registered in the U.S. Patent and Trademark Office. All other product or service names are the property of their respective owners. Motorola, Inc. is an Equal Opportunity/Affirmative Action Employer.

© Motorola, Inc. 2003

MMM5063/D