



Am27S21/27S21A

1,024-Bit (256x4) Bipolar PROM

DISTINCTIVE CHARACTERISTICS

- High speed
- Highly reliable, ultra-fast programming Platinum-Silicide fuses
- High programming yield
- Low-current PNP inputs
- High-current open-collector and three-state outputs
- Fast chip select

GENERAL DESCRIPTION

The Am27S21 (256 words by 4-bits) is a Schottky TTL Programmable Read-Only Memory (PROM).

This device is only available in a three-state (Am27S21) output version. These outputs are compatible with low-

power Schottky bus standards capable of satisfying the requirements of a variety of microprogrammable controls, mapping functions, code version, or logic replacement. Easy word-depth expansion is facilitated by active LOW (\overline{G}_1 and \overline{G}_2) output enables.

BLOCK DIAGRAM

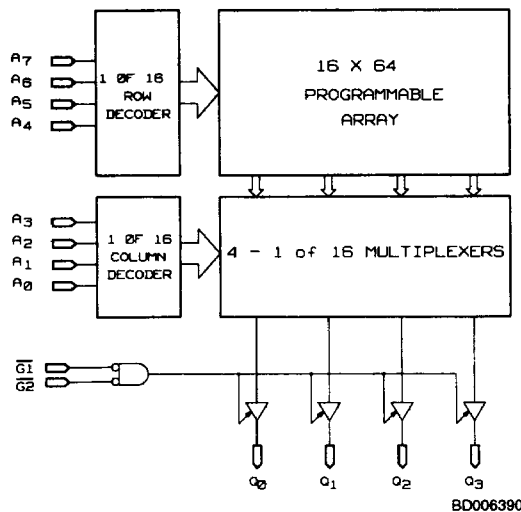

PRODUCT SELECTOR GUIDE

Three-State Part Number	Am27S21A		Am27S21	
	Address Access Time	30 ns	40 ns	45 ns
Operating Range	C	M	C	M

CONNECTION DIAGRAMS

Top View

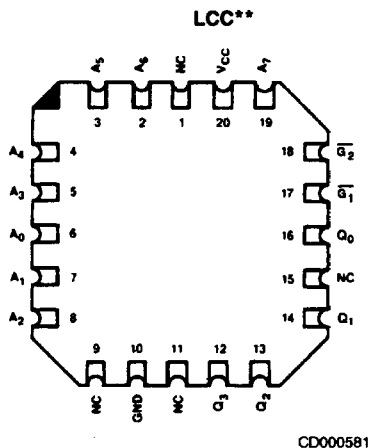
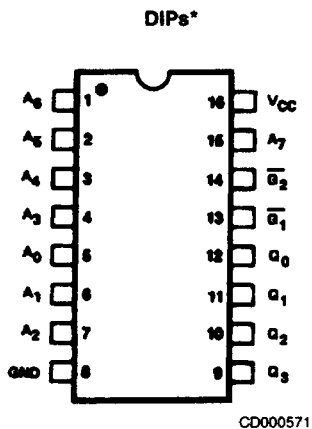

*Also available in a 16-Pin Flatpack. Pinout identical to DIPs.
 **Also available in a 20-Pin Square PLCC. Pinout identical to LCC.

Note: Pin 1 is marked for orientation.

LOGIC SYMBOL

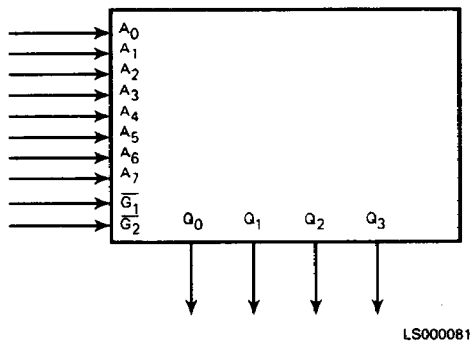

ORDERING INFORMATION

Standard Products

AMD standard products are available in several packages and operating ranges. The order number (Valid Combination) is formed by a combination of:

- a. Device Number
- b. Speed Option (if applicable)
- c. Package Type
- d. Temperature Range
- e. Optional Processing

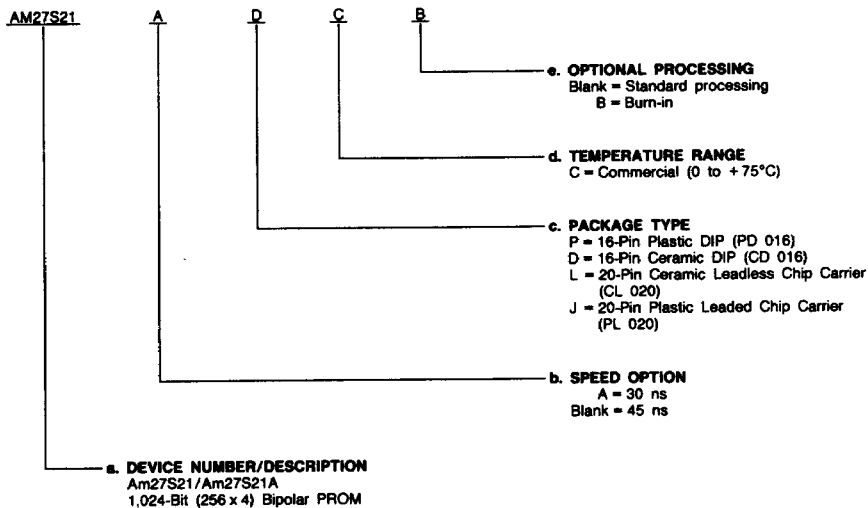

Valid Combinations	
AM27S21	DC, DCB, PC, PCB,
AM27S21A	LC, LCB, JC, JCB

Valid Combinations

Valid Combinations list configurations planned to be supported in volume for this device. Consult the local AMD sales office to confirm availability of specific valid combinations, to check on newly released combinations, and to obtain additional data on AMD's standard military grade products.

MILITARY ORDERING INFORMATION

APL Products

AMD products for Aerospace and Defense applications are available in several packages and operating ranges. APL (Approved Products List) products are fully compliant with MIL-STD-883C requirements. The order number (Valid Combination) for APL products is formed by a combination of:

- a. Device Number
- b. Speed Option (if applicable)
- c. Device Class
- d. Package Type
- e. Lead Finish

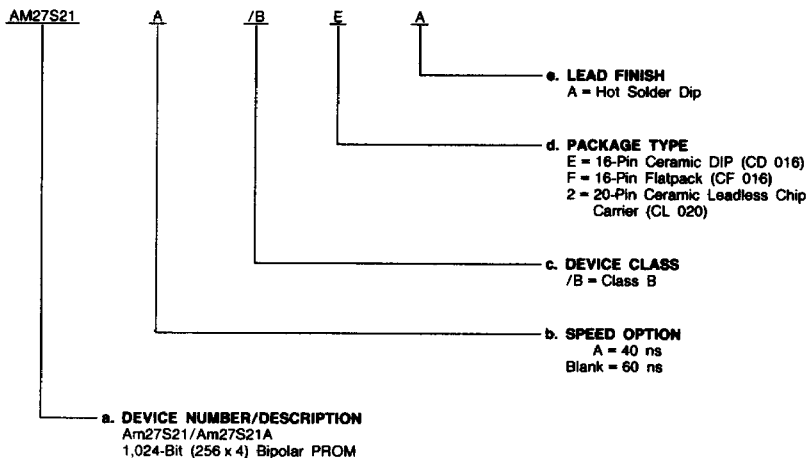

Valid Combinations	
AM27S21	/BEA, /BFA, /B2A
AM27S21A	

Valid Combinations

Valid Combinations list configurations planned to be supported in volume for this device. Consult the local AMD sales office to confirm availability of specific valid combinations or to check for newly released valid combinations.

Group A Tests

Group A tests consist of Subgroups
 1, 2, 3, 7, 8, 9, 10, 11.

MILITARY BURN-IN

Military burn-in is in accordance with the current revision of MIL-STD-883, Test Method 1015, Conditions A through E. Test conditions are selected at AMD's option.

PIN DESCRIPTION

A₀ - A₇ Address inputs (Inputs)

The 8-bit field presented at the address inputs selects one of 256 memory locations to be read from.

Q₀ - Q₃ Data Output Port (Outputs)

The output whose state represents the data read from the selected memory locations.

$\overline{G}_1, \overline{G}_2$ Output Enable

Provides direct control of the Q output buffers. Outputs disabled force all open-collector outputs to an OFF state

and all three-state outputs to a floating or high-impedance state.

$$\text{Enable} = \overline{G}_1 \cdot \overline{G}_2$$

$$\text{Disable} = \overline{G}_1 \cdot \overline{G}_2 = G_1 + G_2$$

VCC Device Power Supply Pin

The most positive of the logic power supply pins.

GND Device Power Supply Pin

The most negative of the logic power supply pins.

FUNCTIONAL DESCRIPTION

Applying The Am27S21

Typical application of the Am27S21 is shown below. The Am27S21 is employed as mapping ROMs in a microprogram computer control unit. The eight-bit macroinstruction from main memory is brought into the A₀ - A₇ inputs of the mapping ROM array. The instruction is mapped into a 12-bit address

space with each PROM output supplying 4 bits. The 12 bits of address are then supplied to the "D" inputs of the Am2910 as a possible next address source for microprogram memory. The MAP output of the Am2910 is connected to the \overline{G}_1 input of the Am27S21 such that when the \overline{G}_1 input is HIGH, the outputs of the PROMs are in the three-state mode in the case of the Am27S21. The \overline{G}_2 input is grounded; thus data from other sources are free to drive the D inputs of the Am2910 when MAP is HIGH.

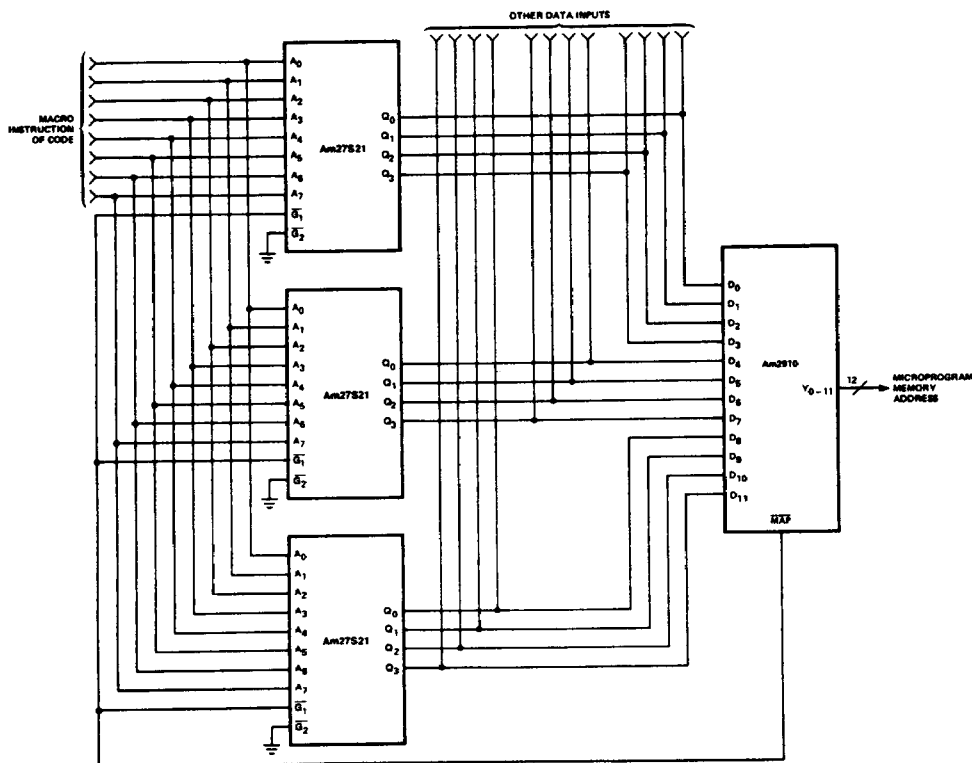

AF000232

Figure 1. Microprogramming Instruction Mapping

ABSOLUTE MAXIMUM RATINGS

Storage Temperature	-65 to +150°C
Ambient Temperature with Power Applied	-55 to +125°C
Supply Voltage	-0.5 V to +7.0 V
DC Voltage Applied to Outputs (Except During Programming)	-0.5 V to +V _{CC} Max.
DC Voltage Applied to Outputs During Programming	21 V
Output Current into Outputs During Programming (Max. Duration of 1 sec)	250 mA
DC Input Voltage	-0.5 V to +5.5 V
DC Input Current	-30 mA to +5 mA

Stresses above those listed under ABSOLUTE MAXIMUM RATINGS may cause permanent device failure. Functionality at or above these limits is not implied. Exposure to absolute maximum ratings for extended periods may affect device reliability.

OPERATING RANGES

Commercial (C) Devices	
Ambient Temperature (T _A)	0 to +75°C
Supply Voltage (V _{CC})	+4.75 V to +5.25 V
Military (M) Devices*	
Case Temperature (T _C)	-55 to +125°C
Supply Voltage (V _{CC})	+4.5 V to +5.5 V

Operating ranges define those limits between which the functionality of the device is guaranteed.

*Military product 100% tested at T_C +25°C, +125°C, and -55°C.

DC CHARACTERISTICS over operating ranges unless otherwise specified (for APL Products, Group A, Subgroups 1, 2, 3 are tested unless otherwise noted)

Parameter Symbol	Parameter Description	Test Conditions	Min.	Typ.	Max.	Unit
V _{OH} (Note 1)	Output HIGH Voltage	V _{CC} = Min., I _{OH} = -2.0 mA V _{IN} = V _{IH} or V _{IL}	2.4			V
V _{OL}	Output LOW Voltage	V _{CC} = Min., I _{OL} = 16 mA V _{IN} = V _{IH} or V _{IL}			0.45	V
V _{IH}	Input HIGH Level	Guaranteed input logical HIGH voltage for all inputs (Note 2)	2.0			V
V _{IL}	Input LOW Level	Guaranteed input logical LOW voltage for all inputs (Note 2)			0.8	V
I _{IL}	Input LOW Current	V _{CC} = Max., V _{IN} = 0.45 V			-0.250	mA
I _{IH}	Input HIGH Current	V _{CC} = Max., V _{IN} = 2.7 V			25	μA
I _{SC} (Note 1)	Output Short Circuit Current	V _{CC} = Max., V _{OUT} = 0.0V (Note 3)	-20		-90	mA
I _{CC}	Power Supply Current	All inputs = GND, V _{CC} = Max.			130	mA
V _I	Input Clamp Voltage	V _{CC} = Min., I _{IN} = -18 mA			-1.2	V
I _{CEX}	Output Leakage Current	V _{CC} = Max., V _{G1} = 2.4 V (Note 1)			40	μA
		V _O = V _{CC} V _O = 0.4 V			-40	
C _{IN}	Input Capacitance	V _{CC} = 5.00 V, T _A = 25°C V _{IN} /V _{OUT} = 2.0 V, @ f = 1 MHz (Note 4)		4		pF
C _{OUT}	Output Capacitance			8		

Notes: 1. This applies to three-state devices only.

2. V_{IL} and V_{IH} are input conditions of output tests and are not themselves directly tested. V_{IL} and V_{IH} are absolute voltages with respect to device ground and include all overshoots due to system and/or tester noise. Do not attempt to test these values without suitable equipment.

3. Not more than one output should be shorted at a time. Duration of the short circuit should not be more than one second.

4. These parameters are not 100% tested, but are evaluated at initial characterization and at any time the design is modified where capacitance may be affected.

SWITCHING CHARACTERISTICS over operating ranges unless otherwise specified (for APL Products, Group A, Subgroups 9, 10, 11 are tested unless otherwise noted*)

No.	Parameter Symbol	Parameter Description	Am27S21A				Am27S21				Unit
			COM'L		MIL		COM'L		MIL		
			Min.	Max.	Min.	Max.	Min.	Max.	Min.	Max.	
1	TAVQV	Address Valid to Output Valid Access Time		30		40		45		60	ns
2	TGVQZ	Delay from Output Enable Valid to Output Hi-Z		20		25		20		30	ns
3	TGVQV	Delay from Output Enable Valid to Output Valid		20		25		20		30	ns

See also Switching Test Circuits.

Notes: 1. Tests are performed with input transition time of 5 ns or less, timing reference levels of 1.5 V, and input pulse levels of 0 to 3.0 V using test load in A under Switching Test Circuits.

2. TGVQZ is measured at steady state HIGH output voltage - 0.5 V and steady state LOW output voltage + 0.5 V output levels using the test load in B under Switching Test Circuits.

*Subgroups 7 and 8 apply to functional tests.

SWITCHING TEST CIRCUITS

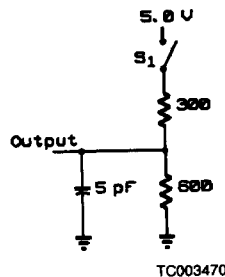
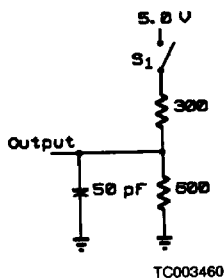





A. Output Load for all tests except TGVQZ

B. Output Load for TGVQZ

- Notes: 1. All device test loads should be located within 2" of device output pin.
 2. S₁ is open for Output Data HIGH to Hi-Z and Hi-Z to Output Data HIGH tests. S₁ is closed for all other AC tests.
 3. Load capacitance includes all stray and fixture capacitance.

SWITCHING WAVEFORMS

KEY TO SWITCHING WAVEFORMS

WAVEFORM	INPUTS	OUTPUTS
 	MUST BE STEADY	WILL BE STEADY
	MAY CHANGE FROM H TO L	WILL BE CHANGING FROM H TO L
	MAY CHANGE FROM L TO H	WILL BE CHANGING FROM L TO H
	DON'T CARE; ANY CHANGE PERMITTED	CHANGING; STATE UNKNOWN
	DOES NOT APPLY	CENTER LINE IS HIGH IMPEDANCE "OFF" STATE

KS000010

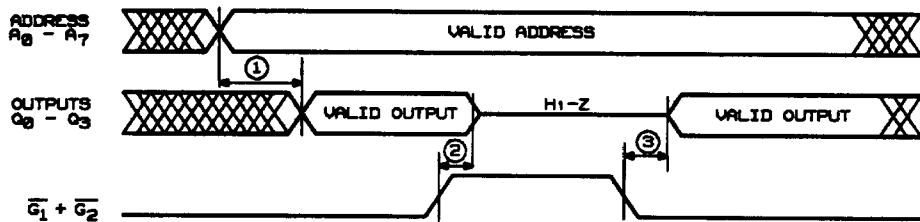

WF021170