



# EK-01 Evaluation Kit

## User Guide

### Contents

I. Package contents:	1
II. Introduction:	1
III. Installation:	2
III.A. Software:	2
III.B. Hardware:	2
III.C. Initial configuration:	3
III.D. Digital Sensors	4
III.D.1. Data Logging	5
III.D.2. Changing the I2C Address	7
III.D.3. Additional Data Acquisition Options	7
IV. Appendix A: Windows OS Environment	8
V. Appendix B: Part and Adapter table	10
VII. Appendix C: Schematics	11
VII. Appendix D: Summary	15

### I. Package contents:

- 1ea EK-01 PCB Assembly
- 1ea DIG-01 Adapter Board for DLV /DLVR Series preinstalled on EK-01 PCB Assembly
- 1ea DIG-08 Adapter Board for DLH /DLHR/DLLR Series
- 1ea USB cable *Micro-B to Standard-A*
- 1ea USB memory drive (includes: Evaluation Software, User guide & Product Catalog)
- 1ea Pressure Tubing
- N/A Pressure Sensor (Sold separately)

### II. Introduction:

The EK-01 Evaluation Kit provides a convenient means of connecting various digital output All Sensors products for testing and evaluation. The accompanying Windows based Evaluation software provides direct display of live readings and the ability to save data continuously to a CSV file.

### III. Installation:

#### III.A. Software:

Windows Versions 7 and later include all necessary operating system components by default, so no further preparation is required.

If you are using Windows XP or Vista, verify that your system has .NET 2 support installed: *See Appendix A.*

Copy the Evaluation application from the included USB memory drive to the Desktop folder (or other convenient location).

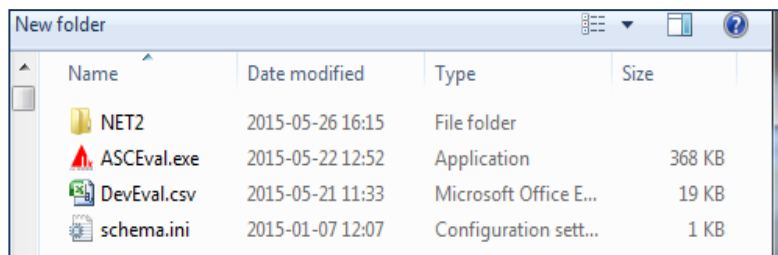

Figure 1

No installer is needed for the application: just run the **ASCEval.exe** file (Figure 1).

#### III.B. Hardware:

Using the USB cable provided, or any Micro-B to Standard-A cable, connect the board to a powered on PC. The EK-01 will be identified as a generic USB Input Device, and Windows will install its standard class drivers. These are included in Windows, so there is no need for further driver installation. Note that it may take several minutes for Windows to extract necessary files from its DriverStore archive.

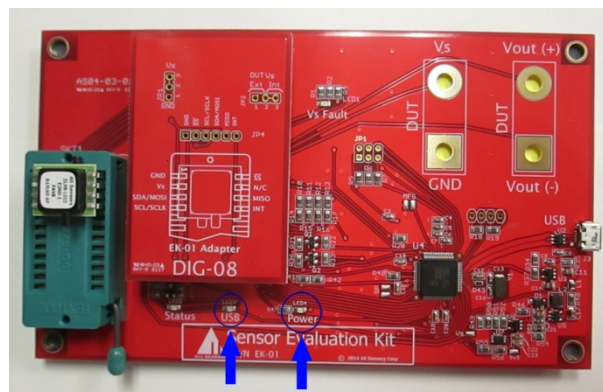

Figure 2

Verify that both the green 'Power' LED and the amber 'USB' LED are illuminated (Figure 2).

If not, unplug cable and connect to a different port on the PC.

**III.C. Initial configuration:**

Start the **ASCEval.exe** application. The Eval Board does not need to be connected (Figure 3).

In the 'DEVICE TYPE' section, select the 'Product Family' and 'Device' matching the sensor you are testing (Figure 3).

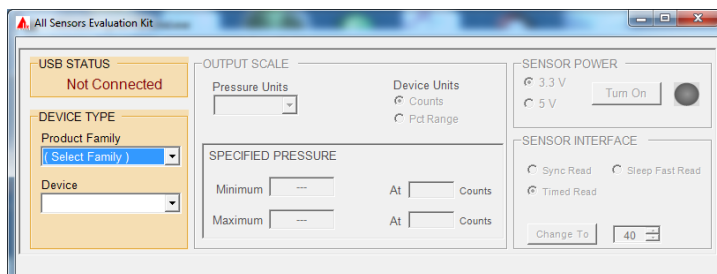

Figure 3

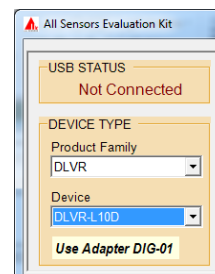

Figure 4

The appropriate Device Adapter will then be listed in the 'Device' selection (Figure 4):

Install the appropriate Device Adapter onto the Eval Board: keep the adapter parallel to the PCB and push both ends down evenly (Figure 5).

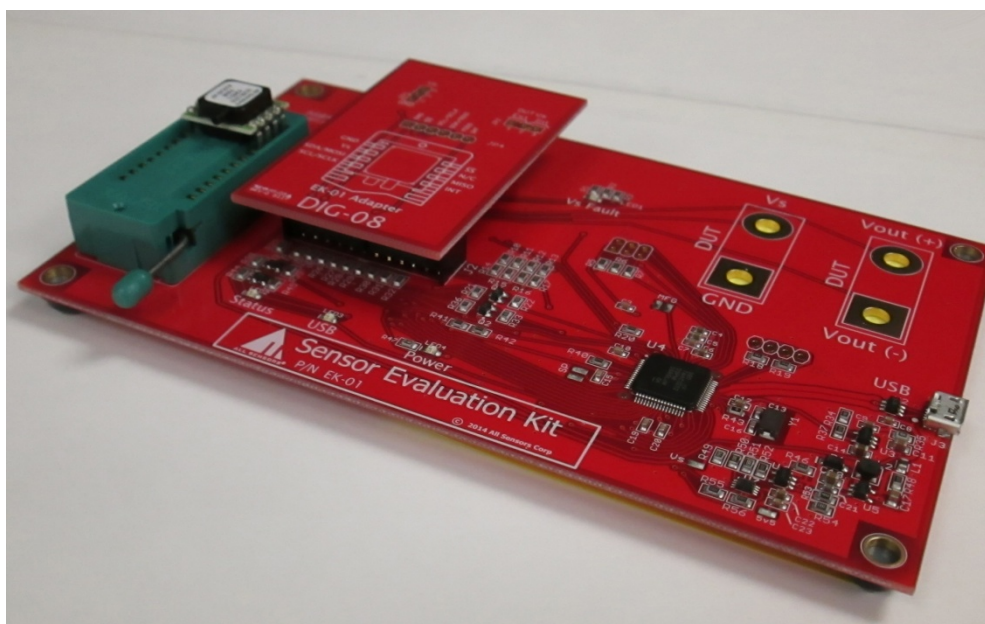

Figure 5

Each device adapter will support multiple product families. Check the adapter instructions in *Appendix B* for information on tubing connections to the pressure ports of the sensor.

### III.D. Digital Sensors

Install the pressure sensor in the ZIF socket as shown in Figure 6.

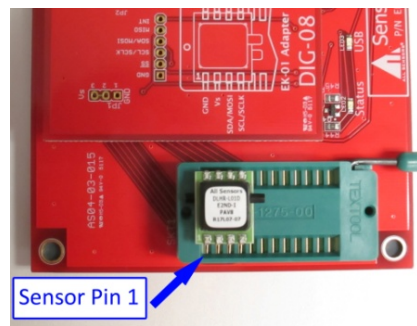

Figure 6

Refer to Appendix B1 or the product datasheet for pressure tube connection to the pressure port.

Start the **ASCEval.exe** application. Connect the Evaluation Board to a PC USB port; verify that the 'Power' and 'USB' LEDs go on. The 'USB STATUS' in the top-left corner of the application window should report 'Connected'.

Select the 'Product Family' and 'Device' for the installed sensor.

For DLV and DLVR sensors select the supply voltage option of your device.

Click the 'Turn On' button to switch on power to the sensor (Figure 7).

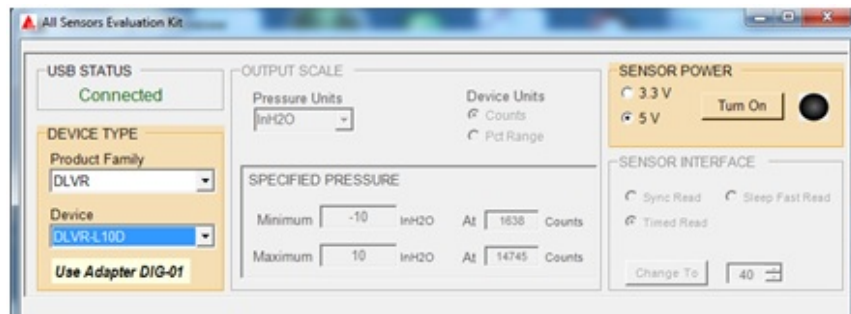

Figure 7

At this time, you can select the Sample Interval and the number of samples averaged before reporting (Figure 8). The method of averaging is a simple arithmetic mean of each set of N samples, so the reading will update every N sample intervals.



Figure 8

Click 'Start Reading' to display continuously updated values (Figure 9).  
 Click 'Stop Reading' then 'Turn Off' before removing sensor from socket.

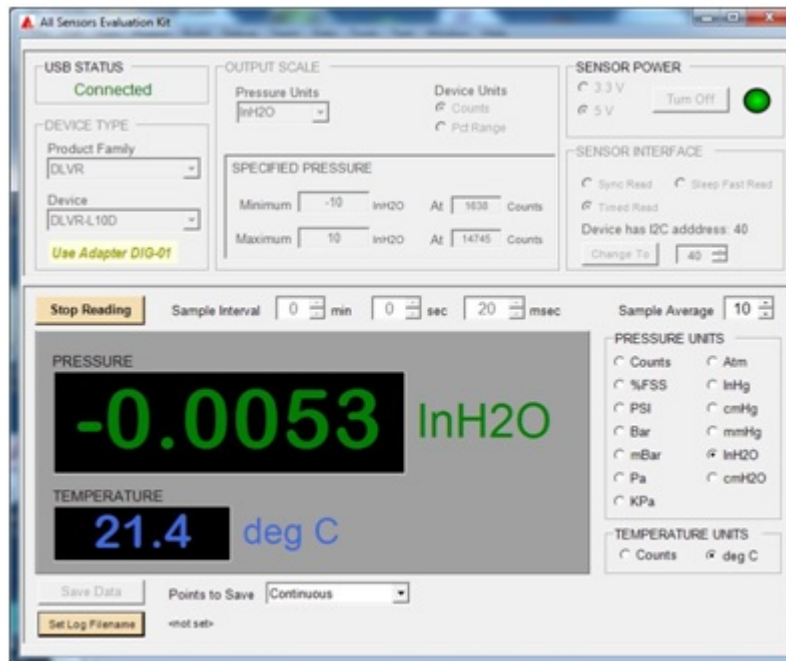

Figure 9

If at any point the program appears to become unresponsive to button actions, simply disconnect and reconnect the USB cable.

### III.D.1. Data Logging

While the Eval Board hardware and software can receive data at up to 2000 points per second, the program display is limited to an update interval of about 200ms. Each received data reading (or calculated average of readings) can be saved to a comma-separated values (CSV format) file at the full data rate.

For lower speed applications, data can be continuously saved for days at a time.

Once a filename is defined (by clicking 'Set Log Filename'), the 'Save Data' button is enabled.

**Data can be saved continuously or until a fixed number of points have been acquired, as determined by the 'Points to Save' control (Figure 10).**

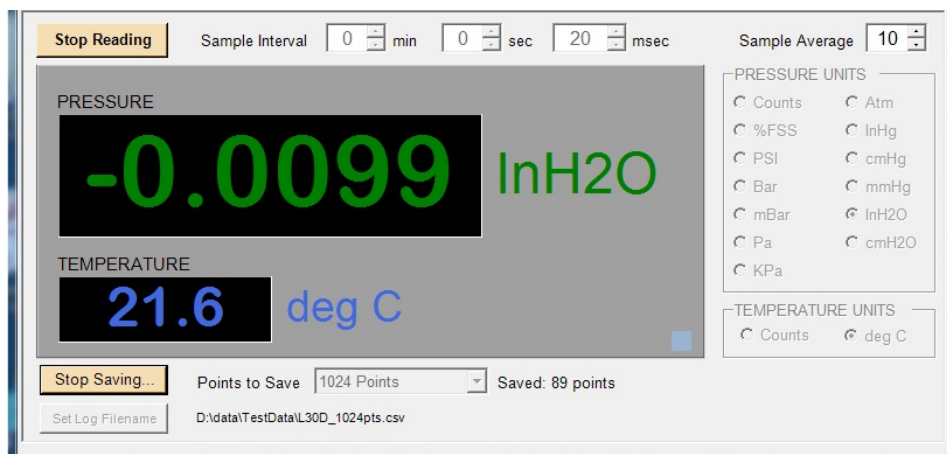

Figure 10

	A	B	C	D	E	F
1	-----> Starting capture: 2015-05-27 11:31:07					
2	P Units: InH2O; T Units: deg C; Average of 1 points					
3	Status: 0 = No Error    2 = Stale data    3 = Fault					
4	Sample interval: 20 msec					
5	Time (s)	Sample #	Pressure	Temperature	Points in Report	Status
6	3.0441741	1	-0.02976	21.7	1	0
7	3.0511745	2	-0.02976	21.7	1	0
8	3.0661753	3	-0.02976	21.7	1	0
9	3.0861765	4	-0.02976	21.7	1	0
10	3.1061776	5	0.00229	21.7	1	0
11	3.1261788	6	-0.01602	21.7	1	0
12	3.1461799	7	-0.01602	21.7	1	0
13	3.1661811	8	-0.02518	21.7	1	0
14	3.1861822	9	-0.02518	21.7	1	0
15	3.2061834	10	-0.01602	21.7	1	0
16	3.2261845	11	-0.02518	21.7	1	0
17	3.2461856	12	-0.02518	21.7	1	0
18	3.2661868	13	-0.02518	21.7	1	0
19	3.2861879	14	-0.00229	21.7	1	0
20	3.3061891	15	-0.02976	21.7	1	0
21	3.3261902	16	-0.02976	21.7	1	0
22	3.3461914	17	-0.02976	21.7	1	0
23	3.3661925	18	-0.02976	21.7	1	0

Figure 11

The CSV file format is shown above (Figure 11).

The timestamp of reception of the USB data packet is shown, as well as number of points in the packet (Report). Data is saved in the units and averaging selected for display in the program.

If available, Temperature data is recorded as well. For each iteration of 'Save Data' using the same filename, readings are appended to the end of the file.

**III.D.2. Changing the I2C Address**

For I2C - Interface versions of these parts, the I2C address can be changed from the factory default value:

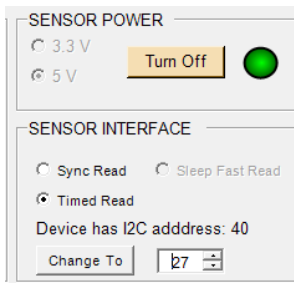

Figure 12

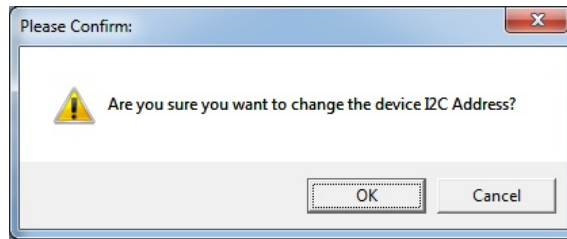

Figure 13

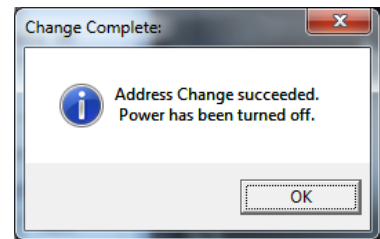

Figure 14

After device power-on, adjust the address and then click 'Change To' (Figure 12).

After clicking OK to the confirmation dialog and the completion dialog (Figures 13, 14), the device will be off, with address changed. The sensor may be removed at this time.

If you are adjusting multiple parts, this sequence allows a rapid cycle of each unit through the process.

**III.D.3. Additional Data Acquisition Options**

All DLV/DLVR parts can be read in a timed polling loop, as performed by the SENSOR INTERFACE 'Timed Read' selection (the program default for all devices). Devices ordered with the SPI interface option are limited to this method only, as shown in Figure 15 below.

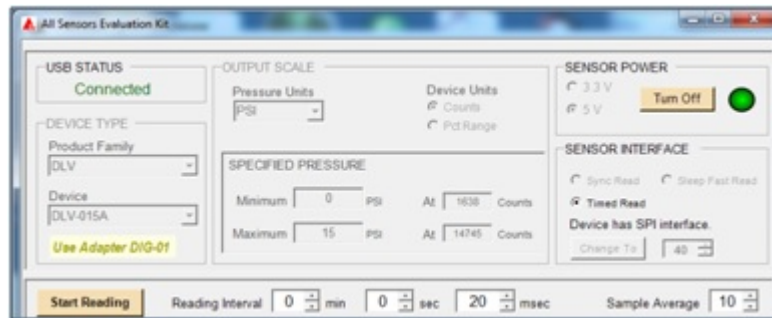

Figure 15

The devices with the I2C interface in DIP or J-Lead packages, which include the INT pin, can also support one of two additional communication methods synchronous to updates in the sensor output.

**III.D.3.a) Parts without the Sleep Mode option**

The 'Sync Read' interface selection, shown in Figure 16, will cause the time interval controls to be disabled. All readings are transferred from the sensor as soon as the INT pin indicates new data is available. This option eliminates 'stale data' values that may occur when polling faster than the sensor update rate.

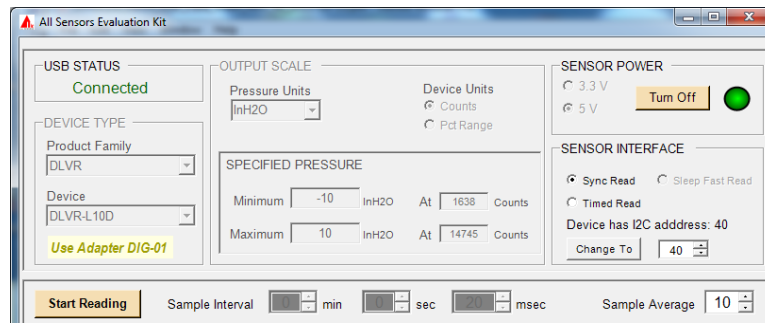

Figure 16

**III.D.3.b) Parts with the Sleep Mode option**

A 'Sleep Fast Read' method is also available (Figure 17).

This selection provides the fastest possible data updates. The INT pin triggers a data read as soon as a new value is available. Immediately following, the *Wake Pressure* command is sent, which allows near-zero sleep time for the sensor. This command skips the internal ADC auto-zero and temperature measurement phases executed in all other interface modes, and *only* performs sensor bridge measurement.

When the 'Timed Read' Sensor Interface option is selected for Sleep Mode parts, the *Wake All* command is used instead, which *does* include internal ADC auto-zero and temperature measurement on each reading.

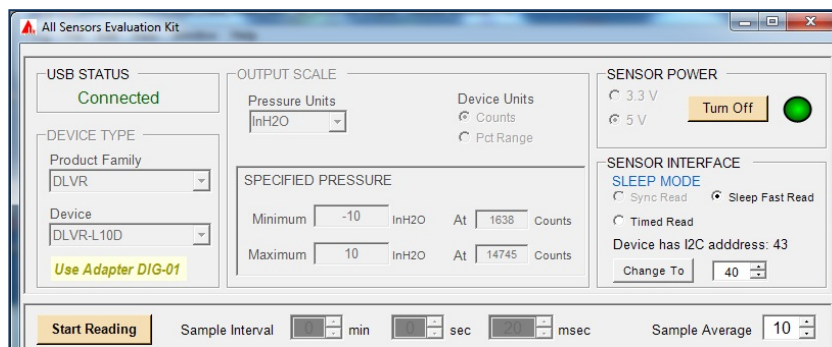

Figure 17

See device datasheets for further information.

**IV. Appendix A: Windows OS Environment**

A particular Windows XP or Windows Vista system may not have the .NET 2.0 framework installed, depending on previous software and Windows Update installations. To check this:

In the application NET2 folder, run **CheckNET2.exe** (Figure 18).

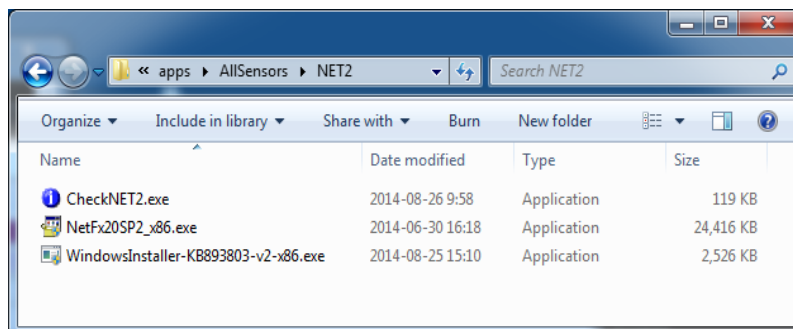

Figure 18



If a dialog appears as shown below (Figure 19), no further action is needed.

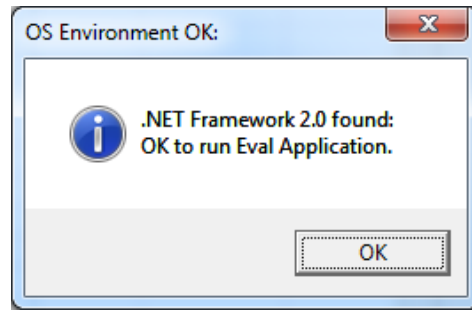

Figure 19

If the .NET 2.0 framework was *not* found, run the Microsoft Update file **NetFx20SP2\_x86.exe**.

This will install the Microsoft- provided .NET 2.0 framework on your system.

When complete, verify success of the installation by repeating the **CheckNET2.exe** test.

In rare cases, the .NET installation will fail with a message indicating that the Windows Installer component also needs updating. If this occurs, run the provided file **WindowsInstaller-KB893803-v2-x86.exe** then retry the NET2 installation.

Windows, Windows XP, Windows Vista, and .NET are trademarks of Microsoft Corp.

**V. Appendix B: Part and Adapter table**

Product Family	Product Datasheet(s)	Adapter Board	Evaluation Software Compatibility	Positive Pressure Port
DLV	DS-0336	DIG-01	YES	B
DLVR	DS-0300	DIG-01	YES	B
DLH	DS-0355	DIG-08	YES	B
DLHR	DS-0350	DIG-08	YES	B
DLLR	DS-0358	DIG-08	YES	B



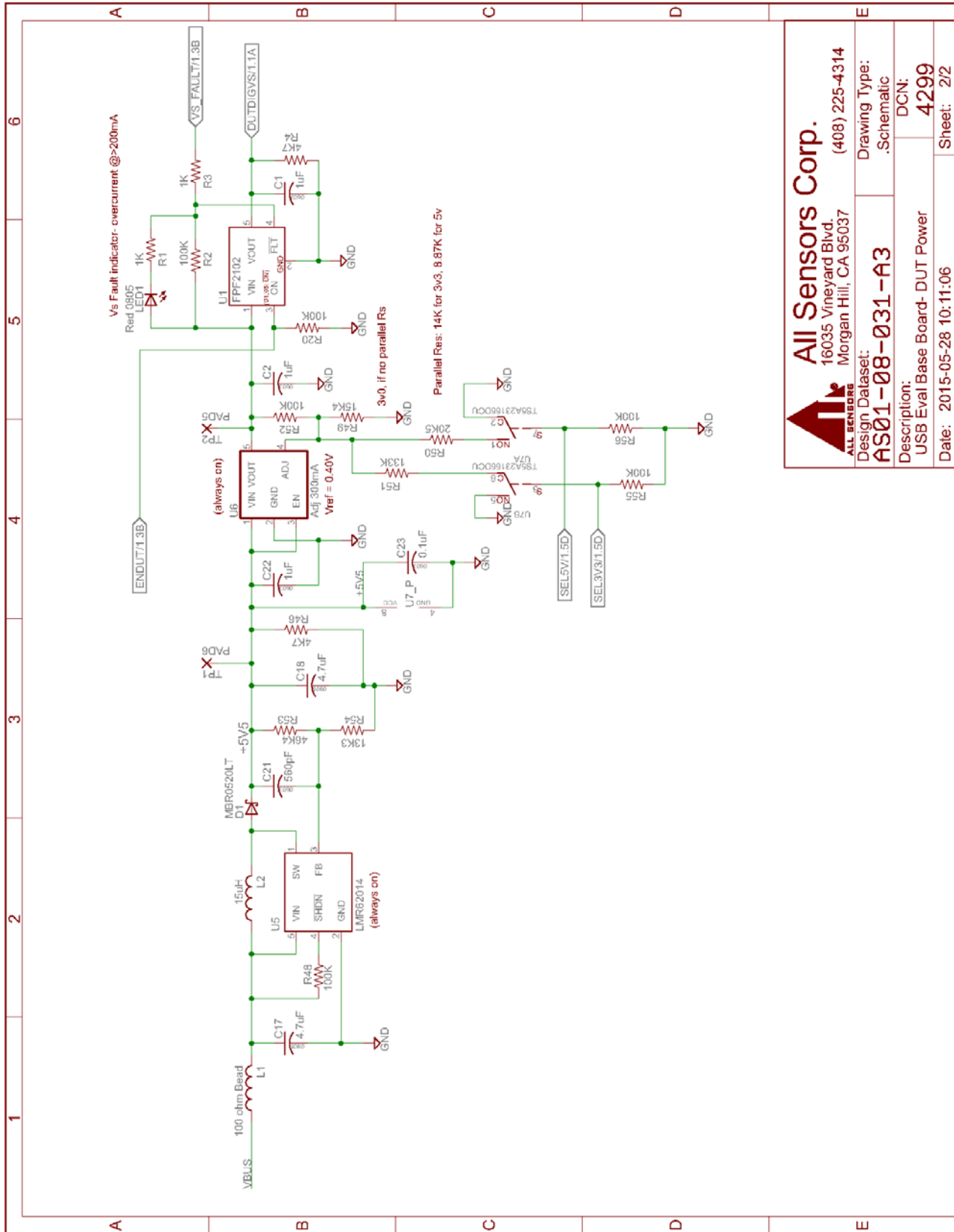

 <b>All Sensors Corp.</b> 16035 Vineyard Blvd. Morgan Hill, CA 95037 (408) 225-4314	
Design Dataset:	AS01-08-031-A3
Drawing Type:	.Schematic
DCN:	4299
Description:	USB Eval Base Board- DUT Power
Date:	2015-05-28 10:11:06
Sheet:	2/2

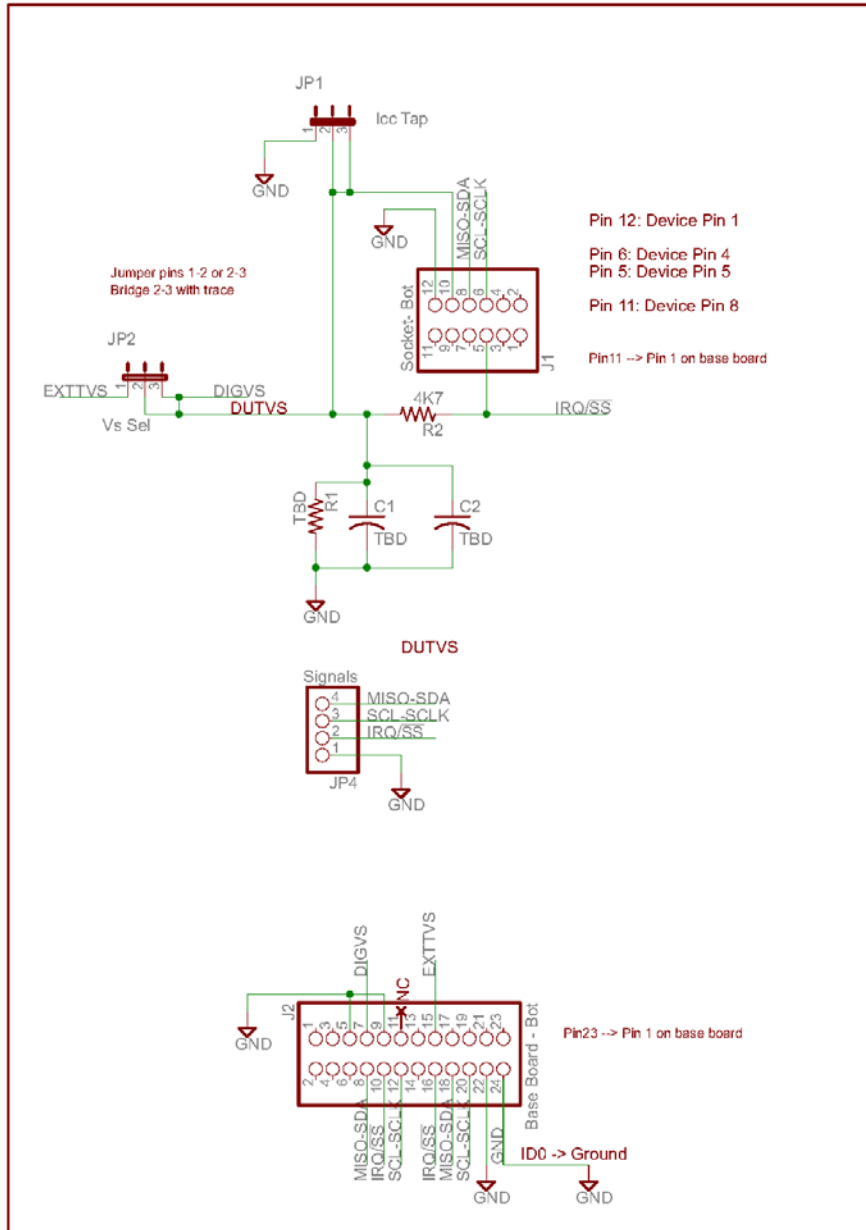

**All Sensors Corp.**  
 16035 Vineyard Blvd.  
 Morgan Hill, CA 95037 (408) 225-4314

Design Dataset: **AS01-08-033-A2** Drawing Type: .Schematic

A2	SMT parts, add cap	18 Mar 2015	Description: <b>USB Eval Adapter DIG-01</b>	DCN: <b>5034</b>
A	Initial Release	02 Dec 2014	Date: 2015-03-19 11:50:23	Sheet: 1/1
Rev	Description	Date		

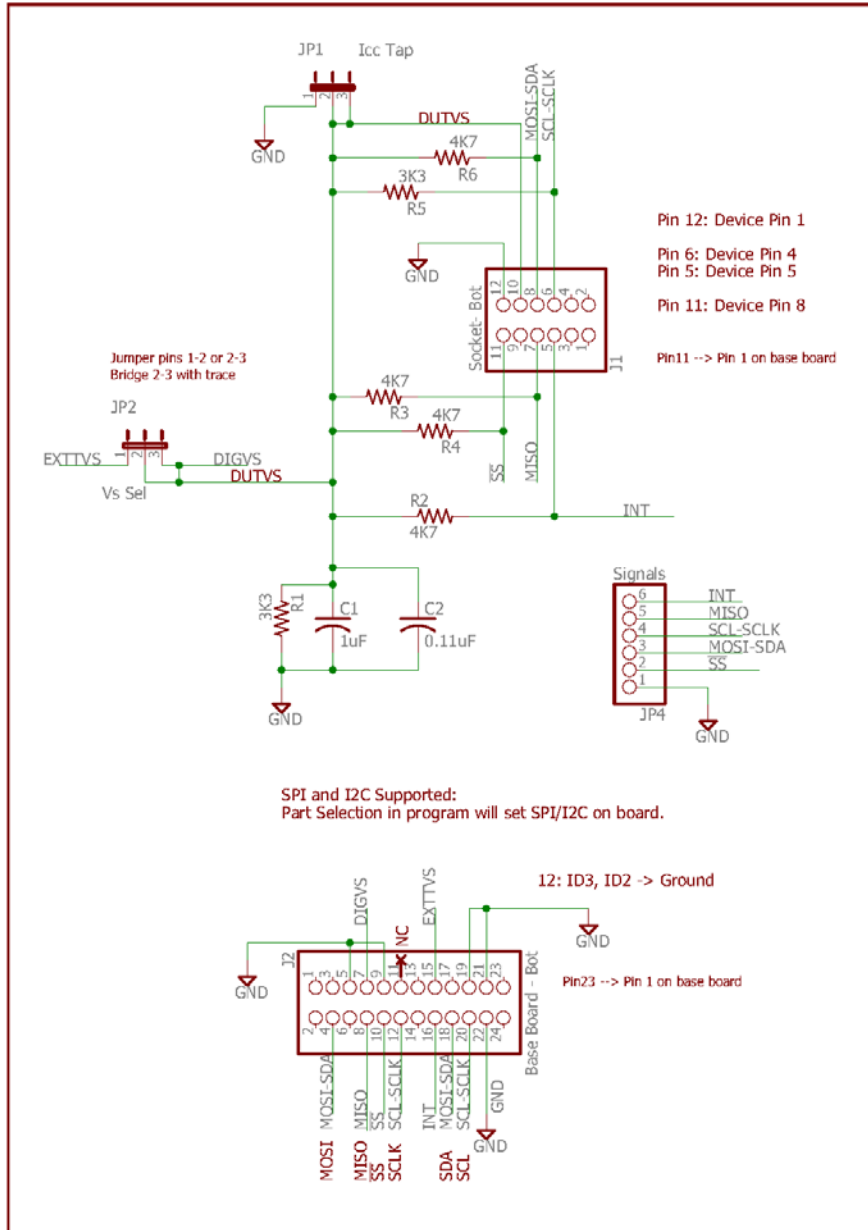

**All Sensors Corp.**  
 16035 Vineyard Blvd.  
 Morgan Hill, CA 95037 (408) 225-4314

Design Dataset: **AS01-08-046-A2** Drawing Type: .Schematic

Description: **USB Eval Adapter DIG-08** DCN: **6400**

A	Initial Release	31 May 2016
Rev	Description	Date

Date: 2016-10-25 10:37 Sheet: 1/1

# Summary: Sensor Evaluation Kit EK-01

<b>General description</b>	Easily evaluate Digital Sensors ZIF socket allows quick electrical connection
<b>Sensor Type</b>	Digital
<b>Measurement</b>	Display data in one of 12 units of measurement
<b>Data Display</b>	Capture data to CSV text file Includes sample index and timestamp
<b>Driver</b>	Uses standard Windows in-box USB drivers No separate download or CD needed
	Includes: evaluation board, software, 2 adapters & 1 USB cable

List of supported All Sensors product series and required adapters

EK-01 Product Series Adapter Cross Reference	
Series	Adapter
DLV	DIG-01
DLVR	DIG-01
DLH	DIG-08
DLHR	DIG-08
DLLR	DIG-08

