

TLE206x, TLE206xA, TLE206xB
EXCALIBUR JFET-INPUT HIGH-OUTPUT-DRIVE
μPOWER OPERATIONAL AMPLIFIERS
SLOS193B – FEBRUARY 1997 – REVISED MAY 2004

- **2× Bandwidth (2 MHz) of the TL06x and TL03x Operational Amplifiers**
- **Low Supply Current . . . 290 μA/Ch Typ**
- **On-chip Offset Voltage Trimming for Improved DC Performance**
- **High Output Drive, Specified into 100-Ω Loads**
- **Lower Noise Floor Than Earlier Generations of Low-Power BiFETs**

description

The TLE206x series of low-power JFET-input operational amplifiers doubles the bandwidth of the earlier generation TL06x and TL03x BiFET families without significantly increasing power consumption. Texas Instruments Excalibur process also delivers a lower noise floor than the TL06x and TL03x. On-chip zener trimming of offset voltage yields precision grades for dc-coupled applications. The TL206x devices are pin-compatible with other Texas Instruments BiFETs; they can be used to double the bandwidth of TL06x and TL03x circuits or to reduce power consumption of TL05x, TL07x, and TL08x circuits by nearly 90%.

BiFET operational amplifiers offer the inherently-higher input impedance of the JFET-input transistors, without sacrificing the output drive associated with bipolar amplifiers. This makes them better suited for interfacing with high-impedance sensors or low-level ac signals. They also feature inherently better ac response than bipolar or CMOS devices having comparable power consumption. The TLE206x family features a high-output-drive circuit capable of driving 100-Ω loads at supplies as low as ± 5 V. This makes them uniquely suited for driving transformer loads in modems and other applications requiring good ac characteristics, low power, and high output drive.

Because BiFET operational amplifiers are designed for use with dual power supplies, care must be taken to observe common-mode input voltage limits and output swing when operating from a single supply. DC biasing of the input signal is required and loads should be terminated to a virtual ground node at mid-supply. Texas Instruments TLE2426 integrated virtual ground generator is useful when operating BiFET amplifiers from single supplies.

The TLE206x are fully specified at ± 15 V and ± 5 V. For operation in low-voltage and/or single-supply systems, Texas Instruments LinCMOS families of operational amplifiers (TLC- and TLV-prefixes) are recommended. When moving from BiFET to CMOS amplifiers, particular attention should be paid to slew rate and bandwidth requirements and output loading. The Texas Instruments TLV2432 and TLV2442 CMOS operational amplifiers are excellent choices to consider.



Please be aware that an important notice concerning availability, standard warranty, and use in critical applications of Texas Instruments semiconductor products and disclaimers thereto appears at the end of this data sheet.

PRODUCTION DATA information is current as of publication date. Products conform to specifications per the terms of Texas Instruments standard warranty. Production processing does not necessarily include testing of all parameters.



POST OFFICE BOX 655303 • DALLAS, TEXAS 75265

Copyright © 2004, Texas Instruments Incorporated

TLE206x, TLE206xA, TLE206xB EXCALIBUR JFET-INPUT HIGH-OUTPUT-DRIVE μPOWER OPERATIONAL AMPLIFIERS

SLOS193B – FEBRUARY 1997 – REVISED MAY 2004

TLE2061 AVAILABLE OPTIONS

PACKAGED DEVICES							
T _A	V _{IO} max AT 25°C	SMALL OUTLINE† (D)	CHIP CARRIER (FK)	CERAMIC DIP (JG)	PLASTIC DIP (P)	TSSOP‡ (PW)	CERAMIC FLAT PACK (U)
0°C to 70°C	500 μV	—	—	—	—	—	—
	1.5 mV	TLE2061ACD	—	—	TLE2061ACP	—	—
	3 mV	TLE2061CD	—	—	TLE2061CP	TLE2061CPWLE	—
–40°C to 85°C	500 μV	—	—	—	—	—	—
	1.5 mV	TLE2061AID	—	—	TLE2061AIP	—	—
	3 mV	TLE2061ID	—	—	TLE2061IP	—	—
–55°C to 125°C	500 μV	—	—	TLE2061BMJG	—	—	—
	1.5 mV	TLE2061AMD	TLE2061AMFK	TLE2061AMJG	—	—	TLE2061AMU
	3 mV	TLE2061MD	TLE2061MFK	TLE2061MJG	—	—	TLE2061MU

† The D packages are available taped and reeled. Add R suffix to device type (e.g., TLE2061ACDR). Chips are tested at 25°C.

‡ The PW package is available left-end taped and reeled (indicated by the LE suffix on the device type (e.g., TLE2061CPWLE)).

TLE2062 AVAILABLE OPTIONS

PACKAGED DEVICES						
T _A	V _{IO} max AT 25°C	SMALL OUTLINE† (D)	CHIP CARRIER (FK)	CERAMIC DIP (JG)	PLASTIC DIP (P)	CERAMIC FLAT PACK (U)
0°C to 70°C	1 mV	TLE2062BCD	—	—	TLE2062BCP	—
	2 mV	TLE2062ACD	—	—	TLE2062ACP	—
	4 mV	TLE2062CD	—	—	TLE2062CP	—
–40°C to 85°C	1 mV	TLE2062BID	—	—	TLE2062BIP	—
	2 mV	TLE2062AID	—	—	TLE2062AIP	—
	4 mV	TLE2062ID	—	—	TLE2062IP	—
–55°C to 125°C	1 mV	TLE2062BMD	—	TLE2062BMJG	—	—
	2 mV	TLE2062AMD	TLE2062AMFK	TLE2062AMJG	—	TLE2062AMU
	4 mV	TLE2062MD	TLE2062MFK	TLE2062MJG	—	TLE2062MU

† The D packages are available taped and reeled. Add R suffix to device type (e.g., TLE2062ACDR).

TLE2064 AVAILABLE OPTIONS

PACKAGED DEVICES						
T _A	V _{IO} max AT 25°C	SMALL OUTLINE† (D)	CHIP CARRIER (FK)	CERAMIC DIP (J)	PLASTIC DIP (N)	CERAMIC FLAT PACK (W)
0°C to 70°C	2 mV	—	—	—	TLE2064BCN	—
	4 mV	TLE2064ACD	—	—	TLE2064ACN	—
	6 mV	TLE2064CD	—	—	TLE2064CN	—
–40°C to 85°C	2 mV	—	—	—	TLE2064BIN	—
	4 mV	TLE2064AID	—	—	TLE2064AIN	—
	6 mV	TLE2064ID	—	—	TLE2064IN	—
–55°C to 125°C	2 mV	—	TLE2064BMFK	TLE2064BMJ	—	—
	4 mV	TLE2064AMD	TLE2064AMFK	TLE2064AMJ	—	TLE2064AMW
	6 mV	TLE2064MD	TLE2064MFK	TLE2064MJ	—	TLE2064MW

† The D packages are available taped and reeled. Add R suffix to device type, (e.g., TLE2064ACDR).



TLE206x, TLE206xA, TLE206xB EXCALIBUR JFET-INPUT HIGH-OUTPUT-DRIVE μPOWER OPERATIONAL AMPLIFIERS

SLOS193B – FEBRUARY 1997 – REVISED MAY 2004

**TLE2061, TLE2061A, AND TLE2061B
D, DB, JG, P, OR PW PACKAGE
(TOP VIEW)**



**TLE2062, TLE2062A, TLE2062B
D, JG, OR P PACKAGE
(TOP VIEW)**



**TLE2064, TLE2064A, TLE2064B
D, J, N, OR W PACKAGE
(TOP VIEW)**

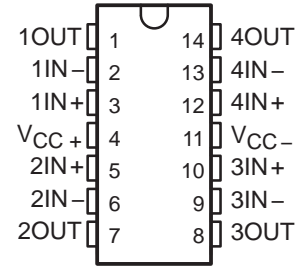

**TLE2061M, TLE2061AM, TLE2061BM
FK PACKAGE
(TOP VIEW)**



**TLE2062M, TLE2062AM, TLE2062BM
FK PACKAGE
(TOP VIEW)**



**TLE2064M, TLE2064AM, TLE2064BM
FK PACKAGE
(TOP VIEW)**

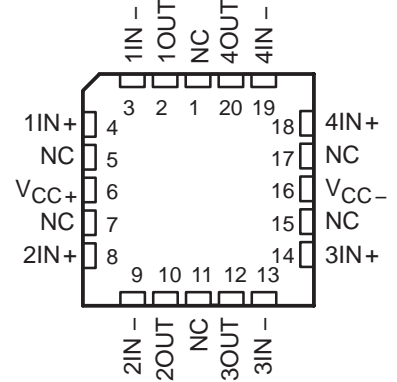

**TLE2061 AND TLE2061A
U PACKAGE
(TOP VIEW)**



**TLE2062 AND TLE2062A
U PACKAGE
(TOP VIEW)**



NC – No internal connection

TLE206x, TLE206xA, TLE206xB

EXCALIBUR JFET-INPUT HIGH-OUTPUT-DRIVE

POWER OPERATIONAL AMPLIFIERS

SLOS193B – FEBRUARY 1997 – REVISED APRIL 2004

equivalent schematic (each channel)

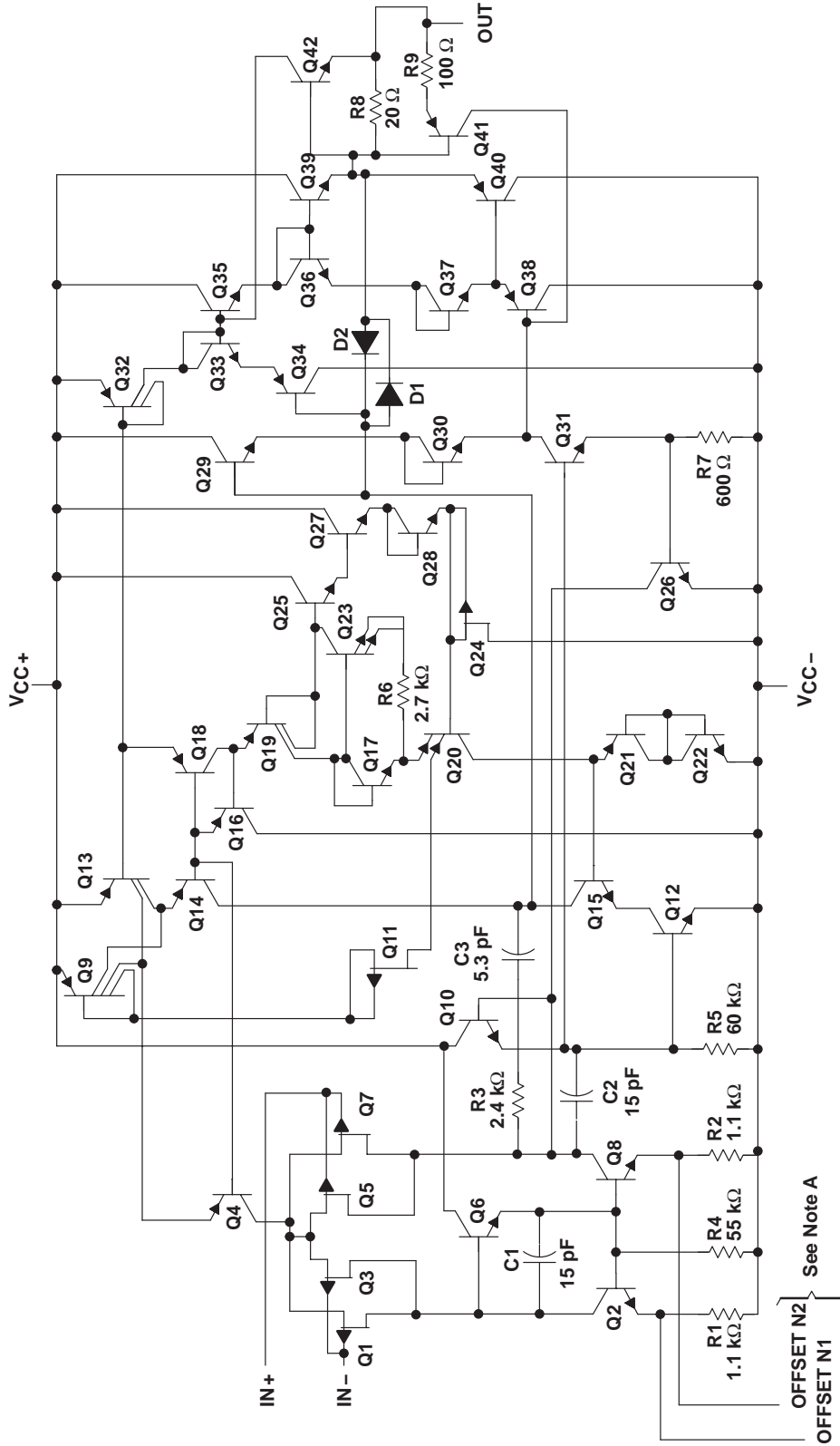

NOTES: A. OFFSET N1 AND OFFSET N2 are only available on the TLE2061x devices.
 B. Component values are nominal.

OFFSET N1 } See Note A
 OFFSET N2 }

COMPONENT	ACTUAL DEVICE COMPONENT COUNT		
	TLE2061	TLE2062	TLE2064
Transistors	43	42	42
Resistors	9	9	9
Diodes	1	2	2
Capacitors	3	3	3

absolute maximum ratings over operating free-air temperature range (unless otherwise noted)†

Supply voltage, V_{CC+} (see Note 1)	19 V
Supply voltage, V_{CC-}	–19 V
Differential input voltage, V_{ID} (see Note 2)	±38 V
Input voltage range, V_I (any input)	± V_{CC}
Input current, I_I (each input)	±1 mA
Output current, I_O	±80 mA
Total current into V_{CC+}	80 mA
Total current out of V_{CC-}	–80 mA
Duration of short-circuit current at (or below) 25°C (see Note 3)	unlimited
Package thermal impedance, θ_{JA} (see Notes 4 and 5):	
D package (8-pin)	97.1°C/W
D package (14-pin)	86.2°C/W
N package	79.7°C/W
P package	84.6°C/W
PW package	113°C/W
Package thermal impedance, θ_{JC} (see Notes 4 and 5):	
FK package	5.6°C/W
J package	15.1°C/W
JG package	14.5°C/W
U package	14.7°C/W
W package	10°C/W
Operating free-air temperature range, T_A :	
C suffix	0°C to 70°C
I suffix	–40°C to 85°C
M suffix	–55°C to 125°C
Storage temperature range	–65°C to 150°C
Case temperature for 60 seconds: FK package	260°C
Lead temperature 1,6 mm (1/16 inch) from case for 10 seconds: D, P, or PW package	260°C
Lead temperature 1,6 mm (1/16 inch) from case for 60 seconds: JG, U, or W package	300°C

† Stresses beyond those listed under “absolute maximum ratings” may cause permanent damage to the device. These are stress ratings only, and functional operation of the device at these or any other conditions beyond those indicated under “recommended operating conditions” is not implied. Exposure to absolute-maximum-rated conditions for extended periods may affect device reliability.

- NOTES:
1. All voltage values, except differential voltages, are with respect to the midpoint between V_{CC+} and V_{CC-} .
 2. Differential voltages are at $IN+$ with respect to $IN-$.
 3. The output may be shorted to either supply. Temperature and/or supply voltages must be limited to ensure that the maximum dissipation rating is not exceeded.
 4. Maximum power dissipation is a function of $T_J(max)$, θ_{JA} , and T_A . The maximum allowable power dissipation at any allowable ambient temperature is $P_D = (T_J(max) - T_A)/\theta_{JA}$. Operating at the absolute maximum T_J of 150°C can affect reliability.
 5. The package thermal impedance is calculated in accordance with JESD 51-7 (plastic) or MIL-STD-883 Method 1012 (ceramic).

recommended operating conditions

	C SUFFIX		I SUFFIX		M SUFFIX		UNIT
	MIN	MAX	MIN	MAX	MIN	MAX	
Supply voltage, $V_{CC\pm}$	±3.5	±18	±3.5	±18	±3.5	±18	V
Common-mode input voltage, V_{IC}	$V_{CC\pm} = \pm 5$ V		–1.6	4	–1.6	4	V
	$V_{CC\pm} = \pm 15$ V		–11	13	–11	13	
Operating free-air temperature, T_A	0	70	–40	85	–55	125	°C

TLE206x, TLE206xA, TLE206xB
EXCALIBUR JFET-INPUT HIGH-OUTPUT-DRIVE
μPOWER OPERATIONAL AMPLIFIERS

SLOS193B – FEBRUARY 1997 – REVISED MAY 2004

TLE2061C electrical characteristics at specified free-air temperature, $V_{CC\pm} = \pm 5\text{ V}$ (unless otherwise noted)

PARAMETER		TEST CONDITIONS	T_A †	TLE2061C TLE2061AC TLE2061BC			UNIT	
				MIN	TYP	MAX		
V_{IO} Input offset voltage	TLE2061C	$V_{IC} = 0, R_S = 50\ \Omega$	25°C	0.8	3.1	mV		
			Full range	4				
	TLE2061AC		25°C	0.6	2.6			
			Full range	3.5				
	TLE2061BC		25°C	0.5	1.9			
			Full range	2.4				
	α_{VIO} Temperature coefficient of input offset voltage			Full range	6		$\mu\text{V}/^\circ\text{C}$	
	Input offset voltage long-term drift (see Note 4)			25°C	0.04		$\mu\text{V}/\text{mo}$	
I_{IO} Input offset current		25°C	1		pA			
		Full range	0.8		nA			
I_{IB} Input bias current		25°C	3		pA			
		Full range	2		nA			
V_{ICR} Common-mode input voltage range		25°C	-1.6 to 4	-2 to 6	V			
		Full range	-1.6 to 4		V			
V_{OM+} Maximum positive peak output voltage swing	$R_L = 10\ \text{k}\Omega$	25°C	3.5	3.7	V			
		Full range	3.3					
	$R_L = 100\ \Omega$	25°C	2.5	3.1				
		Full range	2					
V_{OM-} Maximum negative peak output voltage swing	$R_L = 10\ \text{k}\Omega$	25°C	-3.7	-3.9	V			
		Full range	-3.3					
	$R_L = 100\ \Omega$	25°C	-2.5	-2.7				
		Full range	-2					
A_{VD} Large-signal differential voltage amplification	$V_O = \pm 2.8\ \text{V}, R_L = 10\ \text{k}\Omega$	25°C	15	80	V/mV			
		Full range	2					
	$V_O = 0\ \text{to}\ 2\ \text{V}, R_L = 100\ \Omega$	25°C	0.75	45				
		Full range	0.5					
	$V_O = 0\ \text{to}\ -2\ \text{V}, R_L = 100\ \Omega$	25°C	0.5	3				
		Full range	0.25					
r_i Input resistance		25°C	10^{12}		Ω			
c_i Input capacitance		25°C	4		pF			
z_o Open-loop output impedance	$I_O = 0$	25°C	280		Ω			
CMRR Common-mode rejection ratio	$V_{IC} = V_{ICR\text{min}}, R_S = 50\ \Omega$	25°C	65	82	dB			
		Full range	65					
k_{SVR} Supply-voltage rejection ratio ($\Delta V_{CC\pm}/\Delta V_{IO}$)	$V_{CC\pm} = \pm 5\ \text{V}\ \text{to}\ \pm 15\ \text{V}, R_S = 50\ \Omega$	25°C	75	93	dB			
		Full range	75					

† Full range is 0°C to 70°C.

NOTE 6: Typical values are based on the input offset voltage shift observed through 168 hours of operating life test at $T_A = 150^\circ\text{C}$ extrapolated to $T_A = 25^\circ\text{C}$ using the Arrhenius equation and assuming an activation energy of 0.96 eV.



TLE206x, TLE206xA, TLE206xB
EXCALIBUR JFET-INPUT HIGH-OUTPUT-DRIVE
μPOWER OPERATIONAL AMPLIFIERS

SLOS193B – FEBRUARY 1997 – REVISED MAY 2004

TLE2061C electrical characteristics at specified free-air temperature, $V_{CC\pm} = \pm 5\text{ V}$ (unless otherwise noted) (continued)

PARAMETER	TEST CONDITIONS	T_A †	TLE2061C TLE2061AC TLE2061BC			UNIT
			MIN	TYP	MAX	
I_{CC} Supply current	$V_O = 0$, No load	25°C		280	325	μA
		Full range			350	
ΔI_{CC} Supply-current change over operating temperature range		Full range		29		μA

† Full range is 0°C to 70°C.

TLE2061C operating characteristics at specified free-air temperature, $V_{CC\pm} = \pm 5\text{ V}$

PARAMETER	TEST CONDITIONS	T_A †	TLE2061C TLE2061AC TLE2061BC			UNIT
			MIN	TYP	MAX	
SR Slew rate at unity gain (see Figure 1)	$R_L = 10\text{ k}\Omega$, $C_L = 100\text{ pF}$	25°C	2.2	3.4		V/μs
		Full range	2.1			
V_n Equivalent input noise voltage (see Figure 2)	$f = 10\text{ Hz}$, $R_S = 20\ \Omega$	25°C		59	100	$\text{nV}/\sqrt{\text{Hz}}$
	$f = 1\text{ kHz}$, $R_S = 20\ \Omega$			43	60	
$V_{N(PP)}$ Peak-to-peak equivalent input noise voltage	$f = 0.1\text{ Hz}$ to 10 Hz	25°C		1.1		μV
I_n Equivalent input noise current	$f = 1\text{ kHz}$	25°C		1		$\text{fA}/\sqrt{\text{Hz}}$
THD Total harmonic distortion	$A_{VD} = 2$, $f = 10\text{ kHz}$, $V_{O(PP)} = 2\text{ V}$, $R_L = 10\text{ k}\Omega$	25°C		0.025%		
B_1 Unity-gain bandwidth (see Figure 3)	$R_L = 10\text{ k}\Omega$, $C_L = 100\text{ pF}$	25°C		1.8		MHz
	$R_L = 100\ \Omega$, $C_L = 100\text{ pF}$			1.3		
t_s Settling time	0.1%	25°C		5		μs
	0.01%			10		
B_{OM} Maximum output-swing bandwidth	$A_{VD} = 1$, $R_L = 10\text{ k}\Omega$	25°C		140		kHz
ϕ_m Phase margin at unity gain (see Figure 3)	$R_L = 10\text{ k}\Omega$, $C_L = 100\text{ pF}$	25°C		58°		
	$R_L = 100\ \Omega$, $C_L = 100\text{ pF}$			75°		

† Full range is 0°C to 70°C.



TLE206x, TLE206xA, TLE206xB
EXCALIBUR JFET-INPUT HIGH-OUTPUT-DRIVE
μPOWER OPERATIONAL AMPLIFIERS

SLOS193B – FEBRUARY 1997 – REVISED MAY 2004

TLE2061C electrical characteristics at specified free-air temperature, $V_{CC\pm} = \pm 15\text{ V}$ (unless otherwise noted)

PARAMETER		TEST CONDITIONS	T_A †	TLE2061C TLE2061AC TLE2061BC			UNIT	
				MIN	TYP	MAX		
V_{IO} Input offset voltage	TLE2061C	$V_{IC} = 0, R_S = 50\text{ k}\Omega$	25°C	0.6	3	mV		
			Full range	3.9				
			25°C	0.5	1.5			
	TLE2061AC		Full range	2.5				
	TLE2061BC		25°C	0.3	0.5			
			Full range	1				
			Full range	6			$\mu\text{V}/^\circ\text{C}$	
	αV_{IO} Temperature coefficient of input offset voltage			25°C	0.04			$\mu\text{V}/\text{mo}$
	Input offset voltage long-term drift (see Note 4)			25°C	2			pA
I_{IO} Input offset current		Full range	1		nA			
I_{IB} Input bias current		25°C	4		pA			
		Full range	3		nA			
V_{ICR} Common-mode input voltage range		25°C	-11 to 13	-12 to 16	V			
		Full range	-11 to 13		V			
V_{OM+} Maximum positive peak output voltage swing	$R_L = 10\text{ k}\Omega$	25°C	13.2	13.7	V			
		Full range	13					
	$R_L = 600\ \Omega$	25°C	12.5	13.2				
		Full range	12					
V_{OM-} Maximum negative peak output voltage swing	$R_L = 10\text{ k}\Omega$	25°C	-13.2	-13.7	V			
		Full range	-13					
	$R_L = 600\ \Omega$	25°C	-12.5	-13				
		Full range	-12					
A_{VD} Large-signal differential voltage amplification	$V_O = \pm 10\text{ V}, R_L = 10\text{ k}\Omega$	25°C	30	230	V/mV			
		Full range	20					
	$V_O = 0\text{ to }8\text{ V}, R_L = 600\ \Omega$	25°C	25	100				
		Full range	10					
	$V_O = 0\text{ to }-8\text{ V}, R_L = 600\ \Omega$	25°C	3	25				
		Full range	1					
r_i Input resistance		25°C	10^{12}		Ω			
c_i Input capacitance		25°C	4		pF			
z_o Open-loop output impedance	$I_O = 0$	25°C	280		Ω			
CMRR Common-mode rejection ratio	$V_{IC} = V_{ICRmin}, R_S = 50\ \Omega$	25°C	72	90	dB			
		Full range	70					
k_{SVR} Supply-voltage rejection ratio ($\Delta V_{CC\pm}/\Delta V_{IO}$)	$V_{CC\pm} = \pm 5\text{ V to } \pm 15\text{ V}, R_S = 50\ \Omega$	25°C	75	93	dB			
		Full range	75					

† Full range is 0°C to 70°C.

NOTE 4: Typical values are based on the input offset voltage shift observed through 168 hours of operating life test at $T_A = 150^\circ\text{C}$ extrapolated to $T_A = 25^\circ\text{C}$ using the Arrhenius equation and assuming an activation energy of 0.96 eV.



TLE206x, TLE206xA, TLE206xB
EXCALIBUR JFET-INPUT HIGH-OUTPUT-DRIVE
μPOWER OPERATIONAL AMPLIFIERS

SLOS193B – FEBRUARY 1997 – REVISED MAY 2004

TLE2061C electrical characteristics at specified free-air temperature, $V_{CC\pm} = \pm 15\text{ V}$ (unless otherwise noted) (continued)

PARAMETER	TEST CONDITIONS	T_A †	TLE2061C TLE2061AC TLE2061BC			UNIT
			MIN	TYP	MAX	
I_{CC} Supply current	$V_O = 0$, No load	25°C	290	350	μA	
		Full range	375			
ΔI_{CC} Supply-current change over operating temperature range		Full range	34		μA	

† Full range is 0°C to 70°C.

TLE2061C operating characteristics at specified free-air temperature, $V_{CC\pm} = \pm 15\text{ V}$

PARAMETER	TEST CONDITIONS	T_A †	TLE2061C TLE2061AC TLE2061BC			UNIT
			MIN	TYP	MAX	
SR Slew rate at unity gain (see Figure 1)	$R_L = 10\text{ k}\Omega$, $C_L = 100\text{ pF}$	25°C	2.6	3.4	V/μs	
		Full range	2.5			
V_n Equivalent input noise voltage (see Figure 2)	$f = 10\text{ Hz}$, $R_S = 20\ \Omega$	25°C	70	100	nV/√Hz	
	$f = 1\text{ kHz}$, $R_S = 20\ \Omega$		40	60		
$V_{N(PP)}$ Peak-to-peak equivalent input noise voltage	$f = 0.1\text{ Hz to }10\text{ Hz}$	25°C	1.1		μV	
I_n Equivalent input noise current	$f = 1\text{ kHz}$	25°C	1.1		fA/√Hz	
THD Total harmonic distortion	$A_{VD} = 2$, $f = 10\text{ kHz}$, $V_{O(PP)} = 2\text{ V}$, $R_L = 10\text{ k}\Omega$	25°C	0.025%			
B_1 Unity-gain bandwidth (see Figure 3)	$R_L = 10\text{ k}\Omega$, $C_L = 100\text{ pF}$	25°C	2		MHz	
	$R_L = 600\ \Omega$, $C_L = 100\text{ pF}$		1.5			
t_s Settling time	0.1%	25°C	5		μs	
	0.01%		10			
B_{OM} Maximum output-swing bandwidth	$A_{VD} = 1$, $R_L = 10\text{ k}\Omega$	25°C	40		kHz	
ϕ_m Phase margin at unity gain (see Figure 3)	$R_L = 10\text{ k}\Omega$, $C_L = 100\text{ pF}$	25°C	60°			
	$R_L = 600\ \Omega$, $C_L = 100\text{ pF}$		70°			

† Full range is 0°C to 70°C.

TLE206x, TLE206xA, TLE206xB
EXCALIBUR JFET-INPUT HIGH-OUTPUT-DRIVE
μPOWER OPERATIONAL AMPLIFIERS

SLOS193B – FEBRUARY 1997 – REVISED MAY 2004

TLE2061I electrical characteristics at specified free-air temperature, $V_{CC\pm} = \pm 5\text{ V}$ (unless otherwise noted)

PARAMETER		TEST CONDITIONS	T_A †	TLE2061I, TLE2061AI TLE2061BI			UNIT		
				MIN	TYP	MAX			
V_{IO}	Input offset voltage	$V_{IC} = 0,$ $R_S = 50\ \Omega$	25°C	0.8	3.1	mV			
			Full range		4.4				
			25°C	0.6	2.6				
			Full range		3.9				
			25°C	0.5	1.9				
			Full range		2.7				
			α_{VIO}	Temperature coefficient of input offset voltage	Full range		6		$\mu\text{V}/^\circ\text{C}$
				Input offset voltage long-term drift (see Note 4)	25°C		0.04		$\mu\text{V}/\text{mo}$
					25°C		1		pA
I_{IO}	Input offset current	Full range		2	nA				
I_{IB}	Input bias current	25°C	3		pA				
		Full range		4	nA				
V_{ICR}	Common-mode input voltage range		25°C	-1.6 to 4	-2 to 6	V			
			Full range	-1.6 to 4		V			
V_{OM+}	Maximum positive peak output voltage swing	$R_L = 10\ \text{k}\Omega$	25°C	3.5	3.7	V			
			Full range		3.1				
			25°C	2.5	3.1				
			Full range		2				
V_{OM-}	Maximum negative peak output voltage swing	$R_L = 10\ \text{k}\Omega$	25°C	-3.7	-3.9	V			
			Full range		-3.1				
			25°C	-2.5	-2.7				
			Full range		-2				
A_{VD}	Large-signal differential voltage amplification	$V_O = \pm 2.8\ \text{V},$ $R_L = 10\ \text{k}\Omega$	25°C	15	80	V/mV			
			Full range		2				
			25°C	0.75	45				
			Full range		0.5				
			25°C	0.5	3				
			Full range		0.25				
r_i	Input resistance		25°C	10^{12}		Ω			
c_i	Input capacitance		25°C	4		pF			
z_o	Open-loop output impedance	$I_O = 0$	25°C	280		Ω			
CMRR	Common-mode rejection ratio	$V_{IC} = V_{ICR\text{min}},$ $R_S = 50\ \Omega$	25°C	65	82	dB			
			Full range		65				
kSVR	Supply-voltage rejection ratio ($\Delta V_{CC\pm}/\Delta V_{IO}$)	$V_{CC\pm} = \pm 5\ \text{V to } \pm 15\ \text{V},$ $R_S = 50\ \Omega$	25°C	75	93	dB			
			Full range		65				
I_{CC}	Supply current	$V_O = 0,$ No load	25°C	280	325	μA			
			Full range		350				
ΔI_{CC}	Supply-current change over operating temperature range		Full range	29		μA			

† Full range is -40°C to 85°C.

NOTE 4: Typical values are based on the input offset voltage shift observed through 168 hours of operating life test at $T_A = 150^\circ\text{C}$ extrapolated to $T_A = 25^\circ\text{C}$ using the Arrhenius equation and assuming an activation energy of 0.96 eV.



TLE206x, TLE206xA, TLE206xB
EXCALIBUR JFET-INPUT HIGH-OUTPUT-DRIVE
μPOWER OPERATIONAL AMPLIFIERS

SLOS193B – FEBRUARY 1997 – REVISED MAY 2004

TLE20611 operating characteristics at specified free-air temperature, $V_{CC\pm} = \pm 5\text{ V}$

PARAMETER	TEST CONDITIONS	T_A †	TLE20611 TLE2061AI TLE2061BI			UNIT
			MIN	TYP	MAX	
SR Slew rate at unity gain (see Figure 1)	$R_L = 10\text{ k}\Omega$, $C_L = 100\text{ pF}$	25°C	2.2	3.4		V/ μs
		Full range	1.7			
V_n Equivalent input noise voltage (see Figure 2)	$f = 10\text{ Hz}$, $R_S = 20\ \Omega$	25°C		59	100	nV/ $\sqrt{\text{Hz}}$
	$f = 1\text{ kHz}$, $R_S = 20\ \Omega$			43	60	
$V_{N(PP)}$ Peak-to-peak equivalent input noise voltage	$f = 0.1\text{ Hz to }10\text{ Hz}$	25°C	1.1		μV	
I_n Equivalent input noise current	$f = 1\text{ kHz}$	25°C	1		fA/ $\sqrt{\text{Hz}}$	
THD Total harmonic distortion	$A_{VD} = 2$, $f = 10\text{ kHz}$, $V_{O(PP)} = 2\text{ V}$, $R_L = 10\text{ k}\Omega$	25°C	0.025%			
B_1 Unity-gain bandwidth (see Figure 3)	$R_L = 10\text{ k}\Omega$, $C_L = 100\text{ pF}$	25°C	1.8		MHz	
	$R_L = 100\ \Omega$, $C_L = 100\text{ pF}$		1.3			
t_s Settling time	0.1%	25°C	5		μs	
	0.01%		10			
B_{OM} Maximum output-swing bandwidth	$A_{VD} = 1$, $R_L = 10\text{ k}\Omega$	25°C	140		kHz	
ϕ_m Phase margin at unity gain (see Figure 3)	$R_L = 10\text{ k}\Omega$, $C_L = 100\text{ pF}$	25°C	58°			
	$R_L = 100\ \Omega$, $C_L = 100\text{ pF}$		75°			

† Full range is -40°C to 85°C .

TLE206x, TLE206xA, TLE206xB
EXCALIBUR JFET-INPUT HIGH-OUTPUT-DRIVE
μPOWER OPERATIONAL AMPLIFIERS

SLOS193B – FEBRUARY 1997 – REVISED MAY 2004

TLE2061I electrical characteristics at specified free-air temperature, $V_{CC\pm} = \pm 15\text{ V}$ (unless otherwise noted)

PARAMETER		TEST CONDITIONS	T_A †	TLE2061I, TLE2061AI TLE2061BI			UNIT
				MIN	TYP	MAX	
V_{IO}	Input offset voltage		25°C	TLE2061I		0.6	3
				TLE2061AI		4.3	
				TLE2061BI		0.5	1.5
						2.9	
						0.3	0.5
						1.3	
α_{VIO}	Temperature coefficient of input offset voltage	$V_{IC} = 0$, $R_S = 50\ \Omega$	Full range	6		$\mu\text{V}/^\circ\text{C}$	
	Input offset voltage long-term drift (see Note 4)			25°C	0.04		$\mu\text{V}/\text{mo}$
I_{IO}	Input offset current			25°C	2		pA
				Full range	3		nA
I_{IB}	Input bias current			25°C	4		pA
				Full range	5		nA
V_{ICR}	Common-mode input voltage range	25°C	-11 to 13	-12 to 16	V		
		Full range	-11 to 13		V		
V_{OM+}	Maximum positive peak output voltage swing	$R_L = 10\ \text{k}\Omega$	25°C	13.2	13.7	V	
			Full range	13			
		$R_L = 600\ \Omega$	25°C	12.5	13.2		
			Full range	12			
V_{OM-}	Maximum negative peak output voltage swing	$R_L = 10\ \text{k}\Omega$	25°C	-13.2	-13.7	V	
			Full range	-13			
		$R_L = 600\ \Omega$	25°C	-12.5	-13		
			Full range	-12			
A_{VD}	Large-signal differential voltage amplification	$V_O = \pm 10\ \text{V}$, $R_L = 10\ \text{k}\Omega$	25°C	30	230	V/mV	
			Full range	20			
		$V_O = 0\ \text{to}\ 8\ \text{V}$, $R_L = 600\ \Omega$	25°C	25	100		
			Full range	10			
		$V_O = 0\ \text{to}\ -8\ \text{V}$, $R_L = 600\ \Omega$	25°C	3	25		
			Full range	01			
r_i	Input resistance		25°C	10^{12}		Ω	
c_i	Input capacitance		25°C	4		pF	
z_o	Open-loop output impedance	$I_O = 0$	25°C	280		Ω	
CMRR	Common-mode rejection ratio	$V_{IC} = V_{ICR\text{min}}$, $R_S = 50\ \Omega$	25°C	72	90	dB	
			Full range	65			
k_{SVR}	Supply-voltage rejection ratio ($\Delta V_{CC\pm}/\Delta V_{IO}$)	$V_{CC\pm} = \pm 5\ \text{V to } \pm 15\ \text{V}$, $R_S = 50\ \Omega$	25°C	75	93	dB	
			Full range	65			
I_{CC}	Supply current	$V_O = 0$, No load	25°C	290	350	μA	
			Full range	375			
ΔI_{CC}	Supply-current change over operating temperature range		Full range	34		μA	

† Full range is -40°C to 85°C.

NOTE 4: Typical values are based on the input offset voltage shift observed through 168 hours of operating life test at $T_A = 150^\circ\text{C}$ extrapolated to $T_A = 25^\circ\text{C}$ using the Arrhenius equation and assuming an activation energy of 0.96 eV.



TLE206x, TLE206xA, TLE206xB
EXCALIBUR JFET-INPUT HIGH-OUTPUT-DRIVE
μPOWER OPERATIONAL AMPLIFIERS

SLOS193B – FEBRUARY 1997 – REVISED MAY 2004

TLE2061I operating characteristics at specified free-air temperature, $V_{CC\pm} = \pm 15\text{ V}$

PARAMETER	TEST CONDITIONS	T_A †	TLE2061I TLE2061AI TLE2061BI			UNIT
			MIN	TYP	MAX	
SR Slew rate at unity gain (see Figure 1)	$R_L = 10\text{ k}\Omega$, $C_L = 100\text{ pF}$	25°C	2.6	3.4		V/ μ s
		Full range	2.1			
V_n Equivalent input noise voltage (see Figure 2)	$f = 10\text{ Hz}$, $R_S = 20\ \Omega$	25°C		70	100	nV/ $\sqrt{\text{Hz}}$
	$f = 1\text{ kHz}$, $R_S = 20\ \Omega$			40	60	
$V_{N(PP)}$ Peak-to-peak equivalent input noise voltage	$f = 0.1\text{ Hz to }10\text{ Hz}$	25°C		1.1		μ V
I_n Equivalent input noise current	$f = 1\text{ kHz}$	25°C		1.1		fA/ $\sqrt{\text{Hz}}$
THD Total harmonic distortion	$A_{VD} = 2$, $f = 10\text{ kHz}$, $V_{O(PP)} = 2\text{ V}$, $R_L = 10\text{ k}\Omega$	25°C		0.025%		
B_1 Unity-gain bandwidth (see Figure 3)	$R_L = 10\text{ k}\Omega$, $C_L = 100\text{ pF}$	25°C		2		MHz
	$R_L = 600\ \Omega$, $C_L = 100\text{ pF}$			1.5		
t_s Settling time	0.1%	25°C		5		μ s
	0.01%			10		
B_{OM} Maximum output-swing bandwidth	$A_{VD} = 1$, $R_L = 10\text{ k}\Omega$	25°C		40		kHz
ϕ_m Phase margin at unity gain (see Figure 3)	$R_L = 10\text{ k}\Omega$, $C_L = 100\text{ pF}$	25°C		60°		
	$R_L = 600\ \Omega$, $C_L = 100\text{ pF}$			70°		

† Full range is -40°C to 85°C .

TLE206x, TLE206xA, TLE206xB
EXCALIBUR JFET-INPUT HIGH-OUTPUT-DRIVE
μPOWER OPERATIONAL AMPLIFIERS

SLOS193B – FEBRUARY 1997 – REVISED MAY 2004

TLE2061M electrical characteristics at specified free-air temperature, $V_{CC\pm} = \pm 5\text{ V}$ (unless otherwise noted)

PARAMETER		TEST CONDITIONS	T_A †	TLE2061M TLE2061AM TLE2061BM			UNIT		
				MIN	TYP	MAX			
V_{IO}	Input offset voltage	$V_{IC} = 0, R_S = 50\ \Omega$	25°C	0.8	3.1	mV			
			Full range	6					
			25°C	0.6	2.6				
			Full range	4.6					
			25°C	0.5	1.9				
			Full range	3.1					
			α_{VIO}	Temperature coefficient of input offset voltage	Full range		6		$\mu\text{V}/^\circ\text{C}$
				Input offset voltage long-term drift (see Note 4)	25°C		0.04		$\mu\text{V}/\text{mo}$
			I_{IO}	Input offset current	25°C		1		pA
		Full range	15		nA				
I_{IB}	Input bias current	25°C	3		pA				
		Full range	30		nA				
V_{ICR}	Common-mode input voltage range		25°C	-1.6 to 4	-2 to 6	V			
			Full range	-1.6 to 4		V			
V_{OM+}	Maximum positive peak output voltage swing	$R_L = 10\ \text{k}\Omega$	25°C	3.5	3.7	V			
			Full range	3					
			25°C	2.5	3.6				
			Full range	2					
			25°C	2.5	3.1				
			Full range	2					
V_{OM-}	Maximum negative peak output voltage swing	$R_L = 10\ \text{k}\Omega$	25°C	-3.5	-3.9	V			
			Full range	-3					
		FK and JG packages	$R_L = 600\ \Omega$	25°C	-2.5		-3.5		
				Full range	-2				
		D and P packages	$R_L = 100\ \Omega$	25°C	-2.5		-2.7		
				Full range	-2				
AVD	Large-signal differential voltage amplification		25°C	15	80	V/mV			
							Full range	2	
			FK and JG packages	$V_O = 0\ \text{to}\ 2.5\ \text{V}, R_L = 600\ \Omega$	25°C		1	65	
					Full range		0.5		
			FK and JG packages	$V_O = 0\ \text{to}\ -2.5\ \text{V}, R_L = 600\ \Omega$	25°C		1	16	
					Full range		0.5		
			D and P packages	$V_O = 0\ \text{to}\ 2\ \text{V}, R_L = 100\ \Omega$	25°C		0.75	45	
					Full range		0.5		
			D and P packages	$V_O = 0\ \text{to}\ -2\ \text{V}, R_L = 100\ \Omega$	25°C		0.5	3	
					Full range		0.25		

† Full range is -55°C to 125°C .

NOTE 4: Typical values are based on the input offset voltage shift observed through 168 hours of operating life test at $T_A = 150^\circ\text{C}$ extrapolated to $T_A = 25^\circ\text{C}$ using the Arrhenius equation and assuming an activation energy of 0.96 eV.



TLE206x, TLE206xA, TLE206xB
EXCALIBUR JFET-INPUT HIGH-OUTPUT-DRIVE
μPOWER OPERATIONAL AMPLIFIERS

SLOS193B – FEBRUARY 1997 – REVISED MAY 2004

TLE2061M electrical characteristics at specified free-air temperature, $V_{CC\pm} = \pm 5\text{ V}$ (unless otherwise noted) (continued)

PARAMETER	TEST CONDITIONS	T_A †	TLE2061M TLE2061AM TLE2061BM			UNIT
			MIN	TYP	MAX	
r_i Input resistance		25°C	10 ¹²			Ω
c_i Input capacitance		25°C	4			pF
z_o Open-loop output impedance	$I_O = 0$	25°C	280			Ω
CMRR Common-mode rejection ratio	$V_{IC} = V_{ICRmin}$, $R_S = 50\ \Omega$	25°C	65	82		dB
		Full range	60			
k_{SVR} Supply-voltage rejection ratio ($\Delta V_{CC\pm}/\Delta V_{IO}$)	$V_{CC\pm} = \pm 5\text{ V to } \pm 15\text{ V}$, $R_S = 50\ \Omega$	25°C	75	93		dB
		Full range	65			
I_{CC} Supply current	$V_O = 0$, No load	25°C	280	325		μA
		Full range		350		
ΔI_{CC} Supply-current change over operating temperature range		Full range	39			μA

† Full range is –55°C to 125°C.

TLE2061M operating characteristics at specified free-air temperature, $V_{CC\pm} = \pm 5\text{ V}$, $T_A = 25^\circ\text{C}$

PARAMETER	TEST CONDITIONS	TLE2061M TLE2061AM TLE2061BM			UNIT
		MIN	TYP	MAX	
SR Slew rate at unity gain (see Figure 1)	$R_L = 10\text{ k}\Omega$, $C_L = 100\text{ pF}$	3.4			V/μs
V_n Equivalent input noise voltage (see Figure 2)	$f = 10\text{ Hz}$, $R_S = 20\ \Omega$	59			$nV/\sqrt{\text{Hz}}$
	$f = 1\text{ kHz}$, $R_S = 20\ \Omega$	43			
$V_{N(PP)}$ Peak-to-peak equivalent input noise voltage	$f = 0.1\text{ Hz to } 10\text{ Hz}$	1.1			μV
I_n Equivalent input noise current	$f = 1\text{ kHz}$	1			fA/ $\sqrt{\text{Hz}}$
THD Total harmonic distortion	$A_{VD} = 2$, $f = 10\text{ kHz}$, $V_{O(PP)} = 2\text{ V}$, $R_L = 10\text{ k}\Omega$	0.025%			
B_1 Unity-gain bandwidth (see Figure 3)	$R_L = 10\text{ k}\Omega$, $C_L = 100\text{ pF}$	1.8			MHz
	$R_L = 600\ \Omega$, $C_L = 100\text{ pF}$	1.3			
t_s Settling time	0.1%	5			μs
	0.01%	10			
B_{OM} Maximum output-swing bandwidth	$A_{VD} = 1$, $R_L = 10\text{ k}\Omega$	140			kHz
ϕ_m Phase margin at unity gain (see Figure 3)	$R_L = 10\text{ k}\Omega$, $C_L = 100\text{ pF}$	58°			
	$R_L = 600\ \Omega$, $C_L = 100\text{ pF}$	75°			

TLE206x, TLE206xA, TLE206xB EXCALIBUR JFET-INPUT HIGH-OUTPUT-DRIVE μPOWER OPERATIONAL AMPLIFIERS

SLOS193B – FEBRUARY 1997 – REVISED MAY 2004

TLE2061M electrical characteristics at specified free-air temperature, $V_{CC\pm} = \pm 15\text{ V}$ (unless otherwise noted)

PARAMETER		TEST CONDITIONS	T_A †	TLE2061M ,TLE2061AM TLE2061BM			UNIT		
				MIN	TYP	MAX			
V_{IO}	Input offset voltage		25°C	0.6		3	mV		
				Full range		6			
			TLE2061M		25°C	0.5		1.5	
						Full range		3.6	
			TLE2061AM		25°C	0.3		0.5	
						Full range		1.7	
α_{VIO}	Temperature coefficient of input offset voltage	$V_{IC} = 0,$ $R_S = 50\ \Omega$	Full range	6		$\mu\text{V}/^\circ\text{C}$			
	Input offset voltage long-term drift (see Note 4)		25°C	0.04		$\mu\text{V}/\text{mo}$			
I_{IO}	Input offset current		25°C	2		pA			
			Full range		20	nA			
I_{IB}	Input bias current		25°C	4		pA			
			Full range		40	nA			
V_{ICR}	Common-mode input voltage range		25°C	-11 to 13	-12 to 16	V			
		Full range		-11 to 13		V			
V_{OM+}	Maximum positive peak output voltage swing	$R_L = 10\ \text{k}\Omega$	25°C	13	13.7	V			
			Full range		12.5				
		$R_L = 600\ \Omega$	25°C	12.5	13.2				
			Full range		12				
V_{OM-}	Maximum negative peak output voltage swing	$R_L = 10\ \text{k}\Omega$	25°C	-13	-13.7	V			
			Full range		-12.5				
		$R_L = 600\ \Omega$	25°C	-12.5	-13				
			Full range		-12				
A_{VD}	Large-signal differential voltage amplification	$V_O = \pm 10\ \text{V},$ $R_L = 10\ \text{k}\Omega$	25°C	30	230	V/mV			
			Full range		20				
		$V_O = 0\ \text{to}\ 8\ \text{V},$ $R_L = 600\ \Omega$	25°C	25	100				
			Full range		7				
		$V_O = 0\ \text{to}\ -8\ \text{V},$ $R_L = 600\ \Omega$	25°C	3	25				
			Full range		1				
r_i	Input resistance		25°C	10^{12}		Ω			
c_i	Input capacitance		25°C	4		pF			
z_o	Open-loop output impedance	$I_O = 0$	25°C	280		Ω			
CMRR	Common-mode rejection ratio	$V_{IC} = V_{ICR\text{min}},$ $R_S = 50\ \Omega$	25°C	72	90	dB			
			Full range		65				
k_{SVR}	Supply-voltage rejection ratio ($\Delta V_{CC\pm}/\Delta V_{IO}$)	$V_{CC\pm} = \pm 5\ \text{V}\ \text{to}\ \pm 15\ \text{V},$ $R_S = 50\ \Omega$	25°C	75	93	dB			
			Full range		65				

† Full range is -55°C to 125°C .

NOTE 4: Typical values are based on the input offset voltage shift observed through 168 hours of operating life test at $T_A = 150^\circ\text{C}$ extrapolated to $T_A = 25^\circ\text{C}$ using the Arrhenius equation and assuming an activation energy of 0.96 eV.



TLE206x, TLE206xA, TLE206xB
EXCALIBUR JFET-INPUT HIGH-OUTPUT-DRIVE
μPOWER OPERATIONAL AMPLIFIERS

SLOS193B – FEBRUARY 1997 – REVISED MAY 2004

TLE2061M electrical characteristics at specified free-air temperature, $V_{CC\pm} = \pm 15\text{ V}$ (unless otherwise noted) (continue)

PARAMETER	TEST CONDITIONS	T_A †	TLE2061M ,TLE2061AM TLE2061BM			UNIT
			MIN	TYP	MAX	
I_{CC} Supply current	$V_O = 0$, No load	25°C		290	350	μA
		Full range			375	
ΔI_{CC} Supply-current change over operating temperature range		Full range		46		μA

† Full range is -55°C to 125°C .

TLE2061M operating characteristics at specified free-air temperature, $V_{CC\pm} = \pm 15\text{ V}$

PARAMETER	TEST CONDITIONS	T_A †	TLE2061M TLE2061AM TLE2061BM			UNIT
			MIN	TYP	MAX	
SR Slew rate at unity gain (see Figure 1)	$R_L = 10\text{ k}\Omega$, $C_L = 100\text{ pF}$	25°C	2	3.4		V/μs
		Full range	1.8			
V_n Equivalent input noise voltage (see Figure 2)	$f = 10\text{ Hz}$, $R_S = 20\ \Omega$	25°C		70		$\text{nV}/\sqrt{\text{Hz}}$
	$f = 1\text{ kHz}$, $R_S = 20\ \Omega$	25°C		40		
$V_{N(PP)}$ Peak-to-peak equivalent input noise voltage	$f = 0.1\text{ Hz}$ to 10 Hz	25°C		1.1		μV
I_n Equivalent input noise current	$f = 1\text{ kHz}$	25°C		1.1		$\text{fA}/\sqrt{\text{Hz}}$
THD Total harmonic distortion	$A_{VD} = 2$, $f = 10\text{ kHz}$, $V_{O(PP)} = 2\text{ V}$, $R_L = 10\text{ k}\Omega$	25°C		0.025%		
B_1 Unity-gain bandwidth (see Figure 3)	$R_L = 10\text{ k}\Omega$, $C_L = 100\text{ pF}$	25°C		2		MHz
	$R_L = 600\ \Omega$, $C_L = 100\text{ pF}$	25°C		1.5		
t_s Settling time	0.1%	25°C		5		μs
	0.01%	25°C		10		
B_{OM} Maximum output-swing bandwidth	$A_{VD} = 1$, $R_L = 10\text{ k}\Omega$	25°C		40		kHz
ϕ_m Phase margin at unity gain (see Figure 3)	$R_L = 10\text{ k}\Omega$, $C_L = 100\text{ pF}$	25°C		60°		
	$R_L = 600\ \Omega$, $C_L = 100\text{ pF}$	25°C		70°		

† Full range is -55°C to 125°C .



TLE206x, TLE206xA, TLE206xB EXCALIBUR JFET-INPUT HIGH-OUTPUT-DRIVE μPOWER OPERATIONAL AMPLIFIERS

SLOS193B – FEBRUARY 1997 – REVISED MAY 2004

TLE2061Y electrical characteristics at $V_{CC\pm} = \pm 15\text{ V}$, $T_A = 25^\circ\text{C}$ (unless otherwise noted)

PARAMETER	TEST CONDITIONS	TLE2061Y			UNIT
		MIN	TYP	MAX	
V_{IO} Input offset voltage	$V_{IC} = 0$, $R_S = 50\ \Omega$		0.6	3	mV
αV_{IO} Input offset voltage long-term drift (see Note 4)			0.04		$\mu\text{V}/\text{mo}$
I_{IO} Input offset current			2		pA
I_{IB} Input bias current			4		pA
V_{ICR} Common-mode input voltage range		-11 to 13	-12 to 16		V
V_{OM+} Maximum positive peak output voltage swing	$R_L = 10\ \text{k}\Omega$	13.2	13.7		V
	$R_L = 600\ \Omega$	12.5	13.2		
V_{OM-} Maximum negative peak output voltage swing	$R_L = 10\ \text{k}\Omega$	-13.2	-13.7		V
	$R_L = 600\ \Omega$	-12.5	-13		
A_{VD} Large-signal differential voltage amplification	$V_O = \pm 10\ \text{V}$, $R_L = 10\ \text{k}\Omega$	30	230		V/mV
	$V_O = 0\ \text{to}\ 8\ \text{V}$, $R_L = 600\ \Omega$	25	100		
	$V_O = 0\ \text{to}\ -8\ \text{V}$, $R_L = 600\ \Omega$	3	25		
r_i Input resistance			10^{12}		Ω
c_i Input capacitance			4		pF
z_o Open-loop output impedance	$I_O = 0$		280		Ω
CMRR Common-mode rejection ratio	$R_S = 50\ \Omega$, $V_{IC} = V_{ICR\text{min}}$	72	90		dB
k_{SVR} Supply-voltage rejection ratio ($\Delta V_{CC}/\Delta V_{IO}$)	$V_{CC\pm} = \pm 5\ \text{V}\ \text{to}\ \pm 15\ \text{V}$, $R_S = 50\ \Omega$	75	93		dB
I_{CC} Supply current	$V_O = 0$, No load		290	350	μA

NOTE 4: Typical values are based on the input offset voltage shift observed through 168 hours of operating life test at $T_A = 150^\circ\text{C}$ extrapolated to $T_A = 25^\circ\text{C}$ using the Arrhenius equation and assuming an activation energy of 0.96 eV.

TLE2061Y operating characteristics at $V_{CC\pm} = \pm 15\ \text{V}$, $T_A = 25^\circ\text{C}$

PARAMETER	TEST CONDITIONS	TLE2061Y			UNIT
		MIN	TYP	MAX	
SR Slew rate at unity gain (see Figure 1)	$R_L = 10\ \text{k}\Omega$, $C_L = 100\ \text{pF}$	2.6	3.4		V/ μs
V_n Equivalent input noise voltage (see Figure 2)	$f = 10\ \text{Hz}$, $R_S = 20\ \Omega$		70		nV/ $\sqrt{\text{Hz}}$
	$f = 1\ \text{kHz}$, $R_S = 20\ \Omega$		40		
$V_{N(PP)}$ Peak-to-peak equivalent input noise voltage	$f = 0.1\ \text{Hz}\ \text{to}\ 10\ \text{Hz}$		1.1		μV
I_n Equivalent input noise current	$f = 1\ \text{Hz}$		1.1		fA/ $\sqrt{\text{Hz}}$
THD Total harmonic distortion	$A_{VD} = 2$, $f = 10\ \text{kHz}$, $V_{O(PP)} = 2\ \text{V}$, $R_L = 10\ \text{k}\Omega$		0.025%		
B_1 Unity-gain bandwidth (see Figure 3)	$R_L = 10\ \text{k}\Omega$, $C_L = 100\ \text{pF}$		2		MHz
	$R_L = 600\ \Omega$, $C_L = 100\ \text{pF}$		1.5		
t_s Settling time	0.1%		5		μs
	0.01%		10		
BOM Maximum output-swing bandwidth	$A_{VD} = 1$, $R_L = 10\ \text{k}\Omega$		40		kHz
ϕ_m Phase margin at unity gain (see Figure 3)	$R_L = 10\ \text{k}\Omega$, $C_L = 100\ \text{pF}$		60°		
	$R_L = 600\ \Omega$, $C_L = 100\ \text{pF}$		70°		



TLE206x, TLE206xA, TLE206xB
EXCALIBUR JFET-INPUT HIGH-OUTPUT-DRIVE
μPOWER OPERATIONAL AMPLIFIERS

SLOS193B – FEBRUARY 1997 – REVISED MAY 2004

TLE2062C electrical characteristics at specified free-air temperature, $V_{CC\pm} = \pm 5\text{ V}$ (unless otherwise noted)

PARAMETER		TEST CONDITIONS	T_A^\dagger	TLE2062C TLE2062AC TLE2062BC			UNIT
				MIN	TYP	MAX	
V_{IO}	Input offset voltage	$V_{IC} = 0,$ $R_S = 50\ \Omega$	25°C	1	5	mV	
			Full range	5.9			
			25°C	0.9	4		
			Full range	4.9			
			25°C	0.7	3		
			Full range	3.9			
α_{VIO}	Temperature coefficient of input offset voltage	$V_{IC} = 0,$ $R_S = 50\ \Omega$	Full range	6		$\mu\text{V}/^\circ\text{C}$	
	Input offset voltage long-term drift (see Note 4)		25°C	0.04		$\mu\text{V}/\text{mo}$	
I_{IO}	Input offset current		25°C	1		pA	
			Full range	0.8		nA	
I_{IB}	Input bias current		25°C	3		pA	
			Full range	2		nA	
V_{ICR}	Common-mode input voltage range		25°C	-1.6 to 4	-2 to 6	V	
			Full range	-1.6 to 4		V	
V_{OM+}	Maximum positive peak output voltage swing	$R_L = 10\ \text{k}\Omega$	25°C	3.5	3.7	V	
			Full range	3.3			
			$R_L = 100\ \Omega$	25°C	2.5		3.1
			Full range	2			
V_{OM-}	Maximum negative peak output voltage swing	$R_L = 10\ \text{k}\Omega$	25°C	-3.7	-3.9	V	
			Full range	-3.3			
			$R_L = 100\ \Omega$	25°C	-2.5		-2.7
			Full range	-2			
A_{VD}	Large-signal differential voltage amplification	$V_O = \pm 2.8\ \text{V},$ $R_L = 10\ \text{k}\Omega$	25°C	15	80	V/mV	
			Full range	2			
			$V_O = 0\ \text{to}\ 2\ \text{V},$ $R_L = 100\ \Omega$	25°C	0.75		45
			Full range	0.5			
			$V_O = 0\ \text{to}\ -2\ \text{V},$ $R_L = 100\ \Omega$	25°C	0.5		3
			Full range	0.25			
r_i	Input resistance		25°C	10^{12}		Ω	
c_i	Input capacitance		25°C	4		pF	
z_o	Open-loop output impedance	$I_O = 0$	25°C	560		Ω	
CMRR	Common-mode rejection ratio	$V_{IC} = V_{ICR\text{min}},$ $R_S = 50\ \Omega$	25°C	65	82	dB	
			Full range	65			
k_{SVR}	Supply-voltage rejection ratio ($\Delta V_{CC\pm}/\Delta V_{IO}$)	$V_{CC\pm} = \pm 5\ \text{V to } \pm 15\ \text{V},$ $R_S = 50\ \Omega$	25°C	75	93	dB	
			Full range	75			

† Full range is 0°C to 70°C.

NOTE 4: Typical values are based on the input offset voltage shift observed through 168 hours of operating life test at $T_A = 150^\circ\text{C}$ extrapolated to $T_A = 25^\circ\text{C}$ using the Arrhenius equation and assuming an activation energy of 0.96 eV.



TLE206x, TLE206xA, TLE206xB
EXCALIBUR JFET-INPUT HIGH-OUTPUT-DRIVE
μPOWER OPERATIONAL AMPLIFIERS

SLOS193B – FEBRUARY 1997 – REVISED MAY 2004

TLE2062C electrical characteristics at specified free-air temperature, $V_{CC\pm} = \pm 5\text{ V}$ (unless otherwise noted) (continued)

PARAMETER	TEST CONDITIONS	T_A †	TLE2062C TLE2062AC TLE2062BC			UNIT
			MIN	TYP	MAX	
I_{CC} Supply current	$V_O = 0$, No load	25°C		560	620	μA
		Full range			635	
ΔI_{CC} Supply-current change over operating temperature range		Full range		26		μA

† Full range is 0°C to 70°C.

TLE2062C operating characteristics at specified free-air temperature, $V_{CC\pm} = \pm 5\text{ V}$

PARAMETER	TEST CONDITIONS	T_A †	TLE2062C TLE2062AC TLE2062BC			UNIT
			MIN	TYP	MAX	
SR Slew rate at unity gain (see Figure 1)	$R_L = 10\text{ k}\Omega$, $C_L = 100\text{ pF}$	25°C	2.2	3.4		V/μs
		Full range	2.1			
V_n Equivalent input noise voltage (see Figure 2)	$f = 10\text{ Hz}$, $R_S = 20\ \Omega$	25°C		59	100	nV/√Hz
	$f = 1\text{ kHz}$, $R_S = 20\ \Omega$	25°C		43	60	
$V_{N(PP)}$ Peak-to-peak equivalent input noise voltage	$f = 0.1\text{ Hz to }10\text{ Hz}$	25°C		1.1		μV
I_n Equivalent input noise current	$f = 1\text{ kHz}$	25°C		1		fA/√Hz
THD Total harmonic distortion	$V_{O(PP)} = 2\text{ V}$, $R_L = 10\text{ k}\Omega$, $A_{VD} = 2$, $f = 10\text{ kHz}$	25°C		0.025%		
B_1 Unity-gain bandwidth (see Figure 3)	$R_L = 10\text{ k}\Omega$, $C_L = 100\text{ pF}$	25°C		1.8		MHz
	$R_L = 100\ \Omega$, $C_L = 100\text{ pF}$	25°C		1.3		
Settling time	0.1%	25°C		5		μs
	0.01%	25°C		10		
BOM Maximum output-swing bandwidth	$A_{VD} = 1$, $R_L = 10\text{ k}\Omega$	25°C		140		kHz
ϕ_m Phase margin at unity gain (see Figure 3)	$R_L = 10\text{ k}\Omega$, $C_L = 100\text{ pF}$	25°C		58°		
	$R_L = 100\ \Omega$, $C_L = 100\text{ pF}$	25°C		75°		

† Full range is 0°C to 70°C.



TLE206x, TLE206xA, TLE206xB
EXCALIBUR JFET-INPUT HIGH-OUTPUT-DRIVE
μPOWER OPERATIONAL AMPLIFIERS

SLOS193B – FEBRUARY 1997 – REVISED MAY 2004

TLE2062C electrical characteristics at specified free-air temperature, $V_{CC\pm} = \pm 15\text{ V}$ (unless otherwise noted)

PARAMETER		TEST CONDITIONS	T_A †	TLE2062C TLE2062AC TLE2062BC			UNIT		
				MIN	TYP	MAX			
V_{IO} Input offset voltage	TLE2062C	$V_{IC} = 0, \quad R_S = 50\ \Omega$	25°C	0.9		4	mV		
			Full range			4.9			
			25°C	0.8		2			
			Full range			2.9			
	TLE2062AC		25°C	0.5		1			
			Full range			1.9			
	TLE2062BC		25°C	6				$\mu\text{V}/^\circ\text{C}$	
			Full range			0.04		$\mu\text{V}/\text{mo}$	
	α_{VIO} Temperature coefficient of input offset voltage		Input offset voltage long-term drift (see Note 4)		25°C	2		pA	
	I_{IO} Input offset current				25°C	4		pA	
	I_{IB} Input bias current				25°C	3		nA	
	V_{ICR} Common-mode input voltage range				25°C	-11 to 13		-12 to 16	V
			Full range	-11 to 13		V			
V_{OM+} Maximum positive peak output voltage swing	$R_L = 10\ \text{k}\Omega$		25°C	13.2	13.7	V			
			Full range	13					
	$R_L = 600\ \Omega$		25°C	12.5	13.2				
			Full range	12					
V_{OM-} Maximum negative peak output voltage swing	$R_L = 10\ \text{k}\Omega$		25°C	-13.2	-13.7	V			
			Full range	-13					
	$R_L = 600\ \Omega$		25°C	-12.5	-13				
			Full range	-12					
A_{VD} Large-signal differential voltage amplification	$V_O = \pm 10\ \text{V}, \quad R_L = 10\ \text{k}\Omega$		25°C	30	230	V/mV			
			Full range	20					
	$V_O = 0\ \text{to}\ 8\ \text{V}, \quad R_L = 600\ \Omega$		25°C	25	100				
			Full range	10					
	$V_O = 0\ \text{to}\ -8\ \text{V}, \quad R_L = 600\ \Omega$		25°C	3	25				
			Full range	1					
r_i Input resistance			25°C	10^{12}		Ω			
c_i Input capacitance			25°C	4		pF			
z_o Open-loop output impedance	$I_O = 0$		25°C	560		Ω			
CMRR Common-mode rejection ratio	$V_{IC} = V_{ICRmin}, \quad R_S = 50\ \Omega$		25°C	72	90	dB			
			Full range	70					
k_{SVR} Supply-voltage rejection ratio ($\Delta V_{CC\pm}/\Delta V_{IO}$)	$V_{CC\pm} = \pm 5\ \text{V}\ \text{to}\ \pm 15\ \text{V}, \quad R_S = 50\ \Omega$		25°C	75	93	dB			
			Full range	75					

† Full range is 0°C to 70°C.

NOTE 4: Typical values are based on the input offset voltage shift observed through 168 hours of operating life test at $T_A = 150^\circ\text{C}$ extrapolated to $T_A = 25^\circ\text{C}$ using the Arrhenius equation and assuming an activation energy of 0.96 eV.



TLE206x, TLE206xA, TLE206xB
EXCALIBUR JFET-INPUT HIGH-OUTPUT-DRIVE
μPOWER OPERATIONAL AMPLIFIERS

SLOS193B – FEBRUARY 1997 – REVISED MAY 2004

TLE2062C electrical characteristics at specified free-air temperature, $V_{CC\pm} = \pm 15$ V (unless otherwise noted) (continued)

PARAMETER	TEST CONDITIONS	T_A †	TLE2062C TLE2062AC TLE2062BC			UNIT
			MIN	TYP	MAX	
I_{CC} Supply current	$V_O = 0$ V, No load	25°C		625	690	μA
		Full range		715		
ΔI_{CC} Supply-current change over operating temperature range		Full range		36		μA

† Full range is 0°C to 70°C.

TLE2062C operating characteristics at specified free-air temperature, $V_{CC\pm} = \pm 15$ V

PARAMETER	TEST CONDITIONS	T_A †	TLE2062C TLE2062AC TLE2062BC			UNIT
			MIN	TYP	MAX	
SR Slew rate at unity gain (see Figure 1)	$R_L = 10$ kΩ, $C_L = 100$ pF	25°C	2.6	3.4		V/μs
		Full range	2.5			
V_n Equivalent input noise voltage (see Figure 2)	$f = 10$ Hz, $R_S = 20$ Ω	25°C		70	100	nV/√Hz
	$f = 1$ kHz, $R_S = 20$ Ω	25°C		40	60	
$V_{N(PP)}$ Peak-to-peak equivalent input noise voltage	$f = 0.1$ Hz to 10 Hz	25°C		1.1		μV
I_n Equivalent input noise current	$f = 1$ kHz	25°C		1.1		fA/√Hz
THD Total harmonic distortion	$V_{O(PP)} = 2$ V, $R_L = 10$ kΩ, $A_{VD} = 2$, $f = 10$ kHz	25°C	0.025%			
B_1 Unity-gain bandwidth (see Figure 3)	$R_L = 10$ kΩ, $C_L = 10$ pF	25°C	2			MHz
	$R_L = 600$ Ω, $C_L = 100$ pF	25°C	1.5			
Settling time	0.1%	25°C	5			μs
	0.01%	25°C	10			
B_{OM} Maximum output-swing bandwidth	$A_{VD} = 1$, $R_L = 10$ kΩ	25°C	40			kHz
ϕ_m Phase margin at unity gain (see Figure 3)	$R_L = 10$ kΩ, $C_L = 100$ pF	25°C	60°			
	$R_L = 600$ Ω, $C_L = 100$ pF	25°C	70°			

† Full range is 0°C to 70°C.



TLE206x, TLE206xA, TLE206xB
EXCALIBUR JFET-INPUT HIGH-OUTPUT-DRIVE
μPOWER OPERATIONAL AMPLIFIERS

SLOS193B – FEBRUARY 1997 – REVISED MAY 2004

TLE2062I electrical characteristics at specified free-air temperature, $V_{CC\pm} = \pm 5\text{ V}$ (unless otherwise noted)

PARAMETER		TEST CONDITIONS	T_A^\dagger	TLE2062I TLE2062AI TLE2062BI			UNIT
				MIN	TYP	MAX	
V_{IO}	Input offset voltage	$V_{IC} = 0, R_S = 50\ \Omega$	25°C	1	5	mV	
			Full range	6.3			
			25°C	0.9	4		
			Full range	5.3			
			25°C	0.7	3		
			Full range	4.3			
α_{VIO}	Temperature coefficient of input offset voltage	$V_{IC} = 0, R_S = 50\ \Omega$	Full range	6		$\mu\text{V}/^\circ\text{C}$	
	Input offset voltage long-term drift (see Note 4)		25°C	0.04		$\mu\text{V}/\text{mo}$	
I_{IO}	Input offset current		25°C	1		pA	
			Full range	2		nA	
I_{IB}	Input bias current		25°C	3		pA	
			Full range	4		nA	
V_{ICR}	Common-mode input voltage range	25°C	-1.6 to 4	-2 to 6	V		
		Full range	-1.6 to 4		V		
V_{OM+}	Maximum positive peak output voltage swing	$R_L = 10\ \text{k}\Omega$	25°C	3.5	3.7	V	
			Full range	3.1			
			25°C	2.5	3.1		
			Full range	2			
V_{OM-}	Maximum negative peak output voltage swing	$R_L = 10\ \text{k}\Omega$	25°C	-3.7	-3.9	V	
			Full range	-3.1			
			25°C	-2.5	-2.7		
			Full range	-2			
A_{VD}	Large-signal differential voltage amplification	$V_O = \pm 2.8\ \text{V}, R_L = 10\ \text{k}\Omega$	25°C	15	80	V/mV	
			Full range	2			
		$V_O = 0\ \text{to}\ 2\ \text{V}, R_L = 100\ \Omega$	25°C	0.75	45		
			Full range	0.5			
		$V_O = 0\ \text{to}\ -2\ \text{V}, R_L = 100\ \Omega$	25°C	0.5	3		
			Full range	0.25			
r_i	Input resistance		25°C	10^{12}		Ω	
c_i	Input capacitance		25°C	4		pF	
z_o	Open-loop output impedance	$I_O = 0$	25°C	560		Ω	
CMRR	Common-mode rejection ratio	$V_{IC} = V_{ICRmin}, R_S = 50\ \Omega$	25°C	65	82	dB	
			Full range	65			
k_{SVR}	Supply-voltage rejection ratio ($\Delta V_{CC\pm}/\Delta V_{IO}$)	$V_{CC\pm} = \pm 5\ \text{V}\ \text{to}\ \pm 15\ \text{V}, R_S = 50\ \Omega$	25°C	75	93	dB	
			Full range	65			

† Full range is -40°C to 85°C .

NOTE 4: Typical values are based on the input offset voltage shift observed through 168 hours of operating life test at $T_A = 150^\circ\text{C}$ extrapolated to $T_A = 25^\circ\text{C}$ using the Arrhenius equation and assuming an activation energy of 0.96 eV.



TLE206x, TLE206xA, TLE206xB
EXCALIBUR JFET-INPUT HIGH-OUTPUT-DRIVE
μPOWER OPERATIONAL AMPLIFIERS

SLOS193B – FEBRUARY 1997 – REVISED MAY 2004

TLE2062I electrical characteristics at specified free-air temperature, $V_{CC\pm} = \pm 5\text{ V}$ (unless otherwise noted) (continued)

PARAMETER	TEST CONDITIONS	T_A^\dagger	TLE2062I TLE2062AI TLE2062BI			UNIT
			MIN	TYP	MAX	
I_{CC} Supply current	$V_O = 0$, No load	25°C		560	620	μA
		Full range			640	
ΔI_{CC} Supply-current change over operating temperature range		Full range		54		μA

† Full range is -40°C to 85°C .

TLE2062I operating characteristics at specified free-air temperature, $V_{CC\pm} = \pm 5\text{ V}$

PARAMETER	TEST CONDITIONS	T_A^\dagger	TLE2062I TLE2062AI TLE2062BI			UNIT
			MIN	TYP	MAX	
SR Slew rate at unity gain (see Figure 1)	$R_L = 10\text{ k}\Omega$, $C_L = 100\text{ pF}$	25°C	2.2	3.4		$\text{V}/\mu\text{s}$
		Full range	1.7			
V_n Equivalent input noise voltage (see Figure 2)	$f = 10\text{ Hz}$, $R_S = 20\ \Omega$	25°C		59	100	$\text{nV}/\sqrt{\text{Hz}}$
	$f = 1\text{ kHz}$, $R_S = 20\ \Omega$	25°C		43	60	
$V_{N(PP)}$ Peak-to-peak equivalent input noise voltage	$f = 0.1\text{ Hz}$ to 10 Hz	25°C		1.1		μV
I_n Equivalent input noise current	$f = 1\text{ kHz}$	25°C		1		$\text{fA}/\sqrt{\text{Hz}}$
THD Total harmonic distortion	$V_{O(PP)} = 2\text{ V}$, $R_L = 10\text{ k}\Omega$, $A_{VD} = 2$, $f = 10\text{ kHz}$	25°C		0.025%		
B_1 Unity-gain bandwidth (see Figure 3)	$R_L = 10\text{ k}\Omega$, $C_L = 100\text{ pF}$	25°C		1.8		MHz
	$R_L = 100\ \Omega$, $C_L = 100\text{ pF}$	25°C		1.3		
Settling time	0.1%	25°C		5		μs
	0.01%	25°C		10		
BOM Maximum output-swing bandwidth	$A_{VD} = 1$, $R_L = 10\text{ k}\Omega$	25°C		140		kHz
ϕ_m Phase margin at unity gain (see Figure 3)	$R_L = 10\text{ k}\Omega$, $C_L = 100\text{ pF}$	25°C		58°		
	$R_L = 100\ \Omega$, $C_L = 100\text{ pF}$	25°C		75°		

† Full range is -40°C to 85°C .



TLE206x, TLE206xA, TLE206xB
EXCALIBUR JFET-INPUT HIGH-OUTPUT-DRIVE
μPOWER OPERATIONAL AMPLIFIERS

SLOS193B – FEBRUARY 1997 – REVISED MAY 2004

TLE2062I electrical characteristics at specified free-air temperature, $V_{CC\pm} = \pm 15\text{ V}$ (unless otherwise noted)

PARAMETER		TEST CONDITIONS	T_A^\dagger	TLE2062I TLE2062AI TLE2062BI			UNIT
				MIN	TYP	MAX	
V_{IO}	Input offset voltage	$V_{IC} = 0,$ $R_S = 50\ \Omega$	25°C	0.9	4	mV	
			Full range	5.3			
			25°C	0.8	2		
			Full range	3.3			
			25°C	0.5	1		
			Full range	2.3			
α_{VIO}	Temperature coefficient of input offset voltage	$V_{IC} = 0,$ $R_S = 50\ \Omega$	Full range	6		$\mu\text{V}/^\circ\text{C}$	
	Input offset voltage long-term drift (see Note 4)		25°C	0.04		$\mu\text{V}/\text{mo}$	
I_{IO}	Input offset current		25°C	2		pA	
			Full range	3		nA	
I_{IB}	Input bias current		25°C	4		pA	
			Full range	5		nA	
V_{ICR}	Common-mode input voltage range		25°C	-11 to 13	-12 to 16	V	
			Full range	-11 to 13		V	
V_{OM+}	Maximum positive peak output voltage swing	$R_L = 10\ \text{k}\Omega$	25°C	13.2	13.7	V	
			Full range	13			
			$R_L = 600\ \Omega$	25°C	12.5		13.2
				Full range	12		
V_{OM-}	Maximum negative peak output voltage swing	$R_L = 10\ \text{k}\Omega$	25°C	-13.2	-13.7	V	
			Full range	-13			
			$R_L = 600\ \Omega$	25°C	-12.5		-13
				Full range	-12		
A_{VD}	Large-signal differential voltage amplification	$V_O = \pm 10\ \text{V},$ $R_L = 10\ \text{k}\Omega$	25°C	30	230	V/mV	
			Full range	20			
		$V_O = 0\ \text{to}\ 8\ \text{V},$ $R_L = 600\ \Omega$	25°C	25	100		
			Full range	10			
		$V_O = 0\ \text{to}\ -8\ \text{V},$ $R_L = 600\ \Omega$	25°C	3	25		
			Full range	1			
r_i	Input resistance		25°C	10^{12}		Ω	
c_i	Input capacitance		25°C	4		pF	
z_o	Open-loop output impedance	$I_O = 0$	25°C	560		Ω	
CMRR	Common-mode rejection ratio	$V_{IC} = V_{ICR\text{min}},$ $R_S = 50\ \Omega$	25°C	72	90	dB	
			Full range	65			
k_{SVR}	Supply-voltage rejection ratio ($\Delta V_{CC\pm}/\Delta V_{IO}$)	$V_{CC\pm} = \pm 5\ \text{V}\ \text{to}\ \pm 15\ \text{V},$ $R_S = 50\ \Omega$	25°C	75	93	dB	
			Full range	65			

† Full range is -40°C to 85°C .

NOTE 4: Typical values are based on the input offset voltage shift observed through 168 hours of operating life test at $T_A = 150^\circ\text{C}$ extrapolated to $T_A = 25^\circ\text{C}$ using the Arrhenius equation and assuming an activation energy of 0.96 eV.



TLE206x, TLE206xA, TLE206xB
EXCALIBUR JFET-INPUT HIGH-OUTPUT-DRIVE
μPOWER OPERATIONAL AMPLIFIERS

SLOS193B – FEBRUARY 1997 – REVISED MAY 2004

TLE2062I electrical characteristics at specified free-air temperature, $V_{CC\pm} = \pm 15$ V (unless otherwise noted) (continued)

PARAMETER	TEST CONDITIONS	T_A †	TLE2062I TLE2062AI TLE2062BI			UNIT
			MIN	TYP	MAX	
I_{CC} Supply current	$V_O = 0$, No load	25°C		625	690	μA
		Full range			720	
ΔI_{CC} Supply-current change over operating temperature range		Full range		74		μA

† Full range is –40°C to 85°C.

TLE2062I operating characteristics at specified free-air temperature, $V_{CC\pm} = \pm 15$ V

PARAMETER	TEST CONDITIONS	T_A †	TLE2062I TLE2062AI TLE2062BI			UNIT
			MIN	TYP	MAX	
SR Slew rate at unity gain (see Figure 1)	$R_L = 10$ kΩ, $C_L = 100$ pF	25°C	2.6	3.4		V/μs
		Full range	2.1			
V_n Equivalent input noise voltage (see Figure 2)	$f = 10$ Hz, $R_S = 20$ Ω	25°C		70	100	nV/√Hz
	$f = 1$ kHz, $R_S = 20$ Ω	25°C		40	60	
$V_{N(PP)}$ Peak-to-peak equivalent input noise voltage	$f = 0.1$ Hz to 10 Hz	25°C		1.1		μV
I_n Equivalent input noise current	$f = 1$ kHz	25°C		1.1		fA/√Hz
THD Total harmonic distortion	$V_{O(PP)} = 2$ V, $R_L = 10$ kΩ, $A_{VD} = 2$, $f = 10$ kHz	25°C		0.025%		
B_1 Unity-gain bandwidth (see Figure 3)	$R_L = 10$ kΩ, $C_L = 100$ pF	25°C		2		MHz
	$R_L = 600$ Ω, $C_L = 100$ pF	25°C		1.5		
Settling time	0.1%	25°C		5		μs
	0.01%	25°C		10		
BOM Maximum output-swing bandwidth	$A_{VD} = 1$, $R_L = 10$ kΩ	25°C		40		kHz
ϕ_m Phase margin at unity gain (see Figure 3)	$R_L = 10$ kΩ, $C_L = 100$ pF	25°C		60°		
	$R_L = 600$ Ω, $C_L = 100$ pF	25°C		70°		

† Full range is –40°C to 85°C.



TLE206x, TLE206xA, TLE206xB
EXCALIBUR JFET-INPUT HIGH-OUTPUT-DRIVE
μPOWER OPERATIONAL AMPLIFIERS

SLOS193B – FEBRUARY 1997 – REVISED MAY 2004

TLE2062M electrical characteristics at specified free-air temperature, $V_{CC\pm} = \pm 5\text{ V}$

PARAMETER		TEST CONDITIONS	T_A †	TLE2062M TLE2062AM TLE2062BM			UNIT
				MIN	TYP	MAX	
V_{IO}	Input offset voltage	$V_{IC} = 0, \quad R_S = 50\ \Omega$	25°C	1	5	mV	
			Full range	7			
			25°C	0.9	4		
	Full range		6				
	25°C		0.7	3			
	Full range		5				
	α_{VIO}		Temperature coefficient of input offset voltage	Full range	6		$\mu\text{V}/^\circ\text{C}$
			Input offset voltage long-term drift (see Note 4)	25°C	0.04		$\mu\text{V}/\text{mo}$
	I_{IO}		Input offset current	25°C	1		pA
I_{IB}	Input bias current	Full range	15		nA		
		25°C	3		pA		
V_{ICR}	Common-mode input voltage range	25°C	-1.6 to 4	-2 to 6	V		
		Full range	-1.6 to 4		V		
V_{OM+}	Maximum positive peak output voltage swing	$R_L = 10\ \text{k}\Omega$	25°C	3.5	3.7	V	
			Full range	3			
		FK and JG packages	$R_L = 600\ \Omega$	25°C	2.5		3.6
				Full range	2		
		D and P packages	$R_L = 100\ \Omega$	25°C	2.5		3.1
				Full range	2		
V_{OM-}	Maximum negative peak output voltage swing	$R_L = 10\ \text{k}\Omega$	25°C	-3.5	-3.9	V	
			Full range	-3			
		FK and JG packages	$R_L = 600\ \Omega$	25°C	-2.5		-3.5
				Full range	-2		
		D and P packages	$R_L = 100\ \Omega$	25°C	-2.5		-2.7
				Full range	-2		
A_{VD}	Large-signal differential voltage amplification	$V_O = \pm 2.8\ \text{V}, \quad R_L = 10\ \text{k}\Omega$	25°C	15	80	V/mV	
			Full range	2			
		FK and JG packages	$V_O = 0\ \text{to}\ 2.5\ \text{V}, \quad R_L = 600\ \Omega$	25°C	1		65
				Full range	0.5		
			$V_O = 0\ \text{to}\ -2.5\ \text{V}, \quad R_L = 600\ \Omega$	25°C	1		16
				Full range	0.5		
		D and P packages	$V_O = 0\ \text{to}\ 2\ \text{V}, \quad R_L = 100\ \Omega$	25°C	0.75		45
				Full range	0.5		
			$V_O = 0\ \text{to}\ -2\ \text{V}, \quad R_L = 100\ \Omega$	25°C	0.5		3
				Full range	0.25		

† Full range is -55°C to 125°C .

NOTE 4: Typical values are based on the input offset voltage shift observed through 168 hours of operating life test at $T_A = 150^\circ\text{C}$ extrapolated to $T_A = 25^\circ\text{C}$ using the Arrhenius equation and assuming an activation energy of 0.96 eV.



TLE206x, TLE206xA, TLE206xB
EXCALIBUR JFET-INPUT HIGH-OUTPUT-DRIVE
μPOWER OPERATIONAL AMPLIFIERS

SLOS193B – FEBRUARY 1997 – REVISED MAY 2004

TLE2062M electrical characteristics at specified free-air temperature, $V_{CC\pm} = \pm 5\text{ V}$ (unless otherwise noted)

PARAMETER	TEST CONDITIONS	T_A †	TLE2062M TLE2062AM TLE2062BM			UNIT
			MIN	TYP	MAX	
r_i Input resistance		25°C	10 ¹²			Ω
c_i Input capacitance		25°C	4			pF
z_o Open-loop output impedance	$I_O = 0$	25°C	560			Ω
CMRR Common-mode rejection ratio	$V_{IC} = V_{ICRmin}$ $R_S = 50\ \Omega$	25°C	65	82		dB
		Full range	60			
k_{SVR} Supply-voltage rejection ratio ($\Delta V_{CC\pm}/\Delta V_{IO}$)	$V_{CC\pm} = \pm 5\text{ V to } \pm 15\text{ V}$, $R_S = 50\ \Omega$	25°C	75	93		dB
		Full range	65			
I_{CC} Supply current (two amplifiers)	$V_O = 0$, No load	25°C	560	620		μA
		Full range		650		
ΔI_{CC} Supply-current change over operating temperature range (two amplifiers)		Full range	72			μA

† Full range is -55°C to 125°C.

TLE2062M operating characteristics at specified free-air temperature, $T_A = 25^\circ\text{C}$, $V_{CC\pm} = \pm 5\text{ V}$

PARAMETER	TEST CONDITIONS	TLE2062M TLE2062AM TLE2062BM			UNIT
		MIN	TYP	MAX	
SR Slew rate at unity gain (see Figure 1)	$R_L = 10\text{ k}\Omega$, $C_L = 100\text{ pF}$	3.4			V/μs
V_n Equivalent input noise voltage (see Figure 2)	$f = 10\text{ Hz}$, $R_S = 20\ \Omega$	59			nV/√Hz
	$f = 1\text{ kHz}$, $R_S = 20\ \Omega$	43			
$V_{N(PP)}$ Peak-to-peak equivalent input noise voltage	$f = 0.1\text{ Hz to } 10\text{ Hz}$	1.1			μV
I_n Equivalent input noise current	$f = 1\text{ kHz}$	1			fA/√Hz
THD Total harmonic distortion	$V_{O(PP)} = 2\text{ V}$, $R_L = 10\text{ k}\Omega$, $A_{VD} = 2$, $f = 10\text{ kHz}$	0.025%			
B_1 Unity-gain bandwidth (see Figure 3)	$R_L = 10\text{ k}\Omega$, $C_L = 100\text{ pF}$	1.8			MHz
	$R_L = 600\ \Omega$, $C_L = 100\text{ pF}$	1.3			
Settling time	0.1%	5			μs
	0.01%	10			
B_{OM} Maximum output-swing bandwidth	$A_{VD} = 1$, $R_L = 10\text{ k}\Omega$	140			kHz
ϕ_m Phase margin at unity gain (see Figure 3)	$R_L = 10\text{ k}\Omega$, $C_L = 100\text{ pF}$	58°			
	$R_L = 600\ \Omega$, $C_L = 100\text{ pF}$	75°			



TLE206x, TLE206xA, TLE206xB
EXCALIBUR JFET-INPUT HIGH-OUTPUT-DRIVE
μPOWER OPERATIONAL AMPLIFIERS

SLOS193B – FEBRUARY 1997 – REVISED MAY 2004

TLE2062M electrical characteristics at specified free-air temperature, $V_{CC\pm} = \pm 15\text{ V}$ (unless otherwise noted)

PARAMETER		TEST CONDITIONS	T_A †	TLE2062M TLE2062AM TLE2062BM			UNIT
				MIN	TYP	MAX	
V_{IO}	Input offset voltage	$V_{IC} = 0$, $R_S = 50\ \Omega$	25°C	0.9	4	mV	
			Full range	6			
			25°C	0.8	2		
			Full range	4			
			25°C	0.5	1		
			Full range	3			
α_{VIO}	Temperature coefficient of input offset voltage	$V_{IC} = 0$, $R_S = 50\ \Omega$	Full range	6		$\mu\text{V}/^\circ\text{C}$	
	Input offset voltage long-term drift (see Note 4)		25°C	0.04		$\mu\text{V}/\text{mo}$	
I_{IO}	Input offset current		25°C	2		pA	
			Full range	20		nA	
I_{IB}	Input bias current		25°C	4		pA	
			Full range	40		nA	
V_{ICR}	Common-mode input voltage range	25°C	-11 to 13	-12 to 16	V		
		Full range	-11 to 13		V		
V_{OM+}	Maximum positive peak output voltage swing	$R_L = 10\ \text{k}\Omega$	25°C	13	13.7	V	
			Full range	12.5			
		$R_L = 600\ \Omega$	25°C	12.5	13.2		
			Full range	11			
V_{OM-}	Maximum negative peak output voltage swing	$R_L = 10\ \text{k}\Omega$	25°C	-13	-13.7	V	
			Full range	-12.5			
		$R_L = 600\ \Omega$	25°C	-12.5	-13		
			Full range	-11			
A_{VD}	Large-signal differential voltage amplification	$V_O = \pm 10\ \text{V}$, $R_L = 10\ \text{k}\Omega$	25°C	30	230	V/mV	
			Full range	20			
		$V_O = 0\ \text{to}\ 8\ \text{V}$, $R_L = 600\ \Omega$	25°C	25	100		
			Full range	7			
		$V_O = 0\ \text{to}\ -8\ \text{V}$, $R_L = 600\ \Omega$	25°C	3	25		
			Full range	1			
r_i	Input resistance		25°C	10^{12}		Ω	
c_i	Input capacitance		25°C	4		pF	
z_o	Open-loop output impedance	$I_O = 0$	25°C	560		Ω	
CMRR	Common-mode rejection ratio	$V_{IC} = V_{ICR\text{min}}$, $R_S = 50\ \Omega$	25°C	72	90	dB	
			Full range	65			
k_{SVR}	Supply-voltage rejection ratio ($\Delta V_{CC\pm}/\Delta V_{IO}$)	$V_{CC\pm} = \pm 5\ \text{V}\ \text{to}\ \pm 15\ \text{V}$, $R_S = 50\ \Omega$	25°C	75	93	dB	
			Full range	65			

† Full range is -55°C to 125°C .

NOTE 4: Typical values are based on the input offset voltage shift observed through 168 hours of operating life test at $T_A = 150^\circ\text{C}$ extrapolated to $T_A = 25^\circ\text{C}$ using the Arrhenius equation and assuming an activation energy of 0.96 eV.



TLE206x, TLE206xA, TLE206xB
EXCALIBUR JFET-INPUT HIGH-OUTPUT-DRIVE
μPOWER OPERATIONAL AMPLIFIERS

SLOS193B – FEBRUARY 1997 – REVISED MAY 2004

TLE2062M electrical characteristics at specified free-air temperature, $V_{CC\pm} = \pm 15$ V (unless otherwise noted)

PARAMETER	TEST CONDITIONS	T_A †	TLE2062M TLE2062AM TLE2062BM			UNIT
			MIN	TYP	MAX	
I_{CC} Supply current	$V_O = 0$, No load	25°C		625	690	μA
		Full range			730	
ΔI_{CC} Supply-current change over operating temperature range		Full range		97		μA

† Full range is –55°C to 125°C.

TLE2062M operating characteristics at specified free-air temperature, $V_{CC\pm} = \pm 15$ V

PARAMETER	TEST CONDITIONS	T_A †	TLE2062M TLE2062AM TLE2062BM			UNIT
			MIN	TYP	MAX	
SR Slew rate at unity gain (see Figure 1)	$R_L = 10$ kΩ, $C_L = 100$ pF	25°C	2	3.4		V/μs
		Full range	1.8			
V_n Equivalent input noise voltage (see Figure 2)	$f = 10$ Hz, $R_S = 20$ Ω	25°C		70		nV/√Hz
	$f = 1$ kHz, $R_S = 20$ Ω	25°C		40		
$V_{N(PP)}$ Peak-to-peak equivalent input noise voltage	$f = 0.1$ Hz to 10 Hz	25°C		1.1		μV
I_n Equivalent input noise current	$f = 1$ kHz	25°C		1.1		fA/√Hz
THD Total harmonic distortion	$V_{O(PP)} = 2$ V, $R_L = 10$ kΩ, $A_{VD} = 2$, $f = 10$ kHz	25°C		0.025%		
B_1 Unity-gain bandwidth (see Figure 3)	$R_L = 10$ kΩ, $C_L = 100$ pF	25°C		2		MHz
	$R_L = 600$ Ω, $C_L = 100$ pF	25°C		1.5		
Settling time	0.1%	25°C		5		μs
	0.01%	25°C		10		
B_{OM} Maximum output-swing bandwidth	$A_{VD} = 1$, $R_L = 10$ kΩ	25°C		40		kHz
ϕ_m Phase margin at unity gain (see Figure 3)	$R_L = 10$ kΩ, $C_L = 100$ pF	25°C		60°		
	$R_L = 600$ Ω, $C_L = 100$ pF	25°C		70°		

† Full range is –55°C to 125°C.

TLE206x, TLE206xA, TLE206xB
EXCALIBUR JFET-INPUT HIGH-OUTPUT-DRIVE
μPOWER OPERATIONAL AMPLIFIERS

SLOS193B – FEBRUARY 1997 – REVISED MAY 2004

TLE2062Y electrical characteristics at $V_{CC\pm} = \pm 15\text{ V}$, $T_A = 25^\circ\text{C}$ (unless otherwise noted)

PARAMETER	TEST CONDITIONS	TLE2062Y			UNIT
		MIN	TYP	MAX	
V_{IO} Input offset voltage	$V_{IC} = 0$, $R_S = 50\ \Omega$		0.9	4	mV
αV_{IO} Input offset voltage long-term drift (see Note 4)			0.04		$\mu\text{V}/\text{mo}$
I_{IO} Input offset current			2		pA
I_{IB} Input bias current			4		pA
V_{ICR} Common-mode input voltage range		-11 to 13	-12 to 16		V
V_{OM+} Maximum positive peak output voltage swing	$R_L = 10\ \text{k}\Omega$	13.2	13.7		V
	$R_L = 600\ \Omega$	12.5	13.2		
V_{OM-} Maximum negative peak output voltage swing	$R_L = 10\ \text{k}\Omega$	-13.2	-13.7		V
	$R_L = 600\ \Omega$	-12.5	-13		
A_{VD} Large-signal differential voltage amplification	$V_O = \pm 10\ \text{V}$, $R_L = 10\ \text{k}\Omega$	30	230		V/mV
	$V_O = 0$ to $8\ \text{V}$, $R_L = 600\ \Omega$	25	100		
	$V_O = 0$ to $-8\ \text{V}$, $R_L = 600\ \Omega$	3	25		
r_i Input resistance			10^{12}		Ω
c_i Input capacitance			4		pF
z_o Open-loop output impedance	$I_O = 0$		560		Ω
CMRR Common-mode rejection ratio	$V_{IC} = V_{ICR\text{min}}$, $R_S = 50\ \Omega$	72	90		dB
k_{SVR} Supply-voltage rejection ratio ($\Delta V_{CC}/\Delta V_{IO}$)	$V_{CC\pm} = \pm 5\ \text{V}$ to $\pm 15\ \text{V}$, $R_S = 50\ \Omega$	75	93		dB
I_{CC} Supply current	$V_O = 0$, No load		625	690	μA

NOTE 4: Typical values are based on the input offset voltage shift observed through 168 hours of operating life test at $T_A = 150^\circ\text{C}$ extrapolated to $T_A = 25^\circ\text{C}$ using the Arrhenius equation and assuming an activation energy of 0.96 eV.

TLE2062Y operating characteristics at $V_{CC\pm} = \pm 15\ \text{V}$, $T_A = 25^\circ\text{C}$

PARAMETER	TEST CONDITIONS	TLE2062Y			UNIT
		MIN	TYP	MAX	
SR Slew rate at unity gain (see Figure 1)	$R_L = 10\ \text{k}\Omega$, $C_L = 100\ \text{pF}$	2.6	3.4	4	$\text{V}/\mu\text{s}$
V_n Equivalent input noise voltage (see Figure 2)	$f = 10\ \text{Hz}$, $R_S = 20\ \Omega$		70		$\text{nV}/\sqrt{\text{Hz}}$
	$f = 1\ \text{kHz}$, $R_S = 20\ \Omega$		40		
$V_{N(PP)}$ Peak-to-peak equivalent input noise voltage	$f = 0.1\ \text{Hz}$ to $10\ \text{Hz}$		1.1		μV
I_n Equivalent input noise current	$f = 1\ \text{Hz}$		1.1		$\text{fA}/\sqrt{\text{Hz}}$
THD Total harmonic distortion	$V_{O(PP)} = 2\ \text{V}$, $R_L = 10\ \text{k}\Omega$, $A_{VD} = 2$, $f = 10\ \text{kHz}$		0.025%		
B_1 Unity-gain bandwidth (see Figure 3)	$R_L = 10\ \text{k}\Omega$, $C_L = 100\ \text{pF}$		2		MHz
	$R_L = 600\ \Omega$, $C_L = 100\ \text{pF}$		1.5		
Settling time	0.1%		5		μs
	0.01%		10		
B_{OM} Maximum output-swing bandwidth	$A_{VD} = 1$, $R_L = 10\ \text{k}\Omega$		40		kHz
ϕ_m Phase margin at unity gain (see Figure 3)	$R_L = 10\ \text{k}\Omega$, $C_L = 100\ \text{pF}$		60°		
	$R_L = 600\ \Omega$, $C_L = 100\ \text{pF}$		70°		



TLE206x, TLE206xA, TLE206xB
EXCALIBUR JFET-INPUT HIGH-OUTPUT-DRIVE
μPOWER OPERATIONAL AMPLIFIERS

SLOS193B – FEBRUARY 1997 – REVISED MAY 2004

TLE2064C electrical characteristics at specified free-air temperature, $V_{CC\pm} = \pm 5\text{ V}$ (unless otherwise noted)

PARAMETER		TEST CONDITIONS	T_A †	TLE2064C TLE2064AC TLE2064BC			UNIT
				MIN	TYP	MAX	
V_{IO}	Input offset voltage	$V_{IC} = 0, R_S = 50\ \Omega$	25°C	1.2	7	mV	
			Full range		7.9		
			25°C	1.2	6		
			Full range		6.9		
α_{VIO}	Temperature coefficient of input offset voltage	$V_{IC} = 0, R_S = 50\ \Omega$	25°C	6		$\mu\text{V}/^\circ\text{C}$	
			Full range	0.04		$\mu\text{V}/\text{mo}$	
I_{IO}	Input offset current	$V_{IC} = 0, R_S = 50\ \Omega$	25°C	1		pA	
			Full range		0.8	nA	
I_{IB}	Input bias current	$V_{IC} = 0, R_S = 50\ \Omega$	25°C	3		pA	
			Full range		2	nA	
V_{ICR}	Common-mode input voltage range		25°C	-1.6 to 4	-2 to 6	V	
			Full range	-1.6 to 4		V	
V_{OM+}	Maximum positive peak output voltage swing	$R_L = 10\ \text{k}\Omega$	25°C	3.5	3.7	V	
			Full range	3.3			
		$R_L = 100\ \Omega$	25°C	2.5	3.1		
			Full range	2			
V_{OM-}	Maximum negative peak output voltage swing	$R_L = 10\ \text{k}\Omega$	25°C	-3.7	-3.9	V	
			Full range	-3.3			
		$R_L = 100\ \Omega$	25°C	-2.5	-2.7		
			Full range	-2			
A_{VD}	Large-signal differential voltage amplification	$V_O = \pm 2.8\ \text{V}, R_L = 10\ \text{k}\Omega$	25°C	15	80	V/mV	
			Full range	2			
		$V_O = 0\ \text{to}\ 2\ \text{V}, R_L = 100\ \Omega$	25°C	0.75	45		
			Full range	0.5			
		$V_O = 0\ \text{to}\ -2\ \text{V}, R_L = 100\ \Omega$	25°C	0.5	3		
			Full range	0.15			
r_i	Input resistance		25°C	10^{12}	Ω		
c_i	Input capacitance		25°C	4	pF		
z_o	Open-loop output impedance	$I_O = 0$	25°C	560	Ω		
CMRR	Common-mode rejection ratio	$V_{IC} = V_{ICRmin}, R_S = 50\ \Omega$	25°C	65	82	dB	
			Full range	65			
k_{SVR}	Supply-voltage rejection ratio ($\Delta V_{CC\pm} / \Delta V_{IO}$)	$V_{CC\pm} = \pm 5\ \text{V}\ \text{to}\ \pm 15\ \text{V}, R_S = 50\ \Omega$	25°C	75	93	dB	
			Full range	75			

† Full range is 0°C to 70°C.

NOTE 4: Typical values are based on the input offset voltage shift observed through 168 hours of operating life test at $T_A = 150^\circ\text{C}$ extrapolated to $T_A = 25^\circ\text{C}$ using the Arrhenius equation and assuming an activation energy of 0.96 eV.



TLE206x, TLE206xA, TLE206xB
EXCALIBUR JFET-INPUT HIGH-OUTPUT-DRIVE
μPOWER OPERATIONAL AMPLIFIERS

SLOS193B – FEBRUARY 1997 – REVISED MAY 2004

TLE2064C electrical characteristics at specified free-air temperature, $V_{CC\pm} = \pm 5\text{ V}$ (unless otherwise noted) (continued)

PARAMETER	TEST CONDITIONS	T_A †	TLE2064C TLE2064AC TLE2064BC			UNIT
			MIN	TYP	MAX	
I_{CC} Supply current (four amplifiers)	$V_O = 0$, No load	25°C		1.12	1.3	mA
		Full range			1.3	
ΔI_{CC} Supply-current change over operating temperature range (four amplifiers)		Full range		52		μA
V_{O1}/V_{O2} Crosstalk attenuation	$A_{VD} = 1000$, $f = 1\text{ kHz}$	25°C		120		dB

† Full range is 0°C to 70°C.

TLE2064C operating characteristics at specified free-air temperature, $V_{CC\pm} = \pm 5\text{ V}$

PARAMETER	TEST CONDITIONS	T_A †	TLE2064C TLE2064AC TLE2064BC			UNIT
			MIN	TYP	MAX	
SR Slew rate at unity gain (see Figure 1)	$R_L = 10\text{ k}\Omega$, $C_L = 100\text{ pF}$	25°C		2.2	3.4	V/μs
		Full range		2.1		
V_n Equivalent input noise voltage (see Figure 2)	$f = 10\text{ Hz}$, $R_S = 20\ \Omega$	25°C		59	100	nV/√Hz
	$f = 1\text{ kHz}$, $R_S = 20\ \Omega$			43	60	
$V_{N(PP)}$ Peak-to-peak equivalent input noise voltage	$f = 0.1\text{ Hz to }10\text{ Hz}$	25°C		1.1		μV
I_n Equivalent input noise current	$f = 1\text{ kHz}$	25°C		1		fA/√Hz
THD Total harmonic distortion	$A_{VD} = 2$, $f = 10\text{ kHz}$, $V_{O(PP)} = 2\text{ V}$, $R_L = 10\text{ k}\Omega$	25°C		0.025%		
B_1 Unity-gain bandwidth (see Figure 3)	$R_L = 10\text{ k}\Omega$, $C_L = 100\text{ pF}$	25°C		1.8		MHz
	$R_L = 100\ \Omega$, $C_L = 100\text{ pF}$			1.3		
t_s Settling time	$\epsilon = 0.1\%$	25°C		5		μs
	$\epsilon = 0.01\%$			10		
B_{OM} Maximum output-swing bandwidth	$A_{VD} = 1$, $R_L = 10\text{ k}\Omega$	25°C		140		kHz
ϕ_m Phase margin at unity gain (see Figure 3)	$R_L = 10\text{ k}\Omega$, $C_L = 100\text{ pF}$	25°C		58°		
	$R_L = 100\ \Omega$, $C_L = 100\text{ pF}$			75°		

† Full range is 0°C to 70°C.

TLE206x, TLE206xA, TLE206xB
EXCALIBUR JFET-INPUT HIGH-OUTPUT-DRIVE
μPOWER OPERATIONAL AMPLIFIERS

SLOS193B – FEBRUARY 1997 – REVISED MAY 2004

TLE2064C electrical characteristics at specified free-air temperature, $V_{CC\pm} = \pm 15\text{ V}$ (unless otherwise noted)

PARAMETER		TEST CONDITIONS	T_A †	TLE2064C TLE2064AC TLE2064BC			UNIT
				MIN	TYP	MAX	
V_{IO} Input offset voltage	TLE2064C	$V_{IC} = 0, R_S = 50\ \Omega$	25°C	0.9	6	mV	
			Full range	6.9			
	TLE2064AC		25°C	0.9	4		
			Full range	4.9			
	TLE2064BC		25°C	0.7	2		
			Full range	4			
α_{VIO} Temperature coefficient of input offset voltage		25°C	6		$\mu\text{V}/^\circ\text{C}$		
Input offset voltage long-term drift (see Note 4)		Full range	0.04		$\mu\text{V}/\text{mo}$		
I_{IO} Input offset current		25°C	2		pA		
I_{IB} Input bias current		Full range	1		nA		
		25°C	4		pA		
V_{ICR} Common-mode input voltage range		Full range	3		nA		
		25°C	-11 to 13	-12 to 16	V		
V_{OM+} Maximum positive peak output voltage swing		Full range	-11 to 13		V		
	$R_L = 10\ \text{k}\Omega$	25°C	13.2	13.7	V		
$R_L = 600\ \Omega$	Full range	13					
	25°C	12.5	13.2	V			
Full range	12						
V_{OM-} Maximum negative peak output voltage swing	$R_L = 10\ \text{k}\Omega$	25°C	-13.2	-13.7	V		
	$R_L = 600\ \Omega$	Full range	-13				
		25°C	-12.5	-13			
	Full range	-12					
A_{VD} Large-signal differential voltage amplification	$V_O = \pm 10\ \text{V}, R_L = 10\ \text{k}\Omega$	25°C	30	230	V/mV		
	$V_O = 0\ \text{to}\ 8\ \text{V}, R_L = 600\ \Omega$	Full range	20				
		25°C	25	100			
	$V_O = 0\ \text{to}\ -8\ \text{V}, R_L = 600\ \Omega$	Full range	10				
		25°C	3	25			
	Full range	1					
r_i Input resistance		25°C	10^{12}		Ω		
c_i Input capacitance		25°C	4		pF		
z_o Open-loop output impedance	$I_O = 0$	25°C	560		Ω		
CMRR Common-mode rejection ratio	$V_{IC} = V_{ICR\text{min}}, R_S = 50\ \Omega$	25°C	72	90	dB		
		Full range	70				
k_{SVR} Supply-voltage rejection ratio ($\Delta V_{CC\pm} / \Delta V_{IO}$)	$V_{CC\pm} = \pm 5\ \text{V to } \pm 15\ \text{V}, R_S = 50\ \Omega$	25°C	75	93	dB		
		Full range	75				

† Full range is 0°C to 70°C.

NOTE 4: Typical values are based on the input offset voltage shift observed through 168 hours of operating life test at $T_A = 150^\circ\text{C}$ extrapolated to $T_A = 25^\circ\text{C}$ using the Arrhenius equation and assuming an activation energy of 0.96 eV.



TLE206x, TLE206xA, TLE206xB
EXCALIBUR JFET-INPUT HIGH-OUTPUT-DRIVE
μPOWER OPERATIONAL AMPLIFIERS

SLOS193B – FEBRUARY 1997 – REVISED MAY 2004

TLE2064C electrical characteristics at specified free-air temperature, $V_{CC\pm} = \pm 15\text{ V}$ (unless otherwise noted) (continued)

PARAMETER	TEST CONDITIONS	T_A †	TLE2064C TLE2064AC TLE2064BC			UNIT
			MIN	TYP	MAX	
I_{CC} Supply current (four amplifiers)	$V_O = 0$, No load	25°C	1.25	1.4	mA	
		Full range	1.5			
ΔI_{CC} Supply-current change over operating temperature range (four amplifiers)		Full range	72		μA	
V_{O1}/V_{O2} Crosstalk attenuation	$A_{VD} = 1000$, $f = 1\text{ kHz}$	25°C	120		dB	

† Full range is 0°C to 70°C.

TLE2064C operating characteristics at specified free-air temperature, $V_{CC\pm} = \pm 15\text{ V}$

PARAMETER	TEST CONDITIONS	T_A †	TLE2064C TLE2064AC TLE2064BC			UNIT
			MIN	TYP	MAX	
SR Slew rate at unity gain (see Figure 1)	$R_L = 10\text{ k}\Omega$, $C_L = 100\text{ pF}$	25°C	2.6	3.4	V/μs	
		Full range	2.5			
V_n Equivalent input noise voltage (see Figure 2)	$f = 10\text{ Hz}$, $R_S = 20\ \Omega$	25°C	70		nV/√Hz	
	$f = 1\text{ kHz}$, $R_S = 20\ \Omega$		40			
$V_{N(PP)}$ Peak-to-peak equivalent input noise voltage	$f = 0.1\text{ Hz to }10\text{ Hz}$	25°C	1.1		μV	
I_n Equivalent input noise current	$f = 1\text{ kHz}$	25°C	1		fA/√Hz	
THD Total harmonic distortion	$A_{VD} = 2$, $V_{O(PP)} = 2\text{ V}$, $f = 10\text{ kHz}$, $R_L = 10\text{ k}\Omega$	25°C	0.025%			
B_1 Unity-gain bandwidth (see Figure 3)	$R_L = 10\text{ k}\Omega$, $C_L = 100\text{ pF}$	25°C	2		MHz	
	$R_L = 600\ \Omega$, $C_L = 100\text{ pF}$		1.5			
t_s Settling time	$\epsilon = 0.1\%$	25°C	5		μs	
	$\epsilon = 0.01\%$		10			
B_{OM} Maximum output-swing bandwidth	$A_{VD} = 1$, $R_L = 10\text{ k}\Omega$	25°C	40		kHz	
ϕ_m Phase margin at unity gain (see Figure 3)	$R_L = 10\text{ k}\Omega$, $C_L = 100\text{ pF}$	25°C	50°			
	$R_L = 600\ \Omega$, $C_L = 100\text{ pF}$		70°			

† Full range is 0°C to 70°C.



TLE206x, TLE206xA, TLE206xB
EXCALIBUR JFET-INPUT HIGH-OUTPUT-DRIVE
μPOWER OPERATIONAL AMPLIFIERS

SLOS193B – FEBRUARY 1997 – REVISED MAY 2004

TLE2064I electrical characteristics at specified free-air temperature, $V_{CC\pm} = \pm 5\text{ V}$ (unless otherwise noted)

PARAMETER		TEST CONDITIONS	T_A †	TLE2064I TLE2064AI TLE2064BI			UNIT
				MIN	TYP	MAX	
V_{IO}	Input offset voltage	$V_{IC} = 0,$ $R_S = 50\ \Omega$	25°C	1.2	7	mV	
			Full range	8.3			
			25°C	1.2	6		
			Full range	7.3			
α_{VIO}	Temperature coefficient of input offset voltage	$V_{IC} = 0,$ $R_S = 50\ \Omega$	25°C	0.8	3.5	$\mu\text{V}/^\circ\text{C}$	
			Full range	4.8			
Input offset voltage long-term drift (see Note 4)		$V_{IC} = 0,$ $R_S = 50\ \Omega$	25°C	6		$\mu\text{V}/\text{mo}$	
			Full range	0.04			
I_{IO}	Input offset current	$V_{IC} = 0,$ $R_S = 50\ \Omega$	25°C	1		pA	
			Full range	2		nA	
I_{IB}	Input bias current	$V_{IC} = 0,$ $R_S = 50\ \Omega$	25°C	3		pA	
			Full range	4		nA	
V_{ICR}	Common-mode input voltage range		25°C	-1.6 to 4	-2 to 6	V	
			Full range	-1.6 to 4		V	
V_{OM+}	Maximum positive peak output voltage swing	$R_L = 10\ \text{k}\Omega$	25°C	3.5	3.7	V	
			Full range	3.1			
		$R_L = 100\ \Omega$	25°C	2.5	3.1		
			Full range	2			
V_{OM-}	Maximum negative peak output voltage swing	$R_L = 10\ \text{k}\Omega$	25°C	-3.7	-3.9	V	
			Full range	-3.1			
		$R_L = 100\ \Omega$	25°C	-2.5	-2.7		
			Full range	-2			
A_{VD}	Large-signal differential voltage amplification	$V_O = \pm 2.8\ \text{V},$ $R_L = 10\ \text{k}\Omega$	25°C	15	80	V/mV	
			Full range	2			
		$V_O = 0\ \text{to}\ 2\ \text{V},$ $R_L = 100\ \Omega$	25°C	0.75	45		
			Full range	0.5			
		$V_O = 0\ \text{to}\ -2\ \text{V},$ $R_L = 100\ \Omega$	25°C	0.5	3		
			Full range	0.15			
r_i	Input resistance		25°C	10^{12}		Ω	
c_i	Input capacitance		25°C	4		pF	
z_o	Open-loop output impedance	$I_O = 0$	25°C	560		Ω	
CMRR	Common-mode rejection ratio	$V_{IC} = V_{ICR\text{min}},$ $R_S = 50\ \Omega$	25°C	65	82	dB	
			Full range	65			
k_{SVR}	Supply-voltage rejection ratio ($\Delta V_{CC\pm} / \Delta V_{IO}$)	$V_{CC\pm} = \pm 5\ \text{V}\ \text{to}\ \pm 15\ \text{V},$ $R_S = 50\ \Omega$	25°C	75	93	dB	
			Full range	65			

† Full range is -40°C to 85°C.

NOTE 4: Typical values are based on the input offset voltage shift observed through 168 hours of operating life test at $T_A = 150^\circ\text{C}$ extrapolated to $T_A = 25^\circ\text{C}$ using the Arrhenius equation and assuming an activation energy of 0.96 eV.



TLE206x, TLE206xA, TLE206xB
EXCALIBUR JFET-INPUT HIGH-OUTPUT-DRIVE
μPOWER OPERATIONAL AMPLIFIERS

SLOS193B – FEBRUARY 1997 – REVISED MAY 2004

TLE2064I electrical characteristics at specified free-air temperature, $V_{CC\pm} = \pm 5\text{ V}$ (unless otherwise noted) (continued)

PARAMETER	TEST CONDITIONS	T_A^\dagger	TLE2064I TLE2064AI TLE2064BI			UNIT
			MIN	TYP	MAX	
I_{CC} Supply current (four amplifiers)	$V_O = 0$, No load	25°C	1.12	1.3	mA	
		Full range	1.3			
ΔI_{CC} Supply-current change over operating temperature range (four amplifiers)		Full range	108		μA	
V_{O1}/V_{O2} Crosstalk attenuation	$A_{VD} = 1000$, $f = 1\text{ kHz}$	25°C	120		dB	

† Full range is -40°C to 85°C .

TLE2064I operating characteristics at specified free-air temperature, $V_{CC\pm} = \pm 5\text{ V}$ (unless otherwise noted)

PARAMETER	TEST CONDITIONS	T_A^\dagger	TLE2064I TLE2064AI TLE2064BI			UNIT
			MIN	TYP	MAX	
SR Slew rate at unity gain (see Figure 1)	$R_L = 10\text{ k}\Omega$, $C_L = 100\text{ pF}$	25°C	2.2	3.4	V/μs	
		Full range	1.7			
V_n Equivalent input noise voltage (see Figure 2)	$f = 10\text{ Hz}$, $R_S = 20\ \Omega$	25°C	59		nV/√Hz	
	$f = 1\text{ kHz}$, $f = 1\text{ kHz}$		43			
$V_{N(PP)}$ Peak-to-peak equivalent input noise voltage	$f = 0.1\text{ Hz}$ to 10 Hz	25°C	1.1		μV	
I_n Equivalent input noise current	$f = 1\text{ kHz}$	25°C	1		fA/√Hz	
THD Total harmonic distortion	$A_{VD} = 2$, $f = 10\text{ kHz}$, $V_{O(PP)} = 2\text{ V}$, $R_L = 10\text{ k}\Omega$	25°C	0.025%			
B_1 Unity-gain bandwidth (see Figure 3)	$R_L = 10\text{ k}\Omega$, $C_L = 100\text{ pF}$	25°C	1.8		MHz	
	$R_L = 100\ \Omega$, $C_L = 100\text{ pF}$		1.3			
t_s Settling time	$\epsilon = 0.1\%$	25°C	5		μs	
	$\epsilon = 0.01\%$		10			
B_{OM} Maximum output-swing bandwidth	$A_{VD} = 1$, $R_L = 10\text{ k}\Omega$	25°C	140		kHz	
ϕ_m Phase margin at unity gain (see Figure 3)	$R_L = 10\text{ k}\Omega$, $C_L = 100\text{ pF}$	25°C	58°			
	$R_L = 100\ \Omega$, $C_L = 100\text{ pF}$		75°			

† Full range is -40°C to 85°C .

TLE206x, TLE206xA, TLE206xB
EXCALIBUR JFET-INPUT HIGH-OUTPUT-DRIVE
μPOWER OPERATIONAL AMPLIFIERS

SLOS193B – FEBRUARY 1997 – REVISED MAY 2004

TLE2064I electrical characteristics at specified free-air temperature, $V_{CC\pm} = \pm 15\text{ V}$ (unless otherwise noted)

PARAMETER		TEST CONDITIONS	T_A †	TLE2064I TLE2064AI TLE2064BI			UNIT
				MIN	TYP	MAX	
V_{IO}	Input offset voltage	$V_{IC} = 0,$ $R_S = 50\ \Omega$	25°C	0.9	6	mV	
			Full range	7.3			
			25°C	0.9	4		
			Full range	5.3			
			25°C	0.7	2		
			Full range	3.3			
α_{VIO}	Temperature coefficient of input offset voltage			25°C	6		$\mu\text{V}/^\circ\text{C}$
	Input offset voltage long-term drift (see Note 4)			Full range	0.04		$\mu\text{V}/\text{mo}$
I_{IO}	Input offset current		25°C	2		pA	
			Full range	3		nA	
I_{IB}	Input bias current		25°C	4		pA	
			Full range	5		nA	
V_{ICR}	Common-mode input voltage range		25°C	-11 to 13	-12 to 16	V	
			Full range	-11 to 13		V	
V_{OM+}	Maximum positive peak output voltage swing	$R_L = 10\ \text{k}\Omega$	25°C	13.2	13.7	V	
			Full range	13			
			25°C	12.5	13.2		
			Full range	12			
V_{OM-}	Maximum negative peak output voltage swing	$R_L = 10\ \text{k}\Omega$	25°C	-13.2	-13.7	V	
			Full range	-13			
			25°C	-12.5	-13		
			Full range	-12			
A_{VD}	Large-signal differential voltage amplification	$V_O = \pm 10\ \text{V},$ $R_L = 10\ \text{k}\Omega$	25°C	30	230	V/mV	
			Full range	20			
		$V_O = 0\ \text{to}\ 8\ \text{V},$ $R_L = 600\ \Omega$	25°C	25	100		
			Full range	10			
		$V_O = 0\ \text{to}\ -8\ \text{V},$ $R_L = 600\ \Omega$	25°C	3	25		
			Full range	1			
r_i	Input resistance		25°C	10^{12}		Ω	
c_i	Input capacitance		25°C	4		pF	
z_o	Open-loop output impedance	$I_O = 0$	25°C	560		Ω	
CMRR	Common-mode rejection ratio	$V_{IC} = V_{ICR\text{min}},$ $R_S = 50\ \Omega$	25°C	72	90	dB	
			Full range	65			
k_{SVR}	Supply-voltage rejection ratio ($\Delta V_{CC\pm} / \Delta V_{IO}$)	$V_{CC\pm} = \pm 5\ \text{V}\ \text{to}\ \pm 15\ \text{V},$ $R_S = 50\ \Omega$	25°C	75	93	dB	
			Full range	65			

† Full range is -40°C to 85°C.

NOTE 4: Typical values are based on the input offset voltage shift observed through 168 hours of operating life test at $T_A = 150^\circ\text{C}$ extrapolated to $T_A = 25^\circ\text{C}$ using the Arrhenius equation and assuming an activation energy of 0.96 eV.



TLE206x, TLE206xA, TLE206xB
EXCALIBUR JFET-INPUT HIGH-OUTPUT-DRIVE
μPOWER OPERATIONAL AMPLIFIERS

SLOS193B – FEBRUARY 1997 – REVISED MAY 2004

TLE2064I electrical characteristics at specified free-air temperature, $V_{CC\pm} = \pm 15$ V (unless otherwise noted) (continued)

PARAMETER	TEST CONDITIONS	T_A †	TLE2064I TLE2064AI TLE2064BI			UNIT
			MIN	TYP	MAX	
I_{CC} Supply current (four amplifiers)	$V_O = 0$, No load	25°C	1.25	1.4	mA	
		Full range	1.5			
ΔI_{CC} Supply-current change over operating temperature range (four amplifiers)		Full range	148		μA	
V_{O1}/V_{O2} Crosstalk attenuation	$A_{VD} = 1000$, $f = 1$ kHz	25°C	120		dB	

† Full range is – 40°C to 85°C.

TLE2064I operating characteristics at specified free-air temperature, $V_{CC\pm} = \pm 15$ V

PARAMETER	TEST CONDITIONS	T_A †	TLE2064I TLE2064AI TLE2064BI			UNIT
			MIN	TYP	MAX	
SR Slew rate at unity gain (see Figure 1)	$R_L = 10$ kΩ, $C_L = 100$ pF	25°C	2.6	3.4	V/μs	
		Full range	2.1			
V_n Equivalent input noise voltage (see Figure 2)	$f = 10$ Hz, $R_S = 20$ Ω, $f = 1$ kHz, $R_S = 20$ Ω	25°C	70	100	nV/\sqrt{Hz}	
			40	60		
$V_{N(PP)}$ Peak-to-peak equivalent input noise voltage	$f = 0.1$ Hz to 10 Hz	25°C	1.1		μV	
I_n Equivalent input noise current	$f = 1$ kHz	25°C	1.1		fA/√Hz	
THD Total harmonic distortion	$A_{VD} = 2$, $f = 10$ kHz, $R_L = 10$ kΩ, $V_{O(PP)} = 2$ V,	25°C	0.025%			
B_1 Unity-gain bandwidth (see Figure 3)	$R_L = 10$ kΩ, $C_L = 100$ pF	25°C	2		MHz	
	$R_L = 600$ Ω, $C_L = 100$ pF		1.5			
t_s Settling time	$\epsilon = 0.1\%$	25°C	5		μs	
	$\epsilon = 0.01\%$		10			
B_{OM} Maximum output-swing bandwidth	$A_{VD} = 1$, $R_L = 10$ kΩ	25°C	40		kHz	
ϕ_m Phase margin at unity gain (see Figure 3)	$R_L = 10$ kΩ, $C_L = 100$ pF	25°C	60°			
	$R_L = 600$ Ω, $C_L = 100$ pF		70°			

† Full range is – 40°C to 85°C.

TLE206x, TLE206xA, TLE206xB
EXCALIBUR JFET-INPUT HIGH-OUTPUT-DRIVE
μPOWER OPERATIONAL AMPLIFIERS

SLOS193B – FEBRUARY 1997 – REVISED MAY 2004

TLE2064M electrical characteristics at specified free-air temperature, $V_{CC\pm} = \pm 5\text{ V}$ (unless otherwise noted)

PARAMETER		TEST CONDITIONS	T_A †	TLE2064M TLE2064AM TLE2064BM			UNIT
				MIN	TYP	MAX	
V_{IO}	Input offset voltage	$V_{IC} = 0, R_S = 50\ \Omega$	25°C	1.2	7	mV	
			Full range		9		
			25°C	1.2	6		
			Full range		8		
			25°C	0.8	3.5		
			Full range		5.5		
α_{VIO}	Temperature coefficient of input offset voltage	$V_{IC} = 0, R_S = 50\ \Omega$	25°C	6		$\mu\text{V}/^\circ\text{C}$	
	Input offset voltage long-term drift (see Note 4)		Full range	0.04		$\mu\text{V}/\text{mo}$	
I_{IO}	Input offset current	$V_{IC} = 0, R_S = 50\ \Omega$	25°C	1		pA	
			Full range		15	nA	
I_{IB}	Input bias current	$V_{IC} = 0, R_S = 50\ \Omega$	25°C	3		pA	
			Full range		30	nA	
V_{ICR}	Common-mode input voltage range		25°C	-1.6 to 4	-2 to 6	V	
			Full range	-1.6 to 4		V	
V_{OM+}	Maximum positive peak output voltage swing	$R_L = 10\ \text{k}\Omega$	25°C	3.5	3.7	V	
			Full range		3		
		FK and J packages	$R_L = 600\ \Omega$	25°C	2.5		3.6
				Full range			2
		D and N packages	$R_L = 100\ \Omega$	25°C	2.5		3.1
				Full range			2
V_{OM-}	Maximum negative peak output voltage swing	$R_L = 10\ \text{k}\Omega$	25°C	-3.5	-3.9	V	
			Full range		-3		
		FK and J packages	$R_L = 600\ \Omega$	25°C	-2.5		-3.5
				Full range			-2
		D and N packages	$R_L = 100\ \Omega$	25°C	-2.5		-2.7
				Full range			-2
A_{VD}	Large-signal differential voltage amplification	$V_O = \pm 2.8\ \text{V}, R_L = 10\ \text{k}\Omega$	25°C	15	80	V/mV	
			Full range		2		
		FK and J packages	$V_O = 0\ \text{to}\ 2.5\ \text{V}, R_L = 600\ \Omega$	25°C	1		65
				Full range			0.5
			$V_O = 0\ \text{to}\ -2.5\ \text{V}, R_L = 600\ \Omega$	25°C	1		16
				Full range			0.5

† Full range is -55°C to 125°C.

NOTE 4: Typical values are based on the input offset voltage shift observed through 168 hours of operating life test at $T_A = 150^\circ\text{C}$ extrapolated to $T_A = 25^\circ\text{C}$ using the Arrhenius equation and assuming an activation energy of 0.96 eV.

TLE206x, TLE206xA, TLE206xB
EXCALIBUR JFET-INPUT HIGH-OUTPUT-DRIVE
μPOWER OPERATIONAL AMPLIFIERS

SLOS193B – FEBRUARY 1997 – REVISED MAY 2004

TLE2064M electrical characteristics at specified free-air temperature, $V_{CC\pm} = \pm 5\text{ V}$ (unless otherwise noted) continued)

PARAMETER		TEST CONDITIONS	T_A^\dagger	TLE2064M TLE2064AM TLE2064BM			UNIT
				MIN	TYP	MAX	
A_{VD}	Large-signal differential voltage amplification	D and N packages	$V_O = 0$ to 2 V , $R_L = 100\ \Omega$	25°C	0.75	45	V/mV
				Full range	0.25		
		$V_O = 0$ to -2 V , $R_L = 100\ \Omega$	25°C	0.4	3		
			Full range	0.15			
r_i	Input resistance		25°C	10 ¹²		Ω	
c_i	Input capacitance		25°C	4		pF	
z_o	Open-loop output impedance	$I_O = 0$	25°C	560		Ω	
CMRR	Common-mode rejection ratio	$V_{IC} = V_{ICRmin}$, $R_S = 50\ \Omega$	25°C	65	82	dB	
			Full range	60			
k_{SVR}	Supply-voltage rejection ratio ($\Delta V_{CC\pm} / \Delta V_{IO}$)	$V_{CC\pm} = \pm 5\text{ V}$ to $\pm 15\text{ V}$, $R_S = 50\ \Omega$	25°C	75	93	dB	
			Full range	65			
I_{CC}	Supply current (four amplifiers)	$V_O = 0$, No load	25°C	1.12	1.3	mA	
			Full range	1.3			
ΔI_{CC}	Supply-current change over operating temperature range (four amplifiers)		Full range	144		μA	
V_{O1}/V_{O2}	Crosstalk attenuation	$A_{VD} = 1000$, $f = 1\text{ kHz}$	25°C	120		dB	

† Full range is -55°C to 125°C .

TLE2064M operating characteristics, $V_{CC\pm} = \pm 5\text{ V}$, $T_A = 25^\circ\text{C}$

PARAMETER		TEST CONDITIONS	TLE2064M TLE2064AM TLE2064BM			UNIT
			MIN	TYP	MAX	
SR	Slew rate at unity gain (see Figure 1)	$R_L = 10\text{ k}\Omega$, $C_L = 100\text{ pF}$	3.4			V/ μs
V_n	Equivalent input noise voltage (see Figure 2)	$f = 10\text{ Hz}$, $R_S = 20\ \Omega$	59			nV/ $\sqrt{\text{Hz}}$
		$f = 1\text{ kHz}$, $R_S = 20\ \Omega$	43			
$V_{N(PP)}$	Peak-to-peak equivalent input noise voltage	$f = 0.1\text{ Hz}$ to 10 Hz	1.1			μV
I_n	Equivalent input noise current	$f = 1\text{ kHz}$	1			fA/ $\sqrt{\text{Hz}}$
THD	Total harmonic distortion	$A_{VD} = 2$, $f = 10\text{ kHz}$, $V_{O(PP)} = 2\text{ V}$, $R_L = 10\text{ k}\Omega$	0.025%			
B_1	Unity-gain bandwidth (see Figure 3)	$R_L = 10\text{ k}\Omega$, $C_L = 100\text{ pF}$	1.8			MHz
		$R_L = 600\ \Omega$, $C_L = 100\text{ pF}$	1.3			
t_s	Settling time	$\epsilon = 0.1\%$	5			μs
		$\epsilon = 0.01\%$	10			
B_{OM}	Maximum output-swing bandwidth	$A_{VD} = 1$, $R_L = 10\text{ k}\Omega$	140			kHz
ϕ_m	Phase margin at unity gain (see Figure 3)	$R_L = 10\text{ k}\Omega$, $C_L = 100\text{ pF}$	58°			
		$R_L = 600\ \Omega$, $C_L = 100\text{ pF}$	75°			



TLE206x, TLE206xA, TLE206xB
EXCALIBUR JFET-INPUT HIGH-OUTPUT-DRIVE
μPOWER OPERATIONAL AMPLIFIERS

SLOS193B – FEBRUARY 1997 – REVISED MAY 2004

TLE2064M electrical characteristics at specified free-air temperature, $V_{CC\pm} = \pm 15\text{ V}$ (unless otherwise noted)

PARAMETER		TEST CONDITIONS	T_A †	TLE2064M TLE2064AM TLE2064BM			UNIT
				MIN	TYP	MAX	
V_{IO}	Input offset voltage	$V_{IC} = 0, R_S = 50\ \Omega$	25°C	0.9	6	mV	
			Full range		8		
			25°C	0.9	4		
			Full range		6		
			25°C	0.7	2		
			Full range		4		
α_{VIO}	Temperature coefficient of input offset voltage	$V_{IC} = 0, R_S = 50\ \Omega$	25°C	6		$\mu\text{V}/^\circ\text{C}$	
	Input offset voltage long-term drift (see Note 4)		Full range	0.04		$\mu\text{V}/\text{mo}$	
I_{IO}	Input offset current		25°C	2		pA	
			Full range		20	nA	
I_{IB}	Input bias current		25°C	4		pA	
			Full range		40	nA	
V_{ICR}	Common-mode input voltage range		25°C	-11 to 13	-12 to 16	V	
			Full range	-11 to 13		V	
V_{OM+}	Maximum positive peak output voltage swing	$R_L = 10\ \text{k}\Omega$	25°C	13	13.7	V	
			Full range	12.5			
		$R_L = 600\ \Omega$	25°C	12.5	13.2		
			Full range	12			
V_{OM-}	Maximum negative peak output voltage swing	$R_L = 10\ \text{k}\Omega$	25°C	-13	-13.7	V	
			Full range	-12.5			
		$R_L = 600\ \Omega$	25°C	-13	-13		
			Full range	-12.5			
A_{VD}	Large-signal differential voltage amplification	$V_O = \pm 10\ \text{V}, R_L = 10\ \text{k}\Omega$	25°C	30	230	V/mV	
			Full range	20			
		$V_O = 0\ \text{to}\ 8\ \text{V}, R_L = 600\ \Omega$	25°C	25	100		
			Full range	7			
		$V_O = 0\ \text{to}\ -8\ \text{V}, R_L = 600\ \Omega$	25°C	3	25		
			Full range	1			
r_i	Input resistance		25°C	10^{12}	Ω		
c_i	Input capacitance		25°C	4	pF		
z_o	Open-loop output impedance	$I_O = 0$	25°C	560	Ω		
CMRR	Common-mode rejection ratio	$V_{IC} = V_{ICRmin}, R_S = 50\ \Omega$	25°C	72	90	dB	
			Full range	65			
k_{SVR}	Supply-voltage rejection ratio ($\Delta V_{CC\pm} / \Delta V_{IO}$)	$V_{CC\pm} = \pm 5\ \text{V to } \pm 15\ \text{V}, R_S = 50\ \Omega$	25°C	75	93	dB	
			Full range	65			

† Full range is -55°C to 125°C.

NOTE 4: Typical values are based on the input offset voltage shift observed through 168 hours of operating life test at $T_A = 150^\circ\text{C}$ extrapolated to $T_A = 25^\circ\text{C}$ using the Arrhenius equation and assuming an activation energy of 0.96 eV.



TLE206x, TLE206xA, TLE206xB
EXCALIBUR JFET-INPUT HIGH-OUTPUT-DRIVE
μPOWER OPERATIONAL AMPLIFIERS

SLOS193B – FEBRUARY 1997 – REVISED MAY 2004

TLE2064M electrical characteristics at specified free-air temperature, $V_{CC\pm} = \pm 15$ V (unless otherwise noted) (continued)

PARAMETER	TEST CONDITIONS	T_A †	TLE2064M TLE2064AM TLE2064BM			UNIT
			MIN	TYP	MAX	
I_{CC} Supply current (four amplifiers)	$V_O = 0$, No load	25°C		1.25	1.4	mA
		Full range			1.5	
ΔI_{CC} Supply-current change over operating temperature range (four amplifiers)		Full range		194		μA
V_{O1}/V_{O2} Crosstalk attenuation	$A_{VD} = 1000$, $f = 1$ kHz	25°C		120		dB

† Full range is – 55°C to 125°C.

TLE2064M operating characteristics at specified free-air temperature, $V_{CC\pm} = \pm 15$ V

PARAMETER	TEST CONDITIONS	T_A †	TLE2064M TLE2064AM TLE2064BM			UNIT
			MIN	TYP	MAX	
SR Slew rate at unity gain (see Figure 1)	$R_L = 10$ kΩ, $C_L = 100$ pF	25°C	2.6	3.4		V/μs
		Full range	1.8			
V_n Equivalent input noise voltage (see Figure 2)	$f = 10$ Hz, $R_S = 20$ Ω	25°C		70		nV/√Hz
	$f = 1$ kHz, $R_S = 20$ Ω			40		
$V_{N(PP)}$ Peak-to-peak equivalent input noise voltage	$f = 0.1$ Hz to 10 Hz	25°C		1.1		μV
I_n Equivalent input noise current	$f = 1$ kHz	25°C		1.1		fA/√Hz
THD Total harmonic distortion	$A_{VD} = 2$, $f = 10$ kHz, $V_{O(PP)} = 2$ V, $R_L = 10$ kΩ	25°C		0.025%		
B_1 Unity-gain bandwidth (see Figure 3)	$R_L = 10$ kΩ, $C_L = 100$ pF	25°C		2		MHz
	$R_L = 600$ Ω, $C_L = 100$ pF			1.5		
t_s Settling time	$\epsilon = 0.1\%$	25°C		5		μs
	$\epsilon = 0.01\%$			10		
B_{OM} Maximum output-swing bandwidth	$A_{VD} = 1$, $R_L = 10$ kΩ	25°C		40		kHz
ϕ_m Phase margin at unity gain (see Figure 3)	$R_L = 10$ kΩ, $C_L = 100$ pF	25°C		60°		
	$R_L = 600$ Ω, $C_L = 100$ pF			70°		

† Full range is – 55°C to 125°C.

TLE206x, TLE206xA, TLE206xB EXCALIBUR JFET-INPUT HIGH-OUTPUT-DRIVE μPOWER OPERATIONAL AMPLIFIERS

SLOS193B – FEBRUARY 1997 – REVISED MAY 2004

TLE2064Y electrical characteristics at $V_{CC\pm} = \pm 15\text{ V}$, $T_A = 25^\circ\text{C}$ (unless otherwise noted)

PARAMETER	TEST CONDITIONS	TLE2064Y			UNIT
		MIN	TYP	MAX	
V_{IO} Input offset voltage	$V_{IC} = 0$, $R_S = 50\ \Omega$		0.9	6	mV
∞V_{IO} Input offset voltage long-term drift (see Note 4)			0.04		$\mu\text{V}/\text{mo}$
I_{IO} Input offset current			2		pA
I_{IB} Input bias current			4		pA
V_{ICR} Common-mode input voltage range		-11 to 13	-12 to 16		V
V_{OM+} Maximum positive peak output voltage swing	$R_L = 10\ \text{k}\Omega$	13.2	13.7		V
	$R_L = 600\ \Omega$	12.5	13.2		
V_{OM-} Maximum negative peak output voltage swing	$R_L = 10\ \text{k}\Omega$	-13.2	-13.7		V
	$R_L = 600\ \Omega$	12.5	13		V
A_{VD} Large-signal differential voltage amplification	$V_O = \pm 10\ \text{V}$, $R_L = 10\ \text{k}\Omega$	30	230		V/mV
	$V_O = 0\ \text{to}\ 8\ \text{V}$, $R_L = 600\ \Omega$	25	100		
	$V_O = 0\ \text{to}\ -8\ \text{V}$, $R_L = 600\ \Omega$	3	25		
r_i Input resistance			10^{12}		Ω
c_i Input capacitance			4		pF
z_o Open-loop output impedance	$I_O = 0$		560		Ω
CMRR Common-mode rejection ratio	$R_S = 50\ \Omega$, $V_{IC} = V_{ICR\text{min}}$	72	90		dB
k_{SVR} Supply-voltage rejection ratio ($\Delta V_{CC\pm} / \Delta V_{IO}$)	$V_{CC\pm} = \pm 5\ \text{V}\ \text{to}\ \pm 15\ \text{V}$, $R_S = 50\ \Omega$	75	93		dB
I_{CC} Supply current	$V_O = 0$, No load		1.25	1.4	mA
V_{O1}/V_{O2} Crosstalk attenuation	$A_{VD} = 1000$, $f = 1\ \text{kHz}$		120		dB

NOTE 4: Typical values are based on the input offset voltage shift observed through 168 hours of operating life test at $T_A = 150^\circ\text{C}$ extrapolated to $T_A = 25^\circ\text{C}$ using the Arrhenius equation and assuming an activation energy of 0.96 eV.

TLE2064Y operating characteristics at $V_{CC\pm} = \pm 15\ \text{V}$, $T_A = 25^\circ\text{C}$

PARAMETER	TEST CONDITIONS	TLE2064Y			UNIT
		MIN	TYP	MAX	
SR Slew rate at unity gain (see Figure 1)	$R_L = 10\ \text{k}\Omega$, $C_L = 100\ \text{pF}$	2.6	3.4		V/ μs
V_n Equivalent input noise voltage (see Figure 2)	$f = 10\ \text{Hz}$, $R_S = 20\ \Omega$		70		nV/ $\sqrt{\text{Hz}}$
	$f = 1\ \text{kHz}$, $R_S = 20\ \Omega$		40		
$V_{N(PP)}$ Peak-to-peak equivalent input noise voltage	$f = 0.1\ \text{Hz}\ \text{to}\ 10\ \text{Hz}$		1.1		μV
I_n Equivalent input noise current	$f = 1\ \text{kHz}$		1.1		fA/ $\sqrt{\text{Hz}}$
THD Total harmonic distortion	$A_{VD} = 2$, $f = 10\ \text{kHz}$, $V_{O(PP)} = 2\ \text{V}$, $R_L = 10\ \text{k}\Omega$		0.025%		
B_1 Unity-gain bandwidth (see Figure 3)	$R_L = 10\ \text{k}\Omega$, $C_L = 100\ \text{pF}$		2		MHz
	$R_L = 600\ \Omega$, $C_L = 100\ \text{pF}$		1.5		
t_s Settling time	$\epsilon = 0.1\%$		5		μs
	$\epsilon = 0.01\%$		10		
BOM Maximum output-swing bandwidth	$A_{VD} = 1$, $R_L = 10\ \text{k}\Omega$		40		kHz
ϕ_m Phase margin at unity gain (see Figure 3)	$R_L = 10\ \text{k}\Omega$, $C_L = 100\ \text{pF}$		60°		
	$R_L = 600\ \Omega$, $C_L = 100\ \text{pF}$		70°		



PARAMETER MEASUREMENT INFORMATION



NOTE A: C_L includes fixture capacitance.

Figure 1. Slew-Rate Test Circuit

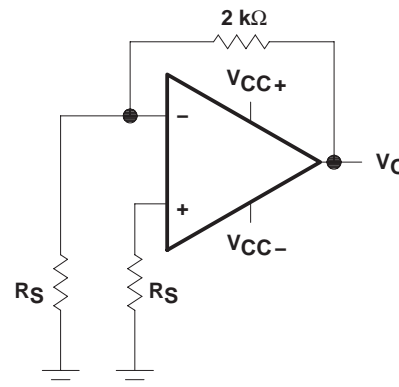

Figure 2. Noise-Voltage Test Circuit



NOTE A: C_L includes fixture capacitance.

Figure 3. Unity-Gain Bandwidth and Phase-Margin Test Circuit

typical values

Typical values presented in this data sheet represent the median (50% point) of device parametric performance.

input bias and offset current

At the picoampere bias current level typical of the TLE206x, TLE2064xA, and TLE206xB, accurate measurement of the bias current becomes difficult. Not only does this measurement require a picoammeter, but test socket leakages can easily exceed the actual device bias currents. To accurately measure these small currents, Texas Instruments uses a two-step process. The socket leakage is measured using picoammeters with bias voltages applied but with no device in the socket. The device is then inserted into the socket and a second test that measures both the socket leakage and the device input bias current is performed. The two measurements are then subtracted algebraically to determine the bias current of the device.

TLE206x, TLE206xA, TLE206xB
EXCALIBUR JFET-INPUT HIGH-OUTPUT-DRIVE
μPOWER OPERATIONAL AMPLIFIERS

SLOS193B – FEBRUARY 1997 – REVISED MAY 2004

TYPICAL CHARACTERISTICS

Table of Graphs

		FIGURE	
V_{IO}	Input offset voltage	Distribution	4, 5, 6
I_{IB}	Input bias current	vs Common-mode input voltage	7
		vs Free-air temperature	8
I_{IO}	Input offset current	vs Free-air temperature	8
V_{ICR}	Common-mode input voltage	vs Free-air temperature	9
V_{OM}	Maximum peak output voltage	vs Output current	10, 11
		vs Supply voltage	12, 13, 14
$V_{O(PP)}$	Maximum peak-to-peak output voltage	vs Frequency	15, 16
		vs Load resistance	17
A_{VD}	Large-signal differential voltage amplification	vs Frequency	18
		vs Free-air temperature	19
I_{OS}	Short-circuit output current	vs Elapsed time	20
		vs Free-air temperature	21
Z_o	Output impedance	vs Frequency	22, 23
$CMRR$	Common-mode rejection ratio	vs Frequency	24
I_{CC}	Supply current	vs Supply voltage	25, 26, 27
		vs Free-air temperature	28, 29, 30
	Voltage-follower small-signal pulse response	vs Time	31, 32
	Voltage-follower large-signal pulse response	vs Time	33, 34
	Noise voltage (referred to input)	0.1 to 10 Hz	35
V_n	Equivalent input noise voltage	vs Frequency	36
THD	Total harmonic distortion	vs Frequency	37, 38
B_1	Unity-gain bandwidth	vs Supply voltage	39
		vs Free-air temperature	40
ϕ_m	Phase margin	vs Supply voltage	41
		vs Load capacitance	42
		vs Free-air temperature	43
	Phase shift	vs Frequency	18

TYPICAL CHARACTERISTICS

TLE2061
 DISTRIBUTION OF
 INPUT OFFSET VOLTAGE

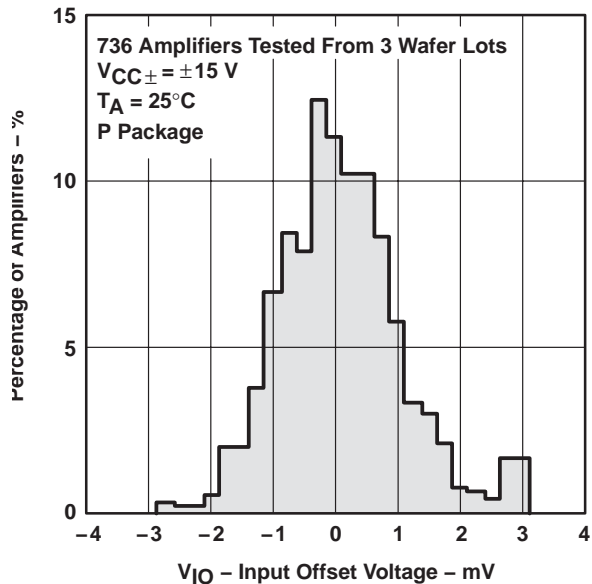

Figure 4

TLE2062
 DISTRIBUTION OF
 INPUT OFFSET VOLTAGE



Figure 5

TLE2064
 DISTRIBUTION OF
 INPUT OFFSET VOLTAGE

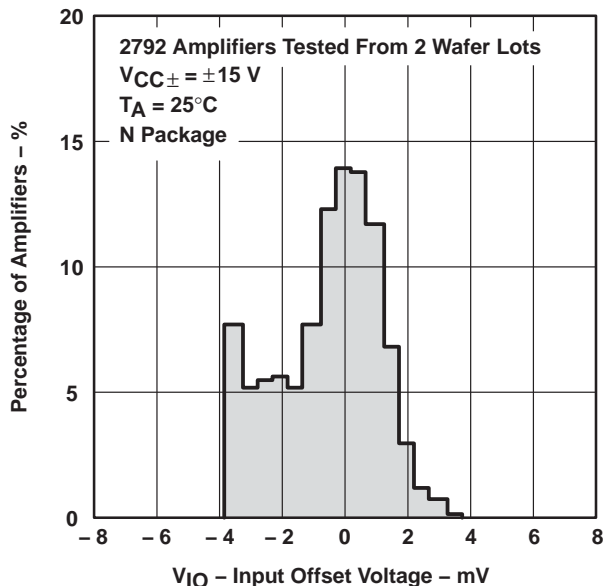

Figure 6

INPUT BIAS CURRENT
 vs
 COMMON-MODE INPUT VOLTAGE



Figure 7

TLE206x, TLE206xA, TLE206xB
EXCALIBUR JFET-INPUT HIGH-OUTPUT-DRIVE
μPOWER OPERATIONAL AMPLIFIERS

SLOS193B – FEBRUARY 1997 – REVISED MAY 2004

TYPICAL CHARACTERISTICS†

**INPUT BIAS CURRENT
 AND INPUT OFFSET CURRENT
 vs
 FREE-AIR TEMPERATURE**

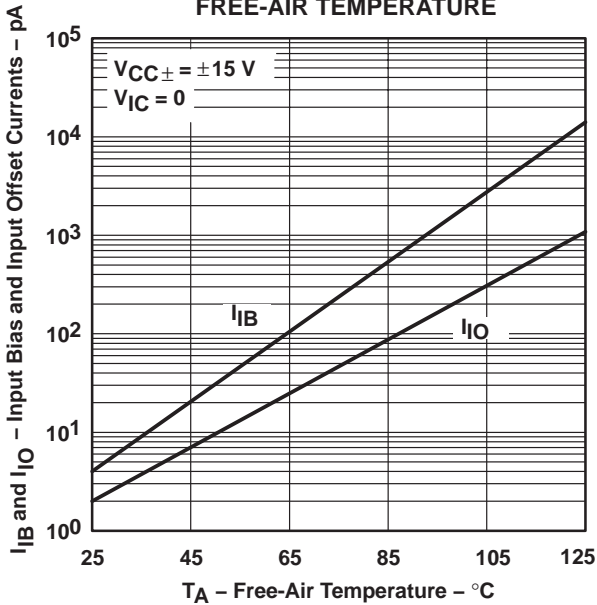

Figure 8

**COMMON-MODE INPUT VOLTAGE
 vs
 FREE-AIR TEMPERATURE**

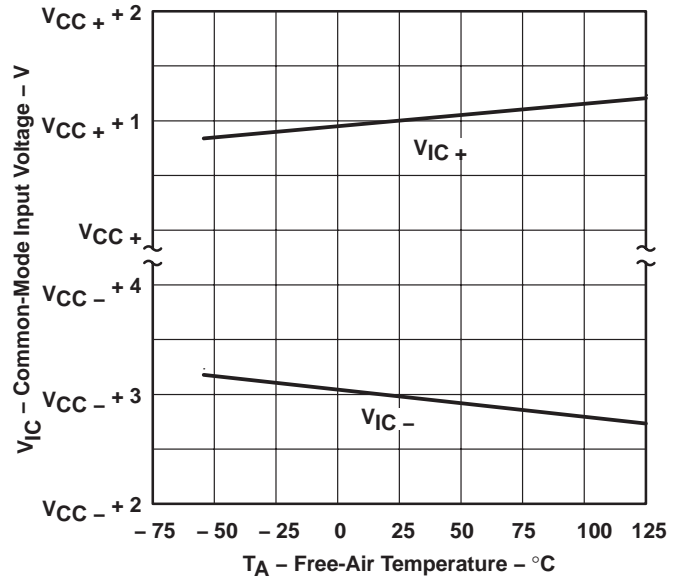

Figure 9

**MAXIMUM POSITIVE PEAK
 OUTPUT VOLTAGE
 vs
 OUTPUT CURRENT**

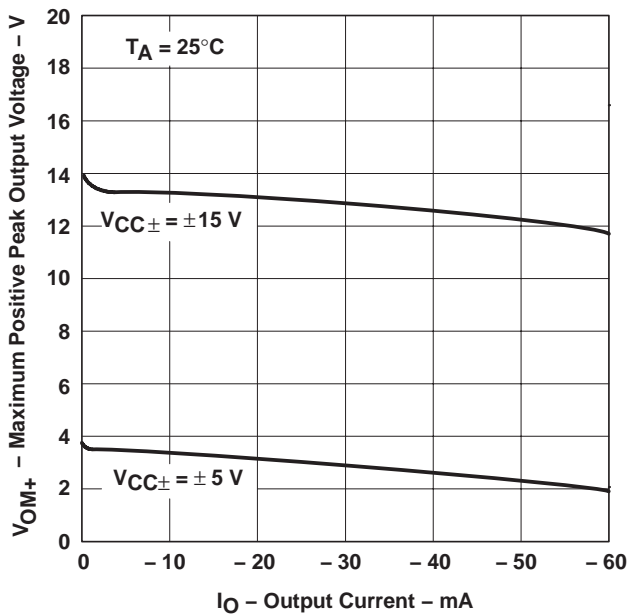

Figure 10

**MAXIMUM NEGATIVE PEAK
 OUTPUT VOLTAGE
 vs
 OUTPUT CURRENT**

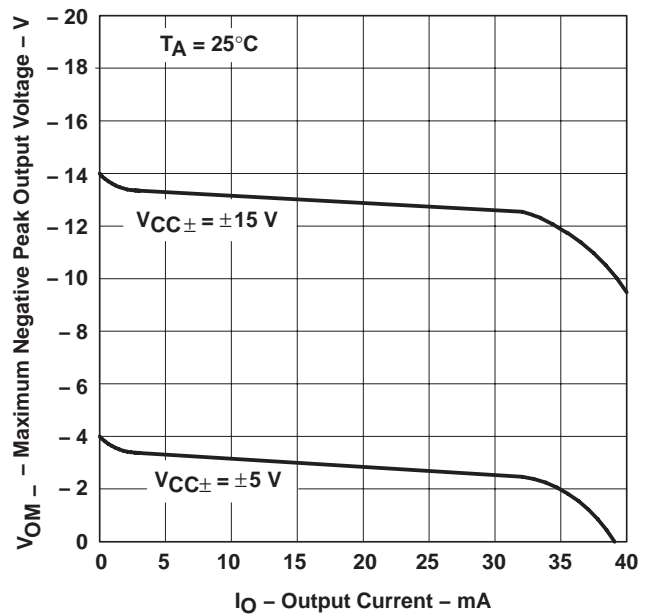

Figure 11

† Data at high and low temperatures are applicable only within the rated operating free-air temperature ranges of the various devices.

TYPICAL CHARACTERISTICS

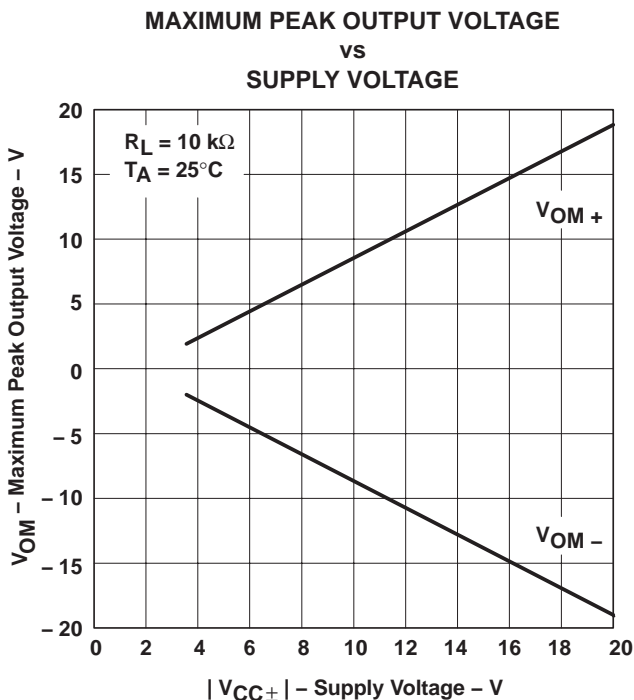

Figure 12

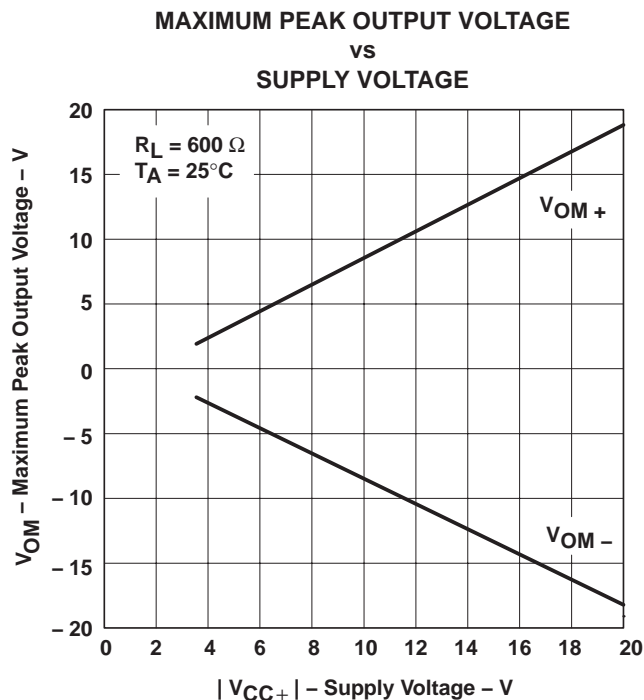

Figure 13



Figure 14

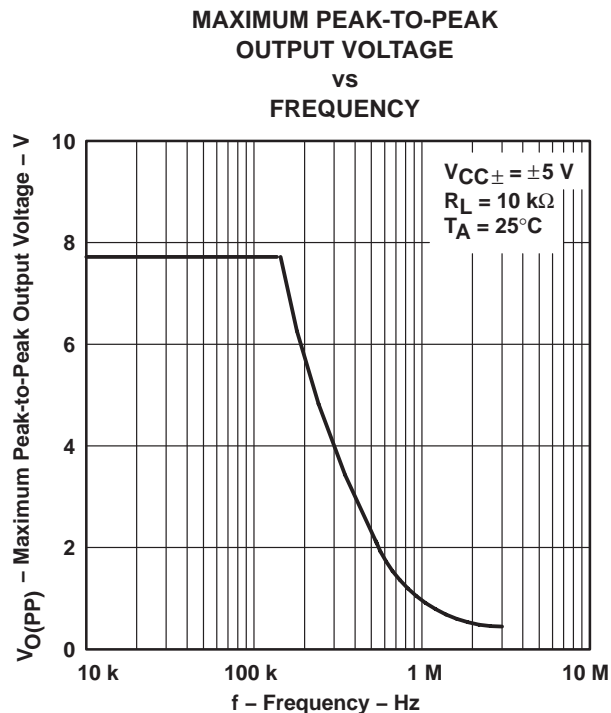

Figure 15

TLE206x, TLE206xA, TLE206xB
EXCALIBUR JFET-INPUT HIGH-OUTPUT-DRIVE
μPOWER OPERATIONAL AMPLIFIERS

SLOS193B – FEBRUARY 1997 – REVISED MAY 2004

TYPICAL CHARACTERISTICS†

**MAXIMUM PEAK-TO-PEAK
 OUTPUT VOLTAGE
 vs
 FREQUENCY**



Figure 16

**MAXIMUM PEAK-TO-PEAK
 OUTPUT VOLTAGE
 vs
 LOAD RESISTANCE**

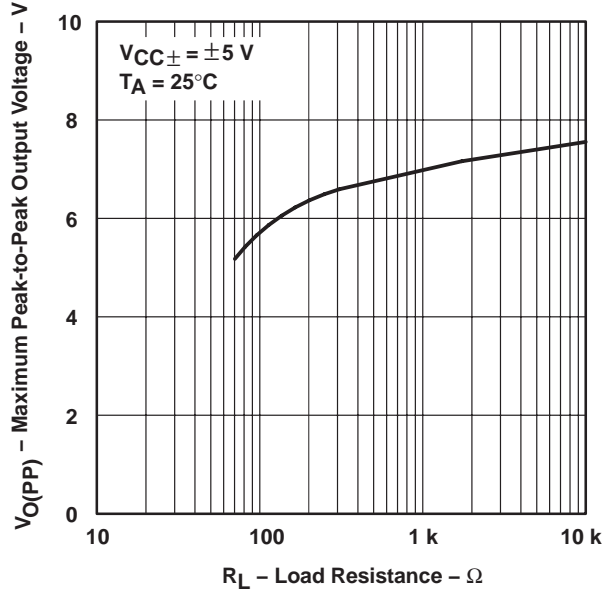

Figure 17

**LARGE-SIGNAL DIFFERENTIAL VOLTAGE
 AMPLIFICATION AND PHASE SHIFT
 vs
 FREQUENCY**



Figure 18

**LARGE-SIGNAL VOLTAGE AMPLIFICATION
 vs
 FREE-AIR TEMPERATURE**

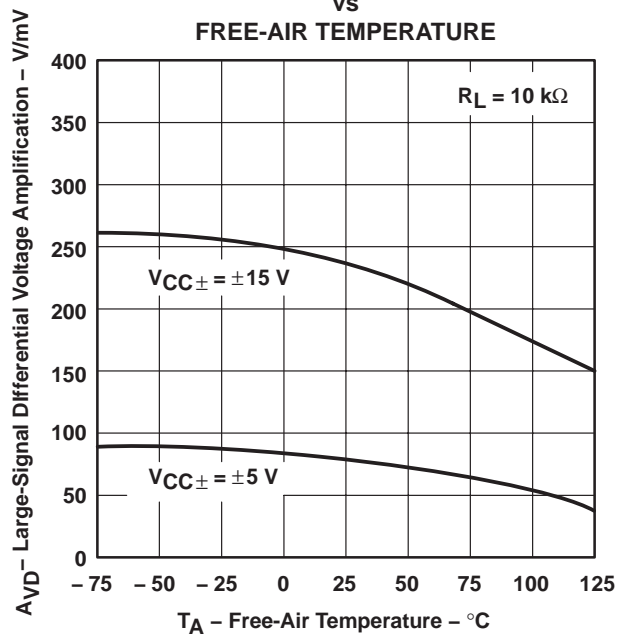

Figure 19

† Data at high and low temperatures are applicable only within the rated operating free-air temperature ranges of the various devices.

TYPICAL CHARACTERISTICS†



Figure 20



Figure 21



Figure 22

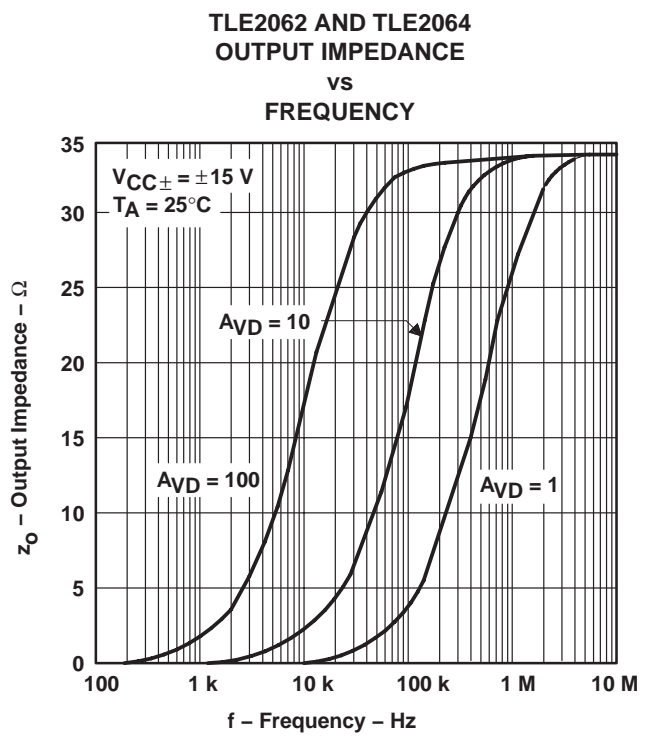

Figure 23

† Data at high and low temperatures are applicable only within the rated operating free-air temperature ranges of the various devices.

TLE206x, TLE206xA, TLE206xB
EXCALIBUR JFET-INPUT HIGH-OUTPUT-DRIVE
μPOWER OPERATIONAL AMPLIFIERS

SLOS193B – FEBRUARY 1997 – REVISED MAY 2004

TYPICAL CHARACTERISTICS†

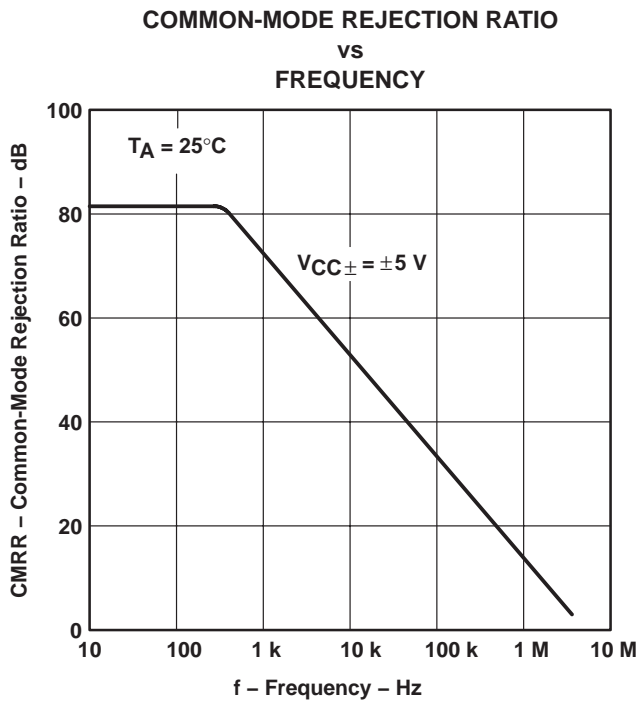

Figure 24

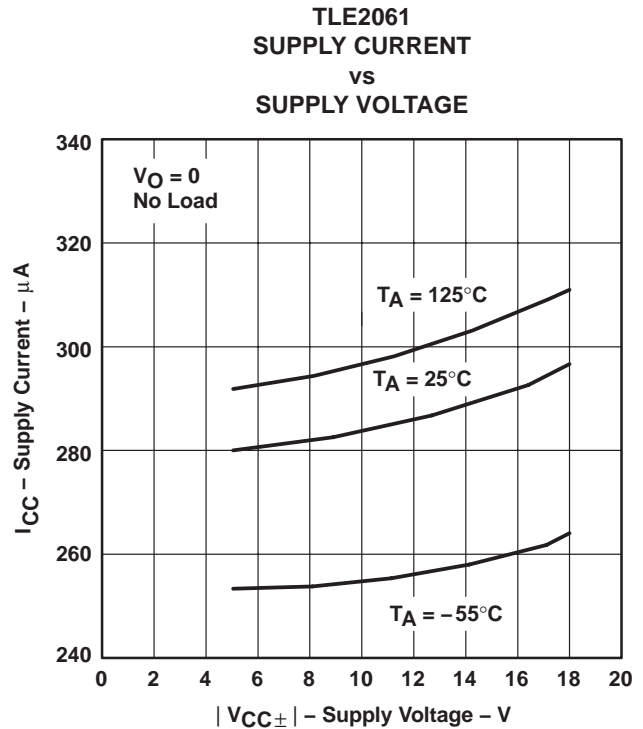

Figure 25

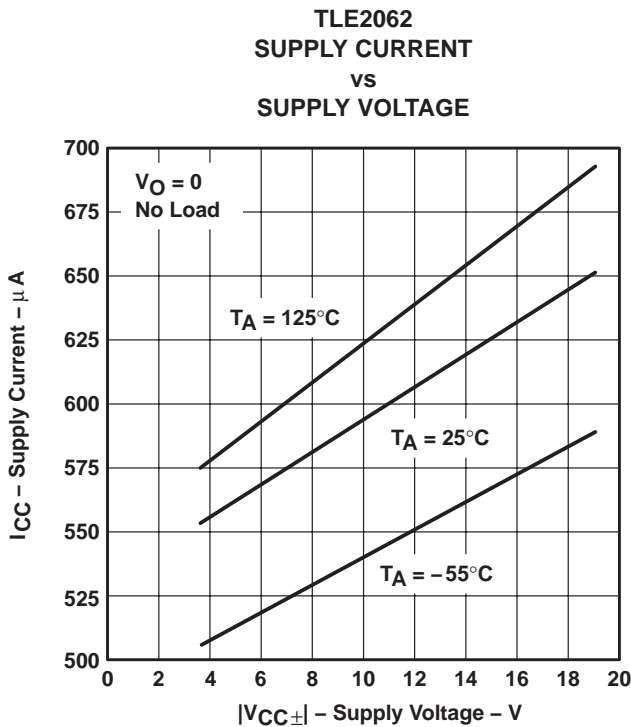

Figure 26

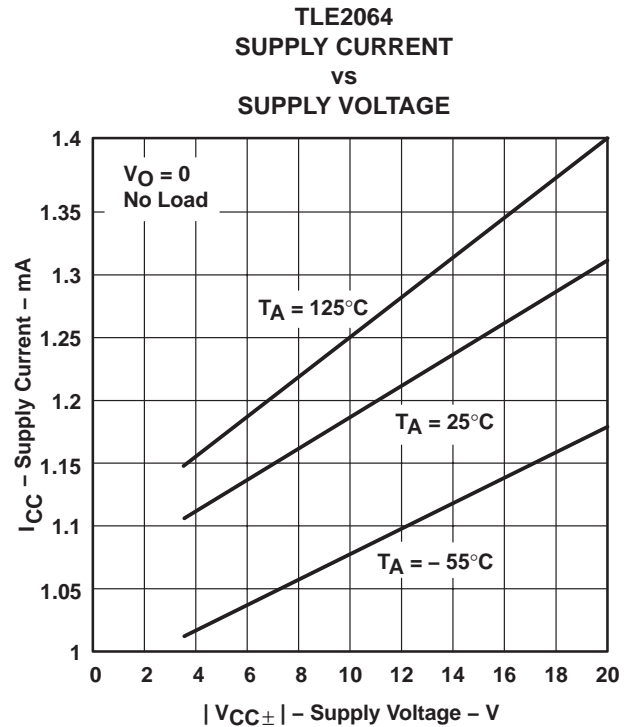
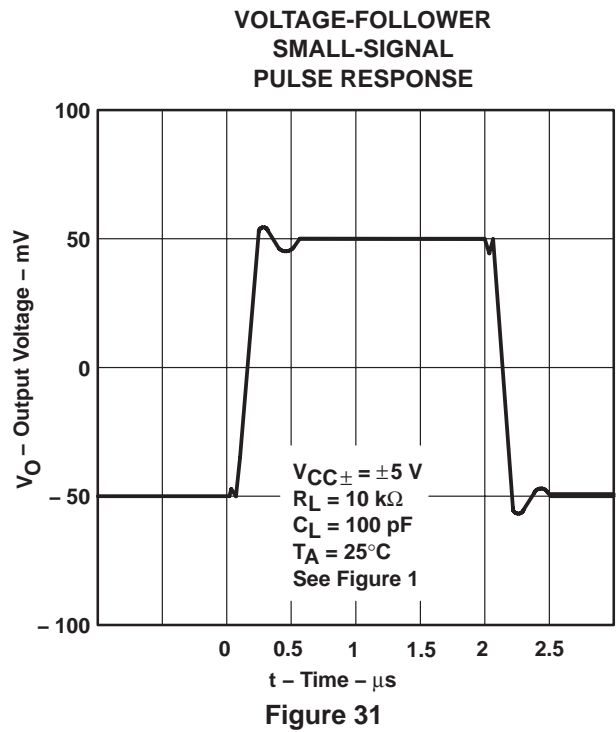
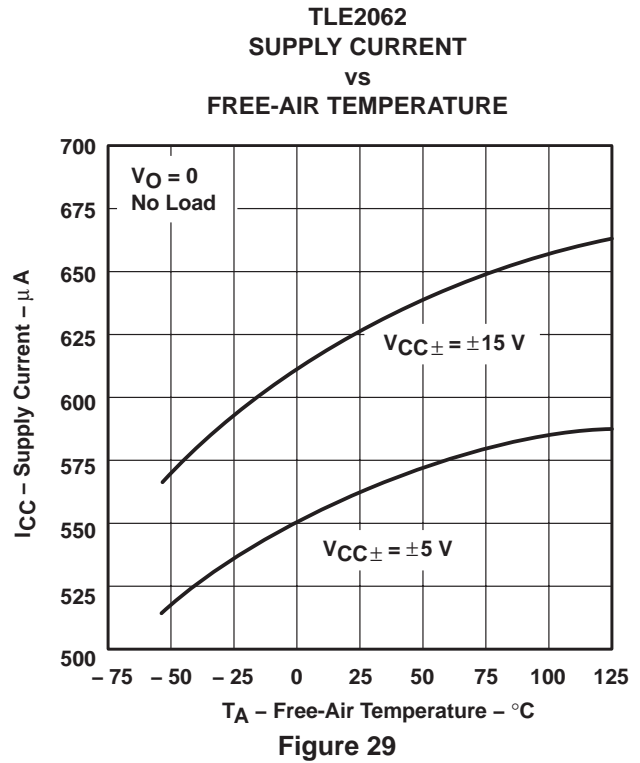

Figure 27

† Data at high and low temperatures are applicable only within the rated operating free-air temperature ranges of the various devices.



TYPICAL CHARACTERISTICS†



† Data at high and low temperatures are applicable only within the rated operating free-air temperature ranges of the various devices.

TYPICAL CHARACTERISTICS

**VOLTAGE-FOLLOWER
 SMALL-SIGNAL
 PULSE RESPONSE**



Figure 32

**VOLTAGE-FOLLOWER
 LARGE-SIGNAL
 PULSE RESPONSE**



Figure 33

**VOLTAGE-FOLLOWER
 LARGE-SIGNAL
 PULSE RESPONSE**



Figure 34

**NOISE VOLTAGE
 (REFERRED TO INPUT)
 0.1 TO 10 Hz**

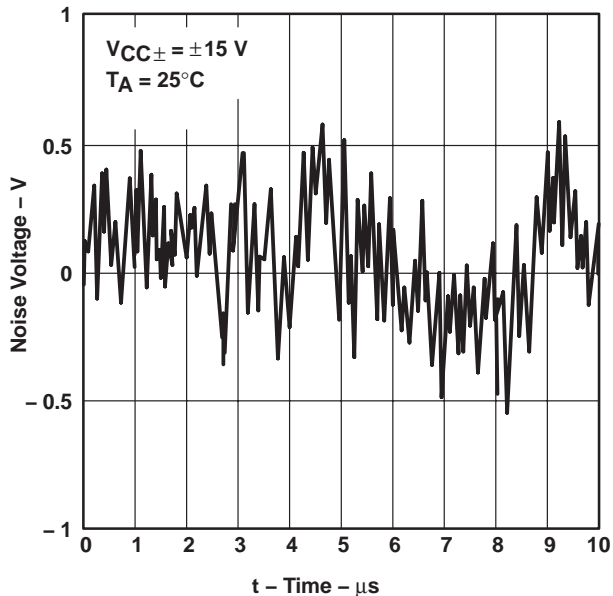

Figure 35

TYPICAL CHARACTERISTICS

EQUIVALENT INPUT NOISE VOLTAGE
 vs
 FREQUENCY

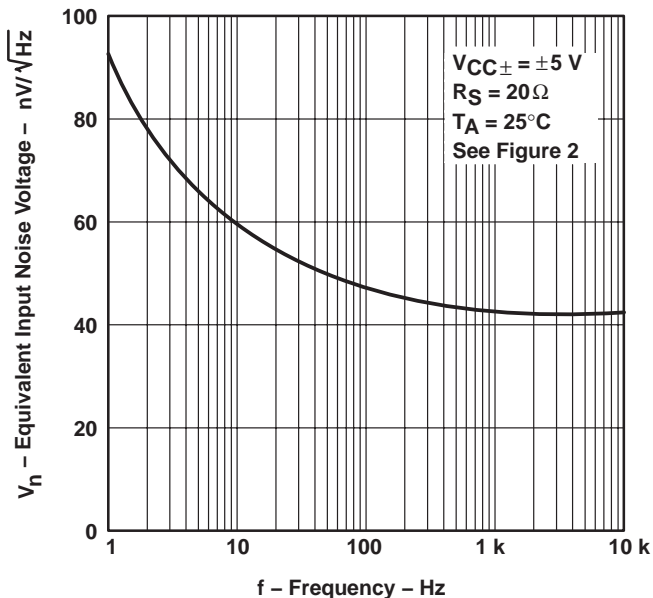

Figure 36

TOTAL HARMONIC DISTORTION
 vs
 FREQUENCY

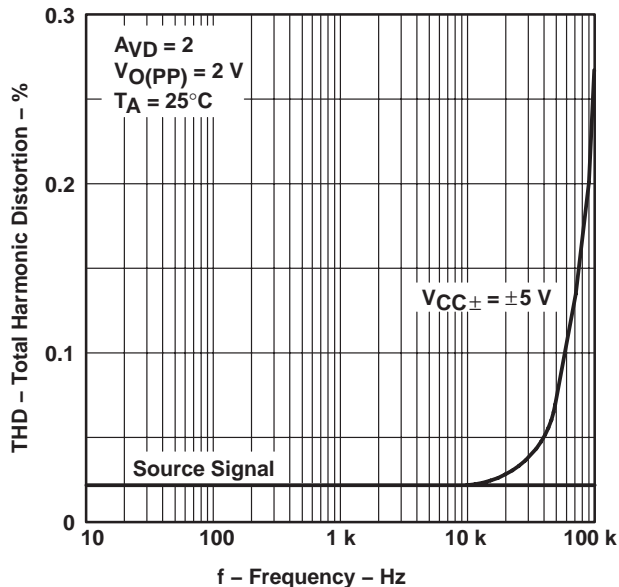

Figure 37

TOTAL HARMONIC DISTORTION
 vs
 FREQUENCY

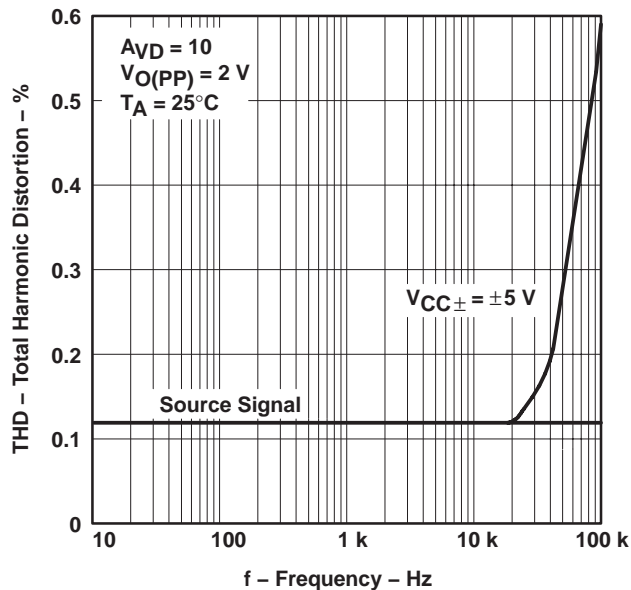

Figure 38

UNITY-GAIN BANDWIDTH
 vs
 SUPPLY VOLTAGE

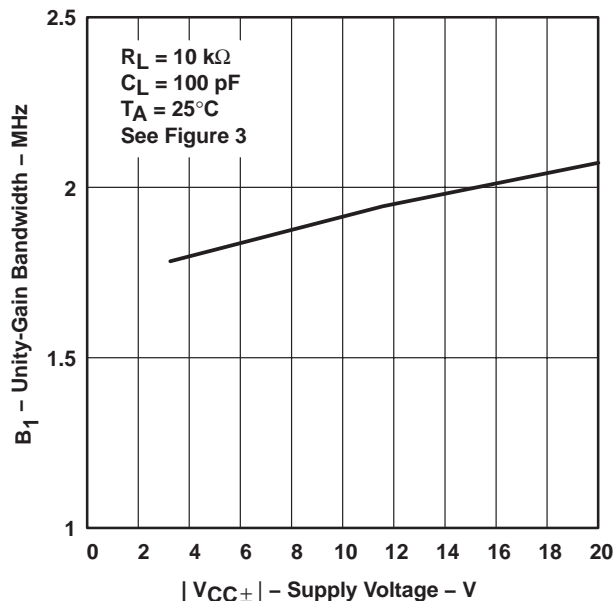

Figure 39

TLE206x, TLE206xA, TLE206xB
EXCALIBUR JFET-INPUT HIGH-OUTPUT-DRIVE
μPOWER OPERATIONAL AMPLIFIERS

SLOS193B – FEBRUARY 1997 – REVISED MAY 2004

TYPICAL CHARACTERISTICS†

UNITY-GAIN BANDWIDTH
vs
FREE-AIR TEMPERATURE



Figure 40

PHASE MARGIN
vs
SUPPLY VOLTAGE



Figure 41

PHASE MARGIN
vs
LOAD CAPACITANCE



Figure 42

PHASE MARGIN
vs
FREE-AIR TEMPERATURE



Figure 43

† Data at high and low temperatures are applicable only within the rated operating free-air temperature ranges of the various devices.



APPLICATION INFORMATION

input characteristics

The TLE206x, TLE206xA, and TLE206xB are specified with a minimum and a maximum input voltage that if exceeded at either input could cause the device to malfunction. Because of the extremely high input impedance and resulting low bias current requirements, the TLE206x, TLE206xA, and TLE206xB are well suited for low-level signal processing. However, leakage currents on printed-circuit boards and sockets can easily exceed bias current requirements and cause degradation in system performance. It is good practice to include guard rings around inputs (see Figure 44). These guards should be driven from a low-impedance source at the same voltage level as the common-mode input.



Figure 44. Use of Guard Rings

TLE2061 input offset voltage nulling

The TLE2061 series offers external null pins that can be used to further reduce the input offset voltage. The circuit of Figure 45 can be connected as shown if the feature is desired. When external nulling is not needed, the null pins may be left unconnected.

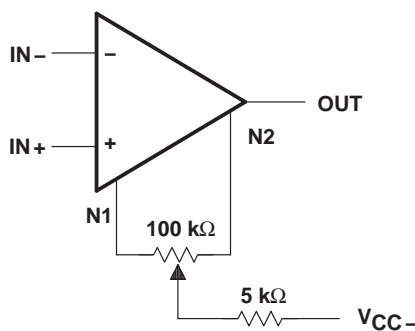

Figure 45. Input Offset Voltage Nulling

TLE206x, TLE206xA, TLE206xB EXCALIBUR JFET-INPUT HIGH-OUTPUT-DRIVE μPOWER OPERATIONAL AMPLIFIERS

SLOS193B – FEBRUARY 1997 – REVISED MAY 2004

APPLICATION INFORMATION

macromodel information

Macromodel information provided was derived using Microsim *Parts*[™], the model generation software used with Microsim *PSpice*[™]. The Boyle macromodel (see Note 5) and the subcircuit in Figure 46 were generated using the TLE206x typical electrical and operating characteristics at 25°C. Using this information, output simulations of the following key parameters can be generated to a tolerance of 20% (in most cases).

- Maximum positive output voltage swing
- Maximum negative output voltage swing
- Slew rate
- Quiescent power dissipation
- Input bias current
- Open-loop voltage amplification
- Unity-gain frequency
- Common-mode rejection ratio
- Phase margin
- DC output resistance
- AC output resistance
- Short-circuit output current limit

NOTE 5: G. R. Boyle, B. M. Cohn, D. O. Pederson, and J. E. Solomon, "Macromodeling of Integrated Circuit Operational Amplifiers", *IEEE Journal of Solid-State Circuits*, SC-9, 353 (1974).

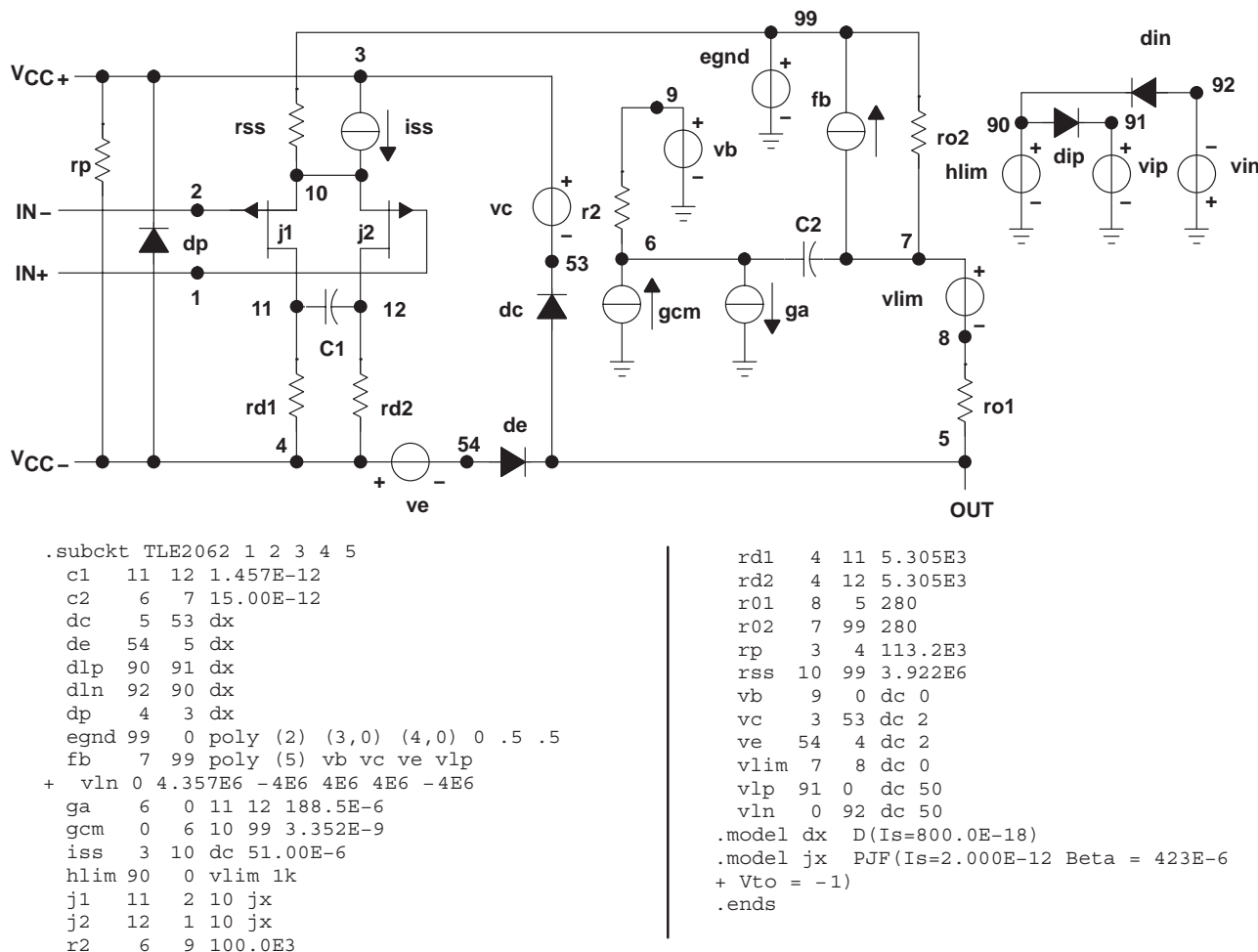

Figure 46. Boyle Macromodel and Subcircuit

PSpice and *Parts* are trademarks of MicroSim Corporation.



POST OFFICE BOX 655303 • DALLAS, TEXAS 75265

PACKAGING INFORMATION

Orderable Device	Status ⁽¹⁾	Package Type	Package Drawing	Pins	Package Qty	Eco Plan ⁽²⁾	Lead/ Ball Finish	MSL Peak Temp ⁽³⁾	Samples (Requires Login)
5962-9080701M2A	ACTIVE	LCCC	FK	20	1	TBD	Call TI	Call TI	
5962-9080701MHA	ACTIVE	CFP	U	10	1	TBD	Call TI	Call TI	
5962-9080701MPA	ACTIVE	CDIP	JG	8	1	TBD	Call TI	Call TI	
5962-9080702Q2A	ACTIVE	LCCC	FK	20	1	TBD	Call TI	Call TI	
5962-9080702QHA	ACTIVE	CFP	U	10	1	TBD	Call TI	Call TI	
5962-9080702QPA	ACTIVE	CDIP	JG	8	1	TBD	Call TI	Call TI	
5962-9080703QPA	ACTIVE	CDIP	JG	8	1	TBD	Call TI	Call TI	
5962-9080801M2A	ACTIVE	LCCC	FK	20	1	TBD	Call TI	Call TI	
5962-9080801MHA	ACTIVE	CFP	U	10	1	TBD	Call TI	Call TI	
5962-9080801MPA	ACTIVE	CDIP	JG	8	1	TBD	Call TI	Call TI	
5962-9080802Q2A	ACTIVE	LCCC	FK	20	1	TBD	Call TI	Call TI	
5962-9080802QHA	ACTIVE	CFP	U	10	1	TBD	Call TI	Call TI	
5962-9080802QPA	ACTIVE	CDIP	JG	8	1	TBD	Call TI	Call TI	
5962-9080803QPA	ACTIVE	CDIP	JG	8	1	TBD	Call TI	Call TI	
5962-9080901M2A	ACTIVE	LCCC	FK	20	1	TBD	Call TI	Call TI	
5962-9080901MCA	ACTIVE	CDIP	J	14	1	TBD	Call TI	Call TI	
5962-9080901MDA	ACTIVE	CFP	W	14	1	TBD	Call TI	Call TI	
5962-9080902M2A	ACTIVE	LCCC	FK	20	1	TBD	Call TI	Call TI	
5962-9080902MCA	ACTIVE	CDIP	J	14	1	TBD	Call TI	Call TI	
5962-9080902MDA	ACTIVE	CFP	W	14	1	TBD	Call TI	Call TI	
5962-9080903Q2A	ACTIVE	LCCC	FK	20	1	TBD	Call TI	Call TI	
5962-9080903QCA	ACTIVE	CDIP	J	14	1	TBD	Call TI	Call TI	
TLE2061ACD	ACTIVE	SOIC	D	8	75	Green (RoHS & no Sb/Br)	CU NIPDAU	Level-1-260C-UNLIM	
TLE2061ACDG4	ACTIVE	SOIC	D	8	75	Green (RoHS & no Sb/Br)	CU NIPDAU	Level-1-260C-UNLIM	
TLE2061ACP	ACTIVE	PDIP	P	8	50	Pb-Free (RoHS)	CU NIPDAU	N / A for Pkg Type	
TLE2061ACPE4	ACTIVE	PDIP	P	8	50	Pb-Free (RoHS)	CU NIPDAU	N / A for Pkg Type	
TLE2061AID	ACTIVE	SOIC	D	8	75	Green (RoHS & no Sb/Br)	CU NIPDAU	Level-1-260C-UNLIM	

Orderable Device	Status ⁽¹⁾	Package Type	Package Drawing	Pins	Package Qty	Eco Plan ⁽²⁾	Lead/ Ball Finish	MSL Peak Temp ⁽³⁾	Samples (Requires Login)
TLE2061AIDG4	ACTIVE	SOIC	D	8	75	Green (RoHS & no Sb/Br)	CU NIPDAU	Level-1-260C-UNLIM	
TLE2061AIP	ACTIVE	PDIP	P	8	50	Pb-Free (RoHS)	CU NIPDAU	N / A for Pkg Type	
TLE2061AIPE4	ACTIVE	PDIP	P	8	50	Pb-Free (RoHS)	CU NIPDAU	N / A for Pkg Type	
TLE2061AMFKB	ACTIVE	LCCC	FK	20	1	TBD	POST-PLATE	N / A for Pkg Type	
TLE2061AMJGB	ACTIVE	CDIP	JG	8	1	TBD	A42	N / A for Pkg Type	
TLE2061AMP	OBSOLETE	PDIP	P	8		TBD	Call TI	Call TI	
TLE2061AMUB	ACTIVE	CFP	U	10	1	TBD	A42	N / A for Pkg Type	
TLE2061BCP	OBSOLETE	PDIP	P	8		TBD	Call TI	Call TI	
TLE2061BIP	OBSOLETE	PDIP	P	8		TBD	Call TI	Call TI	
TLE2061BMJGB	ACTIVE	CDIP	JG	8	1	TBD	A42	N / A for Pkg Type	
TLE2061CD	ACTIVE	SOIC	D	8	75	Green (RoHS & no Sb/Br)	CU NIPDAU	Level-1-260C-UNLIM	
TLE2061CDG4	ACTIVE	SOIC	D	8	75	Green (RoHS & no Sb/Br)	CU NIPDAU	Level-1-260C-UNLIM	
TLE2061CDR	ACTIVE	SOIC	D	8	2500	Green (RoHS & no Sb/Br)	CU NIPDAU	Level-1-260C-UNLIM	
TLE2061CDRG4	ACTIVE	SOIC	D	8	2500	Green (RoHS & no Sb/Br)	CU NIPDAU	Level-1-260C-UNLIM	
TLE2061CP	ACTIVE	PDIP	P	8	50	Pb-Free (RoHS)	CU NIPDAU	N / A for Pkg Type	
TLE2061CPE4	ACTIVE	PDIP	P	8	50	Pb-Free (RoHS)	CU NIPDAU	N / A for Pkg Type	
TLE2061CPSR	OBSOLETE	SO	PS	8		TBD	Call TI	Call TI	
TLE2061ID	ACTIVE	SOIC	D	8	75	Green (RoHS & no Sb/Br)	CU NIPDAU	Level-1-260C-UNLIM	
TLE2061IDG4	ACTIVE	SOIC	D	8	75	Green (RoHS & no Sb/Br)	CU NIPDAU	Level-1-260C-UNLIM	
TLE2061IDR	ACTIVE	SOIC	D	8	2500	Green (RoHS & no Sb/Br)	CU NIPDAU	Level-1-260C-UNLIM	
TLE2061IDRG4	ACTIVE	SOIC	D	8	2500	Green (RoHS & no Sb/Br)	CU NIPDAU	Level-1-260C-UNLIM	
TLE2061IP	ACTIVE	PDIP	P	8	50	Pb-Free (RoHS)	CU NIPDAU	N / A for Pkg Type	
TLE2061IPE4	ACTIVE	PDIP	P	8	50	Pb-Free (RoHS)	CU NIPDAU	N / A for Pkg Type	
TLE2061MD	ACTIVE	SOIC	D	8	75	Green (RoHS & no Sb/Br)	CU NIPDAU	Level-1-260C-UNLIM	

Orderable Device	Status ⁽¹⁾	Package Type	Package Drawing	Pins	Package Qty	Eco Plan ⁽²⁾	Lead/ Ball Finish	MSL Peak Temp ⁽³⁾	Samples (Requires Login)
TLE2061MDG4	ACTIVE	SOIC	D	8	75	Green (RoHS & no Sb/Br)	CU NIPDAU	Level-1-260C-UNLIM	
TLE2061MFKB	ACTIVE	LCCC	FK	20	1	TBD	POST-PLATE	N / A for Pkg Type	
TLE2061MJGB	ACTIVE	CDIP	JG	8	1	TBD	A42	N / A for Pkg Type	
TLE2061MP	OBSOLETE	PDIP	P	8		TBD	Call TI	Call TI	
TLE2061MUB	ACTIVE	CFP	U	10	1	TBD	A42	N / A for Pkg Type	
TLE2062ACD	ACTIVE	SOIC	D	8	75	Green (RoHS & no Sb/Br)	CU NIPDAU	Level-1-260C-UNLIM	
TLE2062ACDG4	ACTIVE	SOIC	D	8	75	Green (RoHS & no Sb/Br)	CU NIPDAU	Level-1-260C-UNLIM	
TLE2062ACDR	ACTIVE	SOIC	D	8	2500	Green (RoHS & no Sb/Br)	CU NIPDAU	Level-1-260C-UNLIM	
TLE2062ACDRG4	ACTIVE	SOIC	D	8	2500	Green (RoHS & no Sb/Br)	CU NIPDAU	Level-1-260C-UNLIM	
TLE2062ACP	OBSOLETE	PDIP	P	8		TBD	Call TI	Call TI	
TLE2062AID	ACTIVE	SOIC	D	8	75	Green (RoHS & no Sb/Br)	CU NIPDAU	Level-1-260C-UNLIM	
TLE2062AIDG4	ACTIVE	SOIC	D	8	75	Green (RoHS & no Sb/Br)	CU NIPDAU	Level-1-260C-UNLIM	
TLE2062AIDR	ACTIVE	SOIC	D	8	2500	Green (RoHS & no Sb/Br)	CU NIPDAU	Level-1-260C-UNLIM	
TLE2062AIDRG4	ACTIVE	SOIC	D	8	2500	Green (RoHS & no Sb/Br)	CU NIPDAU	Level-1-260C-UNLIM	
TLE2062AIP	OBSOLETE	PDIP	P	8		TBD	Call TI	Call TI	
TLE2062AMD	ACTIVE	SOIC	D	8	75	Green (RoHS & no Sb/Br)	CU NIPDAU	Level-1-260C-UNLIM	
TLE2062AMDG4	ACTIVE	SOIC	D	8	75	Green (RoHS & no Sb/Br)	CU NIPDAU	Level-1-260C-UNLIM	
TLE2062AMFKB	ACTIVE	LCCC	FK	20	1	TBD	POST-PLATE	N / A for Pkg Type	
TLE2062AMJG	ACTIVE	CDIP	JG	8	1	TBD	A42	N / A for Pkg Type	
TLE2062AMJGB	ACTIVE	CDIP	JG	8	1	TBD	A42	N / A for Pkg Type	
TLE2062AMP	OBSOLETE	PDIP	P	8		TBD	Call TI	Call TI	
TLE2062AMUB	ACTIVE	CFP	U	10	1	TBD	A42	N / A for Pkg Type	
TLE2062BCD	OBSOLETE	SOIC	D	8		TBD	Call TI	Call TI	

Orderable Device	Status ⁽¹⁾	Package Type	Package Drawing	Pins	Package Qty	Eco Plan ⁽²⁾	Lead/ Ball Finish	MSL Peak Temp ⁽³⁾	Samples (Requires Login)
TLE2062BCDR	OBSOLETE	SOIC	D	8		TBD	Call TI	Call TI	
TLE2062BCP	OBSOLETE	PDIP	P	8		TBD	Call TI	Call TI	
TLE2062BIP	OBSOLETE	PDIP	P	8		TBD	Call TI	Call TI	
TLE2062BMFKB	OBSOLETE	LCCC	FK	20		TBD	Call TI	Call TI	
TLE2062BMJG	ACTIVE	CDIP	JG	8	1	TBD	A42	N / A for Pkg Type	
TLE2062BMJGB	ACTIVE	CDIP	JG	8	1	TBD	A42	N / A for Pkg Type	
TLE2062CD	ACTIVE	SOIC	D	8	75	Green (RoHS & no Sb/Br)	CU NIPDAU	Level-1-260C-UNLIM	
TLE2062CDG4	ACTIVE	SOIC	D	8	75	Green (RoHS & no Sb/Br)	CU NIPDAU	Level-1-260C-UNLIM	
TLE2062CDR	ACTIVE	SOIC	D	8	2500	Green (RoHS & no Sb/Br)	CU NIPDAU	Level-1-260C-UNLIM	
TLE2062CDRG4	ACTIVE	SOIC	D	8	2500	Green (RoHS & no Sb/Br)	CU NIPDAU	Level-1-260C-UNLIM	
TLE2062CP	ACTIVE	PDIP	P	8	50	Pb-Free (RoHS)	CU NIPDAU	N / A for Pkg Type	
TLE2062CPE4	ACTIVE	PDIP	P	8	50	Pb-Free (RoHS)	CU NIPDAU	N / A for Pkg Type	
TLE2062CPSR	OBSOLETE	SO	PS	8		TBD	Call TI	Call TI	
TLE2062ID	ACTIVE	SOIC	D	8	75	Green (RoHS & no Sb/Br)	CU NIPDAU	Level-1-260C-UNLIM	
TLE2062IDG4	ACTIVE	SOIC	D	8	75	Green (RoHS & no Sb/Br)	CU NIPDAU	Level-1-260C-UNLIM	
TLE2062IDR	ACTIVE	SOIC	D	8	2500	Green (RoHS & no Sb/Br)	CU NIPDAU	Level-1-260C-UNLIM	
TLE2062IDRG4	ACTIVE	SOIC	D	8	2500	Green (RoHS & no Sb/Br)	CU NIPDAU	Level-1-260C-UNLIM	
TLE2062IP	ACTIVE	PDIP	P	8	50	Pb-Free (RoHS)	CU NIPDAU	N / A for Pkg Type	
TLE2062IPE4	ACTIVE	PDIP	P	8	50	Pb-Free (RoHS)	CU NIPDAU	N / A for Pkg Type	
TLE2062MD	ACTIVE	SOIC	D	8	75	Green (RoHS & no Sb/Br)	CU NIPDAU	Level-1-260C-UNLIM	
TLE2062MDG4	ACTIVE	SOIC	D	8	75	Green (RoHS & no Sb/Br)	CU NIPDAU	Level-1-260C-UNLIM	
TLE2062MFKB	ACTIVE	LCCC	FK	20	1	TBD	POST-PLATE	N / A for Pkg Type	
TLE2062MJG	ACTIVE	CDIP	JG	8	1	TBD	A42	N / A for Pkg Type	
TLE2062MJGB	ACTIVE	CDIP	JG	8	1	TBD	A42	N / A for Pkg Type	

Orderable Device	Status ⁽¹⁾	Package Type	Package Drawing	Pins	Package Qty	Eco Plan ⁽²⁾	Lead/ Ball Finish	MSL Peak Temp ⁽³⁾	Samples (Requires Login)
TLE2062MP	OBSOLETE	PDIP	P	8		TBD	Call TI	Call TI	
TLE2062MUB	ACTIVE	CFP	U	10	1	TBD	A42	N / A for Pkg Type	
TLE2064ACD	ACTIVE	SOIC	D	14	50	Green (RoHS & no Sb/Br)	CU NIPDAU	Level-1-260C-UNLIM	
TLE2064ACDG4	ACTIVE	SOIC	D	14	50	Green (RoHS & no Sb/Br)	CU NIPDAU	Level-1-260C-UNLIM	
TLE2064ACDR	ACTIVE	SOIC	D	14	2500	Green (RoHS & no Sb/Br)	CU NIPDAU	Level-1-260C-UNLIM	
TLE2064ACDRG4	ACTIVE	SOIC	D	14	2500	Green (RoHS & no Sb/Br)	CU NIPDAU	Level-1-260C-UNLIM	
TLE2064ACN	ACTIVE	PDIP	N	14	25	Pb-Free (RoHS)	CU NIPDAU	N / A for Pkg Type	
TLE2064ACNE4	ACTIVE	PDIP	N	14	25	Pb-Free (RoHS)	CU NIPDAU	N / A for Pkg Type	
TLE2064AID	ACTIVE	SOIC	D	14	50	Green (RoHS & no Sb/Br)	CU NIPDAU	Level-1-260C-UNLIM	
TLE2064AIDG4	ACTIVE	SOIC	D	14	50	Green (RoHS & no Sb/Br)	CU NIPDAU	Level-1-260C-UNLIM	
TLE2064AIDR	ACTIVE	SOIC	D	14	2500	Green (RoHS & no Sb/Br)	CU NIPDAU	Level-1-260C-UNLIM	
TLE2064AIDRG4	ACTIVE	SOIC	D	14	2500	Green (RoHS & no Sb/Br)	CU NIPDAU	Level-1-260C-UNLIM	
TLE2064AIN	OBSOLETE	PDIP	N	14		TBD	Call TI	Call TI	
TLE2064AMD	ACTIVE	SOIC	D	14	50	Green (RoHS & no Sb/Br)	CU NIPDAU	Level-1-260C-UNLIM	
TLE2064AMDG4	ACTIVE	SOIC	D	14	50	Green (RoHS & no Sb/Br)	CU NIPDAU	Level-1-260C-UNLIM	
TLE2064AMDR	ACTIVE	SOIC	D	14	2500	Green (RoHS & no Sb/Br)	CU NIPDAU	Level-1-260C-UNLIM	
TLE2064AMDRG4	ACTIVE	SOIC	D	14	2500	Green (RoHS & no Sb/Br)	CU NIPDAU	Level-1-260C-UNLIM	
TLE2064AMFKB	ACTIVE	LCCC	FK	20	1	TBD	POST-PLATE	N / A for Pkg Type	
TLE2064AMJ	ACTIVE	CDIP	J	14	1	TBD	A42	N / A for Pkg Type	
TLE2064AMJB	ACTIVE	CDIP	J	14	1	TBD	A42	N / A for Pkg Type	
TLE2064AMN	OBSOLETE	PDIP	N	14		TBD	Call TI	Call TI	
TLE2064AMWB	ACTIVE	CFP	W	14	1	TBD	A42	N / A for Pkg Type	

Orderable Device	Status ⁽¹⁾	Package Type	Package Drawing	Pins	Package Qty	Eco Plan ⁽²⁾	Lead/ Ball Finish	MSL Peak Temp ⁽³⁾	Samples (Requires Login)
TLE2064BCN	OBSOLETE	PDIP	N	14		TBD	Call TI	Call TI	
TLE2064BIN	OBSOLETE	PDIP	N	14		TBD	Call TI	Call TI	
TLE2064BMFKB	ACTIVE	LCCC	FK	20	1	TBD	POST-PLATE	N / A for Pkg Type	
TLE2064BMJ	ACTIVE	CDIP	J	14	1	TBD	A42	N / A for Pkg Type	
TLE2064BMJB	ACTIVE	CDIP	J	14	1	TBD	A42	N / A for Pkg Type	
TLE2064BMN	OBSOLETE	PDIP	N	14		TBD	Call TI	Call TI	
TLE2064CD	ACTIVE	SOIC	D	14	50	Green (RoHS & no Sb/Br)	CU NIPDAU	Level-1-260C-UNLIM	
TLE2064CDG4	ACTIVE	SOIC	D	14	50	Green (RoHS & no Sb/Br)	CU NIPDAU	Level-1-260C-UNLIM	
TLE2064CDR	ACTIVE	SOIC	D	14	2500	Green (RoHS & no Sb/Br)	CU NIPDAU	Level-1-260C-UNLIM	
TLE2064CDRG4	ACTIVE	SOIC	D	14	2500	Green (RoHS & no Sb/Br)	CU NIPDAU	Level-1-260C-UNLIM	
TLE2064CN	ACTIVE	PDIP	N	14	25	Pb-Free (RoHS)	CU NIPDAU	N / A for Pkg Type	
TLE2064CNE4	ACTIVE	PDIP	N	14	25	Pb-Free (RoHS)	CU NIPDAU	N / A for Pkg Type	
TLE2064CNSR	OBSOLETE	SO	NS	14		TBD	Call TI	Call TI	
TLE2064ID	ACTIVE	SOIC	D	14	50	Green (RoHS & no Sb/Br)	CU NIPDAU	Level-1-260C-UNLIM	
TLE2064IDG4	ACTIVE	SOIC	D	14	50	Green (RoHS & no Sb/Br)	CU NIPDAU	Level-1-260C-UNLIM	
TLE2064IDR	ACTIVE	SOIC	D	14	2500	Green (RoHS & no Sb/Br)	CU NIPDAU	Level-1-260C-UNLIM	
TLE2064IDRG4	ACTIVE	SOIC	D	14	2500	Green (RoHS & no Sb/Br)	CU NIPDAU	Level-1-260C-UNLIM	
TLE2064IN	ACTIVE	PDIP	N	14	25	Pb-Free (RoHS)	CU NIPDAU	N / A for Pkg Type	
TLE2064INE4	ACTIVE	PDIP	N	14	25	Pb-Free (RoHS)	CU NIPDAU	N / A for Pkg Type	
TLE2064MD	ACTIVE	SOIC	D	14	50	Green (RoHS & no Sb/Br)	CU NIPDAU	Level-1-260C-UNLIM	
TLE2064MDG4	ACTIVE	SOIC	D	14	50	Green (RoHS & no Sb/Br)	CU NIPDAU	Level-1-260C-UNLIM	
TLE2064MDR	ACTIVE	SOIC	D	14	1	Green (RoHS & no Sb/Br)	CU NIPDAU	Level-1-260C-UNLIM	

Orderable Device	Status ⁽¹⁾	Package Type	Package Drawing	Pins	Package Qty	Eco Plan ⁽²⁾	Lead/ Ball Finish	MSL Peak Temp ⁽³⁾	Samples (Requires Login)
TLE2064MDRG4	ACTIVE	SOIC	D	14	2500	Green (RoHS & no Sb/Br)	CU NIPDAU	Level-1-260C-UNLIM	
TLE2064MFKB	ACTIVE	LCCC	FK	20	1	TBD	POST-PLATE	N / A for Pkg Type	
TLE2064MJ	ACTIVE	CDIP	J	14	1	TBD	A42	N / A for Pkg Type	
TLE2064MJB	ACTIVE	CDIP	J	14	1	TBD	A42	N / A for Pkg Type	
TLE2064MN	OBSOLETE	PDIP	N	14		TBD	Call TI	Call TI	
TLE2064MWB	ACTIVE	CFP	W	14	1	TBD	A42	N / A for Pkg Type	

⁽¹⁾ The marketing status values are defined as follows:

ACTIVE: Product device recommended for new designs.

LIFEBUY: TI has announced that the device will be discontinued, and a lifetime-buy period is in effect.

NRND: Not recommended for new designs. Device is in production to support existing customers, but TI does not recommend using this part in a new design.

PREVIEW: Device has been announced but is not in production. Samples may or may not be available.

OBSOLETE: TI has discontinued the production of the device.

⁽²⁾ Eco Plan - The planned eco-friendly classification: Pb-Free (RoHS), Pb-Free (RoHS Exempt), or Green (RoHS & no Sb/Br) - please check <http://www.ti.com/productcontent> for the latest availability information and additional product content details.

TBD: The Pb-Free/Green conversion plan has not been defined.

Pb-Free (RoHS): TI's terms "Lead-Free" or "Pb-Free" mean semiconductor products that are compatible with the current RoHS requirements for all 6 substances, including the requirement that lead not exceed 0.1% by weight in homogeneous materials. Where designed to be soldered at high temperatures, TI Pb-Free products are suitable for use in specified lead-free processes.

Pb-Free (RoHS Exempt): This component has a RoHS exemption for either 1) lead-based flip-chip solder bumps used between the die and package, or 2) lead-based die adhesive used between the die and leadframe. The component is otherwise considered Pb-Free (RoHS compatible) as defined above.

Green (RoHS & no Sb/Br): TI defines "Green" to mean Pb-Free (RoHS compatible), and free of Bromine (Br) and Antimony (Sb) based flame retardants (Br or Sb do not exceed 0.1% by weight in homogeneous material)

⁽³⁾ MSL, Peak Temp. -- The Moisture Sensitivity Level rating according to the JEDEC industry standard classifications, and peak solder temperature.

Important Information and Disclaimer: The information provided on this page represents TI's knowledge and belief as of the date that it is provided. TI bases its knowledge and belief on information provided by third parties, and makes no representation or warranty as to the accuracy of such information. Efforts are underway to better integrate information from third parties. TI has taken and continues to take reasonable steps to provide representative and accurate information but may not have conducted destructive testing or chemical analysis on incoming materials and chemicals. TI and TI suppliers consider certain information to be proprietary, and thus CAS numbers and other limited information may not be available for release.

In no event shall TI's liability arising out of such information exceed the total purchase price of the TI part(s) at issue in this document sold by TI to Customer on an annual basis.

OTHER QUALIFIED VERSIONS OF TLE2061, TLE2061A, TLE2061AM, TLE2061B, TLE2061BM, TLE2061M, TLE2062, TLE2062A, TLE2062AM, TLE2062B, TLE2062BM, TLE2062M, TLE2064, TLE2064A, TLE2064AM, TLE2064B, TLE2064BM, TLE2064M :

● Catalog: [TLE2061A](#), [TLE2061B](#), [TLE2061](#), [TLE2062A](#), [TLE2062B](#), [TLE2062](#), [TLE2064A](#), [TLE2064B](#), [TLE2064](#)

- Military: [TLE2061M](#), [TLE2061AM](#), [TLE2061BM](#), [TLE2062M](#), [TLE2062AM](#), [TLE2062BM](#), [TLE2064M](#), [TLE2064AM](#), [TLE2064BM](#)

NOTE: Qualified Version Definitions:

- Catalog - TI's standard catalog product
- Military - QML certified for Military and Defense Applications

TAPE AND REEL INFORMATION
REEL DIMENSIONS

TAPE DIMENSIONS

A0	Dimension designed to accommodate the component width
B0	Dimension designed to accommodate the component length
K0	Dimension designed to accommodate the component thickness
W	Overall width of the carrier tape
P1	Pitch between successive cavity centers

TAPE AND REEL INFORMATION

*All dimensions are nominal

Device	Package Type	Package Drawing	Pins	SPQ	Reel Diameter (mm)	Reel Width W1 (mm)	A0 (mm)	B0 (mm)	K0 (mm)	P1 (mm)	W (mm)	Pin1 Quadrant
TLE2061CDR	SOIC	D	8	2500	330.0	12.4	6.4	5.2	2.1	8.0	12.0	Q1
TLE2061IDR	SOIC	D	8	2500	330.0	12.4	6.4	5.2	2.1	8.0	12.0	Q1
TLE2062ACDR	SOIC	D	8	2500	330.0	12.4	6.4	5.2	2.1	8.0	12.0	Q1
TLE2062AIDR	SOIC	D	8	2500	330.0	12.4	6.4	5.2	2.1	8.0	12.0	Q1
TLE2062CDR	SOIC	D	8	2500	330.0	12.4	6.4	5.2	2.1	8.0	12.0	Q1
TLE2062IDR	SOIC	D	8	2500	330.0	12.4	6.4	5.2	2.1	8.0	12.0	Q1
TLE2064ACDR	SOIC	D	14	2500	330.0	16.4	6.5	9.0	2.1	8.0	16.0	Q1
TLE2064AIDR	SOIC	D	14	2500	330.0	16.4	6.5	9.0	2.1	8.0	16.0	Q1
TLE2064AMDR	SOIC	D	14	2500	330.0	16.4	6.5	9.0	2.1	8.0	16.0	Q1
TLE2064CDR	SOIC	D	14	2500	330.0	16.4	6.5	9.0	2.1	8.0	16.0	Q1
TLE2064IDR	SOIC	D	14	2500	330.0	16.4	6.5	9.0	2.1	8.0	16.0	Q1
TLE2064MDR	SOIC	D	14	1	330.0	16.4	6.5	9.0	2.1	8.0	16.0	Q1

TAPE AND REEL BOX DIMENSIONS

*All dimensions are nominal

Device	Package Type	Package Drawing	Pins	SPQ	Length (mm)	Width (mm)	Height (mm)
TLE2061CDR	SOIC	D	8	2500	340.5	338.1	20.6
TLE2061IDR	SOIC	D	8	2500	340.5	338.1	20.6
TLE2062ACDR	SOIC	D	8	2500	340.5	338.1	20.6
TLE2062AIDR	SOIC	D	8	2500	340.5	338.1	20.6
TLE2062CDR	SOIC	D	8	2500	340.5	338.1	20.6
TLE2062IDR	SOIC	D	8	2500	340.5	338.1	20.6
TLE2064ACDR	SOIC	D	14	2500	367.0	367.0	38.0
TLE2064AIDR	SOIC	D	14	2500	367.0	367.0	38.0
TLE2064AMDR	SOIC	D	14	2500	367.0	367.0	38.0
TLE2064CDR	SOIC	D	14	2500	367.0	367.0	38.0
TLE2064IDR	SOIC	D	14	2500	367.0	367.0	38.0
TLE2064MDR	SOIC	D	14	1	367.0	367.0	38.0

JG (R-GDIP-T8)

CERAMIC DUAL-IN-LINE



- NOTES: A. All linear dimensions are in inches (millimeters).
 B. This drawing is subject to change without notice.
 C. This package can be hermetically sealed with a ceramic lid using glass frit.
 D. Index point is provided on cap for terminal identification.
 E. Falls within MIL STD 1835 GDIP1-T8

J (R-GDIP-T**)

14 LEADS SHOWN

CERAMIC DUAL IN-LINE PACKAGE



DIM \ PINS **	14	16	18	20
A	0.300 (7,62) BSC	0.300 (7,62) BSC	0.300 (7,62) BSC	0.300 (7,62) BSC
B MAX	0.785 (19,94)	.840 (21,34)	0.960 (24,38)	1.060 (26,92)
B MIN	—	—	—	—
C MAX	0.300 (7,62)	0.300 (7,62)	0.310 (7,87)	0.300 (7,62)
C MIN	0.245 (6,22)	0.245 (6,22)	0.220 (5,59)	0.245 (6,22)



4040083/F 03/03

- NOTES:
- All linear dimensions are in inches (millimeters).
 - This drawing is subject to change without notice.
 - This package is hermetically sealed with a ceramic lid using glass frit.
 - Index point is provided on cap for terminal identification only on press ceramic glass frit seal only.
 - Falls within MIL STD 1835 GDIP1-T14, GDIP1-T16, GDIP1-T18 and GDIP1-T20.

U (S-GDFP-F10)

CERAMIC DUAL FLATPACK

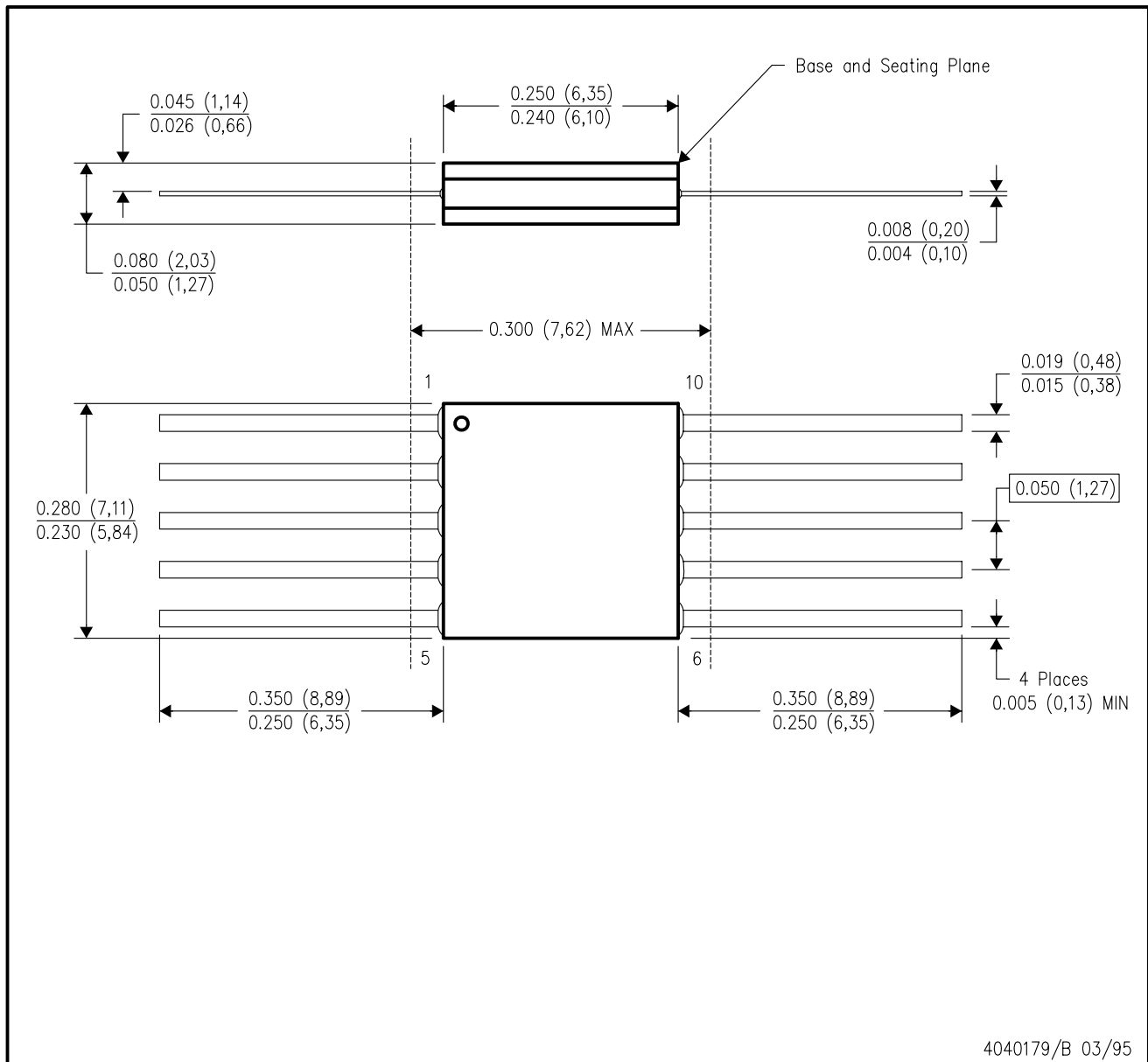

4040179/B 03/95

- NOTES:
- A. All linear dimensions are in inches (millimeters).
 - B. This drawing is subject to change without notice.
 - C. This package can be hermetically sealed with a ceramic lid using glass frit.
 - D. Index point is provided on cap for terminal identification only.
 - E. Falls within MIL STD 1835 GDFP1-F10 and JEDEC MO-092AA

W (R-GDFP-F14)

CERAMIC DUAL FLATPACK



- NOTES:
- A. All linear dimensions are in inches (millimeters).
 - B. This drawing is subject to change without notice.
 - C. This package can be hermetically sealed with a ceramic lid using glass frit.
 - D. Index point is provided on cap for terminal identification only.
 - E. Falls within MIL STD 1835 GDFP1-F14 and JEDEC MO-092AB

FK (S-CQCC-N**)

LEADLESS CERAMIC CHIP CARRIER

28 TERMINAL SHOWN



NO. OF TERMINALS **	A		B	
	MIN	MAX	MIN	MAX
20	0.342 (8,69)	0.358 (9,09)	0.307 (7,80)	0.358 (9,09)
28	0.442 (11,23)	0.458 (11,63)	0.406 (10,31)	0.458 (11,63)
44	0.640 (16,26)	0.660 (16,76)	0.495 (12,58)	0.560 (14,22)
52	0.740 (18,78)	0.761 (19,32)	0.495 (12,58)	0.560 (14,22)
68	0.938 (23,83)	0.962 (24,43)	0.850 (21,6)	0.858 (21,8)
84	1.141 (28,99)	1.165 (29,59)	1.047 (26,6)	1.063 (27,0)



4040140/D 01/11

- NOTES:
- All linear dimensions are in inches (millimeters).
 - This drawing is subject to change without notice.
 - This package can be hermetically sealed with a metal lid.
 - Falls within JEDEC MS-004

P (R-PDIP-T8)

PLASTIC DUAL-IN-LINE PACKAGE



- NOTES:
- A. All linear dimensions are in inches (millimeters).
 - B. This drawing is subject to change without notice.
 - C. Falls within JEDEC MS-001 variation BA.

N (R-PDIP-T**)

PLASTIC DUAL-IN-LINE PACKAGE

16 PINS SHOWN



- NOTES:
- A. All linear dimensions are in inches (millimeters).
 - B. This drawing is subject to change without notice.
 - C Falls within JEDEC MS-001, except 18 and 20 pin minimum body length (Dim A).
 - D The 20 pin end lead shoulder width is a vendor option, either half or full width.

4040049/E 12/2002

D (R-PDSO-G14)

PLASTIC SMALL OUTLINE



- NOTES:
- A. All linear dimensions are in inches (millimeters).
 - B. This drawing is subject to change without notice.
 -  Body length does not include mold flash, protrusions, or gate burrs. Mold flash, protrusions, or gate burrs shall not exceed 0.006 (0,15) each side.
 -  Body width does not include interlead flash. Interlead flash shall not exceed 0.017 (0,43) each side.
 - E. Reference JEDEC MS-012 variation AB.

D (R-PDSO-G8)

PLASTIC SMALL OUTLINE



4040047-3/M 06/11

D (R-PDSO-G8)

PLASTIC SMALL OUTLINE



- NOTES:
- A. All linear dimensions are in millimeters.
 - B. This drawing is subject to change without notice.
 - C. Publication IPC-7351 is recommended for alternate designs.
 - D. Laser cutting apertures with trapezoidal walls and also rounding corners will offer better paste release. Customers should contact their board assembly site for stencil design recommendations. Refer to IPC-7525 for other stencil recommendations.
 - E. Customers should contact their board fabrication site for solder mask tolerances between and around signal pads.

MECHANICAL DATA

PS (R-PDSO-G8)

PLASTIC SMALL-OUTLINE PACKAGE



- NOTES:
- A. All linear dimensions are in millimeters.
 - B. This drawing is subject to change without notice.
 - C. Body dimensions do not include mold flash or protrusion, not to exceed 0,15.

MECHANICAL DATA

NS (R-PDSO-G**)

PLASTIC SMALL-OUTLINE PACKAGE

14-PINS SHOWN



- NOTES:
- A. All linear dimensions are in millimeters.
 - B. This drawing is subject to change without notice.
 - C. Body dimensions do not include mold flash or protrusion, not to exceed 0,15.

IMPORTANT NOTICE

Texas Instruments Incorporated and its subsidiaries (TI) reserve the right to make corrections, enhancements, improvements and other changes to its semiconductor products and services per JESD46, latest issue, and to discontinue any product or service per JESD48, latest issue. Buyers should obtain the latest relevant information before placing orders and should verify that such information is current and complete. All semiconductor products (also referred to herein as "components") are sold subject to TI's terms and conditions of sale supplied at the time of order acknowledgment.

TI warrants performance of its components to the specifications applicable at the time of sale, in accordance with the warranty in TI's terms and conditions of sale of semiconductor products. Testing and other quality control techniques are used to the extent TI deems necessary to support this warranty. Except where mandated by applicable law, testing of all parameters of each component is not necessarily performed.

TI assumes no liability for applications assistance or the design of Buyers' products. Buyers are responsible for their products and applications using TI components. To minimize the risks associated with Buyers' products and applications, Buyers should provide adequate design and operating safeguards.

TI does not warrant or represent that any license, either express or implied, is granted under any patent right, copyright, mask work right, or other intellectual property right relating to any combination, machine, or process in which TI components or services are used. Information published by TI regarding third-party products or services does not constitute a license to use such products or services or a warranty or endorsement thereof. Use of such information may require a license from a third party under the patents or other intellectual property of the third party, or a license from TI under the patents or other intellectual property of TI.

Reproduction of significant portions of TI information in TI data books or data sheets is permissible only if reproduction is without alteration and is accompanied by all associated warranties, conditions, limitations, and notices. TI is not responsible or liable for such altered documentation. Information of third parties may be subject to additional restrictions.

Resale of TI components or services with statements different from or beyond the parameters stated by TI for that component or service voids all express and any implied warranties for the associated TI component or service and is an unfair and deceptive business practice. TI is not responsible or liable for any such statements.

Buyer acknowledges and agrees that it is solely responsible for compliance with all legal, regulatory and safety-related requirements concerning its products, and any use of TI components in its applications, notwithstanding any applications-related information or support that may be provided by TI. Buyer represents and agrees that it has all the necessary expertise to create and implement safeguards which anticipate dangerous consequences of failures, monitor failures and their consequences, lessen the likelihood of failures that might cause harm and take appropriate remedial actions. Buyer will fully indemnify TI and its representatives against any damages arising out of the use of any TI components in safety-critical applications.

In some cases, TI components may be promoted specifically to facilitate safety-related applications. With such components, TI's goal is to help enable customers to design and create their own end-product solutions that meet applicable functional safety standards and requirements. Nonetheless, such components are subject to these terms.

No TI components are authorized for use in FDA Class III (or similar life-critical medical equipment) unless authorized officers of the parties have executed a special agreement specifically governing such use.

Only those TI components which TI has specifically designated as military grade or "enhanced plastic" are designed and intended for use in military/aerospace applications or environments. Buyer acknowledges and agrees that any military or aerospace use of TI components which have **not** been so designated is solely at the Buyer's risk, and that Buyer is solely responsible for compliance with all legal and regulatory requirements in connection with such use.

TI has specifically designated certain components which meet ISO/TS16949 requirements, mainly for automotive use. Components which have not been so designated are neither designed nor intended for automotive use; and TI will not be responsible for any failure of such components to meet such requirements.

Products

Audio	www.ti.com/audio
Amplifiers	amplifier.ti.com
Data Converters	dataconverter.ti.com
DLP® Products	www.dlp.com
DSP	dsp.ti.com
Clocks and Timers	www.ti.com/clocks
Interface	interface.ti.com
Logic	logic.ti.com
Power Mgmt	power.ti.com
Microcontrollers	microcontroller.ti.com
RFID	www.ti-rfid.com
OMAP Applications Processors	www.ti.com/omap
Wireless Connectivity	www.ti.com/wirelessconnectivity

Applications

Automotive and Transportation	www.ti.com/automotive
Communications and Telecom	www.ti.com/communications
Computers and Peripherals	www.ti.com/computers
Consumer Electronics	www.ti.com/consumer-apps
Energy and Lighting	www.ti.com/energy
Industrial	www.ti.com/industrial
Medical	www.ti.com/medical
Security	www.ti.com/security
Space, Avionics and Defense	www.ti.com/space-avionics-defense
Video and Imaging	www.ti.com/video

TI E2E Community

e2e.ti.com