

## 8-Bit Serial-In/Parallel-Out Shift Register

### Features

- Buffered Inputs
- Typical Propagation Delay
  - 6ns at  $V_{CC} = 5V$ ,  $T_A = 25^{\circ}C$ ,  $C_L = 50pF$
- Exceeds 2kV ESD Protection MIL-STD-883, Method 3015
- SCR-Latchup-Resistant CMOS Process and Circuit Design
- Speed of Bipolar FAST™/AS/S with Significantly Reduced Power Consumption
- Balanced Propagation Delays
- AC Types Feature 1.5V to 5.5V Operation and Balanced Noise Immunity at 30% of the Supply
- $\pm 24mA$  Output Drive Current
  - Fanout to 15 FAST™ ICs
  - Drives 50 $\Omega$  Transmission Lines

### Description

The 'AC164 and 'ACT164 are 8-bit serial-in/parallel-out shift registers with asynchronous reset that utilize Advanced CMOS Logic technology. Data is shifted on the positive edge of the clock (CP). A LOW on the Master Reset ( $\overline{MR}$ ) pin resets the shift register and all outputs go to the LOW state regardless of the input conditions. Two Serial Data inputs (DS1 and DS2) are provided; either one can be used as a Data Enable control.

### Ordering Information

PART NUMBER	TEMP. RANGE ( $^{\circ}C$ )	PACKAGE
CD54AC164F3A	-55 to 125	14 Ld CERDIP
CD74AC164E	-55 to 125	14 Ld PDIP
CD74AC164M	-55 to 125	14 Ld SOIC
CD54ACT164F3A	-55 to 125	14 Ld CERDIP
CD74ACT164E	-55 to 125	14 Ld PDIP
CD74ACT164M	-55 to 125	14 Ld SOIC

#### NOTES:

1. When ordering, use the entire part number. Add the suffix 96 to obtain the variant in the tape and reel.
2. Wafer and die for this part number is available which meets all electrical specifications. Please contact your local TI sales office or customer service for ordering information.

### Pinout

CD54AC164, CD54ACT164  
(CERDIP)  
CD74AC164, CD74ACT164  
(PDIP, SOIC)  
TOP VIEW

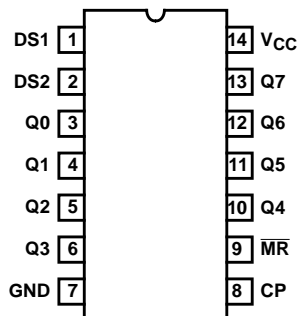

**CD54/74AC164, CD54/74ACT164**

**Functional Diagram**

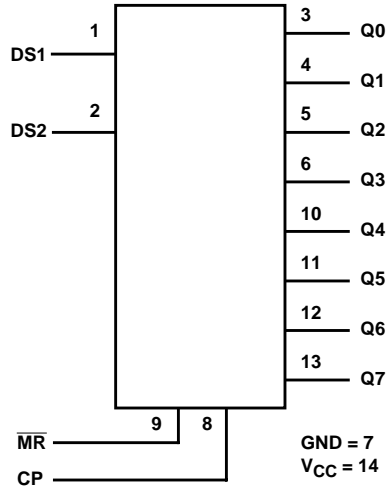

**MODE SELECT - TRUTH TABLE**

OPERATING MODE	INPUTS				OUTPUTS	
	MR	CP	DS1	DS2	Q0	Q1 - Q7
<b>RESET (CLEAR)</b>	L	X	X	X	L	L - L
SHIFT	H	↑	l	l	L	q0 - q6
	H	↑	l	h	L	q0 - q6
	H	↑	h	l	L	q0 - q6
	H	↑	h	h	H	q0 - q6

H = HIGH voltage level steady state.

L = LOW voltage level steady state.

h = HIGH voltage level one setup time prior to the LOW-to\_HIGH clock transition.

l = LOW voltage level one setup time prior to the LOW-to-HIGH clock transition.

X = Don't care.

q = Lowercase letters indicate the state of the referenced output prior to the LOW-to-HIGH clock transition.

↑ = LOW-to-HIGH clock transition.

## CD54/74AC164, CD54/74ACT164

### Absolute Maximum Ratings

DC Supply Voltage, $V_{CC}$ .....	-0.5V to 6V
DC Input Diode Current, $I_{IK}$	
For $V_I < -0.5V$ or $V_I > V_{CC} + 0.5V$ .....	$\pm 20mA$
DC Output Diode Current, $I_{OK}$	
For $V_O < -0.5V$ or $V_O > V_{CC} + 0.5V$ .....	$\pm 50mA$
DC Output Source or Sink Current per Output Pin, $I_O$	
For $V_O > -0.5V$ or $V_O < V_{CC} + 0.5V$ .....	$\pm 50mA$
DC $V_{CC}$ or Ground Current, $I_{CC}$ or $I_{GND}$ (Note 3) .....	$\pm 100mA$

### Thermal Information

Thermal Resistance (Typical, Note 5)	$\theta_{JA}$ ( $^{\circ}C/W$ )
PDIP Package .....	90
SOIC Package .....	175
Maximum Junction Temperature (Plastic Package) .....	$150^{\circ}C$
Maximum Storage Temperature Range .....	$-65^{\circ}C$ to $150^{\circ}C$
Maximum Lead Temperature (Soldering 10s) .....	$300^{\circ}C$ (SOIC - Lead Tips Only)

### Operating Conditions

Temperature Range, $T_A$ .....	$-55^{\circ}C$ to $125^{\circ}C$
Supply Voltage Range, $V_{CC}$ (Note 4)	
AC Types .....	1.5V to 5.5V
ACT Types .....	4.5V to 5.5V
DC Input or Output Voltage, $V_I$ , $V_O$ .....	0V to $V_{CC}$
Input Rise and Fall Slew Rate, dt/dv	
AC Types, 1.5V to 3V .....	50ns (Max)
AC Types, 3.6V to 5.5V .....	20ns (Max)
ACT Types, 4.5V to 5.5V .....	10ns (Max)

*CAUTION: Stresses above those listed in "Absolute Maximum Ratings" may cause permanent damage to the device. This is a stress only rating and operation of the device at these or any other conditions above those indicated in the operational sections of this specification is not implied.*

#### NOTES:

3. For up to 4 outputs per device, add  $\pm 25mA$  for each additional output.
4. Unless otherwise specified, all voltages are referenced to ground.
5.  $\theta_{JA}$  is measured with the component mounted on an evaluation PC board in free air.

### DC Electrical Specifications

PARAMETER	SYMBOL	TEST CONDITIONS		$V_{CC}$ (V)	25 $^{\circ}C$		-40 $^{\circ}C$ TO 85 $^{\circ}C$		-55 $^{\circ}C$ TO 125 $^{\circ}C$		UNITS	
		$V_I$ (V)	$I_O$ (mA)		MIN	MAX	MIN	MAX	MIN	MAX		
<b>AC TYPES</b>												
High Level Input Voltage	$V_{IH}$	-	-	1.5	1.2	-	1.2	-	1.2	-	V	
				3	2.1	-	2.1	-	2.1	-	V	
				5.5	3.85	-	3.85	-	3.85	-	V	
Low Level Input Voltage	$V_{IL}$	-	-	1.5	-	0.3	-	0.3	-	0.3	V	
				3	-	0.9	-	0.9	-	0.9	V	
				5.5	-	1.65	-	1.65	-	1.65	V	
High Level Output Voltage	$V_{OH}$	$V_{IH}$ or $V_{IL}$	-0.05	-0.05	1.5	1.4	-	1.4	-	1.4	-	V
			-0.05	-0.05	3	2.9	-	2.9	-	2.9	-	V
			-0.05	-0.05	4.5	4.4	-	4.4	-	4.4	-	V
			-4	-4	3	2.58	-	2.48	-	2.4	-	V
			-24	-24	4.5	3.94	-	3.8	-	3.7	-	V
			-75 (Note 6, 7)	-75	5.5	-	-	3.85	-	-	-	V
			-50 (Note 6, 7)	-50	5.5	-	-	-	-	3.85	-	V

**CD54/74AC164, CD54/74ACT164**

**DC Electrical Specifications (Continued)**

PARAMETER	SYMBOL	TEST CONDITIONS		V <sub>CC</sub> (V)	25°C		-40°C TO 85°C		-55°C TO 125°C		UNITS
		V <sub>I</sub> (V)	I <sub>O</sub> (mA)		MIN	MAX	MIN	MAX	MIN	MAX	
Low Level Output Voltage	V <sub>OL</sub>	V <sub>IH</sub> or V <sub>IL</sub>	0.05	1.5	-	0.1	-	0.1	-	0.1	V
			0.05	3	-	0.1	-	0.1	-	0.1	V
			0.05	4.5	-	0.1	-	0.1	-	0.1	V
			12	3	-	0.36	-	0.44	-	0.5	V
			24	4.5	-	0.36	-	0.44	-	0.5	V
			75 (Note 6, 7)	5.5	-	-	-	1.65	-	-	V
			50 (Note 6, 7)	5.5	-	-	-	-	-	1.65	V
Input Leakage Current	I <sub>I</sub>	V <sub>CC</sub> or GND	-	5.5	-	±0.1	-	±1	-	±1	µA
Quiescent Supply Current MSI	I <sub>CC</sub>	V <sub>CC</sub> or GND	0	5.5	-	8	-	80	-	160	µA
<b>ACT TYPES</b>											
High Level Input Voltage	V <sub>IH</sub>	-	-	4.5 to 5.5	2	-	2	-	2	-	V
Low Level Input Voltage	V <sub>IL</sub>	-	-	4.5 to 5.5	-	0.8	-	0.8	-	0.8	V
High Level Output Voltage	V <sub>OH</sub>	V <sub>IH</sub> or V <sub>IL</sub>	-0.05	4.5	4.4	-	4.4	-	4.4	-	V
			-24	4.5	3.94	-	3.8	-	3.7	-	V
			-75 (Note 6, 7)	5.5	-	-	3.85	-	-	-	V
			-50 (Note 6, 7)	5.5	-	-	-	-	3.85	-	V
Low Level Output Voltage	V <sub>OL</sub>	V <sub>IH</sub> or V <sub>IL</sub>	0.05	4.5	-	0.1	-	0.1	-	0.1	V
			24	4.5	-	0.36	-	0.44	-	0.5	V
			75 (Note 6, 7)	5.5	-	-	-	1.65	-	-	V
			50 (Note 6, 7)	5.5	-	-	-	-	-	1.65	V
Input Leakage Current	I <sub>I</sub>	V <sub>CC</sub> or GND	-	5.5	-	±0.1	-	±1	-	±1	µA
Quiescent Supply Current MSI	I <sub>CC</sub>	V <sub>CC</sub> or GND	0	5.5	-	8	-	80	-	160	µA
Additional Supply Current per Input Pin TTL Inputs High 1 Unit Load	ΔI <sub>CC</sub>	V <sub>CC</sub> -2.1	-	4.5 to 5.5	-	2.4	-	2.8	-	3	mA

**NOTES:**

- Test one output at a time for a 1-second maximum duration. Measurement is made by forcing current and measuring voltage to minimize power dissipation.
- Test verifies a minimum 50Ω transmission-line-drive capability at 85°C, 75Ω at 125°C.

**ACT Input Load Table**

INPUT	UNIT LOAD
DS1, DS2	0.5
MR	0.74
CP	0.71

NOTE: Unit load is ΔI<sub>CC</sub> limit specified in DC Electrical Specifications Table, e.g., 2.4mA max at 25°C.

## CD54/74AC164, CD54/74ACT164

### Prerequisite For Switching Function

PARAMETER	SYMBOL	V <sub>CC</sub> (V)	-40°C TO 85°C		-55°C TO 125°C		UNITS
			MIN	MAX	MIN	MAX	
<b>AC TYPES</b>							
Max. Clock Frequency	f <sub>MAX</sub>	1.5	7	-	6	-	MHz
		3.3 (Note 9)	62	-	54	-	MHz
		5 (Note 10)	86	-	75	-	MHz
MR Pulse Width	t <sub>W</sub>	1.5	49	-	56	-	ns
		3.3	5.5	-	6.3	-	ns
		5	3.9	-	4.5	-	ns
CP Pulse Width	t <sub>W</sub>	1.5	73	-	84	-	ns
		3.3	8.2	-	9.4	-	ns
		5	5.9	-	6.7	-	ns
Set-up Time	t <sub>SU</sub>	1.5	27	-	31	-	ns
		3.3	3.1	-	3.5	-	ns
		5	2.2	-	2.5	-	ns
Hold Time	t <sub>H</sub>	1.5	27	-	31	-	ns
		3.3	3.1	-	3.5	-	ns
		5	2.2	-	2.5	-	ns
MR to CP Removal Time	t <sub>REM</sub>	1.5	1	-	1	-	ns
		3.3	1	-	1	-	ns
		5	1	-	1	-	ns
<b>ACT TYPES</b>							
Max. Clock Frequency	f <sub>MAX</sub>	5 (Note 10)	80	-	70	-	MHz
MR Pulse Width	t <sub>W</sub>	5	3.9	-	4.5	-	ns
CP Pulse Width	t <sub>W</sub>	5	6.2	-	7.1	-	ns
Set-up Time	t <sub>SU</sub>	5	2.2	-	2.5	-	ns
Hold Time	t <sub>H</sub>	5	2.6	-	3	-	ns
MR to CP Removal Time	t <sub>REM</sub>	5	0	-	0	-	ns

### Switching Specifications Input t<sub>r</sub>, t<sub>f</sub> = 3ns, C<sub>L</sub> = 50pF (Worst Case)

PARAMETER	SYMBOL	V <sub>CC</sub> (V)	-40°C TO 85°C			-55°C TO 125°C			UNITS
			MIN	TYP	MAX	MIN	TYP	MAX	
<b>AC TYPES</b>									
Propagation Delay, CP to Qn	t <sub>PLH</sub> , t <sub>PHL</sub>	1.5	-	-	143	-	-	157	ns
		3.3 (Note 9)	4.5	-	15.9	4.4	-	17.5	ns
		5 (Note 10)	3.2	-	11.4	3.1	-	12.5	ns

## CD54/74AC164, CD54/74ACT164

### Switching Specifications Input $t_r$ , $t_f = 3\text{ns}$ , $C_L = 50\text{pF}$ (Worst Case) (Continued)

PARAMETER	SYMBOL	$V_{CC}$ (V)	-40°C TO 85°C			-55°C TO 125°C			UNITS
			MIN	TYP	MAX	MIN	TYP	MAX	
Propagation Delay, $\overline{\text{MR}}$ to $Q_n$	$t_{PLH}$ , $t_{PHL}$	1.5	-	-	158	-	-	174	ns
		3.3	5	-	17.7	4.9	-	19.5	ns
		5	3.6	-	12.6	3.5	-	13.9	ns
Input Capacitance	$C_I$	-	-	-	10	-	-	10	pF
Power Dissipation Capacitance	$C_{PD}$ (Note 11)	-	-	150	-	-	150	-	pF
<b>ACT TYPES</b>									
Propagation Delay, CP to $Q_n$	$t_{PLH}$ , $t_{PHL}$	5 (Note 10)	3.8	-	13.5	3.7	-	14.9	ns
Propagation Delay, $\overline{\text{MR}}$ to $Q_n$	$t_{PLH}$ , $t_{PHL}$	5	4.1	-	14.4	4	-	15.8	ns
Input Capacitance	$C_I$	-	-	-	10	-	-	10	pF
Power Dissipation Capacitance	$C_{PD}$ (Note 11)	-	-	150	-	-	150	-	pF

**NOTES:**

8. Limits tested at 100%.
9. 3.3V Min at 3.6V, Max at 3V.
10. 5V Min at 5.5V, Max at 4.5V.
11.  $C_{PD}$  is used to determine the dynamic power consumption per device.  
 $P_D = C_{PD}V_{CC}^2 f_i \Sigma (C_L V_{CC}^2 f_o) + V_{CC} \Delta I_{CC}$ , where  $f_i$  = input frequency,  $f_o$  = output frequency,  $C_L$  = output load capacitance,  $V_{CC}$  = supply voltage.

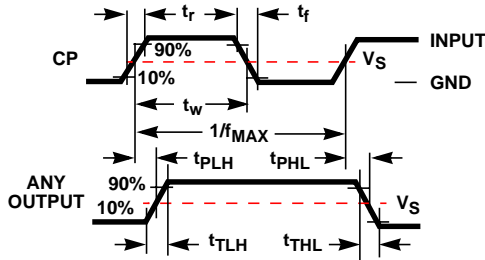

FIGURE 1.

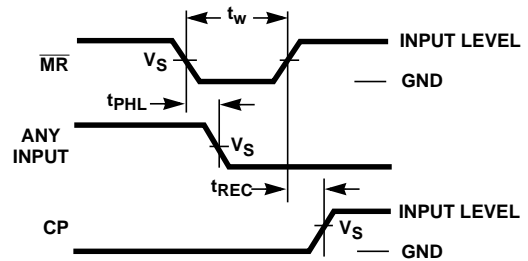

FIGURE 2.

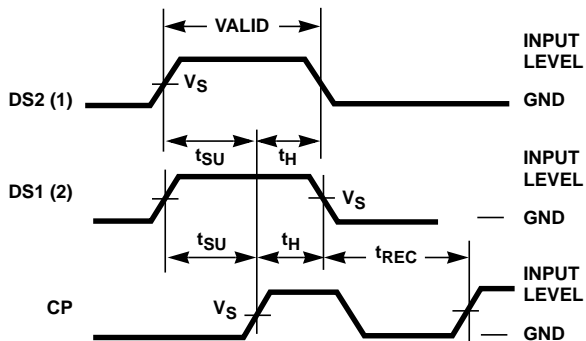

FIGURE 3.

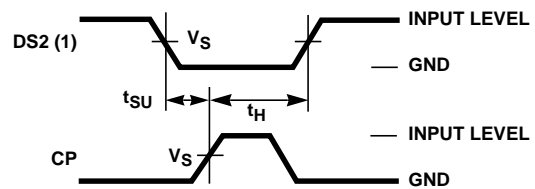
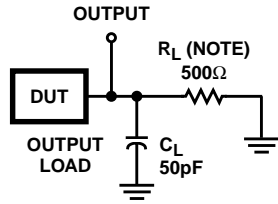

FIGURE 4.

**CD54/74AC164, CD54/74ACT164**



NOTE: For AC Series Only: When  $V_{CC} = 1.5V$ ,  $R_L = 1k\Omega$ .

	AC	ACT
Input Level	$V_{CC}$	3V
Input Switching Voltage, $V_S$	$0.5 V_{CC}$	1.5V
Output Switching Voltage, $V_S$	$0.5 V_{CC}$	$0.5 V_{CC}$

**FIGURE 5. PROPAGATION DELAY TIMES**

**PACKAGING INFORMATION**

Orderable Device	Status <sup>(1)</sup>	Package Type	Package Drawing	Pins	Package Qty	Eco Plan <sup>(2)</sup>	Lead/Ball Finish	MSL Peak Temp <sup>(3)</sup>
CD54AC164F3A	ACTIVE	CDIP	J	14	1	TBD	A42	N / A for Pkg Type
CD54ACT164F3A	ACTIVE	CDIP	J	14	1	TBD	A42	N / A for Pkg Type
CD74AC164E	ACTIVE	PDIP	N	14	25	Pb-Free (RoHS)	CU NIPDAU	N / A for Pkg Type
CD74AC164EE4	ACTIVE	PDIP	N	14	25	Pb-Free (RoHS)	CU NIPDAU	N / A for Pkg Type
CD74AC164M	ACTIVE	SOIC	D	14	50	Green (RoHS & no Sb/Br)	CU NIPDAU	Level-1-260C-UNLIM
CD74AC164M96	ACTIVE	SOIC	D	14	2500	Green (RoHS & no Sb/Br)	CU NIPDAU	Level-1-260C-UNLIM
CD74AC164M96E4	ACTIVE	SOIC	D	14	2500	Green (RoHS & no Sb/Br)	CU NIPDAU	Level-1-260C-UNLIM
CD74AC164M96G4	ACTIVE	SOIC	D	14	2500	Green (RoHS & no Sb/Br)	CU NIPDAU	Level-1-260C-UNLIM
CD74AC164ME4	ACTIVE	SOIC	D	14	50	Green (RoHS & no Sb/Br)	CU NIPDAU	Level-1-260C-UNLIM
CD74AC164MG4	ACTIVE	SOIC	D	14	50	Green (RoHS & no Sb/Br)	CU NIPDAU	Level-1-260C-UNLIM
CD74ACT164E	ACTIVE	PDIP	N	14	25	Pb-Free (RoHS)	CU NIPDAU	N / A for Pkg Type
CD74ACT164EE4	ACTIVE	PDIP	N	14	25	Pb-Free (RoHS)	CU NIPDAU	N / A for Pkg Type
CD74ACT164M	ACTIVE	SOIC	D	14	50	Green (RoHS & no Sb/Br)	CU NIPDAU	Level-1-260C-UNLIM
CD74ACT164M96	ACTIVE	SOIC	D	14	2500	Green (RoHS & no Sb/Br)	CU NIPDAU	Level-1-260C-UNLIM
CD74ACT164M96E4	ACTIVE	SOIC	D	14	2500	Green (RoHS & no Sb/Br)	CU NIPDAU	Level-1-260C-UNLIM
CD74ACT164M96G4	ACTIVE	SOIC	D	14	2500	Green (RoHS & no Sb/Br)	CU NIPDAU	Level-1-260C-UNLIM
CD74ACT164ME4	ACTIVE	SOIC	D	14	50	Green (RoHS & no Sb/Br)	CU NIPDAU	Level-1-260C-UNLIM
CD74ACT164MG4	ACTIVE	SOIC	D	14	50	Green (RoHS & no Sb/Br)	CU NIPDAU	Level-1-260C-UNLIM

<sup>(1)</sup> The marketing status values are defined as follows:

**ACTIVE:** Product device recommended for new designs.

**LIFEBUY:** TI has announced that the device will be discontinued, and a lifetime-buy period is in effect.

**NRND:** Not recommended for new designs. Device is in production to support existing customers, but TI does not recommend using this part in a new design.

**PREVIEW:** Device has been announced but is not in production. Samples may or may not be available.

**OBSELETE:** TI has discontinued the production of the device.

<sup>(2)</sup> Eco Plan - The planned eco-friendly classification: Pb-Free (RoHS), Pb-Free (RoHS Exempt), or Green (RoHS & no Sb/Br) - please check <http://www.ti.com/productcontent> for the latest availability information and additional product content details.

**TBD:** The Pb-Free/Green conversion plan has not been defined.

**Pb-Free (RoHS):** TI's terms "Lead-Free" or "Pb-Free" mean semiconductor products that are compatible with the current RoHS requirements for all 6 substances, including the requirement that lead not exceed 0.1% by weight in homogeneous materials. Where designed to be soldered at high temperatures, TI Pb-Free products are suitable for use in specified lead-free processes.

**Pb-Free (RoHS Exempt):** This component has a RoHS exemption for either 1) lead-based flip-chip solder bumps used between the die and package, or 2) lead-based die adhesive used between the die and leadframe. The component is otherwise considered Pb-Free (RoHS compatible) as defined above.



**Green (RoHS & no Sb/Br):** TI defines "Green" to mean Pb-Free (RoHS compatible), and free of Bromine (Br) and Antimony (Sb) based flame retardants (Br or Sb do not exceed 0.1% by weight in homogeneous material)

<sup>(3)</sup> MSL, Peak Temp. -- The Moisture Sensitivity Level rating according to the JEDEC industry standard classifications, and peak solder temperature.

**Important Information and Disclaimer:**The information provided on this page represents TI's knowledge and belief as of the date that it is provided. TI bases its knowledge and belief on information provided by third parties, and makes no representation or warranty as to the accuracy of such information. Efforts are underway to better integrate information from third parties. TI has taken and continues to take reasonable steps to provide representative and accurate information but may not have conducted destructive testing or chemical analysis on incoming materials and chemicals. TI and TI suppliers consider certain information to be proprietary, and thus CAS numbers and other limited information may not be available for release.

In no event shall TI's liability arising out of such information exceed the total purchase price of the TI part(s) at issue in this document sold by TI to Customer on an annual basis.

**TAPE AND REEL INFORMATION**
**REEL DIMENSIONS**

**TAPE DIMENSIONS**

A0	Dimension designed to accommodate the component width
B0	Dimension designed to accommodate the component length
K0	Dimension designed to accommodate the component thickness
W	Overall width of the carrier tape
P1	Pitch between successive cavity centers

**TAPE AND REEL INFORMATION**

\*All dimensions are nominal

Device	Package Type	Package Drawing	Pins	SPQ	Reel Diameter (mm)	Reel Width W1 (mm)	A0 (mm)	B0 (mm)	K0 (mm)	P1 (mm)	W (mm)	Pin1 Quadrant
CD74AC164M96	SOIC	D	14	2500	330.0	16.4	6.5	9.0	2.1	8.0	16.0	Q1
CD74ACT164M96	SOIC	D	14	2500	330.0	16.4	6.5	9.0	2.1	8.0	16.0	Q1

**TAPE AND REEL BOX DIMENSIONS**

\*All dimensions are nominal

Device	Package Type	Package Drawing	Pins	SPQ	Length (mm)	Width (mm)	Height (mm)
CD74AC164M96	SOIC	D	14	2500	367.0	367.0	38.0
CD74ACT164M96	SOIC	D	14	2500	367.0	367.0	38.0

J (R-GDIP-T\*\*)

14 LEADS SHOWN

CERAMIC DUAL IN-LINE PACKAGE



DIM \ PINS **	14	16	18	20
A	0.300 (7,62) BSC	0.300 (7,62) BSC	0.300 (7,62) BSC	0.300 (7,62) BSC
B MAX	0.785 (19,94)	.840 (21,34)	0.960 (24,38)	1.060 (26,92)
B MIN	—	—	—	—
C MAX	0.300 (7,62)	0.300 (7,62)	0.310 (7,87)	0.300 (7,62)
C MIN	0.245 (6,22)	0.245 (6,22)	0.220 (5,59)	0.245 (6,22)



4040083/F 03/03

- NOTES:
- All linear dimensions are in inches (millimeters).
  - This drawing is subject to change without notice.
  - This package is hermetically sealed with a ceramic lid using glass frit.
  - Index point is provided on cap for terminal identification only on press ceramic glass frit seal only.
  - Falls within MIL STD 1835 GDIP1-T14, GDIP1-T16, GDIP1-T18 and GDIP1-T20.

N (R-PDIP-T\*\*)

PLASTIC DUAL-IN-LINE PACKAGE

16 PINS SHOWN



- NOTES:
- A. All linear dimensions are in inches (millimeters).
  - B. This drawing is subject to change without notice.
  - Falls within JEDEC MS-001, except 18 and 20 pin minimum body length (Dim A).
  - The 20 pin end lead shoulder width is a vendor option, either half or full width.

D (R-PDSO-G14)

PLASTIC SMALL OUTLINE



- NOTES:
- A. All linear dimensions are in inches (millimeters).
  - B. This drawing is subject to change without notice.
  - $\triangle C$  Body length does not include mold flash, protrusions, or gate burrs. Mold flash, protrusions, or gate burrs shall not exceed 0.006 (0,15) each side.
  - $\triangle D$  Body width does not include interlead flash. Interlead flash shall not exceed 0.017 (0,43) each side.
  - E. Reference JEDEC MS-012 variation AB.

D (R-PDSO-G14)

PLASTIC SMALL OUTLINE

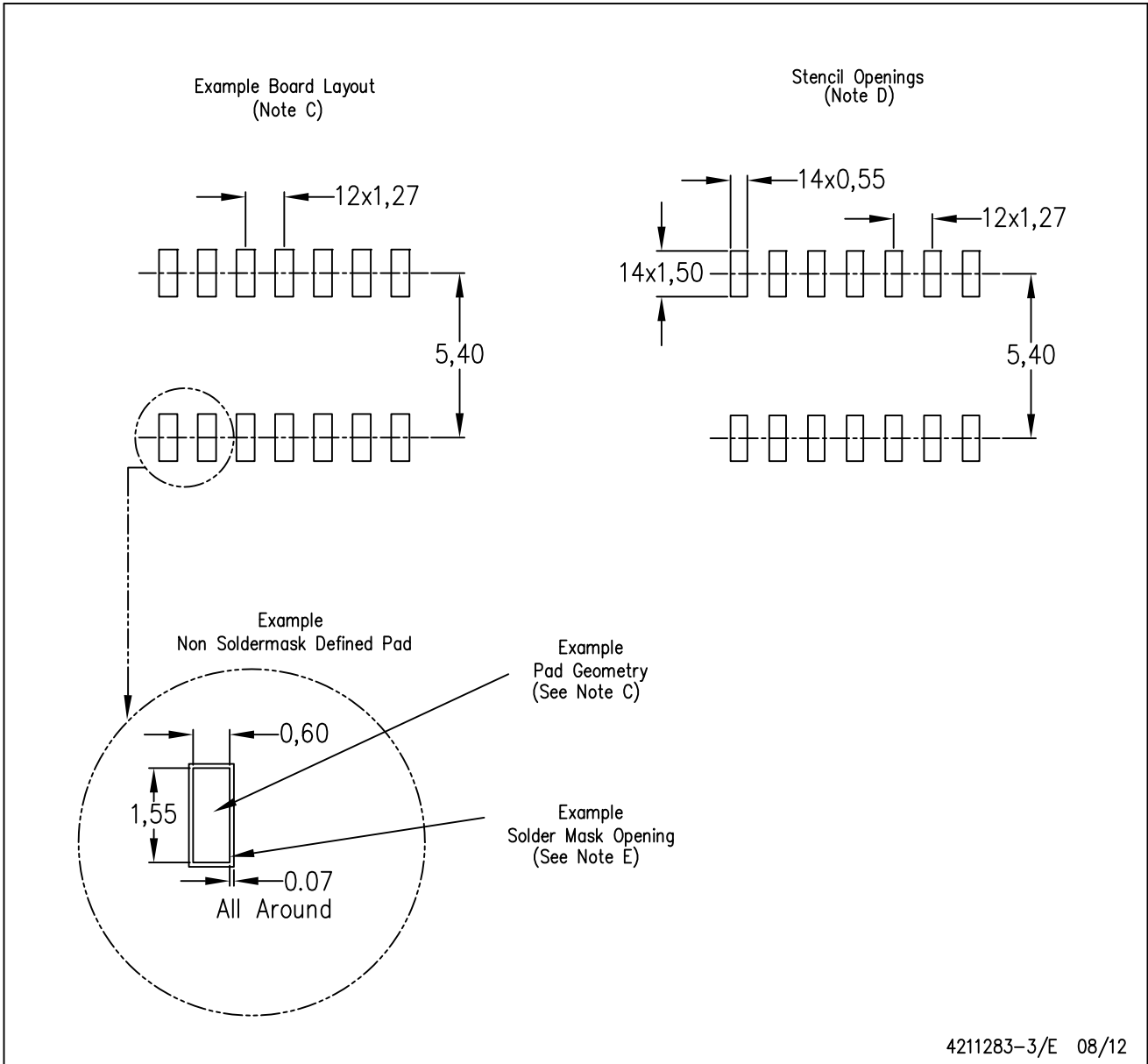

- NOTES:
- A. All linear dimensions are in millimeters.
  - B. This drawing is subject to change without notice.
  - C. Publication IPC-7351 is recommended for alternate designs.
  - D. Laser cutting apertures with trapezoidal walls and also rounding corners will offer better paste release. Customers should contact their board assembly site for stencil design recommendations. Refer to IPC-7525 for other stencil recommendations.
  - E. Customers should contact their board fabrication site for solder mask tolerances between and around signal pads.

## IMPORTANT NOTICE

Texas Instruments Incorporated and its subsidiaries (TI) reserve the right to make corrections, enhancements, improvements and other changes to its semiconductor products and services per JESD46, latest issue, and to discontinue any product or service per JESD48, latest issue. Buyers should obtain the latest relevant information before placing orders and should verify that such information is current and complete. All semiconductor products (also referred to herein as "components") are sold subject to TI's terms and conditions of sale supplied at the time of order acknowledgment.

TI warrants performance of its components to the specifications applicable at the time of sale, in accordance with the warranty in TI's terms and conditions of sale of semiconductor products. Testing and other quality control techniques are used to the extent TI deems necessary to support this warranty. Except where mandated by applicable law, testing of all parameters of each component is not necessarily performed.

TI assumes no liability for applications assistance or the design of Buyers' products. Buyers are responsible for their products and applications using TI components. To minimize the risks associated with Buyers' products and applications, Buyers should provide adequate design and operating safeguards.

TI does not warrant or represent that any license, either express or implied, is granted under any patent right, copyright, mask work right, or other intellectual property right relating to any combination, machine, or process in which TI components or services are used. Information published by TI regarding third-party products or services does not constitute a license to use such products or services or a warranty or endorsement thereof. Use of such information may require a license from a third party under the patents or other intellectual property of the third party, or a license from TI under the patents or other intellectual property of TI.

Reproduction of significant portions of TI information in TI data books or data sheets is permissible only if reproduction is without alteration and is accompanied by all associated warranties, conditions, limitations, and notices. TI is not responsible or liable for such altered documentation. Information of third parties may be subject to additional restrictions.

Resale of TI components or services with statements different from or beyond the parameters stated by TI for that component or service voids all express and any implied warranties for the associated TI component or service and is an unfair and deceptive business practice. TI is not responsible or liable for any such statements.

Buyer acknowledges and agrees that it is solely responsible for compliance with all legal, regulatory and safety-related requirements concerning its products, and any use of TI components in its applications, notwithstanding any applications-related information or support that may be provided by TI. Buyer represents and agrees that it has all the necessary expertise to create and implement safeguards which anticipate dangerous consequences of failures, monitor failures and their consequences, lessen the likelihood of failures that might cause harm and take appropriate remedial actions. Buyer will fully indemnify TI and its representatives against any damages arising out of the use of any TI components in safety-critical applications.

In some cases, TI components may be promoted specifically to facilitate safety-related applications. With such components, TI's goal is to help enable customers to design and create their own end-product solutions that meet applicable functional safety standards and requirements. Nonetheless, such components are subject to these terms.

No TI components are authorized for use in FDA Class III (or similar life-critical medical equipment) unless authorized officers of the parties have executed a special agreement specifically governing such use.

Only those TI components which TI has specifically designated as military grade or "enhanced plastic" are designed and intended for use in military/aerospace applications or environments. Buyer acknowledges and agrees that any military or aerospace use of TI components which have **not** been so designated is solely at the Buyer's risk, and that Buyer is solely responsible for compliance with all legal and regulatory requirements in connection with such use.

TI has specifically designated certain components which meet ISO/TS16949 requirements, mainly for automotive use. Components which have not been so designated are neither designed nor intended for automotive use; and TI will not be responsible for any failure of such components to meet such requirements.

### Products

Audio	<a href="http://www.ti.com/audio">www.ti.com/audio</a>
Amplifiers	<a href="http://amplifier.ti.com">amplifier.ti.com</a>
Data Converters	<a href="http://dataconverter.ti.com">dataconverter.ti.com</a>
DLP® Products	<a href="http://www.dlp.com">www.dlp.com</a>
DSP	<a href="http://dsp.ti.com">dsp.ti.com</a>
Clocks and Timers	<a href="http://www.ti.com/clocks">www.ti.com/clocks</a>
Interface	<a href="http://interface.ti.com">interface.ti.com</a>
Logic	<a href="http://logic.ti.com">logic.ti.com</a>
Power Mgmt	<a href="http://power.ti.com">power.ti.com</a>
Microcontrollers	<a href="http://microcontroller.ti.com">microcontroller.ti.com</a>
RFID	<a href="http://www.ti-rfid.com">www.ti-rfid.com</a>
OMAP Applications Processors	<a href="http://www.ti.com/omap">www.ti.com/omap</a>
Wireless Connectivity	<a href="http://www.ti.com/wirelessconnectivity">www.ti.com/wirelessconnectivity</a>

### Applications

Automotive and Transportation	<a href="http://www.ti.com/automotive">www.ti.com/automotive</a>
Communications and Telecom	<a href="http://www.ti.com/communications">www.ti.com/communications</a>
Computers and Peripherals	<a href="http://www.ti.com/computers">www.ti.com/computers</a>
Consumer Electronics	<a href="http://www.ti.com/consumer-apps">www.ti.com/consumer-apps</a>
Energy and Lighting	<a href="http://www.ti.com/energy">www.ti.com/energy</a>
Industrial	<a href="http://www.ti.com/industrial">www.ti.com/industrial</a>
Medical	<a href="http://www.ti.com/medical">www.ti.com/medical</a>
Security	<a href="http://www.ti.com/security">www.ti.com/security</a>
Space, Avionics and Defense	<a href="http://www.ti.com/space-avionics-defense">www.ti.com/space-avionics-defense</a>
Video and Imaging	<a href="http://www.ti.com/video">www.ti.com/video</a>
<b>TI E2E Community</b>	<a href="http://e2e.ti.com">e2e.ti.com</a>