

# SN54AHC374, SN74AHC374 OCTAL EDGE-TRIGGERED D-TYPE FLIP-FLOPS WITH 3-STATE OUTPUTS

SCLS240I – OCTOBER 1995 – REVISED JULY 2003

- Operating Range 2-V to 5.5-V  $V_{CC}$
- 3-State Outputs Drive Bus Lines Directly
- Latch-Up Performance Exceeds 250 mA Per JESD 17
- ESD Protection Exceeds JESD 22
  - 2000-V Human-Body Model (A114-A)
  - 200-V Machine Model (A115-A)
  - 1000-V Charged-Device Model (C101)

SN54AHC374 . . . J OR W PACKAGE  
SN74AHC374 . . . DB, DGV, DW, N, NS, OR PW PACKAGE  
(TOP VIEW)

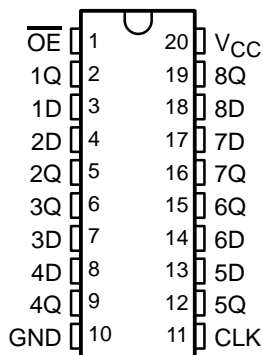

SN54AHC374 . . . FK PACKAGE  
(TOP VIEW)

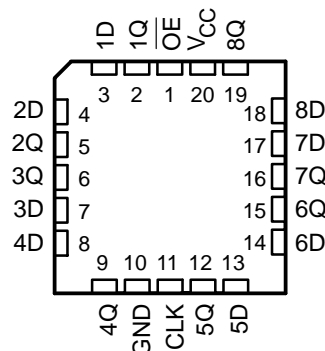

## description/ordering information

The 'AHC374 devices are octal edge-triggered D-type flip-flops that feature 3-state outputs designed specifically for driving highly capacitive or relatively low-impedance loads. These devices are particularly suitable for implementing buffer registers, I/O ports, bidirectional bus drivers, and working registers.

On the positive transition of the clock (CLK) input, the Q outputs are set to the logic levels of the data (D) inputs.

A buffered output-enable ( $\overline{OE}$ ) input can be used to place the eight outputs in either a normal logic state (high or low) or the high-impedance state. In the high-impedance state, the outputs neither load nor drive the bus lines significantly. The high-impedance state and the increased drive provide the capability to drive bus lines without interface or pullup components.

## ORDERING INFORMATION

$T_A$	PACKAGE†		ORDERABLE PART NUMBER	TOP-SIDE MARKING
–40°C to 85°C	PDIP – N	Tube	SN74AHC374N	SN74AHC374N
	SOIC – DW	Tube	SN74AHC374DW	AHC374
		Tape and reel	SN74AHC374DWR	
	SOP – NS	Tape and reel	SN74AHC374NSR	AHC374
	SSOP – DB	Tape and reel	SN74AHC374DBR	HA374
	TSSOP – PW	Tube	SN74AHC374PW	HA374
		Tape and reel	SN74AHC374PWR	
TVSOP – DGV	Tape and reel	SN74AHC374DGVR	HA374	
–55°C to 125°C	CDIP – J	Tube	SNJ54AHC374J	SNJ54AHC374J
	CFP – W	Tube	SNJ54AHC374W	SNJ54AHC374W
	LCCC – FK	Tube	SNJ54AHC374FK	SNJ54AHC374FK

† Package drawings, standard packing quantities, thermal data, symbolization, and PCB design guidelines are available at [www.ti.com/sc/package](http://www.ti.com/sc/package).



Please be aware that an important notice concerning availability, standard warranty, and use in critical applications of Texas Instruments semiconductor products and disclaimers thereto appears at the end of this data sheet.

PRODUCTION DATA information is current as of publication date. Products conform to specifications per the terms of Texas Instruments standard warranty. Production processing does not necessarily include testing of all parameters.

 **TEXAS  
INSTRUMENTS**

POST OFFICE BOX 655303 • DALLAS, TEXAS 75265

Copyright © 2003, Texas Instruments Incorporated  
On products compliant to MIL-PRF-38535, all parameters are tested unless otherwise noted. On all other products, production processing does not necessarily include testing of all parameters.

# SN54AHC374, SN74AHC374 OCTAL EDGE-TRIGGERED D-TYPE FLIP-FLOPS WITH 3-STATE OUTPUTS

SCLS240I – OCTOBER 1995 – REVISED JULY 2003

## description/ordering information (continued)

$\overline{OE}$  does not affect internal operations of the flip-flop. Old data can be retained or new data can be entered while the outputs are in the high-impedance state.

To ensure the high-impedance state during power up or power down,  $\overline{OE}$  should be tied to  $V_{CC}$  through a pullup resistor; the minimum value of the resistor is determined by the current-sinking capability of the driver.

FUNCTION TABLE  
(each flip-flop)

INPUTS			OUTPUT
$\overline{OE}$	CLK	D	Q
L	↑	H	H
L	↑	L	L
L	H or L	X	$Q_0$
H	X	X	Z

## logic diagram (positive logic)

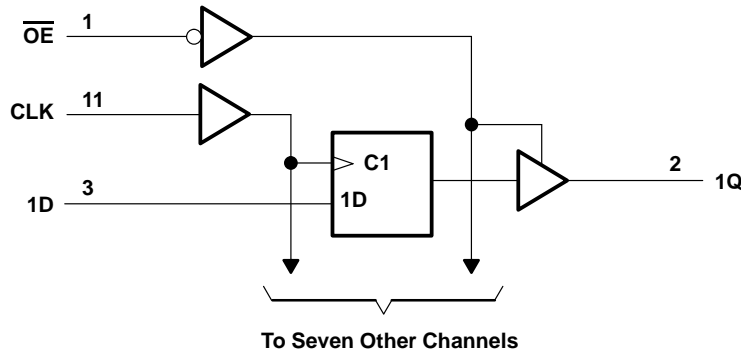

# SN54AHC374, SN74AHC374 OCTAL EDGE-TRIGGERED D-TYPE FLIP-FLOPS WITH 3-STATE OUTPUTS

SCLS240I – OCTOBER 1995 – REVISED JULY 2003

## absolute maximum ratings over operating free-air temperature range (unless otherwise noted)†

Supply voltage range, $V_{CC}$ .....	–0.5 V to 7 V
Input voltage range, $V_I$ (see Note 1) .....	–0.5 V to 7 V
Output voltage range, $V_O$ (see Note 1) .....	–0.5 V to $V_{CC} + 0.5$ V
Input clamp current, $I_{IK}$ ( $V_I < 0$ ) .....	–20 mA
Output clamp current, $I_{OK}$ ( $V_O < 0$ or $V_O > V_{CC}$ ) .....	±20 mA
Continuous output current, $I_O$ ( $V_O = 0$ to $V_{CC}$ ) .....	±25 mA
Continuous current through $V_{CC}$ or GND .....	±75 mA
Package thermal impedance, $\theta_{JA}$ (see Note 2): DB package .....	70°C/W
DGV package .....	92°C/W
DW package .....	58°C/W
N package .....	69°C/W
NS package .....	60°C/W
PW package .....	83°C/W
Storage temperature range, $T_{stg}$ .....	–65°C to 150°C

† Stresses beyond those listed under “absolute maximum ratings” may cause permanent damage to the device. These are stress ratings only, and functional operation of the device at these or any other conditions beyond those indicated under “recommended operating conditions” is not implied. Exposure to absolute-maximum-rated conditions for extended periods may affect device reliability.

- NOTES: 1. The input and output voltage ratings may be exceeded if the input and output current ratings are observed.  
2. The package thermal impedance is calculated in accordance with JESD 51-7.

## recommended operating conditions (see Note 3)

		SN54AHC374		SN74AHC374		UNIT
		MIN	MAX	MIN	MAX	
$V_{CC}$	Supply voltage	2	5.5	2	5.5	V
$V_{IH}$	High-level input voltage	$V_{CC} = 2$ V		1.5		V
		$V_{CC} = 3$ V		2.1		
		$V_{CC} = 5.5$ V		3.85		
$V_{IL}$	Low-level input voltage	$V_{CC} = 2$ V		0.5		V
		$V_{CC} = 3$ V		0.9		
		$V_{CC} = 5.5$ V		1.65		
$V_I$	Input voltage	0	5.5	0	5.5	V
$V_O$	Output voltage	0	$V_{CC}$	0	$V_{CC}$	V
$I_{OH}$	High-level output current	$V_{CC} = 2$ V		–50		$\mu$ A
		$V_{CC} = 3.3$ V ± 0.3 V		–4		mA
		$V_{CC} = 5$ V ± 0.5 V		–8		
$I_{OL}$	Low-level output current	$V_{CC} = 2$ V		50		$\mu$ A
		$V_{CC} = 3.3$ V ± 0.3 V		4		mA
		$V_{CC} = 5$ V ± 0.5 V		8		
$\Delta t/\Delta v$	Input transition rise or fall rate	$V_{CC} = 3.3$ V ± 0.3 V		100		ns/V
		$V_{CC} = 5$ V ± 0.5 V		20		
$T_A$	Operating free-air temperature	–55	125	–40	85	°C

NOTE 3: All unused inputs of the device must be held at  $V_{CC}$  or GND to ensure proper device operation. Refer to the TI application report, *Implications of Slow or Floating CMOS Inputs*, literature number SCBA004.



**SN54AHC374, SN74AHC374**  
**OCTAL EDGE-TRIGGERED D-TYPE FLIP-FLOPS**  
**WITH 3-STATE OUTPUTS**

SCLS240I – OCTOBER 1995 – REVISED JULY 2003

**electrical characteristics over recommended operating free-air temperature range (unless otherwise noted)**

PARAMETER	TEST CONDITIONS	V <sub>CC</sub>	T <sub>A</sub> = 25°C			SN54AHC374		SN74AHC374		UNIT
			MIN	TYP	MAX	MIN	MAX	MIN	MAX	
V <sub>OH</sub>	I <sub>OH</sub> = -50 μA	2 V	1.9	2		1.9		1.9	V	
		3 V	2.9	3		2.9		2.9		
		4.5 V	4.4	4.5		4.4		4.4		
	I <sub>OH</sub> = -4 mA	3 V	2.58			2.48		2.48		
	I <sub>OH</sub> = -8 mA	4.5 V	3.94			3.8		3.8		
V <sub>OL</sub>	I <sub>OL</sub> = 50 μA	2 V			0.1		0.1	0.1	V	
		3 V			0.1		0.1	0.1		
		4.5 V			0.1		0.1	0.1		
	I <sub>OL</sub> = 4 mA	3 V			0.36		0.5	0.44		
	I <sub>OL</sub> = 8 mA	4.5 V			0.36		0.5	0.44		
I <sub>I</sub>	V <sub>I</sub> = 5.5 V or GND	0 V to 5.5 V			±0.1		±1*	±1	μA	
I <sub>OZ</sub>	V <sub>O</sub> = V <sub>CC</sub> or GND	5.5 V			±0.25		±2.5	±2.5	μA	
I <sub>CC</sub>	V <sub>I</sub> = V <sub>CC</sub> or GND, I <sub>O</sub> = 0	5.5 V			4		40	40	μA	
C <sub>i</sub>	V <sub>I</sub> = V <sub>CC</sub> or GND	5 V			4	10		10	pF	
C <sub>o</sub>	V <sub>O</sub> = V <sub>CC</sub> or GND	5 V			6				pF	

\* On products compliant to MIL-PRF-38535, this parameter is not production tested at V<sub>CC</sub> = 0 V.

**timing requirements over recommended operating free-air temperature range, V<sub>CC</sub> = 3.3 V ± 0.3 V (unless otherwise noted) (see Figure 1)**

		T <sub>A</sub> = 25°C		SN54AHC374		SN74AHC374		UNIT
		MIN	MAX	MIN	MAX	MIN	MAX	
t <sub>w</sub>	Pulse duration, CLK high or low	5		5.5		5.5		ns
t <sub>su</sub>	Setup time, data before CLK↑	4.5		4		4		ns
t <sub>h</sub>	Hold time, data after CLK↑	2		2		2		ns

**timing requirements over recommended operating free-air temperature range, V<sub>CC</sub> = 5 V ± 0.5 V (unless otherwise noted) (see Figure 1)**

		T <sub>A</sub> = 25°C		SN54AHC374		SN74AHC374		UNIT
		MIN	MAX	MIN	MAX	MIN	MAX	
t <sub>w</sub>	Pulse duration, CLK high or low	5		5		5		ns
t <sub>su</sub>	Setup time, data before CLK↑	3		3		3		ns
t <sub>h</sub>	Hold time, data after CLK↑	2		2		2		ns



# SN54AHC374, SN74AHC374 OCTAL EDGE-TRIGGERED D-TYPE FLIP-FLOPS WITH 3-STATE OUTPUTS

SCLS240I – OCTOBER 1995 – REVISED JULY 2003

**switching characteristics over recommended operating free-air temperature range,  
V<sub>CC</sub> = 3.3 V ± 0.3 V (unless otherwise noted) (see Figure 1)**

PARAMETER	FROM (INPUT)	TO (OUTPUT)	LOAD CAPACITANCE	T <sub>A</sub> = 25°C			SN54AHC374		SN74AHC374		UNIT
				MIN	TYP	MAX	MIN	MAX	MIN	MAX	
f <sub>max</sub>			C <sub>L</sub> = 15 pF	80*	130*		70*		70		MHz
			C <sub>L</sub> = 50 pF	55	85		50		50		
t <sub>PLH</sub>	CLK	Q	C <sub>L</sub> = 15 pF	8.1*	12.7*		1*	15*	1	15	ns
t <sub>PHL</sub>				8.1*	12.7*		1*	15*	1	15	
t <sub>PZH</sub>	$\overline{OE}$	Q	C <sub>L</sub> = 15 pF	7.1*	11*		1*	13*	1	13	ns
t <sub>PZL</sub>				7.1*	11*		1*	13*	1	13	
t <sub>PHZ</sub>	$\overline{OE}$	Q	C <sub>L</sub> = 15 pF	7.5*	10.5*		1*	12.5*	1	12.5	ns
t <sub>PLZ</sub>				7.5*	10.5*		1*	12.5*	1	12.5	
t <sub>PLH</sub>	CLK	Q	C <sub>L</sub> = 50 pF	10.6	16.2		1	18.5	1	18.5	ns
t <sub>PHL</sub>				10.6	16.2		1	18.5	1	18.5	
t <sub>PZH</sub>	$\overline{OE}$	Q	C <sub>L</sub> = 50 pF	9.6	14.5		1	16.5	1	16.5	ns
t <sub>PZL</sub>				9.6	14.5		1	16.5	1	16.5	
t <sub>PHZ</sub>	$\overline{OE}$	Q	C <sub>L</sub> = 50 pF	10.2	14		1	16	1	16	ns
t <sub>PLZ</sub>				10.2	14		1	16	1	16	
t <sub>sk(o)</sub>			C <sub>L</sub> = 50 pF			1.5**				1.5	ns

\* On products compliant to MIL-PRF-38535, this parameter is not production tested.

\*\* On products compliant to MIL-PRF-38535, this parameter does not apply.

**switching characteristics over recommended operating free-air temperature range,  
V<sub>CC</sub> = 5 V ± 0.5 V (unless otherwise noted) (see Figure 1)**

PARAMETER	FROM (INPUT)	TO (OUTPUT)	LOAD CAPACITANCE	T <sub>A</sub> = 25°C			SN54AHC374		SN74AHC374		UNIT
				MIN	TYP	MAX	MIN	MAX	MIN	MAX	
f <sub>max</sub>			C <sub>L</sub> = 15 pF	130*	185*		110*		110		MHz
			C <sub>L</sub> = 50 pF	85	120		75		75		
t <sub>PLH</sub>	CLK	Q	C <sub>L</sub> = 15 pF	5.4*	8.1*		1*	9.5*	1	9.5	ns
t <sub>PHL</sub>				5.4*	8.1*		1*	9.5*	1	9.5	
t <sub>PZH</sub>	$\overline{OE}$	Q	C <sub>L</sub> = 15 pF	5.1*	7.6*		1*	9*	1	9	ns
t <sub>PZL</sub>				5.1*	7.6*		1*	9*	1	9	
t <sub>PHZ</sub>	$\overline{OE}$	Q	C <sub>L</sub> = 15 pF	4.6*	6.8*		1*	8*	1	8	ns
t <sub>PLZ</sub>				4.6*	6.8*		1*	8*	1	8	
t <sub>PLH</sub>	CLK	Q	C <sub>L</sub> = 50 pF	6.9	10.1		1	11.5	1	11.5	ns
t <sub>PHL</sub>				6.9	10.1		1	11.5	1	11.5	
t <sub>PZH</sub>	$\overline{OE}$	Q	C <sub>L</sub> = 50 pF	6.6	9.6		1	11	1	11	ns
t <sub>PZL</sub>				6.6	9.6		1	11	1	11	
t <sub>PHZ</sub>	$\overline{OE}$	Q	C <sub>L</sub> = 50 pF	6.1	8.8		1	10	1	10	ns
t <sub>PLZ</sub>				6.1	8.8		1	10	1	10	
t <sub>sk(o)</sub>			C <sub>L</sub> = 50 pF			1**				1	ns

\* On products compliant to MIL-PRF-38535, this parameter is not production tested.

\*\* On products compliant to MIL-PRF-38535, this parameter does not apply.



**SN54AHC374, SN74AHC374**  
**OCTAL EDGE-TRIGGERED D-TYPE FLIP-FLOPS**  
**WITH 3-STATE OUTPUTS**

SCLS240I – OCTOBER 1995 – REVISED JULY 2003

**noise characteristics,  $V_{CC} = 5\text{ V}$ ,  $C_L = 50\text{ pF}$ ,  $T_A = 25^\circ\text{C}$  (see Note 4)**

PARAMETER	SN74AHC374			UNIT
	MIN	TYP	MAX	
$V_{OL(P)}$ Quiet output, maximum dynamic $V_{OL}$		0.5	1	V
$V_{OL(V)}$ Quiet output, minimum dynamic $V_{OL}$		-0.5	-0.8	V
$V_{OH(V)}$ Quiet output, minimum dynamic $V_{OH}$		4		V
$V_{IH(D)}$ High-level dynamic input voltage		3.5		V
$V_{IL(D)}$ Low-level dynamic input voltage			1.5	V

NOTE 4: Characteristics are for surface-mount packages only.

**operating characteristics,  $V_{CC} = 5\text{ V}$ ,  $T_A = 25^\circ\text{C}$**

PARAMETER	TEST CONDITIONS	TYP	UNIT
$C_{pd}$ Power dissipation capacitance	No load, $f = 1\text{ MHz}$	32	pF



# SN54AHC374, SN74AHC374 OCTAL EDGE-TRIGGERED D-TYPE FLIP-FLOPS WITH 3-STATE OUTPUTS

SCLS240I – OCTOBER 1995 – REVISED JULY 2003

## PARAMETER MEASUREMENT INFORMATION

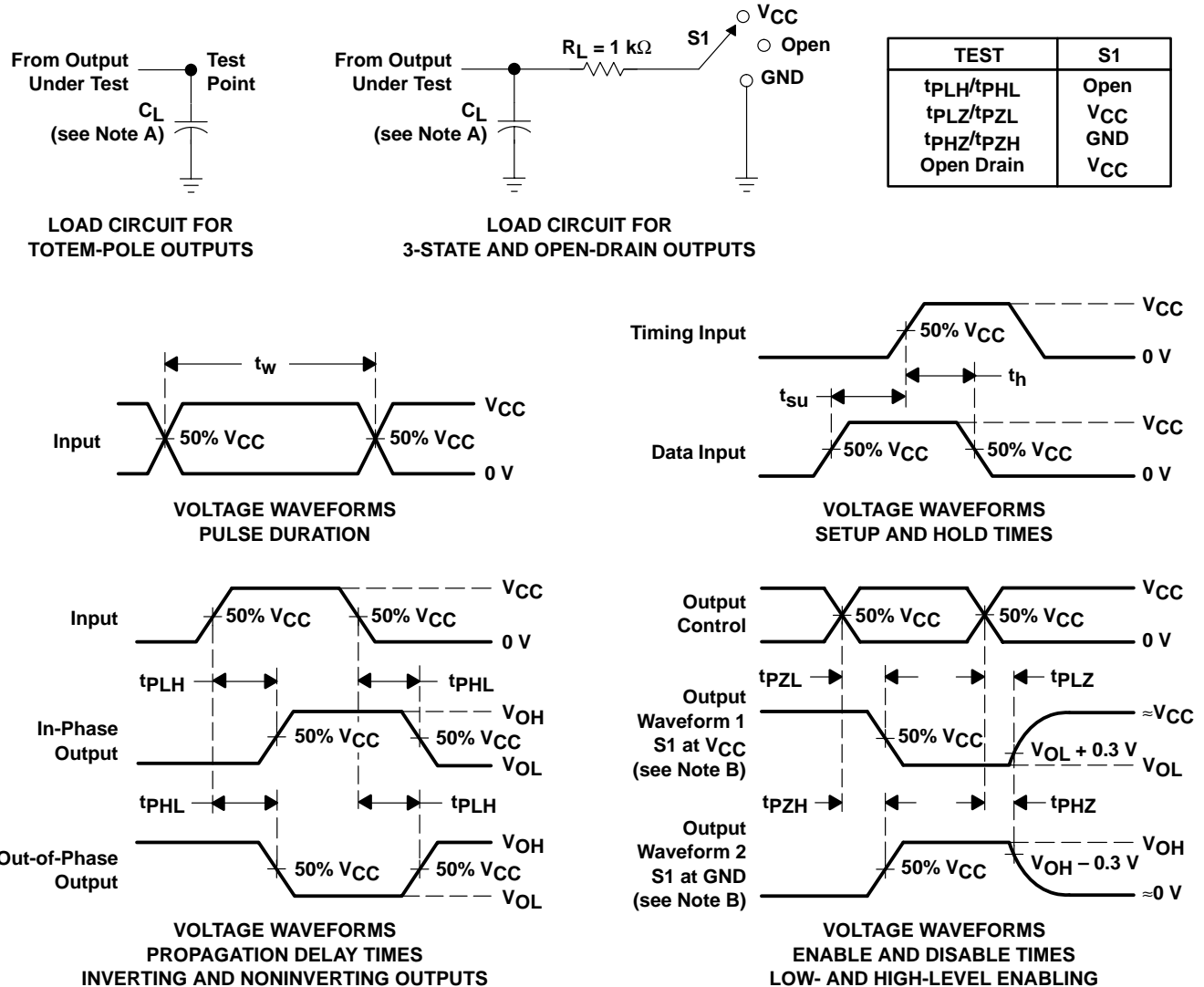

- NOTES: A.  $C_L$  includes probe and jig capacitance.  
 B. Waveform 1 is for an output with internal conditions such that the output is high except when disabled by the output control. Waveform 2 is for an output with internal conditions such that the output is low except when disabled by the output control.  
 C. All input pulses are supplied by generators having the following characteristics: PRR  $\leq 1\text{ MHz}$ ,  $Z_O = 50\ \Omega$ ,  $t_r \leq 3\text{ ns}$ ,  $t_f \leq 3\text{ ns}$ .  
 D. The outputs are measured one at a time with one input transition per measurement.  
 E. All parameters and waveforms are not applicable to all devices.

Figure 1. Load Circuit and Voltage Waveforms

J (R-GDIP-T\*\*)

14 LEADS SHOWN

CERAMIC DUAL IN-LINE PACKAGE



DIM \ PINS **	14	16	18	20
A	0.300 (7,62) BSC	0.300 (7,62) BSC	0.300 (7,62) BSC	0.300 (7,62) BSC
B MAX	0.785 (19,94)	.840 (21,34)	0.960 (24,38)	1.060 (26,92)
B MIN	—	—	—	—
C MAX	0.300 (7,62)	0.300 (7,62)	0.310 (7,87)	0.300 (7,62)
C MIN	0.245 (6,22)	0.245 (6,22)	0.220 (5,59)	0.245 (6,22)



4040083/F 03/03

- NOTES:
- All linear dimensions are in inches (millimeters).
  - This drawing is subject to change without notice.
  - This package is hermetically sealed with a ceramic lid using glass frit.
  - Index point is provided on cap for terminal identification only on press ceramic glass frit seal only.
  - Falls within MIL STD 1835 GDIP1-T14, GDIP1-T16, GDIP1-T18 and GDIP1-T20.



W (R-GDFP-F20)

CERAMIC DUAL FLATPACK

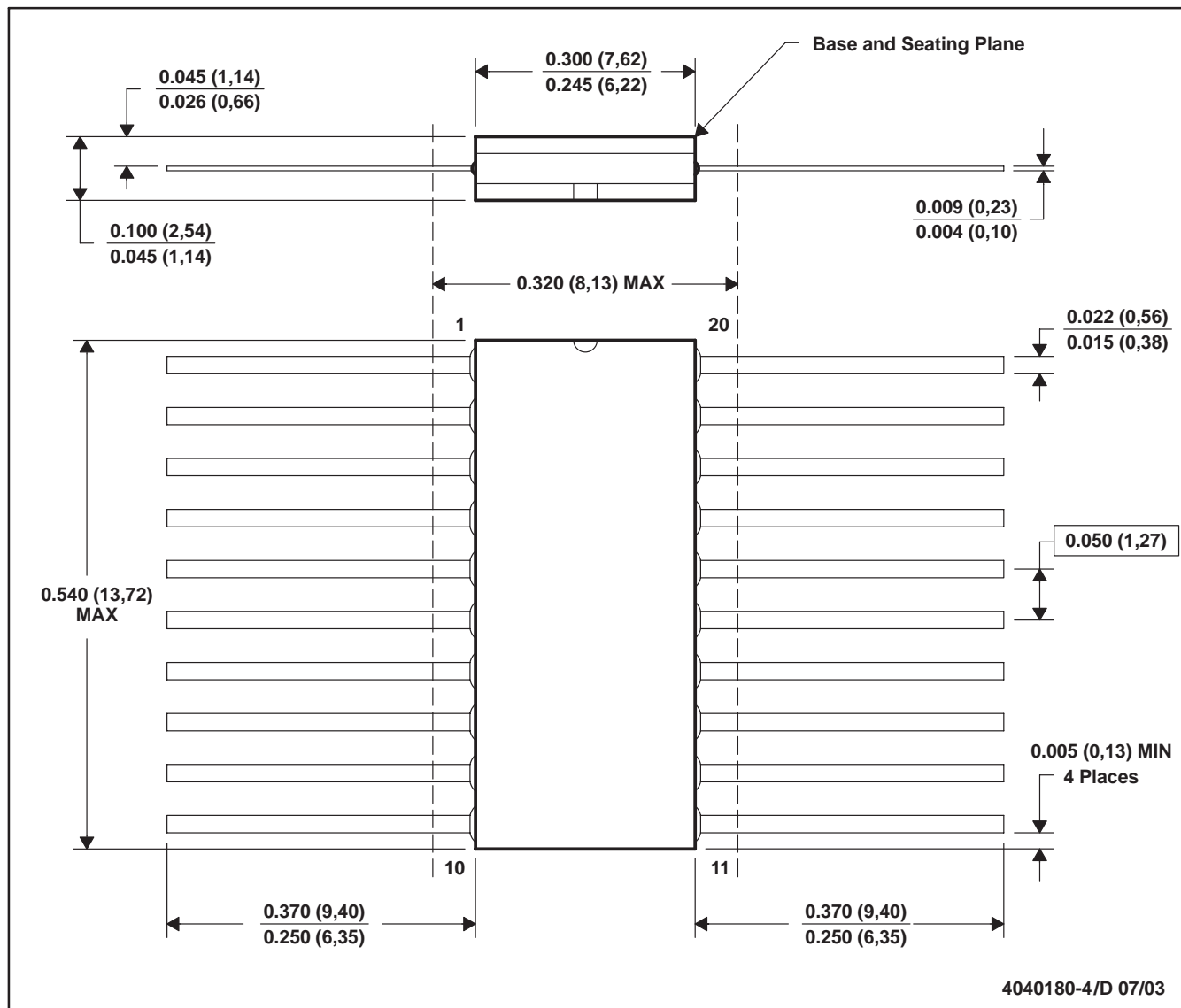

- NOTES: A. All linear dimensions are in inches (millimeters).  
 B. This drawing is subject to change without notice.  
 C. This package can be hermetically sealed with a ceramic lid using glass frit.  
 D. Index point is provided on cap for terminal identification only.  
 E. Falls within Mil-Std 1835 GDFP2-F20

FK (S-CQCC-N\*\*)

LEADLESS CERAMIC CHIP CARRIER

28 TERMINAL SHOWN

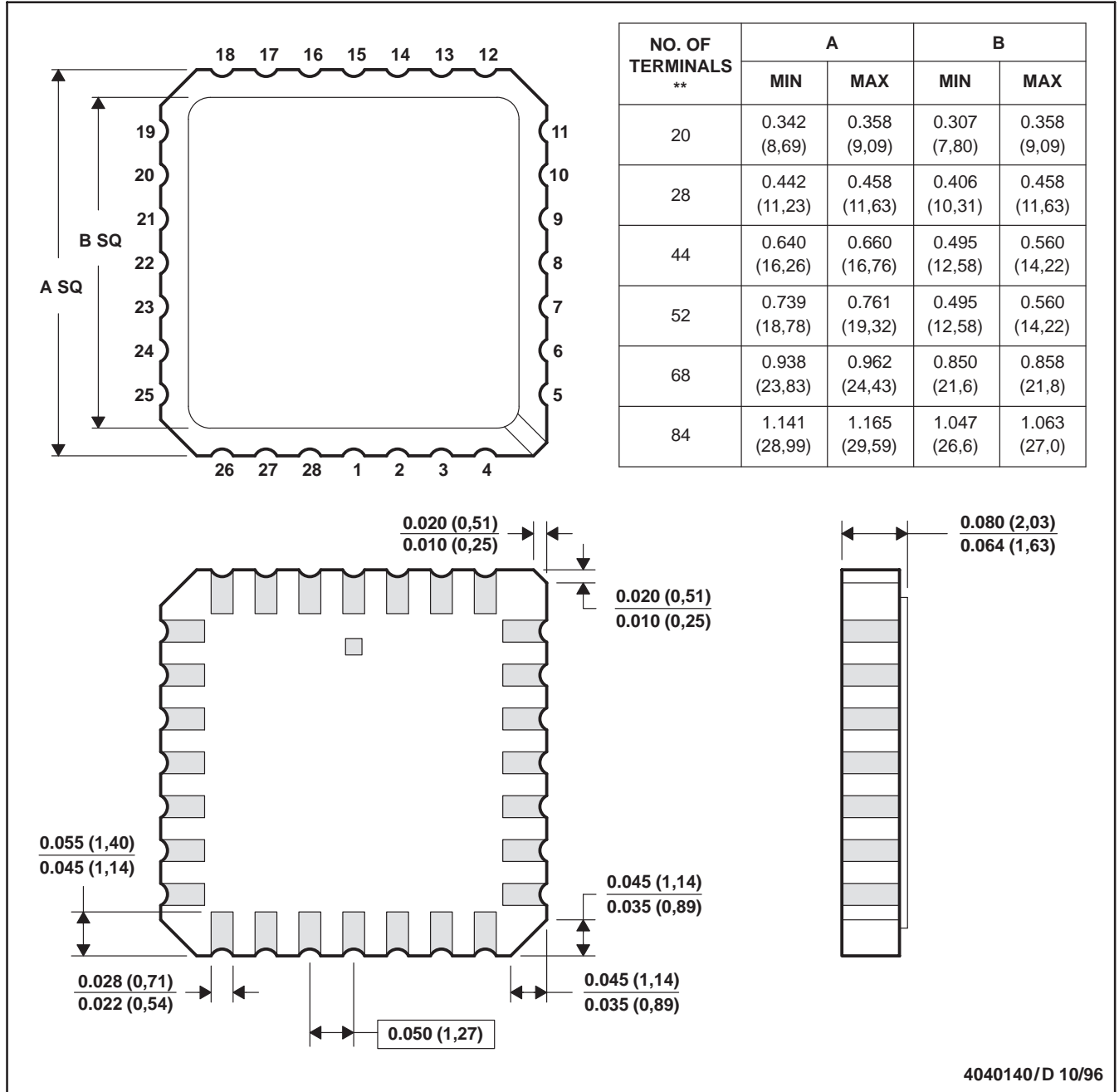

- NOTES:
- A. All linear dimensions are in inches (millimeters).
  - B. This drawing is subject to change without notice.
  - C. This package can be hermetically sealed with a metal lid.
  - D. The terminals are gold plated.
  - E. Falls within JEDEC MS-004

N (R-PDIP-T\*\*)

PLASTIC DUAL-IN-LINE PACKAGE

16 PINS SHOWN

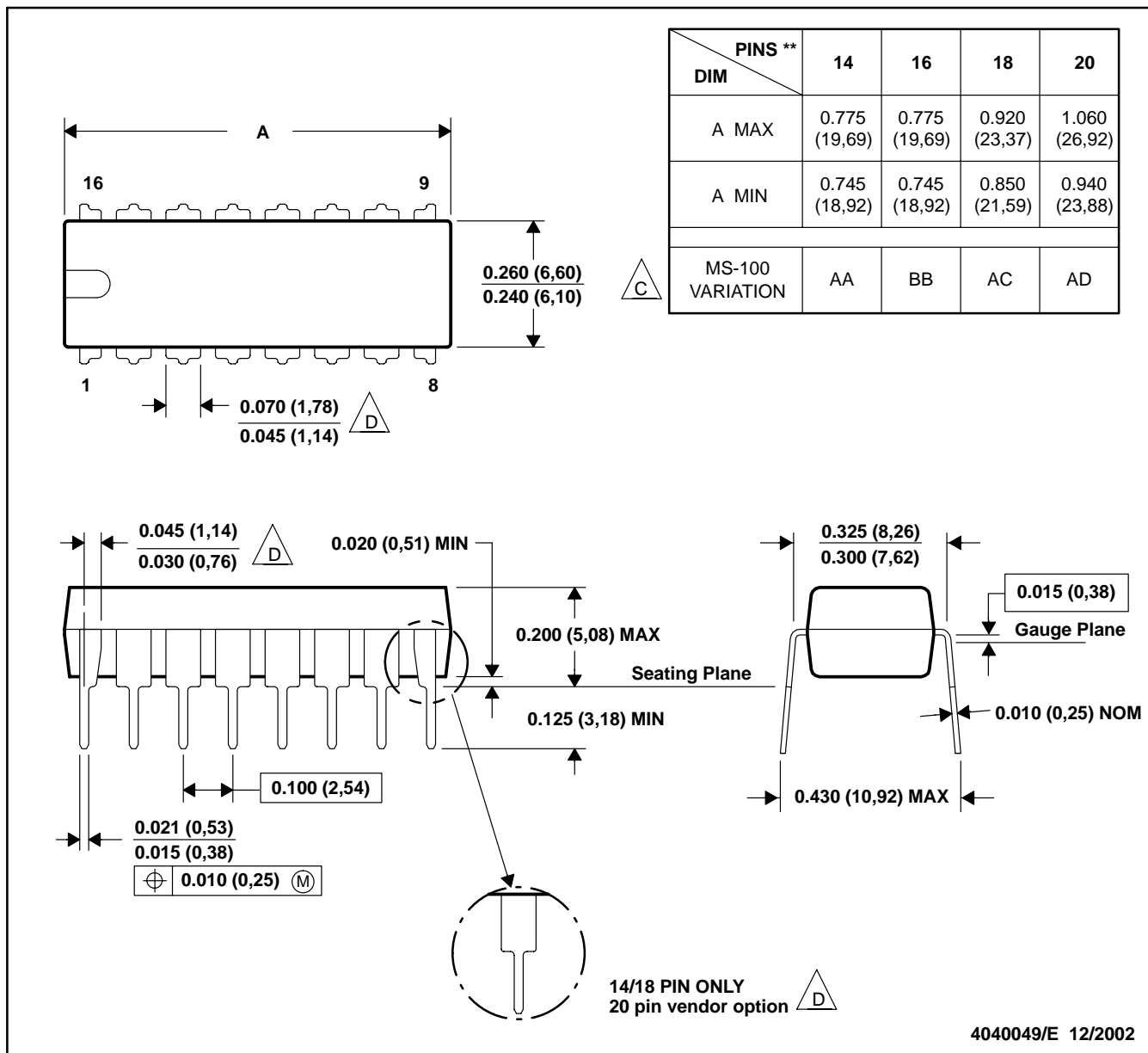

- NOTES: A. All linear dimensions are in inches (millimeters).  
 B. This drawing is subject to change without notice.  
 C Falls within JEDEC MS-001, except 18 and 20 pin minimum body length (Dim A).  
 D The 20 pin end lead shoulder width is a vendor option, either half or full width.

4040049/E 12/2002

DGV (R-PDSO-G\*\*)

PLASTIC SMALL-OUTLINE

24 PINS SHOWN



4073251/E 08/00

- NOTES: A. All linear dimensions are in millimeters.  
 B. This drawing is subject to change without notice.  
 C. Body dimensions do not include mold flash or protrusion, not to exceed 0,15 per side.  
 D. Falls within JEDEC: 24/48 Pins – MO-153  
 14/16/20/56 Pins – MO-194

DW (R-PDSO-G\*\*)

PLASTIC SMALL-OUTLINE PACKAGE

16 PINS SHOWN

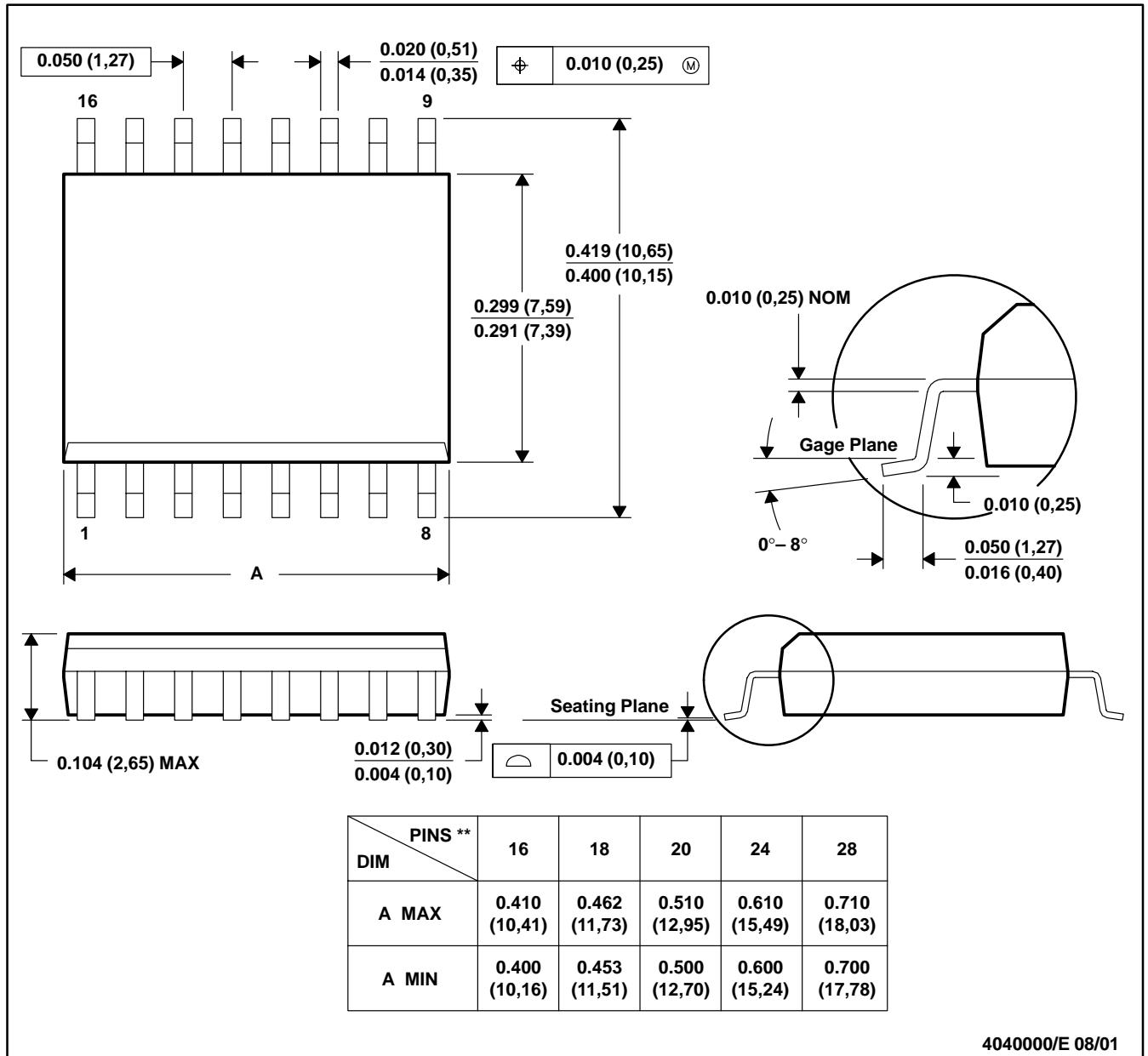

- NOTES: A. All linear dimensions are in inches (millimeters).  
 B. This drawing is subject to change without notice.  
 C. Body dimensions do not include mold flash or protrusion not to exceed 0.006 (0,15).  
 D. Falls within JEDEC MS-013

## MECHANICAL DATA

NS (R-PDSO-G\*\*)

PLASTIC SMALL-OUTLINE PACKAGE

14-PINS SHOWN



- NOTES:
- A. All linear dimensions are in millimeters.
  - B. This drawing is subject to change without notice.
  - C. Body dimensions do not include mold flash or protrusion, not to exceed 0,15.

DB (R-PDSO-G\*\*)

PLASTIC SMALL-OUTLINE

28 PINS SHOWN



- NOTES: A. All linear dimensions are in millimeters.  
 B. This drawing is subject to change without notice.  
 C. Body dimensions do not include mold flash or protrusion not to exceed 0,15.  
 D. Falls within JEDEC MO-150

PW (R-PDSO-G\*\*)

PLASTIC SMALL-OUTLINE PACKAGE

14 PINS SHOWN



4040064/F 01/97

- NOTES: A. All linear dimensions are in millimeters.  
 B. This drawing is subject to change without notice.  
 C. Body dimensions do not include mold flash or protrusion not to exceed 0,15.  
 D. Falls within JEDEC MO-153



## IMPORTANT NOTICE

Texas Instruments Incorporated and its subsidiaries (TI) reserve the right to make corrections, modifications, enhancements, improvements, and other changes to its products and services at any time and to discontinue any product or service without notice. Customers should obtain the latest relevant information before placing orders and should verify that such information is current and complete. All products are sold subject to TI's terms and conditions of sale supplied at the time of order acknowledgment.

TI warrants performance of its hardware products to the specifications applicable at the time of sale in accordance with TI's standard warranty. Testing and other quality control techniques are used to the extent TI deems necessary to support this warranty. Except where mandated by government requirements, testing of all parameters of each product is not necessarily performed.

TI assumes no liability for applications assistance or customer product design. Customers are responsible for their products and applications using TI components. To minimize the risks associated with customer products and applications, customers should provide adequate design and operating safeguards.

TI does not warrant or represent that any license, either express or implied, is granted under any TI patent right, copyright, mask work right, or other TI intellectual property right relating to any combination, machine, or process in which TI products or services are used. Information published by TI regarding third-party products or services does not constitute a license from TI to use such products or services or a warranty or endorsement thereof. Use of such information may require a license from a third party under the patents or other intellectual property of the third party, or a license from TI under the patents or other intellectual property of TI.

Reproduction of information in TI data books or data sheets is permissible only if reproduction is without alteration and is accompanied by all associated warranties, conditions, limitations, and notices. Reproduction of this information with alteration is an unfair and deceptive business practice. TI is not responsible or liable for such altered documentation.

Resale of TI products or services with statements different from or beyond the parameters stated by TI for that product or service voids all express and any implied warranties for the associated TI product or service and is an unfair and deceptive business practice. TI is not responsible or liable for any such statements.

Following are URLs where you can obtain information on other Texas Instruments products and application solutions:

<b>Products</b>		<b>Applications</b>	
Amplifiers	<a href="http://amplifier.ti.com">amplifier.ti.com</a>	Audio	<a href="http://www.ti.com/audio">www.ti.com/audio</a>
Data Converters	<a href="http://dataconverter.ti.com">dataconverter.ti.com</a>	Automotive	<a href="http://www.ti.com/automotive">www.ti.com/automotive</a>
DSP	<a href="http://dsp.ti.com">dsp.ti.com</a>	Broadband	<a href="http://www.ti.com/broadband">www.ti.com/broadband</a>
Interface	<a href="http://interface.ti.com">interface.ti.com</a>	Digital Control	<a href="http://www.ti.com/digitalcontrol">www.ti.com/digitalcontrol</a>
Logic	<a href="http://logic.ti.com">logic.ti.com</a>	Military	<a href="http://www.ti.com/military">www.ti.com/military</a>
Power Mgmt	<a href="http://power.ti.com">power.ti.com</a>	Optical Networking	<a href="http://www.ti.com/opticalnetwork">www.ti.com/opticalnetwork</a>
Microcontrollers	<a href="http://microcontroller.ti.com">microcontroller.ti.com</a>	Security	<a href="http://www.ti.com/security">www.ti.com/security</a>
		Telephony	<a href="http://www.ti.com/telephony">www.ti.com/telephony</a>
		Video & Imaging	<a href="http://www.ti.com/video">www.ti.com/video</a>
		Wireless	<a href="http://www.ti.com/wireless">www.ti.com/wireless</a>

Mailing Address: Texas Instruments  
Post Office Box 655303 Dallas, Texas 75265

Copyright © 2003, Texas Instruments Incorporated