

Multipoint RS485/RS422 Transceivers/Repeaters

Check for Samples: [DS3695](#), [DS3695T](#), [DS3696](#), [DS3697](#)

FEATURES

- Meets EIA standard RS485 for Multipoint Bus Transmission and is Compatible with RS-422
- 15 ns Driver Propagation Delays with 2 ns Skew (Typical)
- Single +5V supply
- -7V to +12V Bus Common Mode Range Permits $\pm 7V$ Ground Difference Between Devices on the Bus
- Thermal Shutdown Protection
- High Impedance to Bus with Driver in TRI-STATE or with Power Off, Over the Entire Common Mode Range Allows the Unused Devices on the Bus to be Powered Down
- Combined Impedance of a Driver Output and Receiver Input is Less than one RS485 Unit Load, Allowing up to 32 Transceivers on the Bus
- 70 mV Typical Receiver Hysteresis

DESCRIPTION

The DS3695, DS3696, and DS3697 are high speed differential TRI-STATE bus/line transceivers/repeaters designed to meet the requirements of EIA standard RS485 with extended common mode range (+12V to -7V), for multipoint data transmission.

The driver and receiver outputs feature TRI-STATE capability. The driver outputs remain in TRI-STATE over the entire common mode range of +12V to -7V. Bus faults that cause excessive power dissipation within the device trigger a thermal shutdown circuit, which forces the driver outputs into the high impedance state. The DS3696 provides an output pin TS (thermal shutdown) which reports the occurrence of the thermal shutdown of the device. This is an "open collector" pin with an internal 10 k Ω pull-up resistor. This allows the line fault outputs of several devices to be wire OR-ed.

Both AC and DC specifications are specified over the 0°C to 70°C temperature and 4.75V to 5.25V supply voltage range.

Connection and Logic Diagrams

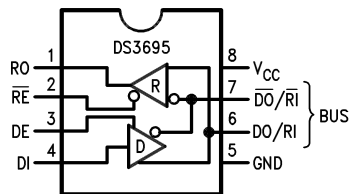

Figure 1. PDIP (Top View)
See Package Number P (R-PDIP-T8)

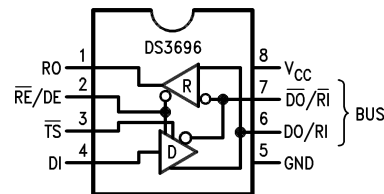

Figure 2. PDIP (Top View)
See Package Number P (R-PDIP-T8)

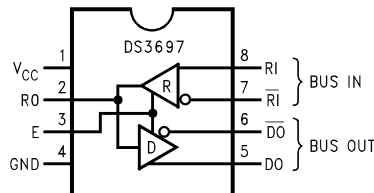

Figure 3. PDIP (Top View)
See Package Number P (R-PDIP-T8)

\overline{TS} pin was \overline{LF} (Line Fault) in previous data sheets and reports the occurrence of a thermal shutdown of the device.



Please be aware that an important notice concerning availability, standard warranty, and use in critical applications of Texas Instruments semiconductor products and disclaimers thereto appears at the end of this data sheet.

All trademarks are the property of their respective owners.



These devices have limited built-in ESD protection. The leads should be shorted together or the device placed in conductive foam during storage or handling to prevent electrostatic damage to the MOS gates.

Absolute Maximum Ratings ⁽¹⁾⁽²⁾

	VALUE	UNIT
Supply Voltage, V_{CC}	7	V
Control Input Voltages	7	V
Driver Input Voltage	7	V
Driver Output Voltages	+15/-10	V
Receiver Input Voltages (DS3695, DS3696)	+15/-10	V
Receiver Common Mode Voltage (DS3697)	± 25	V
Receiver Output Voltage	5.5	V
Continuous Power Dissipation @ 25°C - N Package ⁽³⁾	1.07	W
Storage Temperature Range	-65 to +150	°C
Lead Temperature (Soldering, 4 sec.)	260	°C

- (1) "Absolute Maximum Ratings" are those beyond which the safety of the device cannot be verified. They are not meant to imply that the device should be operated at these limits. The tables of "Electrical Characteristics" provide conditions for actual device operation.
- (2) If Military/Aerospace specified devices are required, please contact the TI Sales Office/ Distributors for availability and specifications.
- (3) All typicals are given for $V_{CC} = 5V$ and $T_A = 25^\circ C$.

Recommended Operating Conditions

		Min	Max	Units
Supply Voltage, V_{CC}		4.75	5.25	V
Bus Voltage		-7	+12	V
Operating Free Air Temp. (T_A)	Commercial	0	+70	°C
	Industrial	-40	+85	°C

Electrical Characteristics ⁽¹⁾⁽²⁾

0°C ≤ T_A ≤ +70°C, 4.75V < V_{CC} < 5.25V unless otherwise specified

Symbol	Parameter	Conditions	Min	Typ	Max	Units	
V_{OD1}	Differential Driver Output Voltage (Unloaded)	$I_O = 0$			5	V	
V_{OD2}	Differential Driver Output Voltage (with Load)	See Figure 4	R = 50Ω; (RS-422) ⁽³⁾			V	
				R = 27Ω; (RS-485)	1.5		V
ΔV_{OD}	Change in Magnitude of Driver Differential Output Voltage for Complementary Output States	See Figure 4	R = 27Ω		0.2	V	
V_{OC}	Driver Common Mode Output Voltage				3.0	V	
$\Delta V_{OC} $	Change in Magnitude of Driver Common Mode Output Voltage for Complementary Output States				0.2	V	
V_{IH}	Input High Voltage	DI, DE, \overline{RE} , E, \overline{RE}/DE	2			V	
V_{IL}	Input Low Voltage				0.8	V	
V_{CL}	Input Clamp Voltage				-1.5	V	
I_{IL}	Input Low Current				-200	μA	
I_{IH}	Input High Current				20	μA	
I_{IN}	Input Current	DO/RI, $\overline{DO}/\overline{RI}$ RI, \overline{RI}	$V_{CC} = 0V$ or 5.25V \overline{RE}/DE or $DE = 0V$	$V_{IN} = 12V$		+1.0	mA
				$V_{IN} = -7V$		-0.8	mA

- (1) All currents into device pins are positive; all currents out of device pins are negative. All voltages are referenced to device ground unless otherwise specified.
- (2) All typicals are given for $V_{CC} = 5V$ and $T_A = 25^\circ C$.
- (3) All limits for which derate linearly at 11.1 mW/°C to 570 mW at 70°C is applied must be derated by 10% for DS3695T and DS3696T. Other parameters remain the same for this extended temperature range device (-40°C ≤ T_A ≤ +85°C).

Electrical Characteristics ⁽¹⁾⁽²⁾ (continued)
 $0^{\circ}\text{C} \leq T_A \leq +70^{\circ}\text{C}$, $4.75\text{V} < V_{CC} < 5.25\text{V}$ unless otherwise specified

Symbol	Parameter	Conditions	Min	Typ	Max	Units	
I_{OZD}	TRI-STATE Current DS3697 & DS3698	DO, \overline{DO} $V_{CC} = 0\text{V}$ or 5.25V , $E = 0\text{V}$ $-7\text{V} < V_O < +12\text{V}$			± 100	μA	
V_{TH}	Differential Input Threshold Voltage for Receiver	$-7\text{V} \leq V_{CM} \leq +12\text{V}$	-0.2		+0.2	V	
ΔV_{TH}	Receiver Input Hysteresis	$V_{CM} = 0\text{V}$		70		mV	
V_{OH}	Receiver Output High Voltage	$I_{OH} = -400\ \mu\text{A}$	2.4			V	
V_{OL}	Output Low Voltage	RO			0.5	V	
		\overline{TS}			0.45	V	
I_{OZR}	OFF-State (High Impedance) Output Current at Receiver	$V_{CC} = \text{Max}$ $0.4\text{V} \leq V_O \leq 2.4\text{V}$			± 20	μA	
R_{IN}	Receiver Input Resistance	$-7\text{V} \leq V_{CM} \leq +12\text{V}$	12			k Ω	
I_{CC}	Supply Current	No Load ⁽³⁾	Driver Outputs Enabled		42	60	mA
			Driver Outputs Disabled		27	40	mA
I_{OSD}	Driver Short-Circuit Output Current	$V_O = -7\text{V}$ ⁽³⁾			-250	mA	
		$V_O = +12\text{V}$ ⁽³⁾			+250	mA	
I_{OSR}	Receiver Short-Circuit Output Current	$V_O = 0\text{V}$	-15		-85	mA	

Receiver Switching Characteristics ⁽¹⁾⁽²⁾
 $0^{\circ}\text{C} \leq T_A \leq +70^{\circ}\text{C}$, $4.75\text{V} < V_{CC} < 5.25\text{V}$ unless otherwise specified (Figure 5, Figure 6, Figure 7)

Symbol	Conditions	Min	Typ	Max	Units
t_{PLH}	$C_L = 15\ \text{pF}$	15	25	37	ns
t_{PHL}	S1 and S2	15	25	37	ns
$ t_{PLH} - t_{PHL} $	Closed	0			ns
t_{PLZ}	$C_L = 15\ \text{pF}$, S2 Open	5	12	16	ns
t_{PHZ}	$C_L = 15\ \text{pF}$, S1 Open	5	12	16	ns
t_{PZL}	$C_L = 15\ \text{pF}$, S2 Open	7	15	20	ns
t_{PZH}	$C_L = 15\ \text{pF}$, S1 Open	7	15	20	ns

 (1) All typicals are given for $V_{CC} = 5\text{V}$ and $T_A = 25^{\circ}\text{C}$.

(2) Switching Characteristics apply for DS3695, DS3695T, DS3696, DS3697 only.

Driver Switching Characteristics
 $0^{\circ}\text{C} \leq T_A \leq +70^{\circ}\text{C}$, $4.75\text{V} < V_{CC} < 5.25\text{V}$ unless otherwise specified

Symbol	Conditions	Min	Typ	Max	Units
SINGLE ENDED CHARACTERISTICS (Figure 8, Figure 9, Figure 10)					
t_{PLH}	$R_{L\text{DIFF}} = 60\ \Omega$	9	15	22	ns
t_{PHL}	$C_{L1} = C_{L2} = 100\ \text{pF}$	9	15	22	ns
$t_{SKEW} t_{PLH} - t_{PHL} $			2	8	ns
t_{PLZ}	$C_L = 15\ \text{pF}$, S2 Open	7	15	30	ns
t_{PHZ}	$C_L = 15\ \text{pF}$, S1 Open	7	15	30	ns
t_{PZL}	$C_L = 100\ \text{pF}$, S2 Open	30	35	50	ns
t_{PZH}	$C_L = 100\ \text{pF}$, S1 Open	30	35	50	ns
DIFFERENTIAL CHARACTERISTICS (Figure 8 Figure 11)					
t_r, t_f	$R_{L\text{DIFF}} = 60\ \Omega$ $C_{L1} = C_{L2} = 100\ \text{pF}$	6	10	18	ns

AC Test Circuits and Switching Waveforms

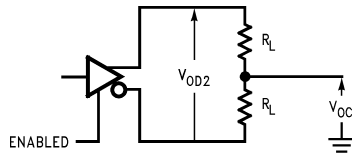

Figure 4. Driver V_{OD} and V_{OC}

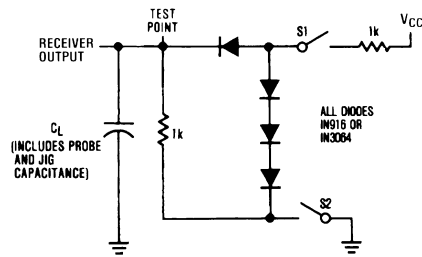
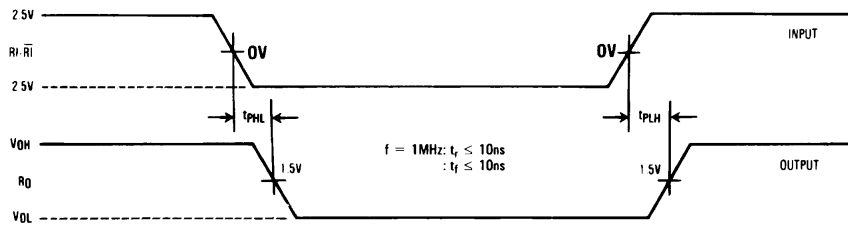

Figure 5. Receiver Propagation Delay Test Circuit



Note: Differential input voltage may be realized by grounding \overline{RI} and pulsing RI between +2.5V and -2.5V.

Figure 6. Receiver Input-to-Output Propagation Delay Timing

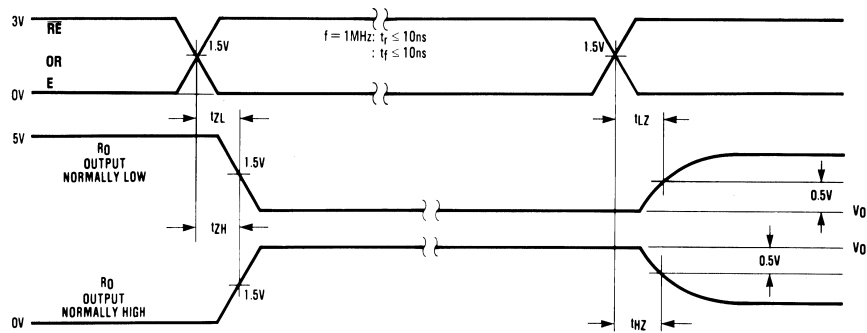
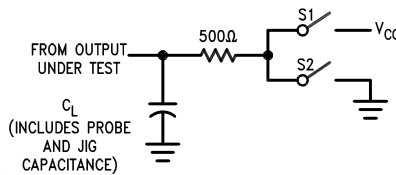

Figure 7. Receiver Enable/Disable Propagation Delay Timing



Note: Unless otherwise specified the switches are closed.

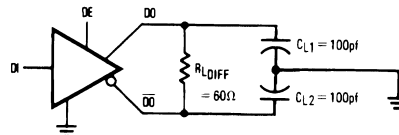
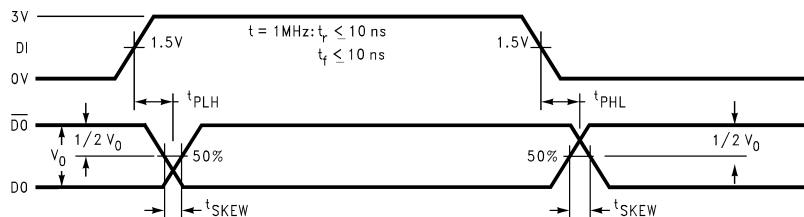

Figure 8. Driver Propagation Delay and Transition Time Test Circuits



Note: t_{PLH} and t_{PHL} are measured to the respective 50% points. t_{SKEW} is the difference between propagation delays of the complementary outputs.

Figure 9. Driver Input-to-Output Propagation Delay Timing (Single-Ended)

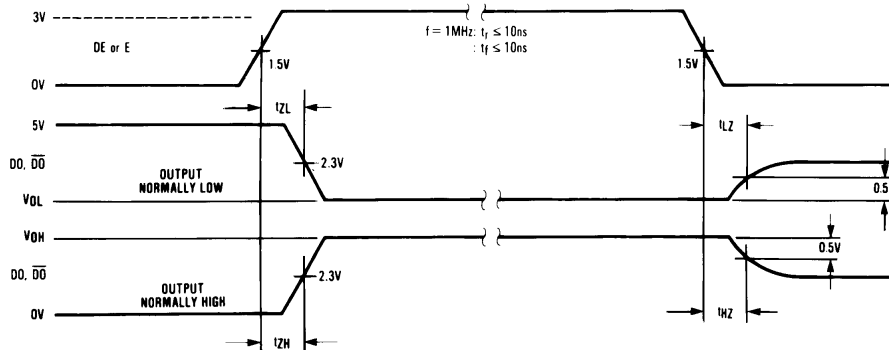

Figure 10. Driver Enable/Disable Propagation Delay Timing

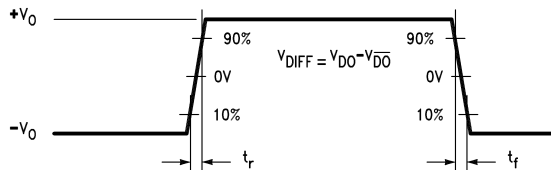

Figure 11. Driver Differential Transition Timing

Function Tables

Table 1. DS3695/DS3696 Transmitting⁽¹⁾

Inputs			Thermal Shutdown	Outputs		
\overline{RE}	DE	DI		\overline{DO}	DO	\overline{TS}^* (DS3696 Only)
X	1	1	OFF	0	1	H
X	1	0	OFF	1	0	H
X	0	X	OFF	Z	Z	H
X	1	X	ON	Z	Z	L

- (1) X—Don't care condition
 Z—High impedance state
 * \overline{TS} is an "open collector" output with an on-chip 10 k Ω pull-up resistor that reports the occurrence of a thermal shutdown of the device.

Table 2. DS3695/DS3696 Receiving⁽¹⁾

Inputs			Outputs	
\overline{RE}	DE	RI- \overline{RI}	RO	\overline{TS}^* (DS3696 Only)
0	0	$\geq +0.2V$	1	H
0	0	$\leq -0.2V$	0	H
1	0	X	Z	H

- (1) X—Don't care condition
 Z—High impedance state
 * \overline{TS} is an "open collector" output with an on-chip 10 k Ω pull-up resistor that reports the occurrence of a thermal shutdown of the device.

Table 3. DS3697⁽¹⁾

Inputs		Thermal Shutdown	Outputs		
E	RI- \overline{RI}		\overline{DO}	DO	RO (DS3697 Only)
1	$\geq +0.2V$	OFF	0	1	1
1	$\leq -0.2V$	OFF	1	0	0
0	X	OFF	Z	Z	Z
1	$\geq +0.2V$	ON	Z	Z	1
1	$\leq -0.2V$	ON	Z	Z	0

- (1) X—Don't care condition
 Z—High impedance state
 * \overline{TS} is an "open collector" output with an on-chip 10 k Ω pull-up resistor that reports the occurrence of a thermal shutdown of the device.

Typical Application

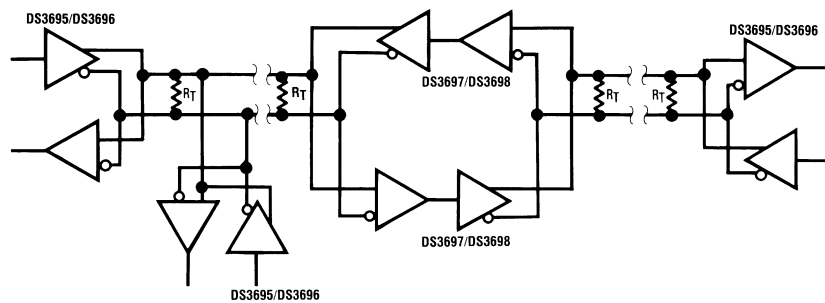

Note: Repeater control logic not shown

Typical Performance Characteristics

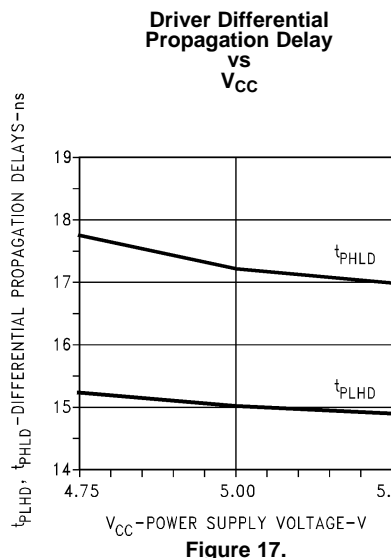
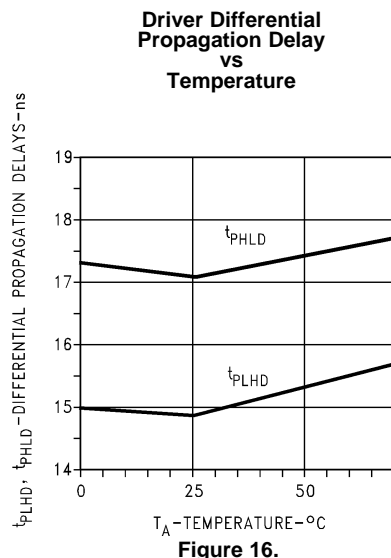
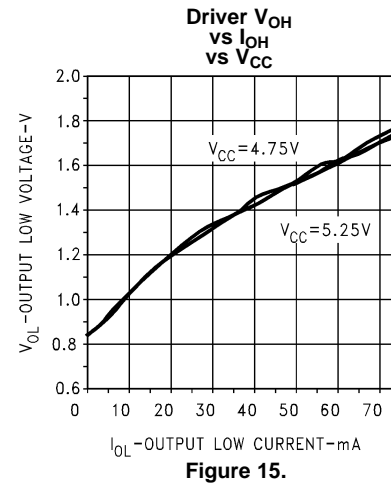
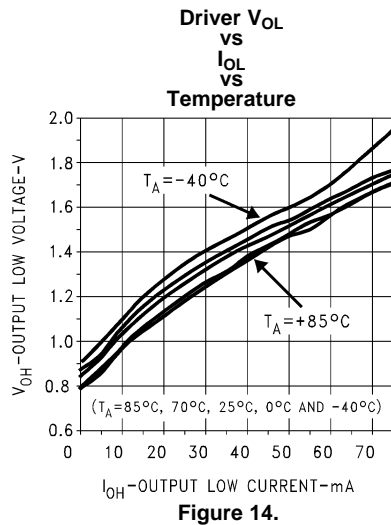
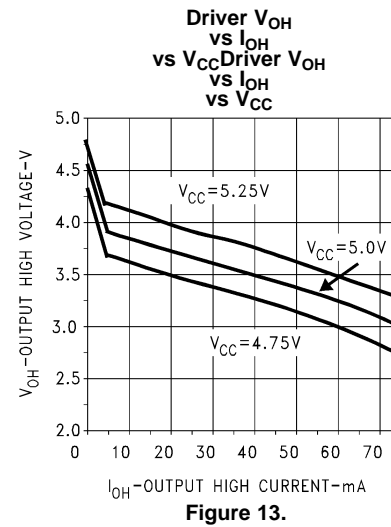
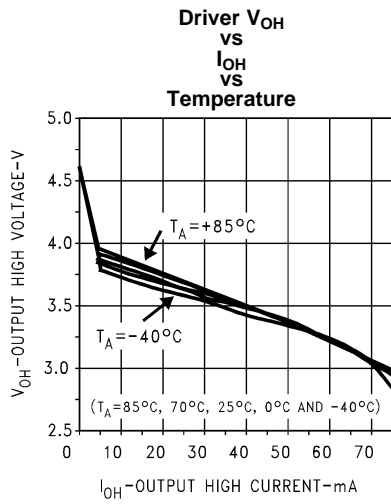

Typical Performance Characteristics (continued)

Driver Single-Ended Propagation Delay vs Temperature

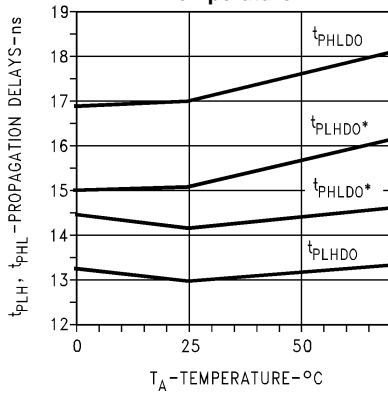

Figure 18.

Driver Single-Ended Propagation Delay vs VCC

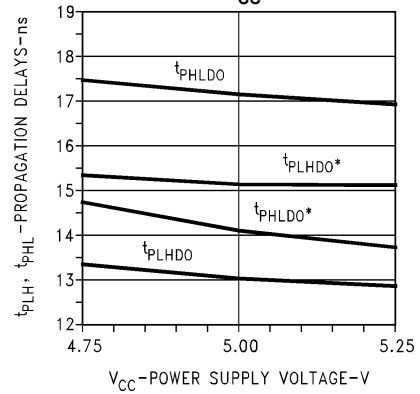

Figure 19.

Driver Transition Time vs Temperature

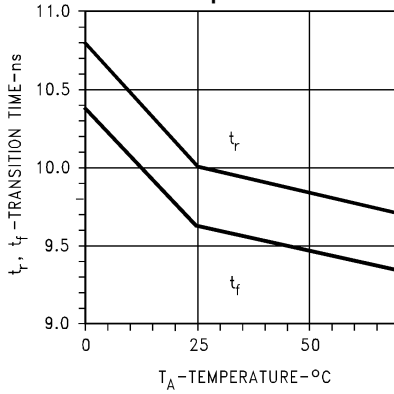

Figure 20.

Driver Transition Time vs VCC

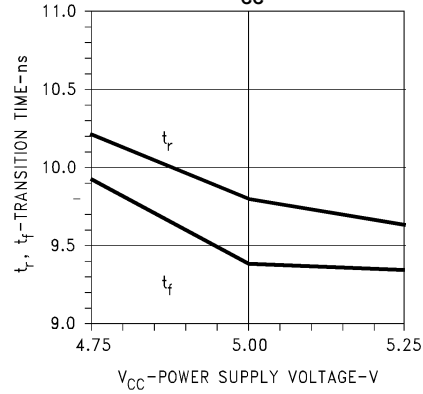

Figure 21.

Cable Length vs Data Rate

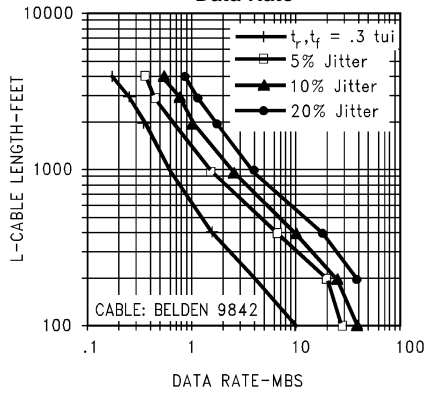

Figure 22.

Supply Current vs Temperature

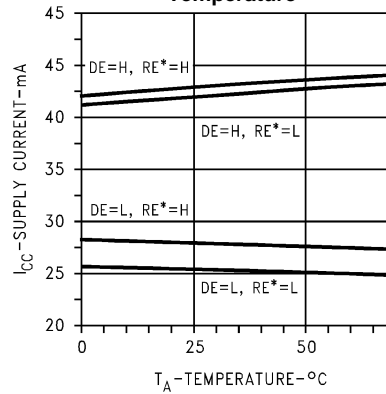

Figure 23.

Typical Performance Characteristics (continued)

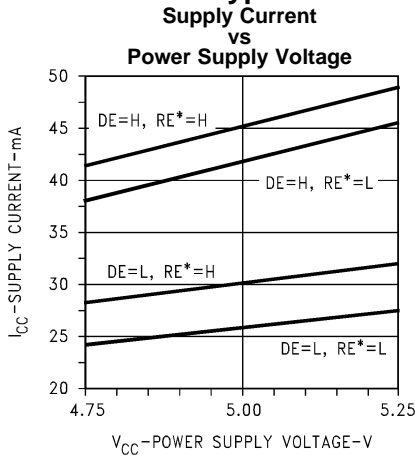

Figure 24.

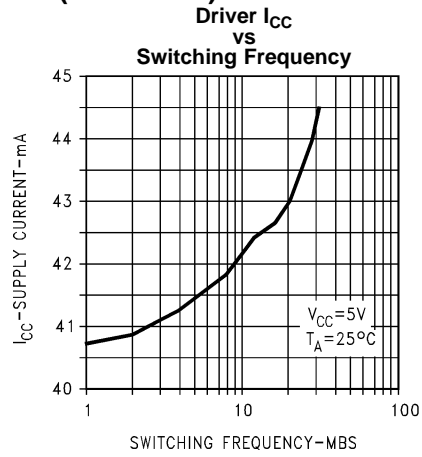

Figure 25.

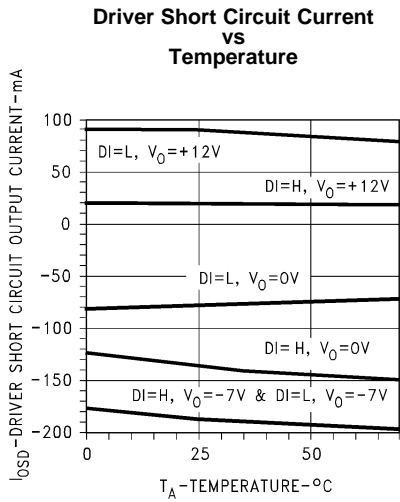

Figure 26.

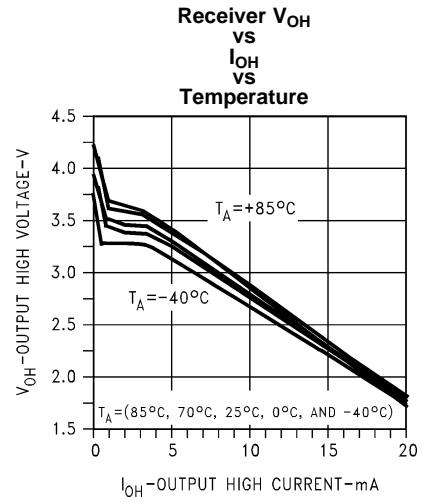

Figure 27.

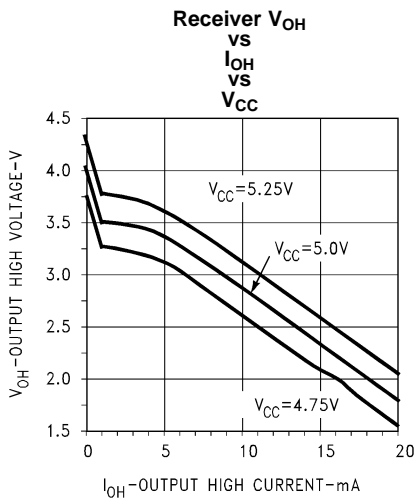

Figure 28.

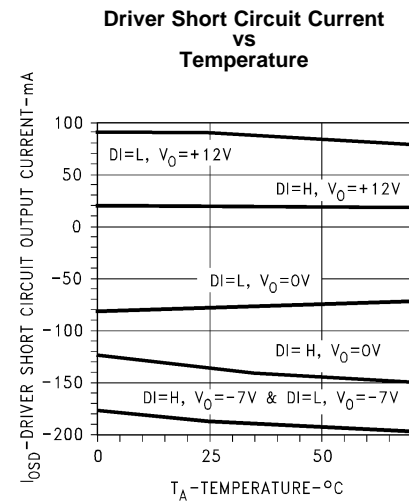
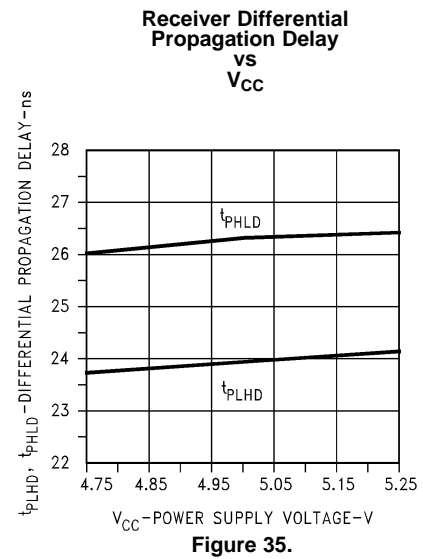
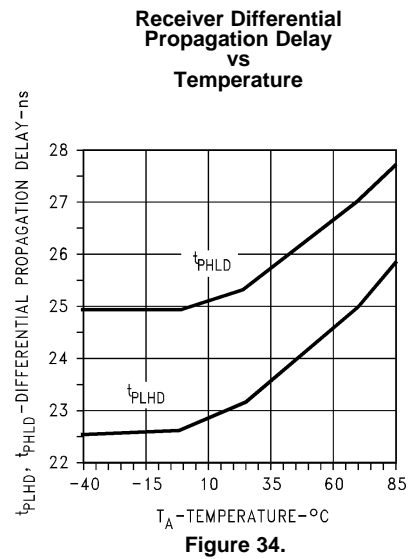
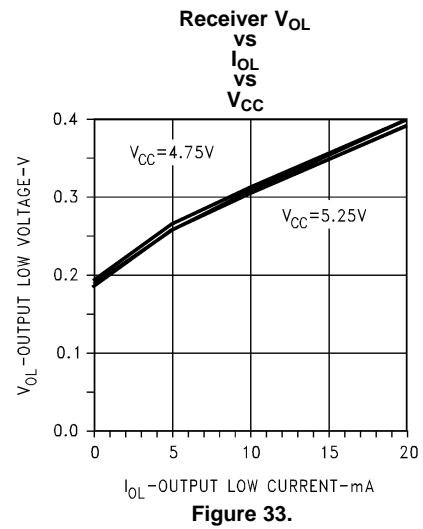
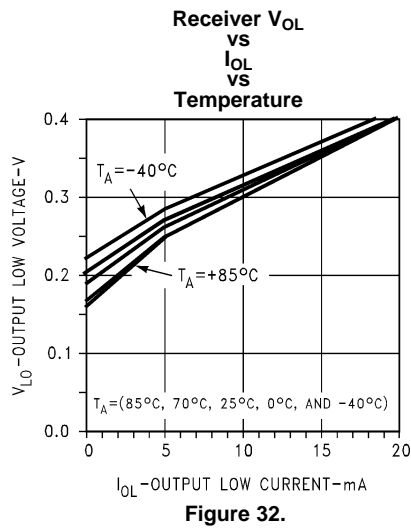
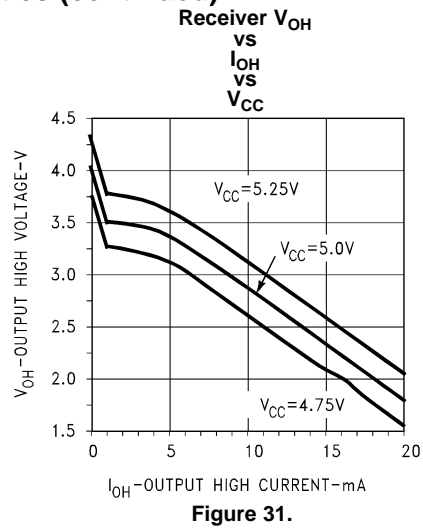
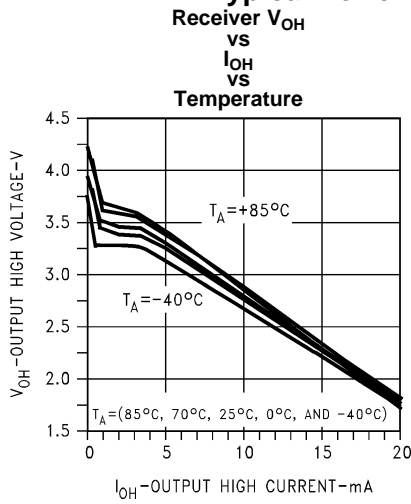

Figure 29.

Typical Performance Characteristics (continued)



Typical Performance Characteristics (continued)

Receiver Short Circuit Current vs Temperature

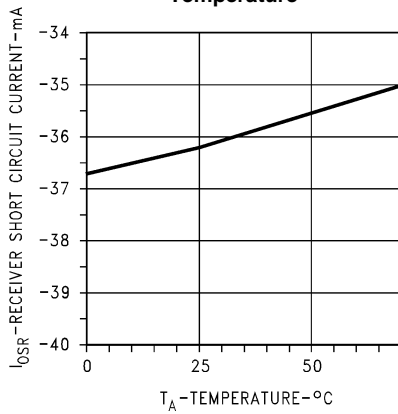

Figure 36.

Receiver Short Circuit Current vs Power Supply

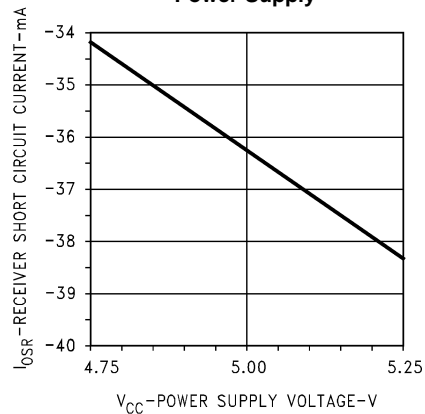

Figure 37.

Receiver Non-Inverting Input Current vs Temperature

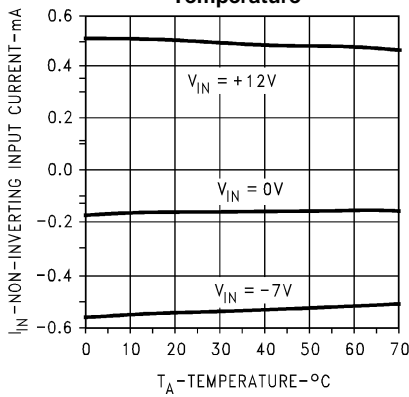

Figure 38.

Receiver Non-Inverting Input Current vs Power Supply Voltage

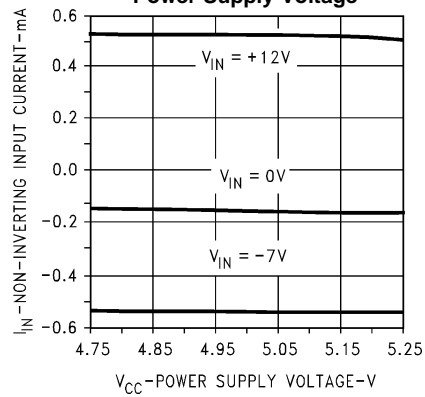

Figure 39.

Receiver Inverting Input Current vs Temperature

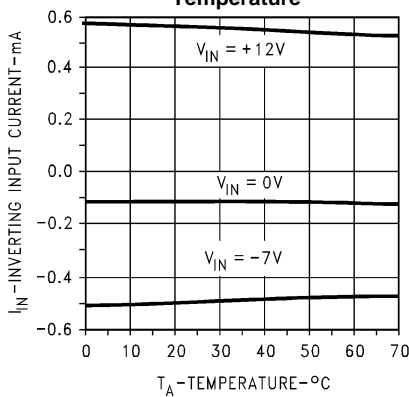

Figure 40.

Receiver Inverting Input Current vs Power Supply Voltage

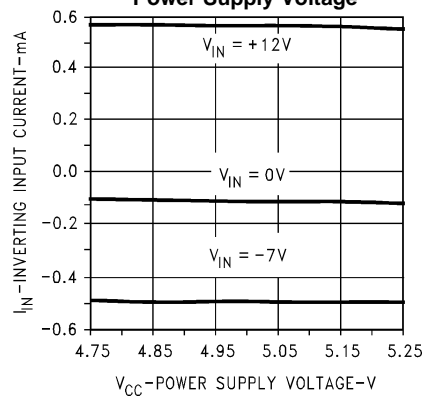
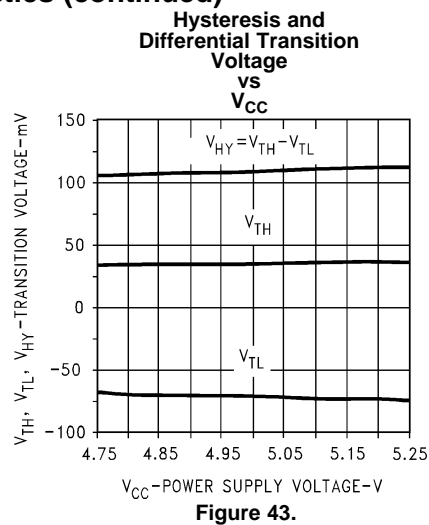
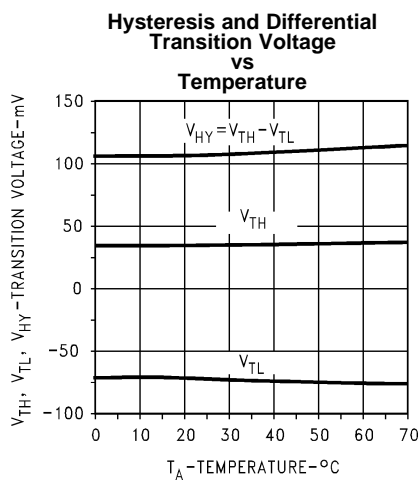

Figure 41.

Typical Performance Characteristics (continued)



REVISION HISTORY

Changes from Revision B (April 2013) to Revision C	Page
• Changed layout of National Data Sheet to TI format	11

PACKAGING INFORMATION

Orderable Device	Status (1)	Package Type	Package Drawing	Pins	Package Qty	Eco Plan (2)	Lead/Ball Finish (6)	MSL Peak Temp (3)	Op Temp (°C)	Device Marking (4/5)	Samples
DS3695N/NOPB	LIFEBUY	PDIP	P	8	40	Green (RoHS & no Sb/Br)	CU SN	Level-1-NA-UNLIM	0 to 70	DS3695N	
DS3695TN/NOPB	LIFEBUY	PDIP	P	8	40	Green (RoHS & no Sb/Br)	CU SN	Level-1-NA-UNLIM	-40 to 85	DS 3695TN	

(1) The marketing status values are defined as follows:

ACTIVE: Product device recommended for new designs.

LIFEBUY: TI has announced that the device will be discontinued, and a lifetime-buy period is in effect.

NRND: Not recommended for new designs. Device is in production to support existing customers, but TI does not recommend using this part in a new design.

PREVIEW: Device has been announced but is not in production. Samples may or may not be available.

OBsolete: TI has discontinued the production of the device.

(2) **RoHS:** TI defines "RoHS" to mean semiconductor products that are compliant with the current EU RoHS requirements for all 10 RoHS substances, including the requirement that RoHS substance do not exceed 0.1% by weight in homogeneous materials. Where designed to be soldered at high temperatures, "RoHS" products are suitable for use in specified lead-free processes. TI may reference these types of products as "Pb-Free".

RoHS Exempt: TI defines "RoHS Exempt" to mean products that contain lead but are compliant with EU RoHS pursuant to a specific EU RoHS exemption.

Green: TI defines "Green" to mean the content of Chlorine (Cl) and Bromine (Br) based flame retardants meet JS709B low halogen requirements of <=1000ppm threshold. Antimony trioxide based flame retardants must also meet the <=1000ppm threshold requirement.

(3) MSL, Peak Temp. - The Moisture Sensitivity Level rating according to the JEDEC industry standard classifications, and peak solder temperature.

(4) There may be additional marking, which relates to the logo, the lot trace code information, or the environmental category on the device.

(5) Multiple Device Markings will be inside parentheses. Only one Device Marking contained in parentheses and separated by a "~" will appear on a device. If a line is indented then it is a continuation of the previous line and the two combined represent the entire Device Marking for that device.

(6) Lead/Ball Finish - Orderable Devices may have multiple material finish options. Finish options are separated by a vertical ruled line. Lead/Ball Finish values may wrap to two lines if the finish value exceeds the maximum column width.

Important Information and Disclaimer:The information provided on this page represents TI's knowledge and belief as of the date that it is provided. TI bases its knowledge and belief on information provided by third parties, and makes no representation or warranty as to the accuracy of such information. Efforts are underway to better integrate information from third parties. TI has taken and continues to take reasonable steps to provide representative and accurate information but may not have conducted destructive testing or chemical analysis on incoming materials and chemicals. TI and TI suppliers consider certain information to be proprietary, and thus CAS numbers and other limited information may not be available for release.

In no event shall TI's liability arising out of such information exceed the total purchase price of the TI part(s) at issue in this document sold by TI to Customer on an annual basis.

P (R-PDIP-T8)

PLASTIC DUAL-IN-LINE PACKAGE



4040082/E 04/2010

- NOTES:
- A. All linear dimensions are in inches (millimeters).
 - B. This drawing is subject to change without notice.
 - C. Falls within JEDEC MS-001 variation BA.

IMPORTANT NOTICE

Texas Instruments Incorporated (TI) reserves the right to make corrections, enhancements, improvements and other changes to its semiconductor products and services per JESD46, latest issue, and to discontinue any product or service per JESD48, latest issue. Buyers should obtain the latest relevant information before placing orders and should verify that such information is current and complete.

TI's published terms of sale for semiconductor products (<http://www.ti.com/sc/docs/stdterms.htm>) apply to the sale of packaged integrated circuit products that TI has qualified and released to market. Additional terms may apply to the use or sale of other types of TI products and services.

Reproduction of significant portions of TI information in TI data sheets is permissible only if reproduction is without alteration and is accompanied by all associated warranties, conditions, limitations, and notices. TI is not responsible or liable for such reproduced documentation. Information of third parties may be subject to additional restrictions. Resale of TI products or services with statements different from or beyond the parameters stated by TI for that product or service voids all express and any implied warranties for the associated TI product or service and is an unfair and deceptive business practice. TI is not responsible or liable for any such statements.

Buyers and others who are developing systems that incorporate TI products (collectively, "Designers") understand and agree that Designers remain responsible for using their independent analysis, evaluation and judgment in designing their applications and that Designers have full and exclusive responsibility to assure the safety of Designers' applications and compliance of their applications (and of all TI products used in or for Designers' applications) with all applicable regulations, laws and other applicable requirements. Designer represents that, with respect to their applications, Designer has all the necessary expertise to create and implement safeguards that (1) anticipate dangerous consequences of failures, (2) monitor failures and their consequences, and (3) lessen the likelihood of failures that might cause harm and take appropriate actions. Designer agrees that prior to using or distributing any applications that include TI products, Designer will thoroughly test such applications and the functionality of such TI products as used in such applications.

TI's provision of technical, application or other design advice, quality characterization, reliability data or other services or information, including, but not limited to, reference designs and materials relating to evaluation modules, (collectively, "TI Resources") are intended to assist designers who are developing applications that incorporate TI products; by downloading, accessing or using TI Resources in any way, Designer (individually or, if Designer is acting on behalf of a company, Designer's company) agrees to use any particular TI Resource solely for this purpose and subject to the terms of this Notice.

TI's provision of TI Resources does not expand or otherwise alter TI's applicable published warranties or warranty disclaimers for TI products, and no additional obligations or liabilities arise from TI providing such TI Resources. TI reserves the right to make corrections, enhancements, improvements and other changes to its TI Resources. TI has not conducted any testing other than that specifically described in the published documentation for a particular TI Resource.

Designer is authorized to use, copy and modify any individual TI Resource only in connection with the development of applications that include the TI product(s) identified in such TI Resource. NO OTHER LICENSE, EXPRESS OR IMPLIED, BY ESTOPPEL OR OTHERWISE TO ANY OTHER TI INTELLECTUAL PROPERTY RIGHT, AND NO LICENSE TO ANY TECHNOLOGY OR INTELLECTUAL PROPERTY RIGHT OF TI OR ANY THIRD PARTY IS GRANTED HEREIN, including but not limited to any patent right, copyright, mask work right, or other intellectual property right relating to any combination, machine, or process in which TI products or services are used. Information regarding or referencing third-party products or services does not constitute a license to use such products or services, or a warranty or endorsement thereof. Use of TI Resources may require a license from a third party under the patents or other intellectual property of the third party, or a license from TI under the patents or other intellectual property of TI.

TI RESOURCES ARE PROVIDED "AS IS" AND WITH ALL FAULTS. TI DISCLAIMS ALL OTHER WARRANTIES OR REPRESENTATIONS, EXPRESS OR IMPLIED, REGARDING RESOURCES OR USE THEREOF, INCLUDING BUT NOT LIMITED TO ACCURACY OR COMPLETENESS, TITLE, ANY EPIDEMIC FAILURE WARRANTY AND ANY IMPLIED WARRANTIES OF MERCHANTABILITY, FITNESS FOR A PARTICULAR PURPOSE, AND NON-INFRINGEMENT OF ANY THIRD PARTY INTELLECTUAL PROPERTY RIGHTS. TI SHALL NOT BE LIABLE FOR AND SHALL NOT DEFEND OR INDEMNIFY DESIGNER AGAINST ANY CLAIM, INCLUDING BUT NOT LIMITED TO ANY INFRINGEMENT CLAIM THAT RELATES TO OR IS BASED ON ANY COMBINATION OF PRODUCTS EVEN IF DESCRIBED IN TI RESOURCES OR OTHERWISE. IN NO EVENT SHALL TI BE LIABLE FOR ANY ACTUAL, DIRECT, SPECIAL, COLLATERAL, INDIRECT, PUNITIVE, INCIDENTAL, CONSEQUENTIAL OR EXEMPLARY DAMAGES IN CONNECTION WITH OR ARISING OUT OF TI RESOURCES OR USE THEREOF, AND REGARDLESS OF WHETHER TI HAS BEEN ADVISED OF THE POSSIBILITY OF SUCH DAMAGES.

Unless TI has explicitly designated an individual product as meeting the requirements of a particular industry standard (e.g., ISO/TS 16949 and ISO 26262), TI is not responsible for any failure to meet such industry standard requirements.

Where TI specifically promotes products as facilitating functional safety or as compliant with industry functional safety standards, such products are intended to help enable customers to design and create their own applications that meet applicable functional safety standards and requirements. Using products in an application does not by itself establish any safety features in the application. Designers must ensure compliance with safety-related requirements and standards applicable to their applications. Designer may not use any TI products in life-critical medical equipment unless authorized officers of the parties have executed a special contract specifically governing such use. Life-critical medical equipment is medical equipment where failure of such equipment would cause serious bodily injury or death (e.g., life support, pacemakers, defibrillators, heart pumps, neurostimulators, and implantables). Such equipment includes, without limitation, all medical devices identified by the U.S. Food and Drug Administration as Class III devices and equivalent classifications outside the U.S.

TI may expressly designate certain products as completing a particular qualification (e.g., Q100, Military Grade, or Enhanced Product). Designers agree that it has the necessary expertise to select the product with the appropriate qualification designation for their applications and that proper product selection is at Designers' own risk. Designers are solely responsible for compliance with all legal and regulatory requirements in connection with such selection.

Designer will fully indemnify TI and its representatives against any damages, costs, losses, and/or liabilities arising out of Designer's non-compliance with the terms and provisions of this Notice.