

TOSHIBA BI-DIRECTIONAL TRIODE THYRISTOR SILICON PLANAR TYPE

# SM3GZ47, SM3JZ47

## AC POWER CONTROL APPLICATIONS

- Repetitive Peak Off-State Voltage:  $V_{DRM} = 400V, 600V$
- R.M.S On-State Current:  $I_T (RMS) = 3A$
- High Commutating ( $dv / dt$ )
- Isolation Voltage:  $V_{ISOL} = 1500V AC$

## ABSOLUTE MAXIMUM RATINGS

CHARACTERISTIC	SYMBOL	RATING	UNIT
Repetitive Peak Off-State Voltage	SM3GZ47	400	V
	SM3JZ47	600	
R.M.S On-State Current (Full Sine Waveform $T_c = 110^\circ C$ )	$I_T (RMS)$	3	A
Peak One Cycle Surge On-State Current (Non-Repetitive)	$I_{TSM}$	30 (50Hz)	A
		33 (60Hz)	
$I^2t$ Limit Value ( $t = 1\sim 10ms$ )	$I^2t$	4.5	$A^2s$
Critical Rate of Rise of On-State Current (Note 1)	$di / dt$	50	$A / \mu s$
Peak Gate Power Dissipation	$P_{GM}$	5	W
Average Gate Power Dissipation	$P_{G(AV)}$	0.5	W
Peak Gate Voltage	$V_{GM}$	10	V
Peak Gate Current	$I_{GM}$	2	A
Junction Temperature	$T_j$	-40~125	$^\circ C$
Storage Temperature Range	$T_{stg}$	-40~125	$^\circ C$
Isolation Voltage (AC, $t = 1min.$ )	$V_{ISOL}$	1500	V

Note 1:  $di / dt$  test condition

$$V_{DRM} = 0.5 \times \text{Rated}$$

$$I_{TM} \leq 4.5A$$

$$t_{gw} \geq 10\mu s$$

$$t_{gr} \leq 250ns$$

$$i_{gp} = I_{GT} \times 2.0$$

Note: Using continuously under heavy loads (e.g. the application of high temperature/current/voltage and the significant change in temperature, etc.) may cause this product to decrease in the reliability significantly even if the operating conditions (i.e. operating temperature/current/voltage, etc.) are within the absolute maximum ratings.

Please design the appropriate reliability upon reviewing the Toshiba Semiconductor Reliability Handbook ("Handling Precautions"/Derating Concept and Methods) and individual reliability data (i.e. reliability test report and estimated failure rate, etc).

Unit: mm

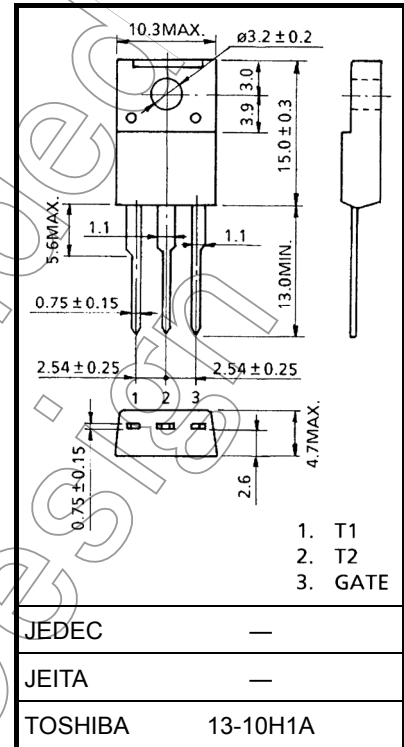

Weight: 1.7 g (typ.)

## ELECTRICAL CHARACTERISTICS (Ta = 25°C)

CHARACTERISTIC		SYMBOL	TEST CONDITION	MIN	TYP.	MAX	UNIT	
Repetitive Peak Off-State Current		$I_{DRM}$	$V_{DRM} = \text{Rated}$	—	—	20	$\mu\text{A}$	
Gate Trigger Voltage	I	$V_{GT}$	$V_D = 12\text{V}$ $R_L = 20\Omega$	T2 (+), Gate (+)	—	—	1.5	V
	II			T2 (+), Gate (-)	—	—	1.5	
	III			T2 (-), Gate (-)	—	—	1.5	
	IV			T2 (-), Gate (+)	—	—	—	
Gate Trigger Current	I	$I_{GT}$	$V_D = 12\text{V}$ $R_L = 20\Omega$	T2 (+), Gate (+)	—	—	20	mA
	II			T2 (+), Gate (-)	—	—	20	
	III			T2 (-), Gate (-)	—	—	20	
	IV			T2 (-), Gate (+)	—	—	—	
Peak On-State Voltage		$V_{TM}$	$I_{TM} = 4.5\text{A}$	—	—	1.5	V	
Gate Non-Trigger Voltage		$V_{GD}$	$V_D = \text{Rated}, T_c = 125^\circ\text{C}$	0.2	—	—	V	
Holding Current		$I_H$	$V_D = 12\text{V}, I_{TM} = 1\text{A}$	—	—	30	mA	
Thermal Resistance		$R_{th(j-c)}$	Junction to Case, AC	—	—	4.2	$^\circ\text{C} / \text{W}$	
Critical Rate of Rise of Off-State Voltage		$dv / dt$	$V_{DRM} = \text{Rated}, T_j = 125^\circ\text{C}$ Exponential Rise	—	300	—	$\text{V} / \mu\text{s}$	
Critical Rate of Rise of Off-State Voltage at Commutation		$(dv / dt)_c$	$V_{DRM} = 400\text{V}, T_j = 125^\circ\text{C}$ $(di / dt)_c = -2.0\text{A} / \text{ms}$	10	—	—	$\text{V} / \mu\text{s}$	

## MARKING

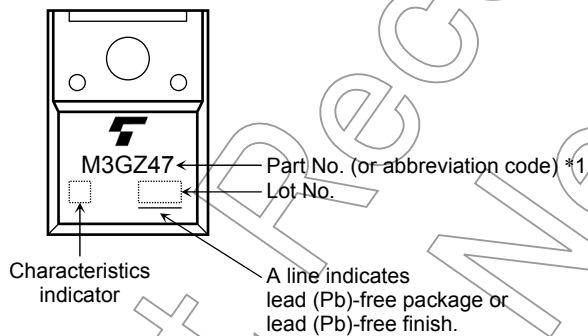

*1	Part No. (or abbreviation code)	Part No.
	M3GZ47	SM3GZ47
	M3JZ47	SM3JZ47

GATE TRIGGER CHARACTERISTIC

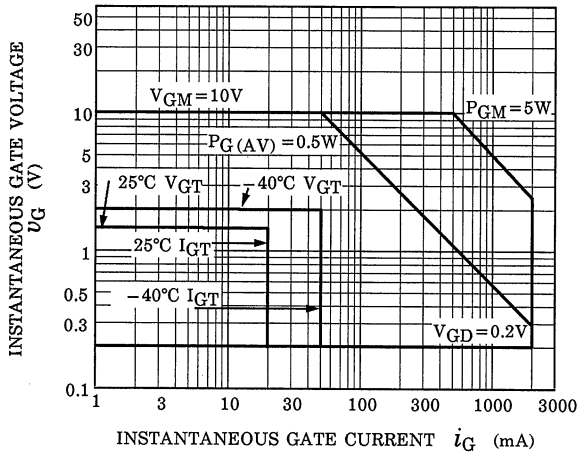

SURGE ON-STATE CURRENT (NON-REPETITIVE)

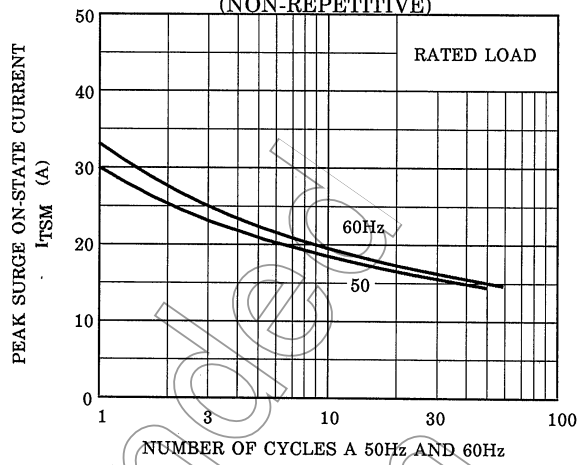

$i_T - v_T$

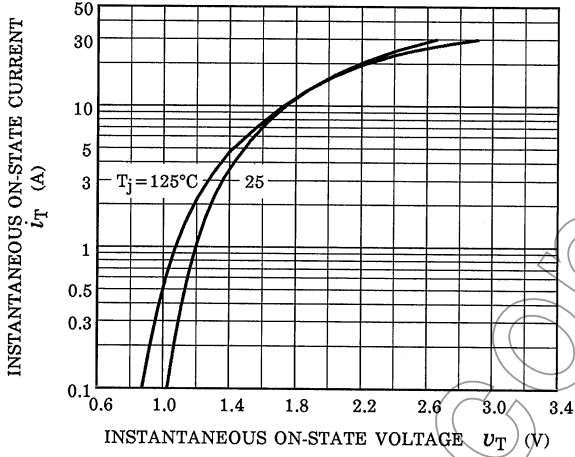

$I_{GT}(T_c) / I_{GT}(T_c = 25^\circ C) - T_c$  (TYPICAL)

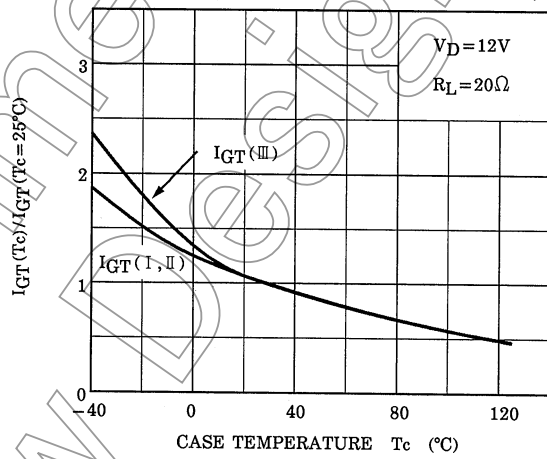

$V_{GT}(T_c) / V_{GT}(T_c = 25^\circ C) - T_c$  (TYPICAL)

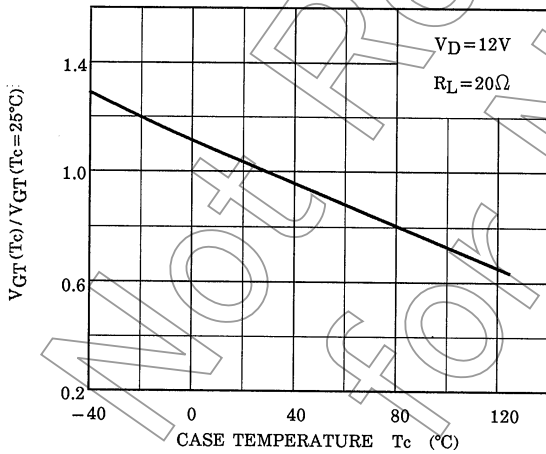

$I_H(T_c) / I_H(T_c = 25^\circ C) - T_c$  (TYPICAL)

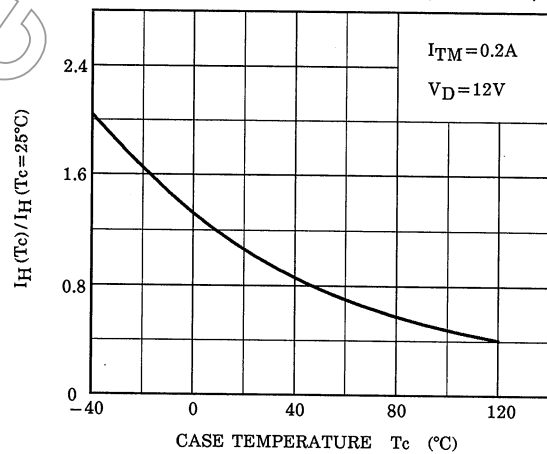

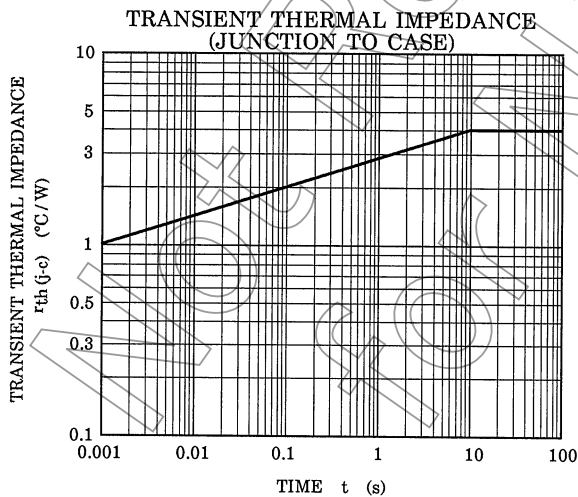
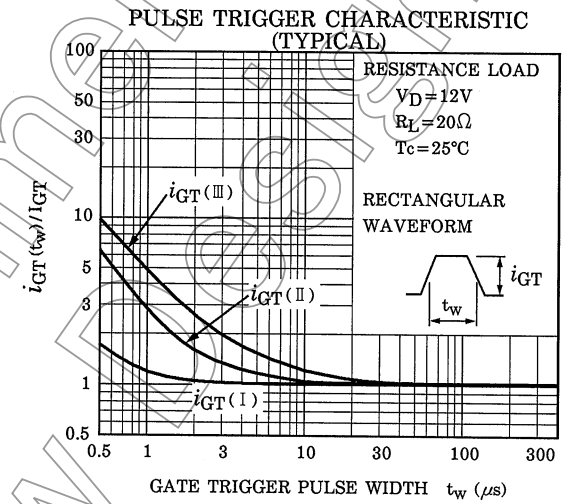
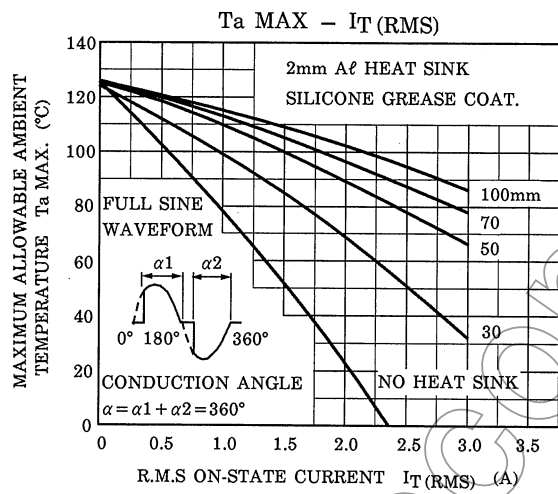
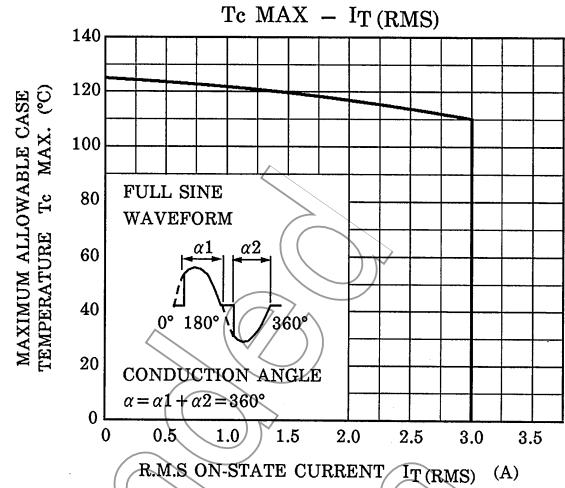
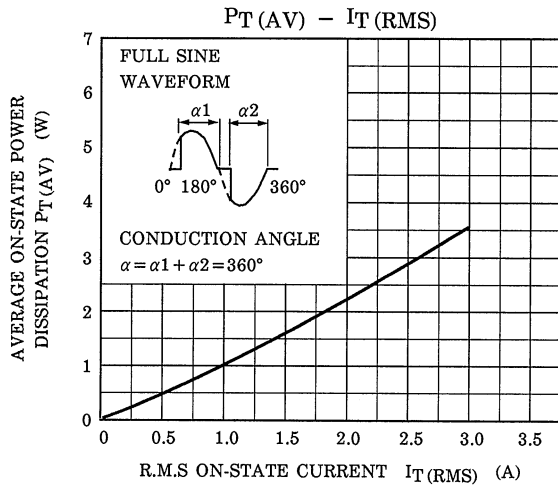

**RESTRICTIONS ON PRODUCT USE**

20070701-EN

- The information contained herein is subject to change without notice.
- TOSHIBA is continually working to improve the quality and reliability of its products. Nevertheless, semiconductor devices in general can malfunction or fail due to their inherent electrical sensitivity and vulnerability to physical stress. It is the responsibility of the buyer, when utilizing TOSHIBA products, to comply with the standards of safety in making a safe design for the entire system, and to avoid situations in which a malfunction or failure of such TOSHIBA products could cause loss of human life, bodily injury or damage to property.  
In developing your designs, please ensure that TOSHIBA products are used within specified operating ranges as set forth in the most recent TOSHIBA products specifications. Also, please keep in mind the precautions and conditions set forth in the "Handling Guide for Semiconductor Devices," or "TOSHIBA Semiconductor Reliability Handbook" etc.
- The TOSHIBA products listed in this document are intended for usage in general electronics applications (computer, personal equipment, office equipment, measuring equipment, industrial robotics, domestic appliances, etc.). These TOSHIBA products are neither intended nor warranted for usage in equipment that requires extraordinarily high quality and/or reliability or a malfunction or failure of which may cause loss of human life or bodily injury ("Unintended Usage"). Unintended Usage include atomic energy control instruments, airplane or spaceship instruments, transportation instruments, traffic signal instruments, combustion control instruments, medical instruments, all types of safety devices, etc.. Unintended Usage of TOSHIBA products listed in this document shall be made at the customer's own risk.
- The products described in this document shall not be used or embedded to any downstream products of which manufacture, use and/or sale are prohibited under any applicable laws and regulations.
- The information contained herein is presented only as a guide for the applications of our products. No responsibility is assumed by TOSHIBA for any infringements of patents or other rights of the third parties which may result from its use. No license is granted by implication or otherwise under any patents or other rights of TOSHIBA or the third parties.
- Please contact your sales representative for product-by-product details in this document regarding RoHS compatibility. Please use these products in this document in compliance with all applicable laws and regulations that regulate the inclusion or use of controlled substances. Toshiba assumes no liability for damage or losses occurring as a result of noncompliance with applicable laws and regulations.