

LOW-VOLTAGE RAIL-TO-RAIL OUTPUT OPERATIONAL AMPLIFIERS

 Check for Samples: [LMV321 SINGLE](#), [LMV358 DUAL](#), [LMV324 QUAD](#), [LMV324S QUAD WITH SHUTDOWN](#)

FEATURES

- **2.7-V and 5-V Performance**
- **–40°C to 125°C Operation**
- **Low-Power Shutdown Mode (LMV324S)**
- **No Crossover Distortion**
- **Low Supply Current**
 - LMV321 . . . 130 μ A Typ
 - LMV358 . . . 210 μ A Typ
 - LMV324 . . . 410 μ A Typ
 - LMV324S . . . 410 μ A Typ
- **Rail-to-Rail Output Swing**
- **ESD Protection Exceeds JESD 22**
 - 2000-V Human-Body Model (A114-A)
 - 1000-V Charged-Device Model (C101)

DESCRIPTION/ ORDERING INFORMATION

The LMV321, LMV358, and LMV324/LMV324S are single, dual, and quad low-voltage (2.7 V to 5.5 V) operational amplifiers with rail-to-rail output swing. The LMV324S, which is a variation of the standard LMV324, includes a power-saving shutdown feature that reduces supply current to a maximum of 5 μ A per channel when the amplifiers are not needed. Channels 1 and 2 together are put in shutdown, as are channels 3 and 4. While in shutdown, the outputs actively are pulled low.

The LMV321, LMV358, LMV324, and LMV324S are the most cost-effective solutions for applications where low-voltage operation, space saving, and low cost are needed. These amplifiers are designed specifically for low-voltage (2.7 V to 5 V) operation, with performance specifications meeting or exceeding the LM358 and LM324 devices that operate from 5 V to 30 V. Additional features of the LMV3xx devices are a common-mode input voltage range that includes ground, 1-MHz unity-gain bandwidth, and 1-V/ μ s slew rate.

The LMV321 is available in the ultra-small DCK (SC-70) package, which is approximately one-half the size of the DBV (SOT-23) package. This package saves space on printed circuit boards and enables the design of small portable electronic devices. It also allows the designer to place the device closer to the signal source to reduce noise pickup and increase signal integrity.

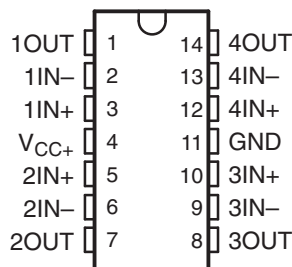
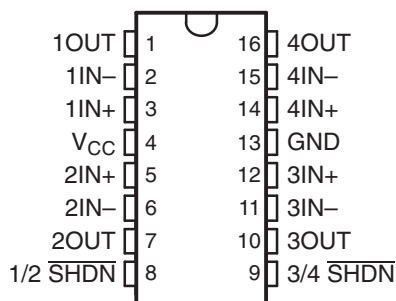
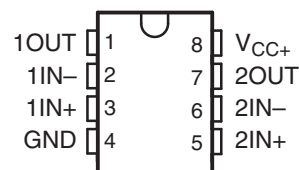
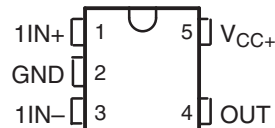
**LMV324 . . . D (SOIC) OR PW (TSSOP) PACKAGE
(TOP VIEW)**

**LMV324S . . . D (SOIC) OR PW (TSSOP) PACKAGE
(TOP VIEW)**

**LMV358 . . . D (SOIC), DDU (VSSOP),
DGK (MSOP), OR PW (TSSOP) PACKAGE
(TOP VIEW)**

**LMV321 . . . DBV (SOT-23) OR DCK (SC-70) PACKAGE
(TOP VIEW)**

Please be aware that an important notice concerning availability, standard warranty, and use in critical applications of Texas Instruments semiconductor products and disclaimers thereto appears at the end of this data sheet.

ORDERING INFORMATION⁽¹⁾

T _A	PACKAGE ⁽²⁾		ORDERABLE PART NUMBER	TOP-SIDE MARKING ⁽³⁾
–40°C to 85°C	Single	SC-70 – DCK	Reel of 3000	LMV321IDCKR
			Reel of 250	LMV321IDCKT
–40°C to 125°C	Single	SOT-23 – DBV	Reel of 3000	LMV321IDBVR
			Reel of 250	LMV321IDBVT
–40°C to 125°C	Dual	MSOP/VSSOP – DGK	Reel of 2500	LMV358IDGKR
			Reel of 250	LMV358IDGKT
			Tube of 75	LMV358ID
			Reel of 2500	LMV358IDR
		SOIC – D	Tube of 150	LMV358IPW
			Reel of 2000	LMV358IPWR
		TSSOP – PW	Reel of 2000	LMV358IPWR
			Reel of 2000	LMV358IPWR
VSSOP – DDU	Reel of 3000	LMV358ID DUR		
–40°C to 125°C	Quad	SOIC – D	Tube of 50	LMV324ID
			Reel of 2500	LMV324IDR
–40°C to 85°C	Quad	SOIC – D	Tube of 50	LMV324SID
			Reel of 2500	LMV324SIDR
–40°C to 125°C	Quad	TSSOP – PW	Reel of 2000	LMV324IPWR
			Reel of 2000	LMV324SIPWR
–40°C to 125°C	Dual	MSOP/VSSOP – DGK	Reel of 2500	LMV358QDGKR
			Reel of 250	LMV358QDGKT
			Tube of 75	LMV358QD
			Reel of 2500	LMV358QDR
		SOIC – D	Tube of 150	LMV358QPW
			Reel of 2000	LMV358QPWR
		TSSOP – PW	Reel of 2000	LMV358QPWR
			Reel of 2000	LMV358QPWR
	VSSOP – DDU	Reel of 3000	LMV358QDDUR	
	Quad	SOIC – D	Tube of 50	LMV324QD
			Reel of 2500	LMV324QDR
		TSSOP – PW	Tube of 90	LMV324QPW
Reel of 2000			LMV324QPWR	

- (1) For the most current package and ordering information, see the Package Option Addendum at the end of this document, or see the TI web site at www.ti.com.
- (2) Package drawings, thermal data, and symbolization are available at www.ti.com/packaging.
- (3) DBV/DCK/DDU/DGK: The actual top-side marking has one additional character that designates the wafer fab/assembly site.

SYMBOL (EACH AMPLIFIER)

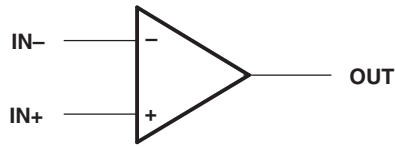

LMV324 SIMPLIFIED SCHEMATIC

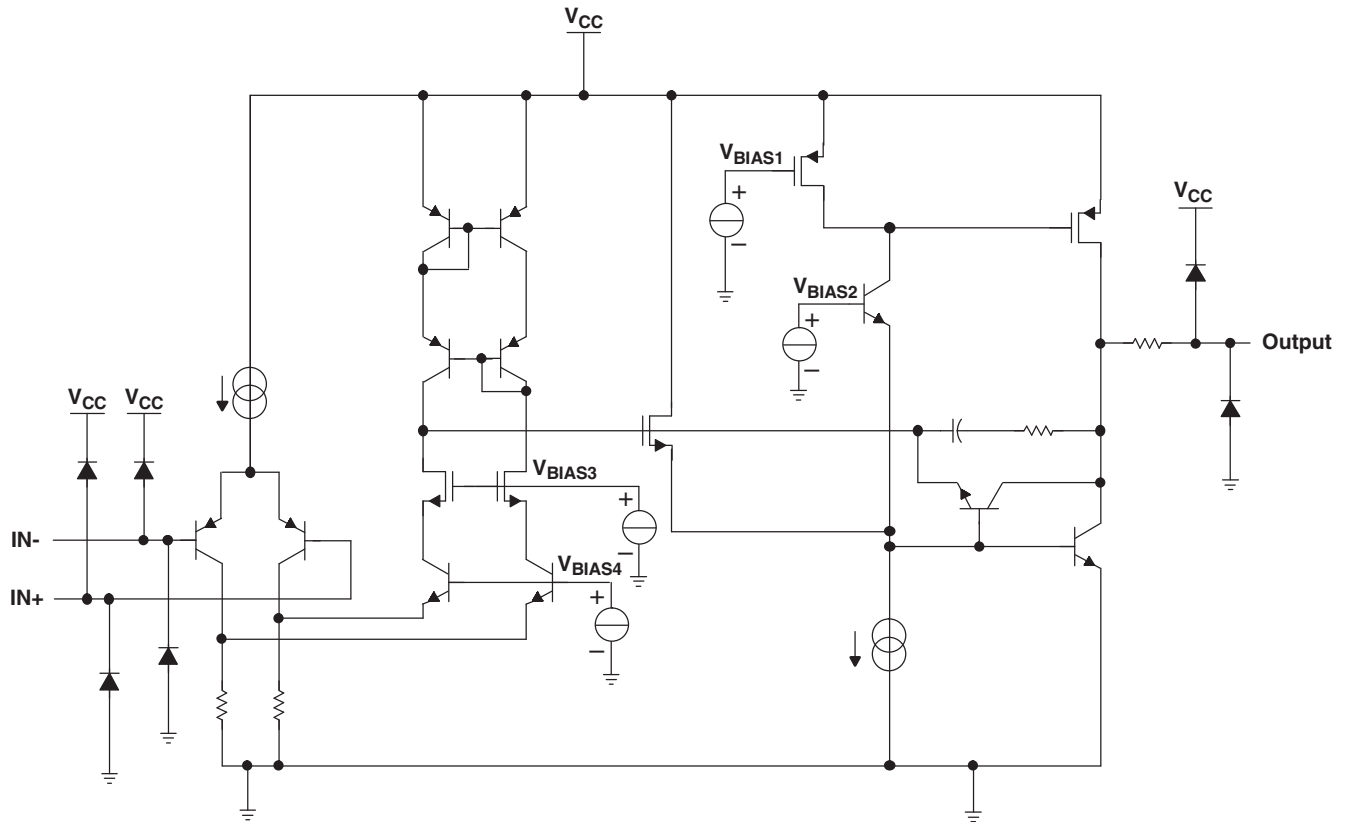

Absolute Maximum Ratings⁽¹⁾

over operating free-air temperature range (unless otherwise noted)

		MIN	MAX	UNIT	
V _{CC}	Supply voltage ⁽²⁾		5.5	V	
V _{ID}	Differential input voltage ⁽³⁾		±5.5	V	
V _I	Input voltage range (either input)	-0.2	5.5	V	
	Duration of output short circuit (one amplifier) to ground ⁽⁴⁾	At or below T _A = 25°C, V _{CC} ≤ 5.5 V		Unlimited	
θ _{JA}	Package thermal impedance ^{(5) (6)}	D package	8 pin	97	°C/W
			14 pin	86	
			16 pin	73	
		DBV package	5 pin	206	
		DCK package	5 pin	252	
		DDU package	8 pin	210	
		DGK package	8 pin	172	
		PW package	8 pin	149	
		14 pin	113		
		16 pin	108		
T _J	Operating virtual junction temperature		150	°C	
T _{stg}	Storage temperature range	-65	150	°C	

- (1) Stresses beyond those listed under *Absolute Maximum Ratings* may cause permanent damage to the device. These are stress ratings only, and functional operation of the device at these or any other conditions beyond those indicated under *Recommended Operating Conditions* is not implied. Exposure to absolute-maximum-rated conditions for extended periods may affect device reliability.
- (2) All voltage values (except differential voltages and V_{CC} specified for the measurement of I_{OS}) are with respect to the network GND.
- (3) Differential voltages are at IN+ with respect to IN-.
- (4) Short circuits from outputs to V_{CC} can cause excessive heating and eventual destruction.
- (5) Maximum power dissipation is a function of T_{J(max)}, θ_{JA}, and T_A. The maximum allowable power dissipation at any allowable ambient temperature is P_D = (T_{J(max)} - T_A)/θ_{JA}. Operating at the absolute maximum T_J of 150°C can affect reliability.
- (6) The package thermal impedance is calculated in accordance with JESD 51-7.

Recommended Operating Conditions⁽¹⁾

		MIN	MAX	UNIT	
V _{CC}	Supply voltage (single-supply operation)	2.7	5.5	V	
V _{IH}	Amplifier turn-on voltage level (LMV324S) ⁽²⁾	V _{CC} = 2.7 V	1.7	V	
		V _{CC} = 5 V	3.5		
V _{IL}	Amplifier turn-off voltage level (LMV324S)	V _{CC} = 2.7 V	0.7	V	
		V _{CC} = 5 V	1.5		
T _A	Operating free-air temperature	I temperature (LMV321, LMV358, LMV324)	-40	125	°C
		I temperature (LMV324S, LMV321IDCK)	-40	85	
		Q temperature	-40	125	

- (1) All unused control inputs of the device must be held at V_{CC} or GND to ensure proper device operation. See the TI application report, *Implications of Slow or Floating CMOS Inputs*, literature number SCBA004.
- (2) V_{IH} should not be allowed to exceed V_{CC}.

Electrical Characteristics

 $V_{CC+} = 2.7\text{ V}$, $T_A = 25^\circ\text{C}$ (unless otherwise noted)

PARAMETER		TEST CONDITIONS		MIN	TYP ⁽¹⁾	MAX	UNIT
V_{IO}	Input offset voltage				1.7	7	mV
α_{VIO}	Average temperature coefficient of input offset voltage				5		$\mu\text{V}/^\circ\text{C}$
I_{IB}	Input bias current				11	250	nA
I_{IO}	Input offset current				5	50	nA
CMRR	Common-mode rejection ratio	$V_{CM} = 0$ to 1.7 V		50	63		dB
k_{SVR}	Supply-voltage rejection ratio	$V_{CC} = 2.7\text{ V}$ to 5 V, $V_O = 1\text{ V}$		50	60		dB
V_{ICR}	Common-mode input voltage range	CMRR ≥ 50 dB		0	-0.2		V
					1.9	1.7	
V_O	Output swing	$R_L = 10\text{ k}\Omega$ to 1.35 V	High level	$V_{CC} - 100$	$V_{CC} - 10$		mV
			Low level		60	180	
I_{CC}	Supply current	LMV321I			80	170	μA
		LMV358I (both amplifiers)			140	340	
		LMV324I/LMV324SI (all four amplifiers)			260	680	
B_1	Unity-gain bandwidth	$C_L = 200\text{ pF}$			1		MHz
Φ_m	Phase margin				60		deg
G_m	Gain margin				10		dB
V_n	Equivalent input noise voltage	$f = 1\text{ kHz}$			46		$\text{nV}/\sqrt{\text{Hz}}$
I_n	Equivalent input noise current	$f = 1\text{ kHz}$			0.17		$\text{pA}/\sqrt{\text{Hz}}$

(1) Typical values represent the likely parametric nominal values determined at the time of characterization. Typical values depend on the application and configuration and may vary over time. Typical values are not ensured on production material.

Shutdown Characteristics (LMV324S)

 $V_{CC+} = 2.7\text{ V}$, $T_A = 25^\circ\text{C}$ (unless otherwise noted)

PARAMETER		TEST CONDITIONS		MIN	TYP ⁽¹⁾	MAX	UNIT
$I_{CC(\text{SHDN})}$	Supply current in shutdown mode (per channel)	$\overline{\text{SHDN}} \leq 0.6\text{ V}$				5	μA
$t_{(\text{on})}$	Amplifier turn-on time	$A_V = 1$, $R_L = \text{Open}$ (measured at 50% point)			2		μs
$t_{(\text{off})}$	Amplifier turn-off time	$A_V = 1$, $R_L = \text{Open}$ (measured at 50% point)			40		ns

(1) Typical values represent the likely parametric nominal values determined at the time of characterization. Typical values depend on the application and configuration and may vary over time. Typical values are not ensured on production material.

Electrical Characteristics

V_{CC+} = 5 V, at specified free-air temperature (unless otherwise noted)

PARAMETER		TEST CONDITIONS		T _A ⁽¹⁾	MIN	TYP ⁽²⁾	MAX	UNIT
V _{IO}	Input offset voltage			25°C		1.7	7	mV
				Full range			9	
α _{VIO}	Average temperature coefficient of input offset voltage			25°C		5		μV/°C
I _{IB}	Input bias current			25°C		15	250	nA
				Full range			500	
I _{IO}	Input offset current			25°C		5	50	nA
				Full range			150	
CMRR	Common-mode rejection ratio	V _{CM} = 0 to 4 V		25°C	50	65		dB
k _{SVR}	Supply-voltage rejection ratio	V _{CC} = 2.7 V to 5 V, V _O = 1 V, V _{CM} = 1 V		25°C	50	60		dB
V _{ICR}	Common-mode input voltage range	CMRR ≥ 50 dB		25°C	0	-0.2		V
						4.2	4	
V _O	Output swing	R _L = 2 kΩ to 2.5 V	High level	25°C	V _{CC} - 300	V _{CC} - 40		mV
				Full range		V _{CC} - 400		
			Low level	25°C		120	300	
				Full range			400	
		R _L = 10 kΩ to 2.5 V	High level	25°C	V _{CC} - 100	V _{CC} - 10		
				Full range		V _{CC} - 200		
			Low level	25°C		65	180	
				Full range			280	
A _{VD}	Large-signal differential voltage gain	R _L = 2 kΩ		25°C	15	100		V/mV
				Full range		10		
I _{OS}	Output short-circuit current	Sourcing, V _O = 0 V		25°C	5	60		mA
		Sinking, V _O = 5 V						
I _{CC}	Supply current	LMV321I		25°C		130	250	μA
				Full range			350	
		LMV358I (both amplifiers)		25°C		210	440	
				Full range			615	
		LMV324I/LMV324SI (all four amplifiers)		25°C		410	830	
				Full range			1160	
B ₁	Unity-gain bandwidth	C _L = 200 pF		25°C		1		MHz
Φ _m	Phase margin			25°C		60		deg
G _m	Gain margin			25°C		10		dB
V _n	Equivalent input noise voltage	f = 1 kHz		25°C		39		nV/√Hz
I _n	Equivalent input noise current	f = 1 kHz		25°C		0.21		pA/√Hz
SR	Slew rate			25°C		1		V/μs

- (1) Full range T_A = -40°C to 125°C for I temperature (LMV321, LMV358, LMV324), -40°C to 85°C for (LMV324S, LMV321IDCK) and -40°C to 125°C for Q temperature.
- (2) Typical values represent the likely parametric nominal values determined at the time of characterization. Typical values depend on the application and configuration and may vary over time. Typical values are not ensured on production material.

Shutdown Characteristics (LMV324S)

$V_{CC+} = 5\text{ V}$, $T_A = 25^\circ\text{C}$ (unless otherwise noted)

PARAMETER		TEST CONDITIONS	MIN	TYP ⁽¹⁾	MAX	UNIT
$I_{CC(\text{SHDN})}$	Supply current in shutdown mode (per channel)	$\overline{\text{SHDN}} \leq 0.6\text{ V}$, $T_A = \text{Full Temperature Range}$			5	μA
$t_{(\text{on})}$	Amplifier turn-on time	$A_V = 1$, $R_L = \text{Open}$ (measured at 50% point)		2		μs
$t_{(\text{off})}$	Amplifier turn-off time	$A_V = 1$, $R_L = \text{Open}$ (measured at 50% point)		40		ns

(1) Typical values represent the likely parametric nominal values determined at the time of characterization. Typical values depend on the application and configuration and may vary over time. Typical values are not ensured on production material.

TYPICAL CHARACTERISTICS

LMV321 FREQUENCY RESPONSE
VS
RESISTIVE LOAD

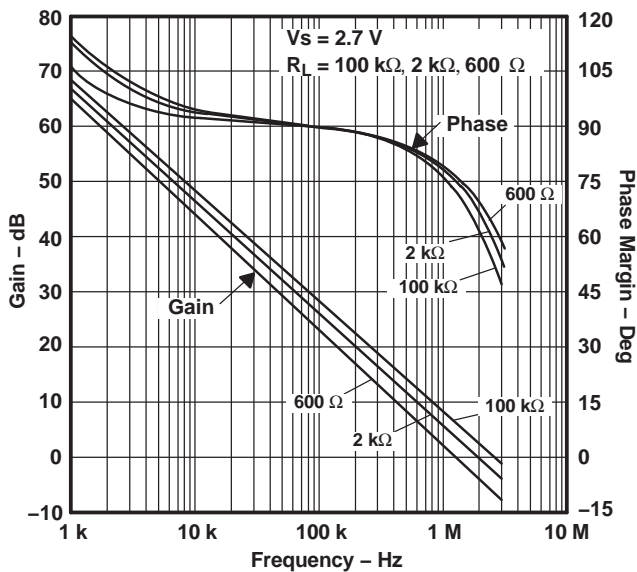

Figure 1.

LMV321 FREQUENCY RESPONSE
VS
RESISTIVE LOAD

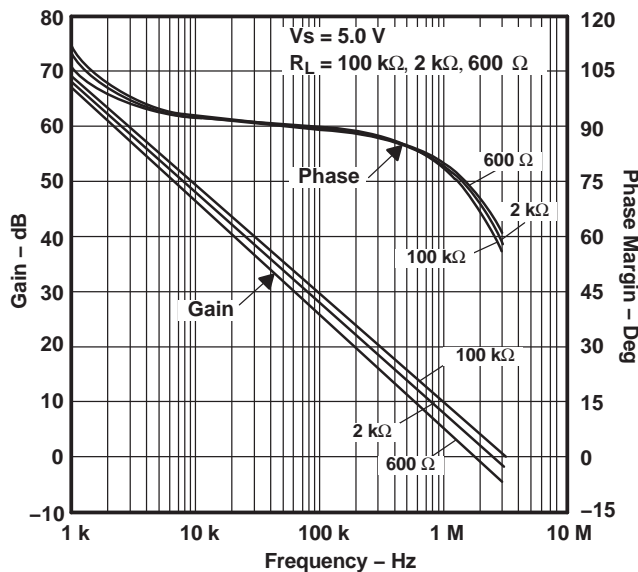

Figure 2.

LMV321 FREQUENCY RESPONSE
VS
CAPACITIVE LOAD

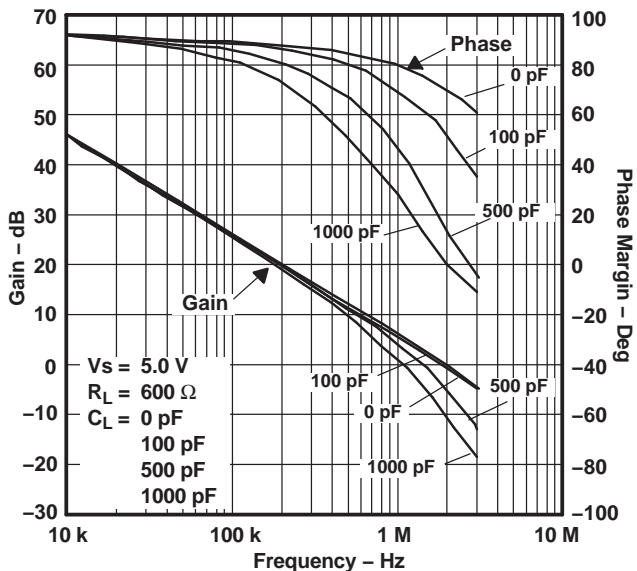

Figure 3.

LMV321 FREQUENCY RESPONSE
VS
CAPACITIVE LOAD

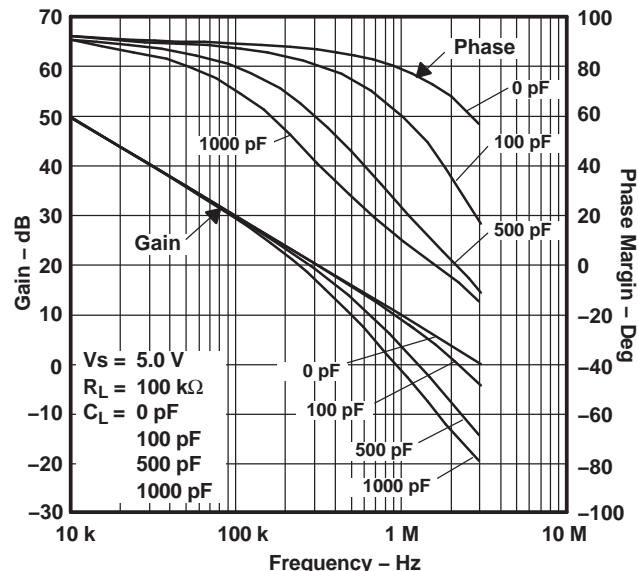

Figure 4.

TYPICAL CHARACTERISTICS (continued)

LMV321 FREQUENCY RESPONSE
VS
TEMPERATURE

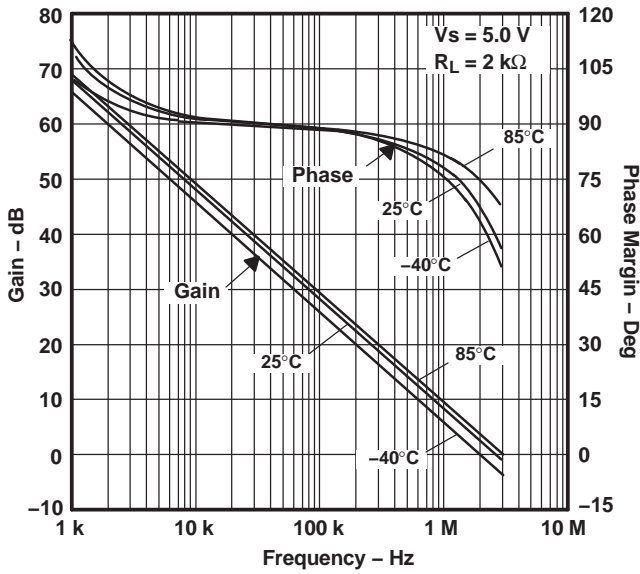

Figure 5.

STABILITY
VS
CAPACITIVE LOAD

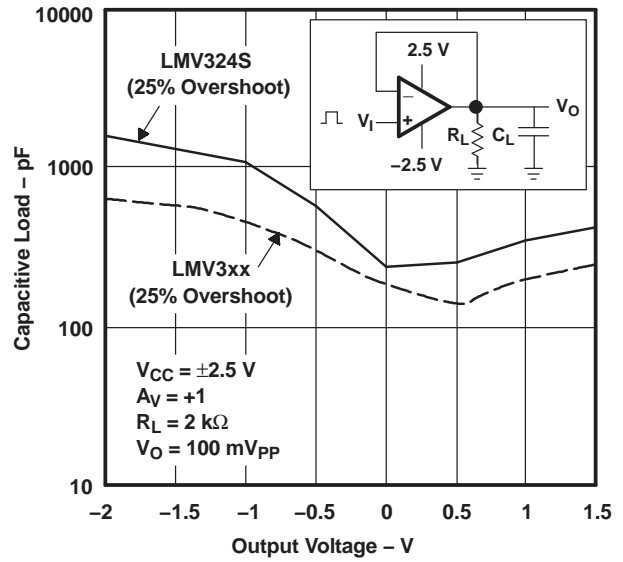

Figure 6.

STABILITY
VS
CAPACITIVE LOAD

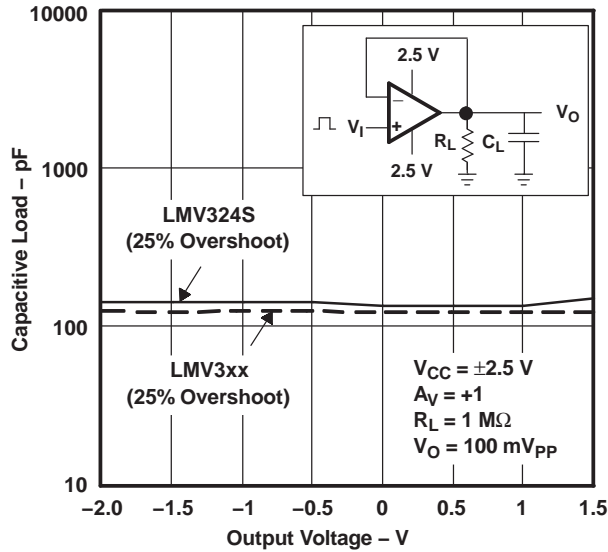

Figure 7.

STABILITY
VS
CAPACITIVE LOAD

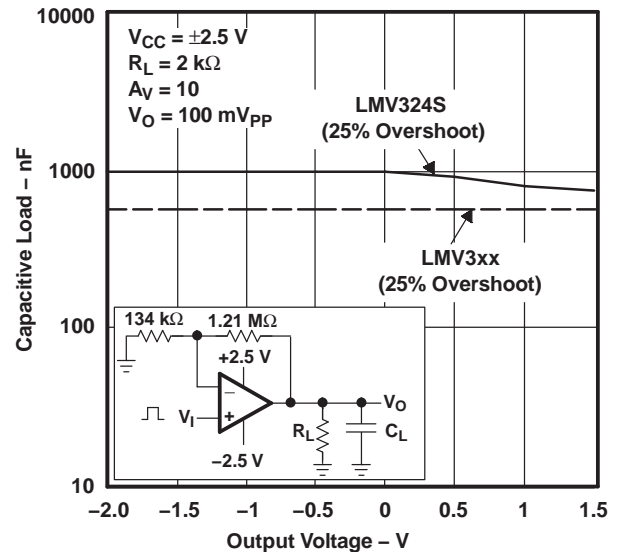
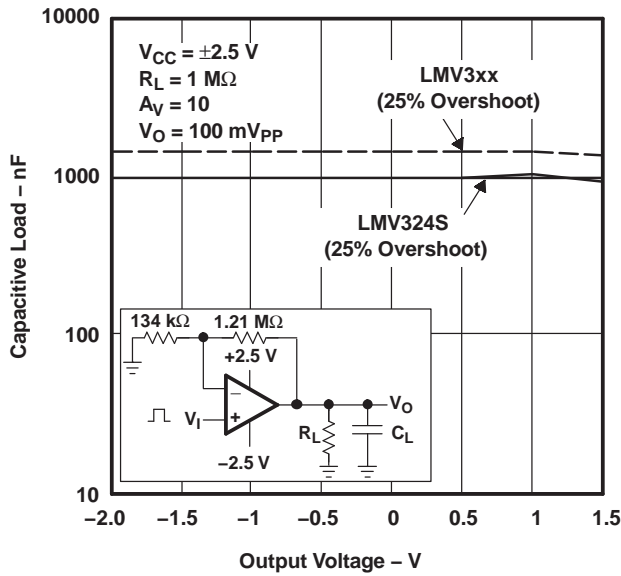

Figure 8.

TYPICAL CHARACTERISTICS (continued)

STABILITY
vs
CAPACITIVE LOAD



SLEW RATE
vs
SUPPLY VOLTAGE

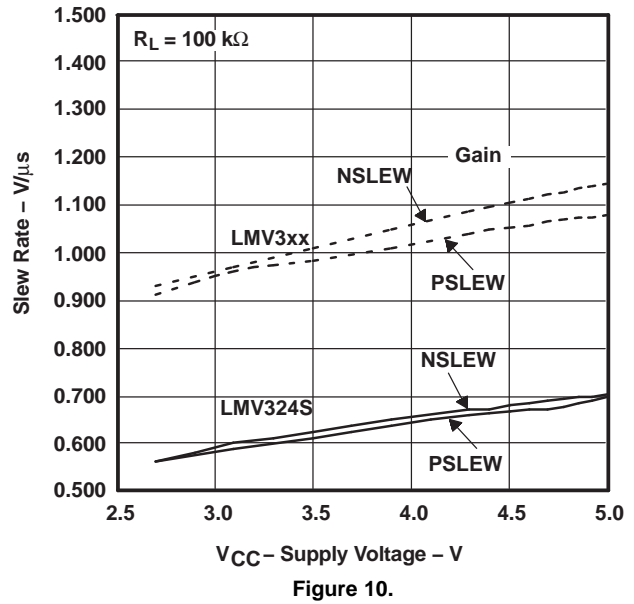

SUPPLY CURRENT
vs
SUPPLY VOLTAGE – QUAD AMPLIFIER

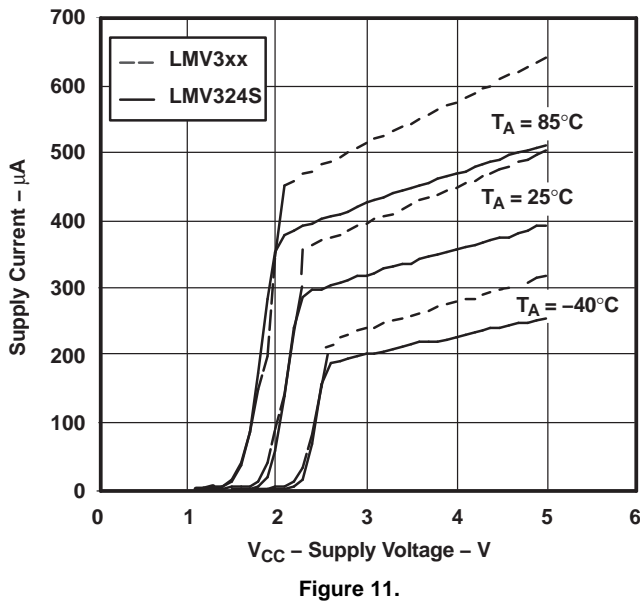

INPUT CURRENT
vs
TEMPERATURE

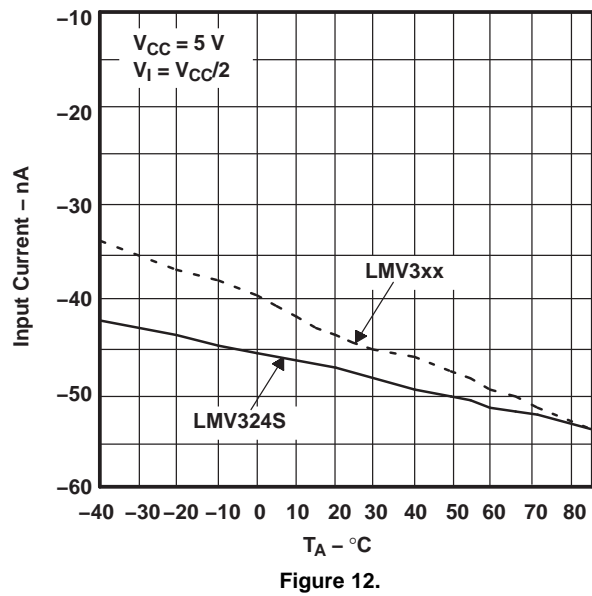

TYPICAL CHARACTERISTICS (continued)

SOURCE CURRENT
vs
OUTPUT VOLTAGE

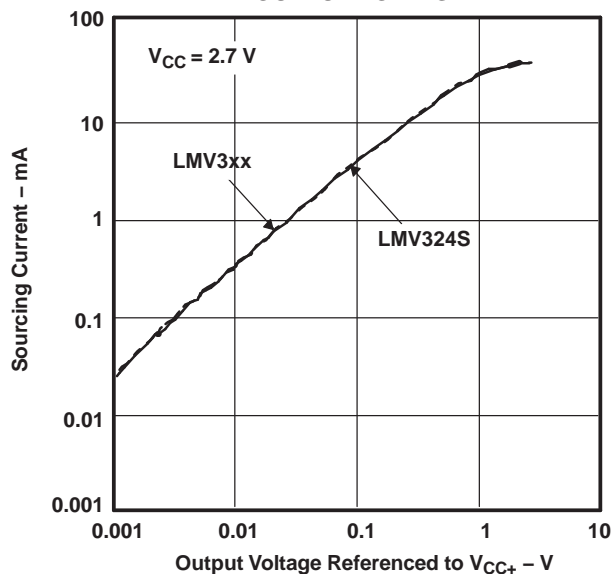

Figure 13.

SOURCE CURRENT
vs
OUTPUT VOLTAGE

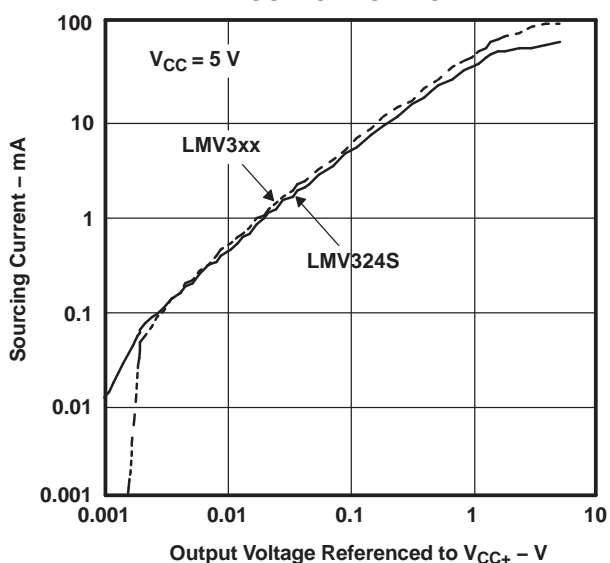

Figure 14.

SINKING CURRENT
vs
OUTPUT VOLTAGE

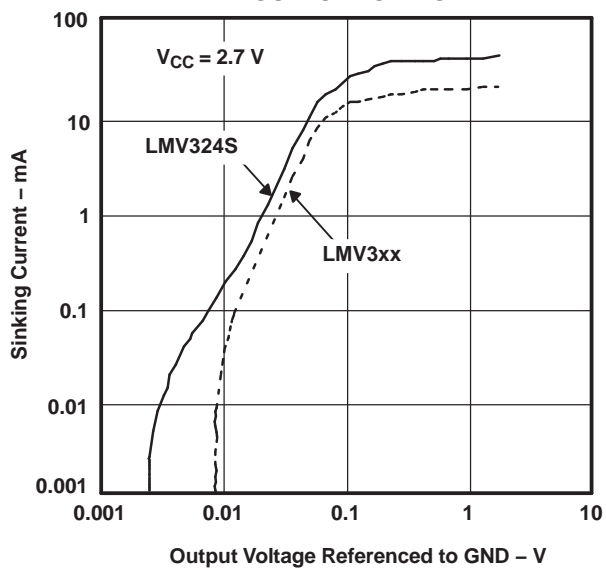

Figure 15.

SINKING CURRENT
vs
OUTPUT VOLTAGE

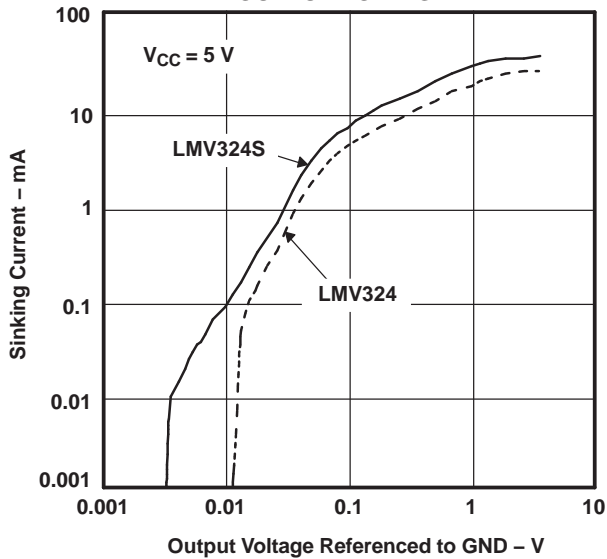

Figure 16.

TYPICAL CHARACTERISTICS (continued)
 SHORT-CIRCUIT CURRENT
 vs
 TEMPERATURE

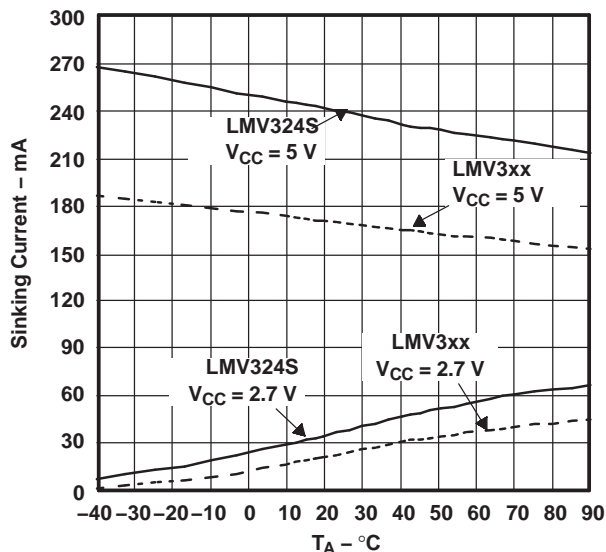

Figure 17.

TYPICAL CHARACTERISTICS (continued)
 SHORT-CIRCUIT CURRENT
 vs
 TEMPERATURE

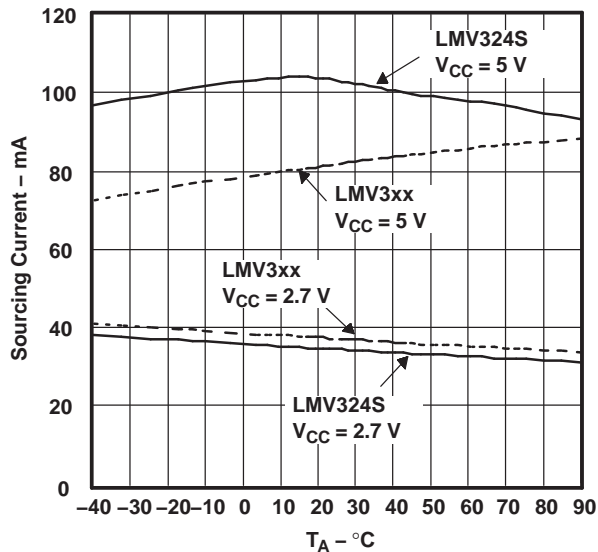

Figure 18.

TYPICAL CHARACTERISTICS (continued)
 $-k_{SVR}$
 vs
 FREQUENCY

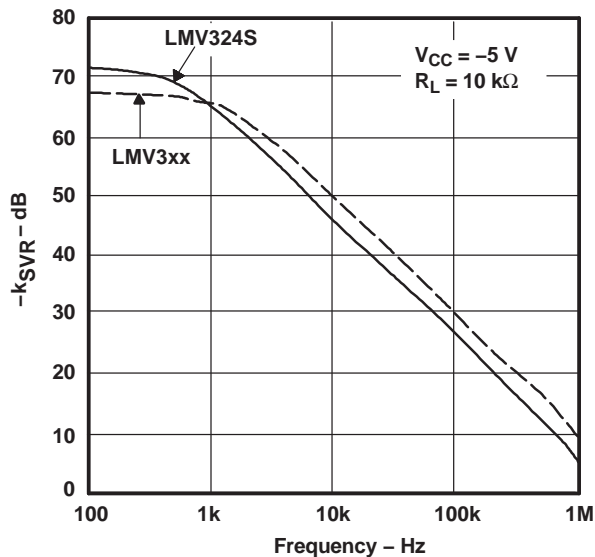

Figure 19.

TYPICAL CHARACTERISTICS (continued)
 $+k_{SVR}$
 vs
 FREQUENCY

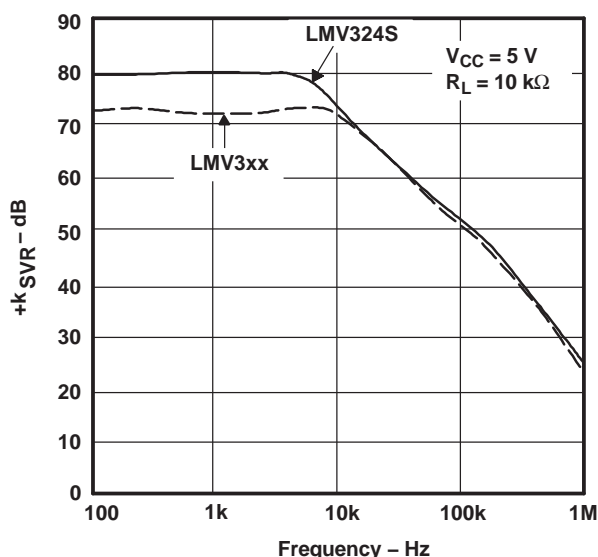

Figure 20.

TYPICAL CHARACTERISTICS (continued)

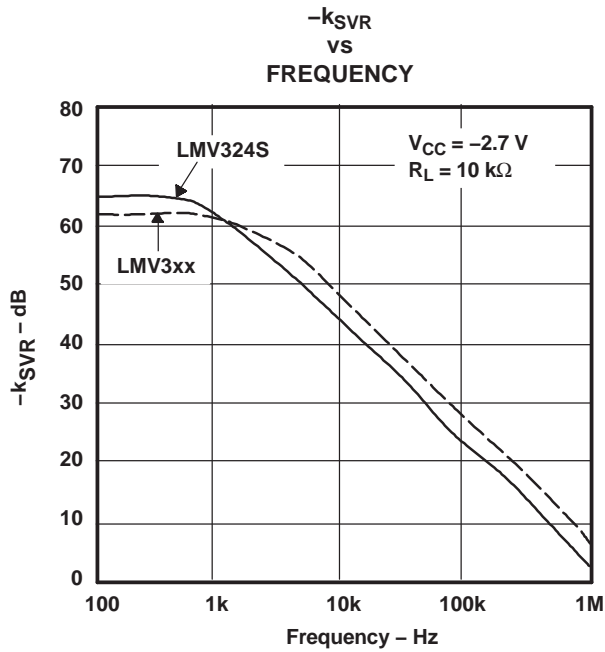

Figure 21.

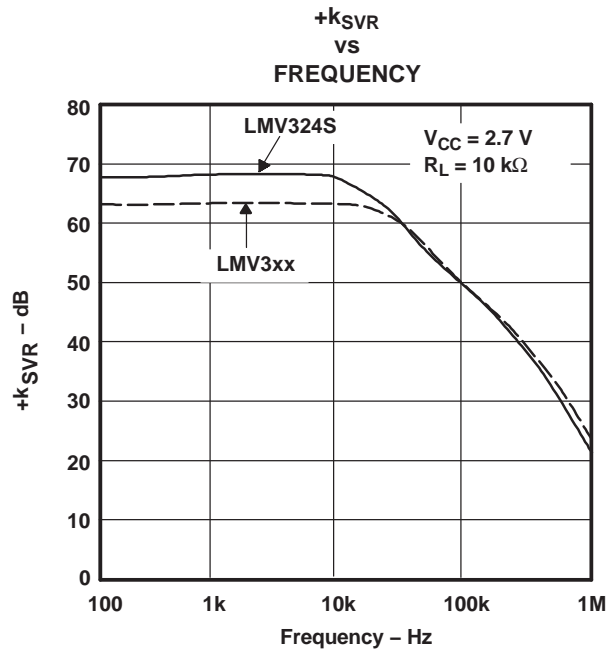

Figure 22.

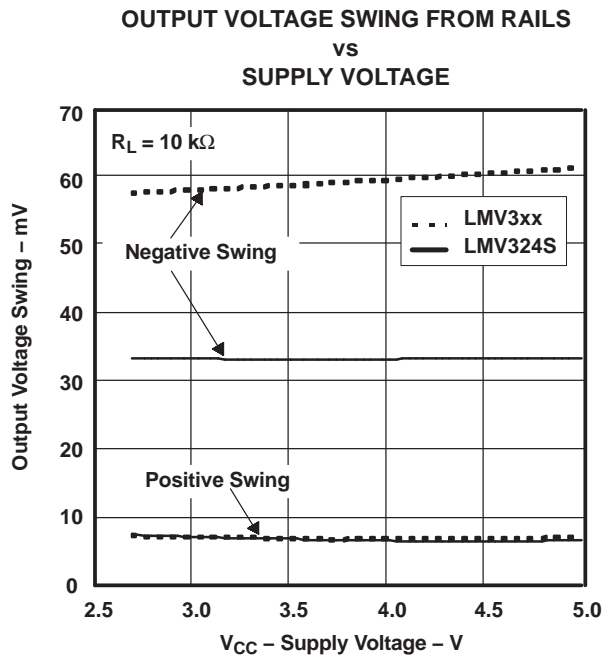

Figure 23.

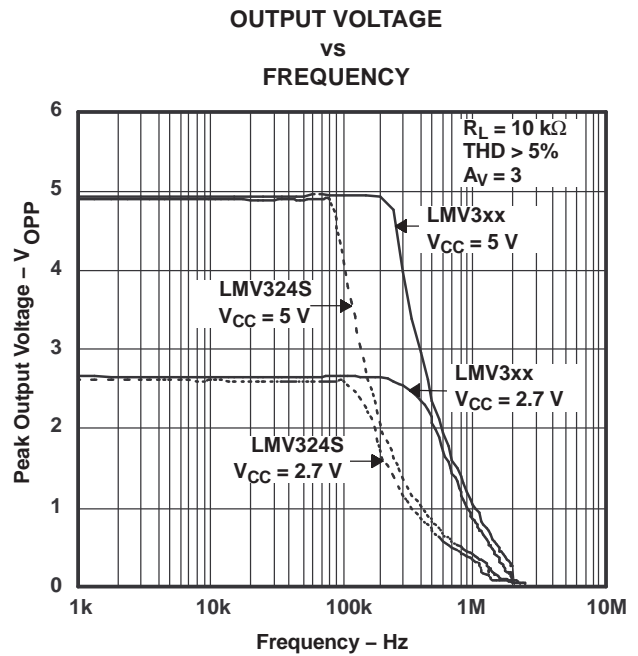

Figure 24.

TYPICAL CHARACTERISTICS (continued)

OPEN-LOOP OUTPUT IMPEDANCE

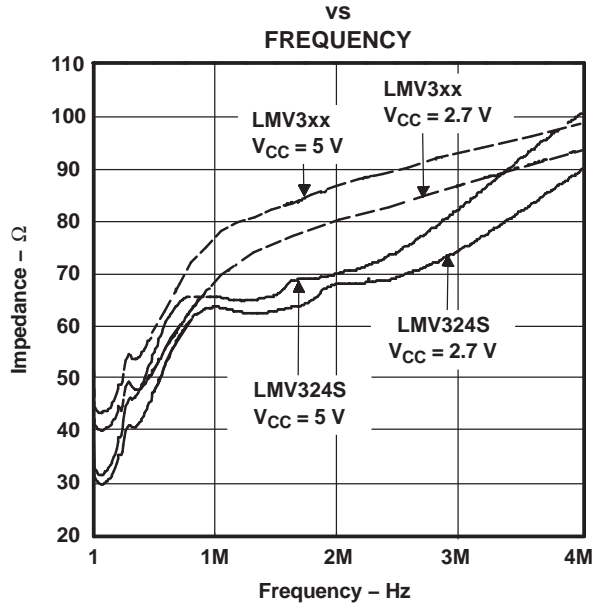

Figure 25.

CROSSTALK REJECTION

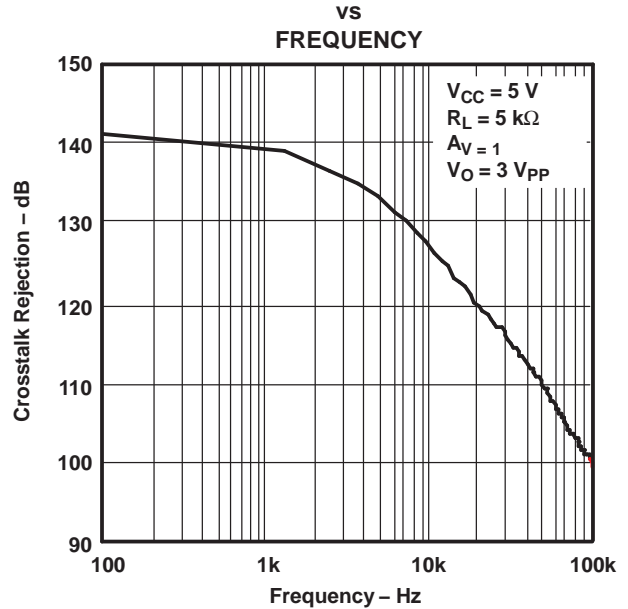
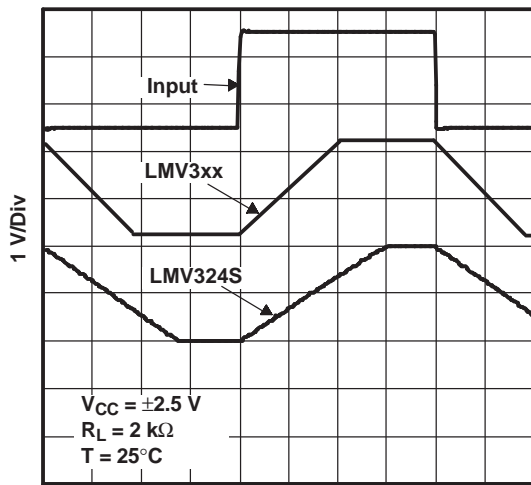

Figure 26.

NONINVERTING LARGE-SIGNAL PULSE RESPONSE



1 $\mu\text{s}/\text{Div}$
 Figure 27.

NONINVERTING LARGE-SIGNAL PULSE RESPONSE

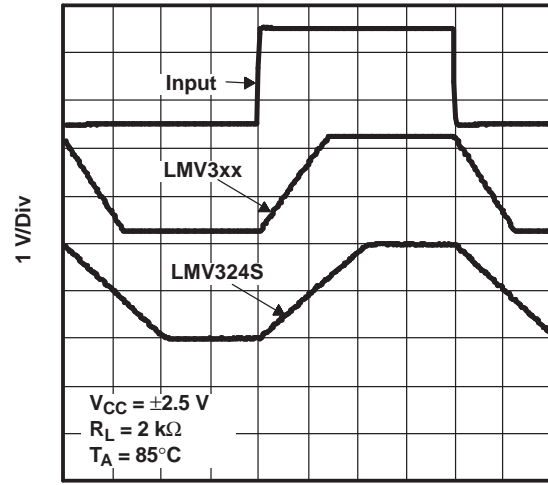

1 $\mu\text{s}/\text{Div}$
 Figure 28.

TYPICAL CHARACTERISTICS (continued)

NONINVERTING LARGE-SIGNAL PULSE RESPONSE

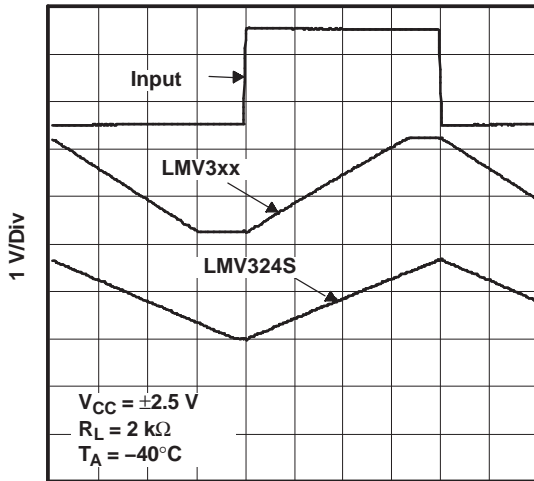

1 $\mu\text{s}/\text{Div}$
Figure 29.

NONINVERTING SMALL-SIGNAL PULSE RESPONSE

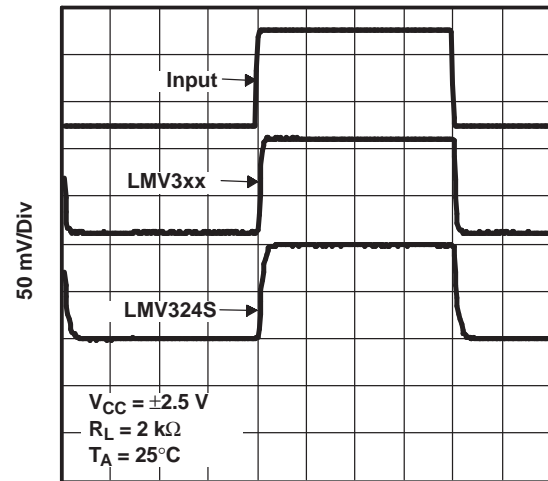

1 $\mu\text{s}/\text{Div}$
Figure 30.

NONINVERTING SMALL-SIGNAL PULSE RESPONSE

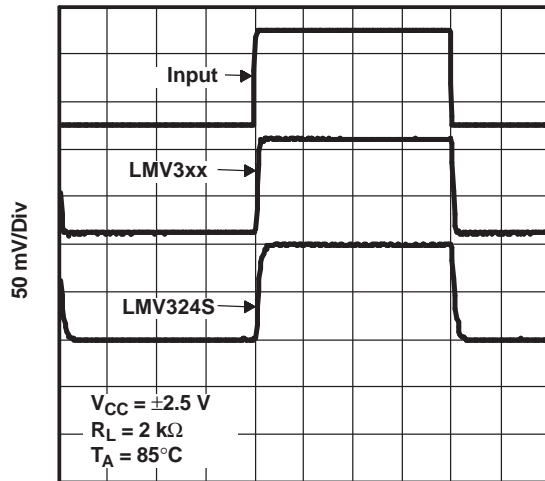

1 $\mu\text{s}/\text{Div}$
Figure 31.

NONINVERTING SMALL-SIGNAL PULSE RESPONSE

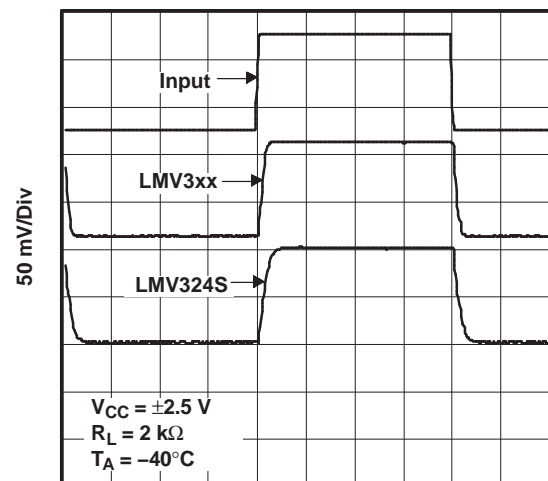

1 $\mu\text{s}/\text{Div}$
Figure 32.

TYPICAL CHARACTERISTICS (continued)

INVERTING LARGE-SIGNAL
 PULSE RESPONSE

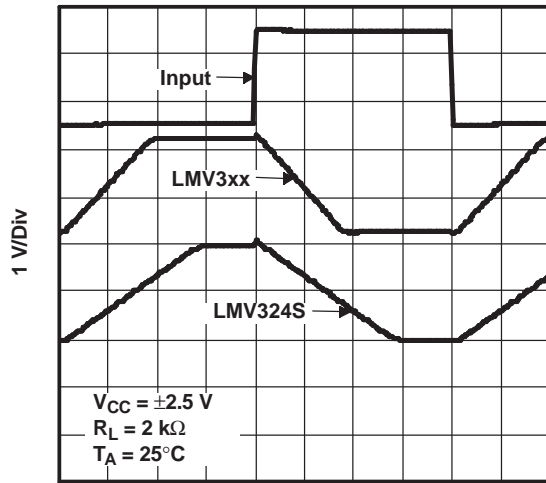

1 μs/Div
 Figure 33.

INVERTING LARGE-SIGNAL
 PULSE RESPONSE

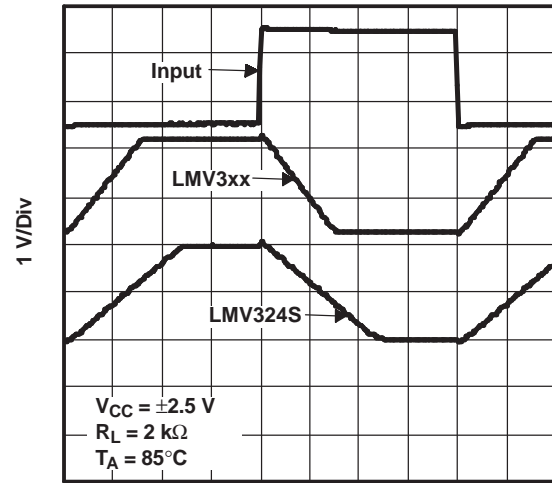

1 μs/Div
 Figure 34.

INVERTING LARGE-SIGNAL
 PULSE RESPONSE

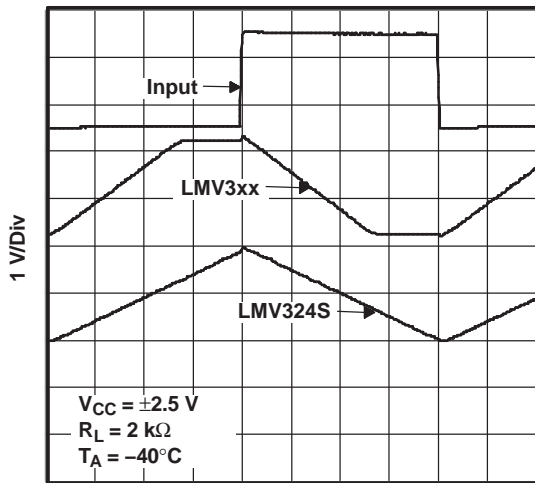

1 μs/Div
 Figure 35.

INVERTING SMALL-SIGNAL
 PULSE RESPONSE

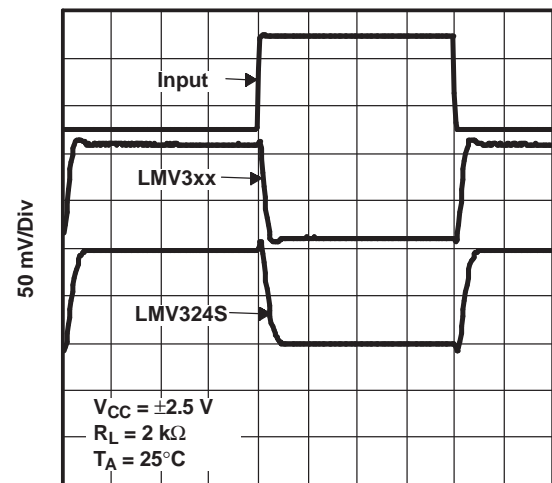

1 μs/Div
 Figure 36.

TYPICAL CHARACTERISTICS (continued)

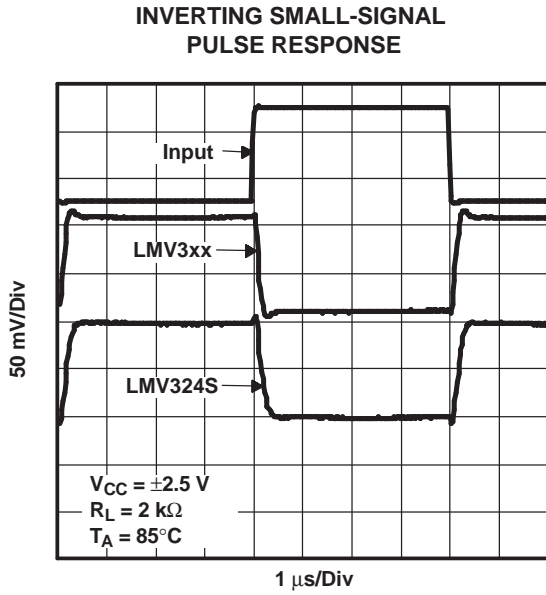

Figure 37.

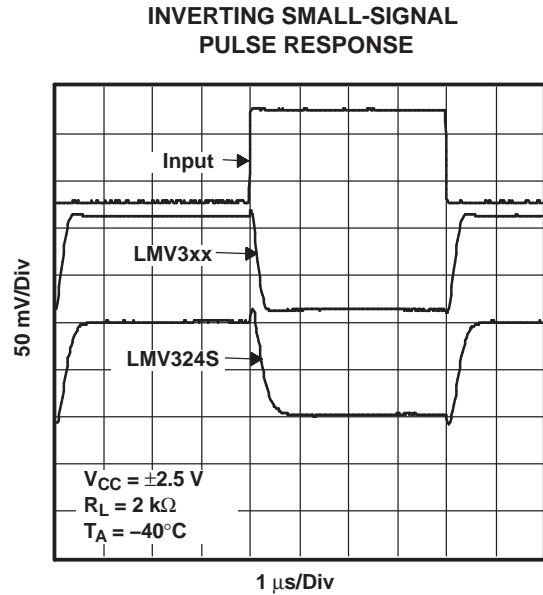

Figure 38.

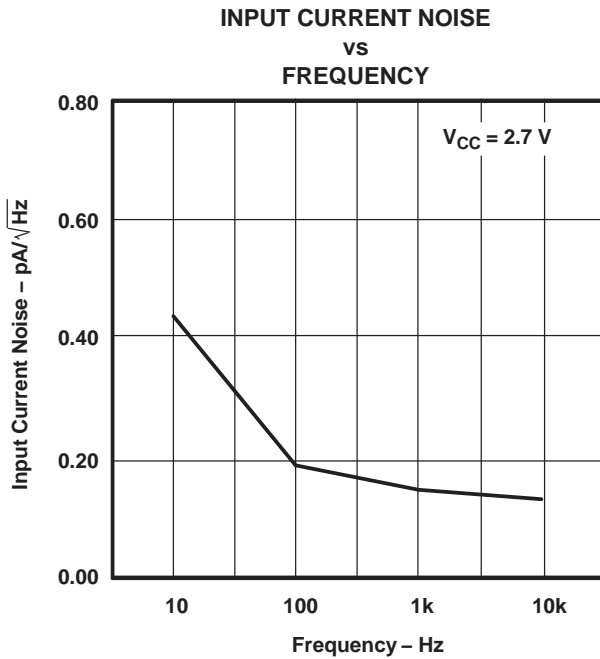

Figure 39.

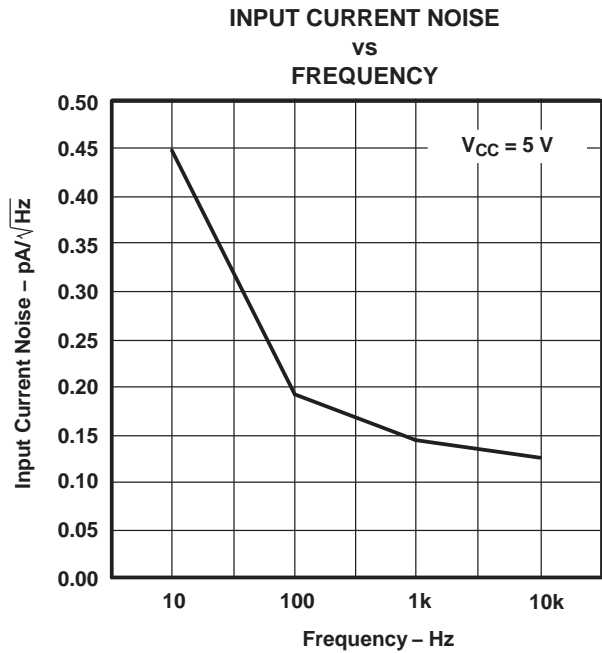

Figure 40.

TYPICAL CHARACTERISTICS (continued)

INPUT VOLTAGE NOISE
 vs
 FREQUENCY

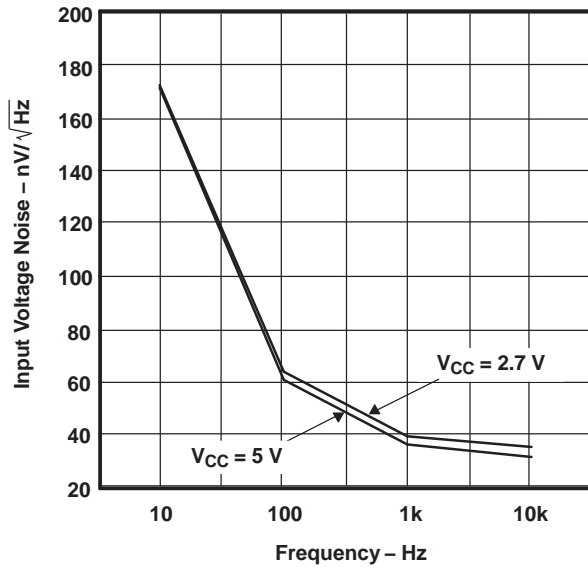

Figure 41.

THD + N
 vs
 FREQUENCY

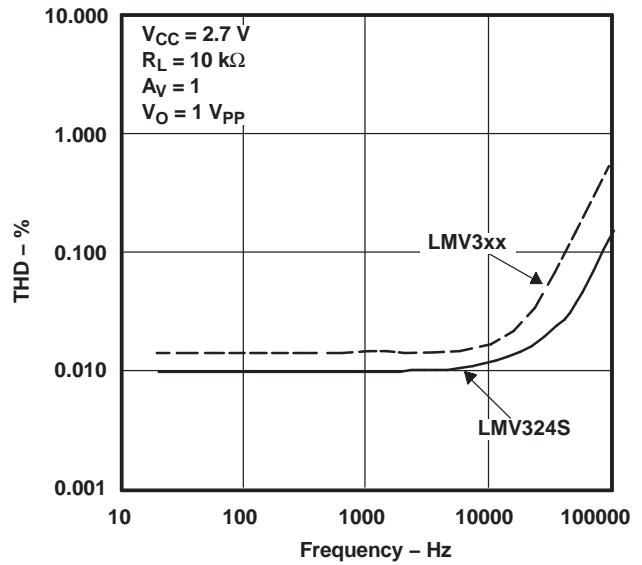

Figure 42.

THD + N
 vs
 FREQUENCY

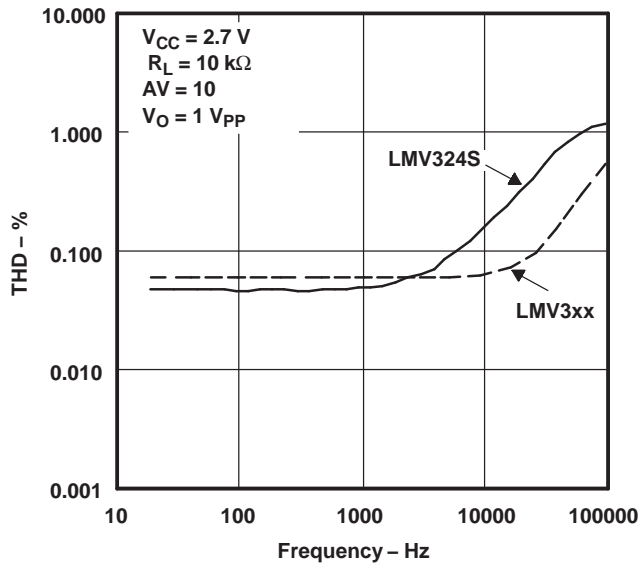

Figure 43.

THD + N
 vs
 FREQUENCY

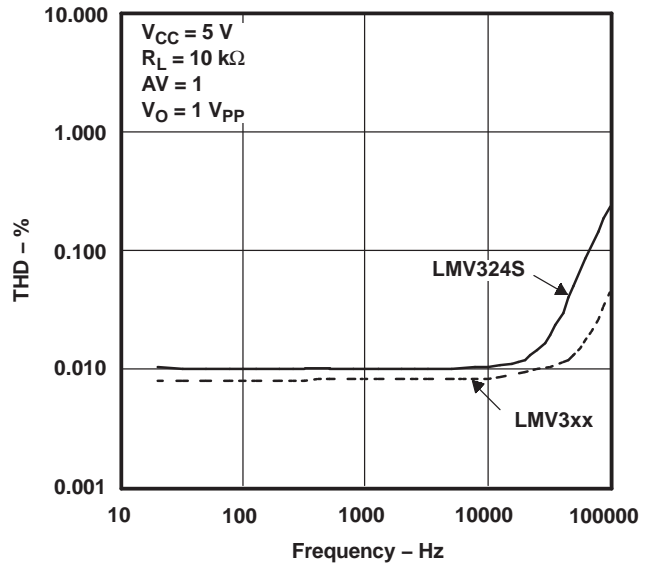

Figure 44.

TYPICAL CHARACTERISTICS (continued)

THD + N
vs
FREQUENCY

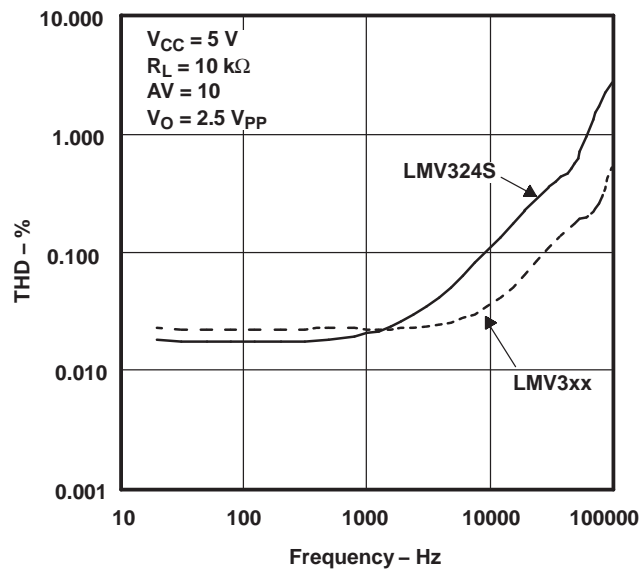

Figure 45.

REVISION HISTORY

Changes from Revision T (September 2007) to Revision U	Page
• Updated θ_{JA} value for DDU package.	4

PACKAGING INFORMATION

Orderable Device	Status (1)	Package Type	Package Drawing	Pins	Package Qty	Eco Plan (2)	Lead/Ball Finish (6)	MSL Peak Temp (3)	Op Temp (°C)	Device Marking (4/5)	Samples
LMV321IDBVR	ACTIVE	SOT-23	DBV	5	3000	Green (RoHS & no Sb/Br)	CU NIPDAU	Level-1-260C-UNLIM	-40 to 125	(RC1F ~ RC1K)	Samples
LMV321IDBVRG4	ACTIVE	SOT-23	DBV	5	3000	Green (RoHS & no Sb/Br)	CU NIPDAU	Level-1-260C-UNLIM	-40 to 125	(RC1F ~ RC1K)	Samples
LMV321IDBVT	ACTIVE	SOT-23	DBV	5	250	Green (RoHS & no Sb/Br)	CU NIPDAU	Level-1-260C-UNLIM	-40 to 125	(RC1F ~ RC1K)	Samples
LMV321IDBVT E4	ACTIVE	SOT-23	DBV	5	250	Green (RoHS & no Sb/Br)	CU NIPDAU	Level-1-260C-UNLIM	-40 to 125	(RC1F ~ RC1K)	Samples
LMV321IDBVTG4	ACTIVE	SOT-23	DBV	5	250	Green (RoHS & no Sb/Br)	CU NIPDAU	Level-1-260C-UNLIM	-40 to 125	(RC1F ~ RC1K)	Samples
LMV321IDCKR	ACTIVE	SC70	DCK	5	3000	Green (RoHS & no Sb/Br)	CU NIPDAU	Level-1-260C-UNLIM	-40 to 85	(R3C ~ R3I ~ R3O ~ R3R ~ R3Z)	Samples
LMV321IDCKRG4	ACTIVE	SC70	DCK	5	3000	Green (RoHS & no Sb/Br)	CU NIPDAU	Level-1-260C-UNLIM	-40 to 85	(R3C ~ R3I ~ R3O ~ R3R ~ R3Z)	Samples
LMV321IDCKT	ACTIVE	SC70	DCK	5	250	Green (RoHS & no Sb/Br)	CU NIPDAU	Level-1-260C-UNLIM	-40 to 85	(R3C ~ R3I ~ R3R)	Samples
LMV321IDCKTE4	ACTIVE	SC70	DCK	5	250	Green (RoHS & no Sb/Br)	CU NIPDAU	Level-1-260C-UNLIM	-40 to 85	(R3C ~ R3I ~ R3R)	Samples
LMV321IDCKTG4	ACTIVE	SC70	DCK	5	250	Green (RoHS & no Sb/Br)	CU NIPDAU	Level-1-260C-UNLIM	-40 to 85	(R3C ~ R3I ~ R3R)	Samples
LMV324ID	ACTIVE	SOIC	D	14	50	Green (RoHS & no Sb/Br)	CU NIPDAU	Level-1-260C-UNLIM	-40 to 125	LMV324I	Samples
LMV324IDG4	ACTIVE	SOIC	D	14	50	Green (RoHS & no Sb/Br)	CU NIPDAU	Level-1-260C-UNLIM	-40 to 125	LMV324I	Samples
LMV324IDR	ACTIVE	SOIC	D	14	2500	Green (RoHS & no Sb/Br)	CU NIPDAU CU SN	Level-1-260C-UNLIM	-40 to 125	LMV324I	Samples
LMV324IDRG4	ACTIVE	SOIC	D	14	2500	Green (RoHS & no Sb/Br)	CU NIPDAU	Level-1-260C-UNLIM	-40 to 125	LMV324I	Samples
LMV324IPWR	ACTIVE	TSSOP	PW	14	2000	Green (RoHS & no Sb/Br)	CU NIPDAU CU SN	Level-1-260C-UNLIM	-40 to 125	MV324I	Samples
LMV324IPWRE	ACTIVE	TSSOP	PW	14	2000	Green (RoHS & no Sb/Br)	CU NIPDAU	Level-1-260C-UNLIM	-40 to 125	MV324I	Samples
LMV324IPWRG4	ACTIVE	TSSOP	PW	14	2000	Green (RoHS & no Sb/Br)	CU NIPDAU	Level-1-260C-UNLIM	-40 to 125	MV324I	Samples

Orderable Device	Status (1)	Package Type	Package Drawing	Pins	Package Qty	Eco Plan (2)	Lead/Ball Finish (6)	MSL Peak Temp (3)	Op Temp (°C)	Device Marking (4/5)	Samples
LMV324QD	ACTIVE	SOIC	D	14	50	Green (RoHS & no Sb/Br)	CU NIPDAU	Level-1-260C-UNLIM	-40 to 125	LMV324Q	Samples
LMV324QDG4	ACTIVE	SOIC	D	14	50	Green (RoHS & no Sb/Br)	CU NIPDAU	Level-1-260C-UNLIM	-40 to 125	LMV324Q	Samples
LMV324QDR	ACTIVE	SOIC	D	14	2500	Green (RoHS & no Sb/Br)	CU NIPDAU	Level-1-260C-UNLIM	-40 to 125	LMV324Q	Samples
LMV324QDRG4	ACTIVE	SOIC	D	14	2500	Green (RoHS & no Sb/Br)	CU NIPDAU	Level-1-260C-UNLIM	-40 to 125	LMV324Q	Samples
LMV324QPW	ACTIVE	TSSOP	PW	14	90	Green (RoHS & no Sb/Br)	CU NIPDAU	Level-1-260C-UNLIM	-40 to 125	MV324Q	Samples
LMV324QPWE4	ACTIVE	TSSOP	PW	14	90	Green (RoHS & no Sb/Br)	CU NIPDAU	Level-1-260C-UNLIM	-40 to 125	MV324Q	Samples
LMV324QPWG4	ACTIVE	TSSOP	PW	14	90	Green (RoHS & no Sb/Br)	CU NIPDAU	Level-1-260C-UNLIM	-40 to 125	MV324Q	Samples
LMV324QPWR	ACTIVE	TSSOP	PW	14	2000	Green (RoHS & no Sb/Br)	CU NIPDAU	Level-1-260C-UNLIM	-40 to 125	MV324Q	Samples
LMV324QPWRG4	ACTIVE	TSSOP	PW	14	2000	Green (RoHS & no Sb/Br)	CU NIPDAU	Level-1-260C-UNLIM	-40 to 125	MV324Q	Samples
LMV324SID	OBSOLETE	SOIC	D	16		TBD	Call TI	Call TI	-40 to 85	LMV324SI	
LMV324SIDE4	OBSOLETE	SOIC	D	16		TBD	Call TI	Call TI	-40 to 85		
LMV324SIDG4	OBSOLETE	SOIC	D	16		TBD	Call TI	Call TI	-40 to 85		
LMV324SIDR	OBSOLETE	SOIC	D	16		TBD	Call TI	Call TI	-40 to 85	LMV324SI	
LMV324SIDRE4	OBSOLETE	SOIC	D	16		TBD	Call TI	Call TI	-40 to 85		
LMV324SIDRG4	OBSOLETE	SOIC	D	16		TBD	Call TI	Call TI	-40 to 85		
LMV324SIPWR	OBSOLETE	TSSOP	PW	16		TBD	Call TI	Call TI	-40 to 85	MV324SI	
LMV324SIPWRE4	OBSOLETE	TSSOP	PW	16		TBD	Call TI	Call TI	-40 to 85		
LMV324SIPWRG4	OBSOLETE	TSSOP	PW	16		TBD	Call TI	Call TI	-40 to 85		
LMV358ID	ACTIVE	SOIC	D	8	75	Green (RoHS & no Sb/Br)	CU NIPDAU	Level-1-260C-UNLIM	-40 to 125	MV358I	Samples
LMV358IDDUR	ACTIVE	VSSOP	DDU	8	3000	Green (RoHS & no Sb/Br)	CU NIPDAU	Level-1-260C-UNLIM	-40 to 125	RA5R	Samples
LMV358IDDURE4	ACTIVE	VSSOP	DDU	8	3000	Green (RoHS & no Sb/Br)	CU NIPDAU	Level-1-260C-UNLIM	-40 to 125	RA5R	Samples
LMV358IDDURG4	ACTIVE	VSSOP	DDU	8	3000	Green (RoHS & no Sb/Br)	CU NIPDAU	Level-1-260C-UNLIM	-40 to 125	RA5R	Samples

Orderable Device	Status (1)	Package Type	Package Drawing	Pins	Package Qty	Eco Plan (2)	Lead/Ball Finish (6)	MSL Peak Temp (3)	Op Temp (°C)	Device Marking (4/5)	Samples
LMV358IDE4	ACTIVE	SOIC	D	8	75	Green (RoHS & no Sb/Br)	CU NIPDAU	Level-1-260C-UNLIM	-40 to 125	MV358I	Samples
LMV358IDG4	ACTIVE	SOIC	D	8	75	Green (RoHS & no Sb/Br)	CU NIPDAU	Level-1-260C-UNLIM	-40 to 125	MV358I	Samples
LMV358IDGKR	ACTIVE	VSSOP	DGK	8	2500	Green (RoHS & no Sb/Br)	CU NIPDAU	Level-1-260C-UNLIM	-40 to 125	(R5B ~ R5Q ~ R5R)	Samples
LMV358IDGKRG4	ACTIVE	VSSOP	DGK	8	2500	Green (RoHS & no Sb/Br)	CU NIPDAU	Level-1-260C-UNLIM	-40 to 125	(R5B ~ R5Q ~ R5R)	Samples
LMV358IDR	ACTIVE	SOIC	D	8	2500	Green (RoHS & no Sb/Br)	CU NIPDAU CU SN	Level-1-260C-UNLIM	-40 to 125	MV358I	Samples
LMV358IDRE4	ACTIVE	SOIC	D	8	2500	Green (RoHS & no Sb/Br)	CU NIPDAU	Level-1-260C-UNLIM	-40 to 125	MV358I	Samples
LMV358IDRG4	ACTIVE	SOIC	D	8	2500	Green (RoHS & no Sb/Br)	CU NIPDAU	Level-1-260C-UNLIM	-40 to 125	MV358I	Samples
LMV358IPW	ACTIVE	TSSOP	PW	8	150	Green (RoHS & no Sb/Br)	CU NIPDAU	Level-1-260C-UNLIM	-40 to 125	MV358I	Samples
LMV358IPWE4	ACTIVE	TSSOP	PW	8	150	Green (RoHS & no Sb/Br)	CU NIPDAU	Level-1-260C-UNLIM	-40 to 125	MV358I	Samples
LMV358IPWG4	ACTIVE	TSSOP	PW	8	150	Green (RoHS & no Sb/Br)	CU NIPDAU	Level-1-260C-UNLIM	-40 to 125	MV358I	Samples
LMV358IPWR	ACTIVE	TSSOP	PW	8	2000	Green (RoHS & no Sb/Br)	CU NIPDAU CU SN	Level-1-260C-UNLIM	-40 to 125	MV358I	Samples
LMV358IPWRE4	ACTIVE	TSSOP	PW	8	2000	Green (RoHS & no Sb/Br)	CU NIPDAU	Level-1-260C-UNLIM	-40 to 125	MV358I	Samples
LMV358IPWRG4	ACTIVE	TSSOP	PW	8	2000	Green (RoHS & no Sb/Br)	CU NIPDAU	Level-1-260C-UNLIM	-40 to 125	MV358I	Samples
LMV358QD	ACTIVE	SOIC	D	8	75	Green (RoHS & no Sb/Br)	CU NIPDAU	Level-1-260C-UNLIM	-40 to 125	MV358Q	Samples
LMV358QDDUR	ACTIVE	VSSOP	DDU	8	3000	Green (RoHS & no Sb/Br)	CU NIPDAU	Level-1-260C-UNLIM	-40 to 125	RAHR	Samples
LMV358QDDURE4	ACTIVE	VSSOP	DDU	8	3000	Green (RoHS & no Sb/Br)	CU NIPDAU	Level-1-260C-UNLIM	-40 to 125	RAHR	Samples
LMV358QDDURG4	ACTIVE	VSSOP	DDU	8	3000	Green (RoHS & no Sb/Br)	CU NIPDAU	Level-1-260C-UNLIM	-40 to 125	RAHR	Samples
LMV358QDE4	ACTIVE	SOIC	D	8	75	Green (RoHS & no Sb/Br)	CU NIPDAU	Level-1-260C-UNLIM	-40 to 125	MV358Q	Samples

Orderable Device	Status (1)	Package Type	Package Drawing	Pins	Package Qty	Eco Plan (2)	Lead/Ball Finish (6)	MSL Peak Temp (3)	Op Temp (°C)	Device Marking (4/5)	Samples
LMV358QDG4	ACTIVE	SOIC	D	8	75	Green (RoHS & no Sb/Br)	CU NIPDAU	Level-1-260C-UNLIM	-40 to 125	MV358Q	Samples
LMV358QDGKR	ACTIVE	VSSOP	DGK	8	2500	Green (RoHS & no Sb/Br)	CU NIPDAU	Level-1-260C-UNLIM	-40 to 125	(RHO ~ RHR)	Samples
LMV358QDGKRG4	ACTIVE	VSSOP	DGK	8	2500	Green (RoHS & no Sb/Br)	CU NIPDAU	Level-1-260C-UNLIM	-40 to 125	(RHO ~ RHR)	Samples
LMV358QDR	ACTIVE	SOIC	D	8	2500	Green (RoHS & no Sb/Br)	CU NIPDAU	Level-1-260C-UNLIM	-40 to 125	MV358Q	Samples
LMV358QDRE4	ACTIVE	SOIC	D	8	2500	Green (RoHS & no Sb/Br)	CU NIPDAU	Level-1-260C-UNLIM	-40 to 125	MV358Q	Samples
LMV358QDRG4	ACTIVE	SOIC	D	8	2500	Green (RoHS & no Sb/Br)	CU NIPDAU	Level-1-260C-UNLIM	-40 to 125	MV358Q	Samples
LMV358QPWR	ACTIVE	TSSOP	PW	8	2000	Green (RoHS & no Sb/Br)	CU NIPDAU	Level-1-260C-UNLIM	-40 to 125	MV358Q	Samples
LMV358QPWRE4	ACTIVE	TSSOP	PW	8	2000	Green (RoHS & no Sb/Br)	CU NIPDAU	Level-1-260C-UNLIM	-40 to 125	MV358Q	Samples
LMV358QPWRG4	ACTIVE	TSSOP	PW	8	2000	Green (RoHS & no Sb/Br)	CU NIPDAU	Level-1-260C-UNLIM	-40 to 125	MV358Q	Samples

(1) The marketing status values are defined as follows:

ACTIVE: Product device recommended for new designs.

LIFEBUY: TI has announced that the device will be discontinued, and a lifetime-buy period is in effect.

NRND: Not recommended for new designs. Device is in production to support existing customers, but TI does not recommend using this part in a new design.

PREVIEW: Device has been announced but is not in production. Samples may or may not be available.

OBSELETE: TI has discontinued the production of the device.

(2) Eco Plan - The planned eco-friendly classification: Pb-Free (RoHS), Pb-Free (RoHS Exempt), or Green (RoHS & no Sb/Br) - please check <http://www.ti.com/productcontent> for the latest availability information and additional product content details.

TBD: The Pb-Free/Green conversion plan has not been defined.

Pb-Free (RoHS): TI's terms "Lead-Free" or "Pb-Free" mean semiconductor products that are compatible with the current RoHS requirements for all 6 substances, including the requirement that lead not exceed 0.1% by weight in homogeneous materials. Where designed to be soldered at high temperatures, TI Pb-Free products are suitable for use in specified lead-free processes.

Pb-Free (RoHS Exempt): This component has a RoHS exemption for either 1) lead-based flip-chip solder bumps used between the die and package, or 2) lead-based die adhesive used between the die and leadframe. The component is otherwise considered Pb-Free (RoHS compatible) as defined above.

Green (RoHS & no Sb/Br): TI defines "Green" to mean Pb-Free (RoHS compatible), and free of Bromine (Br) and Antimony (Sb) based flame retardants (Br or Sb do not exceed 0.1% by weight in homogeneous material)

(3) MSL, Peak Temp. - The Moisture Sensitivity Level rating according to the JEDEC industry standard classifications, and peak solder temperature.

(4) There may be additional marking, which relates to the logo, the lot trace code information, or the environmental category on the device.

(5) Multiple Device Markings will be inside parentheses. Only one Device Marking contained in parentheses and separated by a "~" will appear on a device. If a line is indented then it is a continuation of the previous line and the two combined represent the entire Device Marking for that device.

(6) Lead/Ball Finish - Orderable Devices may have multiple material finish options. Finish options are separated by a vertical ruled line. Lead/Ball Finish values may wrap to two lines if the finish value exceeds the maximum column width.

Important Information and Disclaimer:The information provided on this page represents TI's knowledge and belief as of the date that it is provided. TI bases its knowledge and belief on information provided by third parties, and makes no representation or warranty as to the accuracy of such information. Efforts are underway to better integrate information from third parties. TI has taken and continues to take reasonable steps to provide representative and accurate information but may not have conducted destructive testing or chemical analysis on incoming materials and chemicals. TI and TI suppliers consider certain information to be proprietary, and thus CAS numbers and other limited information may not be available for release.

In no event shall TI's liability arising out of such information exceed the total purchase price of the TI part(s) at issue in this document sold by TI to Customer on an annual basis.

OTHER QUALIFIED VERSIONS OF LMV324, LMV358 :

- Automotive: [LMV324-Q1](#), [LMV358-Q1](#)

NOTE: Qualified Version Definitions:

- Automotive - Q100 devices qualified for high-reliability automotive applications targeting zero defects

TAPE AND REEL INFORMATION

QUADRANT ASSIGNMENTS FOR PIN 1 ORIENTATION IN TAPE

*All dimensions are nominal

Device	Package Type	Package Drawing	Pins	SPQ	Reel Diameter (mm)	Reel Width W1 (mm)	A0 (mm)	B0 (mm)	K0 (mm)	P1 (mm)	W (mm)	Pin1 Quadrant
LMV321IDBVR	SOT-23	DBV	5	3000	180.0	9.2	3.17	3.23	1.37	4.0	8.0	Q3
LMV321IDBVR	SOT-23	DBV	5	3000	178.0	9.0	3.23	3.17	1.37	4.0	8.0	Q3
LMV321IDBVT	SOT-23	DBV	5	250	180.0	9.2	3.17	3.23	1.37	4.0	8.0	Q3
LMV321IDBVT	SOT-23	DBV	5	250	178.0	9.0	3.23	3.17	1.37	4.0	8.0	Q3
LMV321IDCKR	SC70	DCK	5	3000	180.0	9.2	2.3	2.55	1.2	4.0	8.0	Q3
LMV321IDCKR	SC70	DCK	5	3000	178.0	9.0	2.4	2.5	1.2	4.0	8.0	Q3
LMV321IDCKT	SC70	DCK	5	250	180.0	9.2	2.3	2.55	1.2	4.0	8.0	Q3
LMV321IDCKT	SC70	DCK	5	250	178.0	9.0	2.4	2.5	1.2	4.0	8.0	Q3
LMV324IDR	SOIC	D	14	2500	330.0	16.4	6.5	9.0	2.1	8.0	16.0	Q1
LMV324IDR	SOIC	D	14	2500	330.0	16.8	6.5	9.5	2.3	8.0	16.0	Q1
LMV324IDRG4	SOIC	D	14	2500	330.0	16.4	6.5	9.0	2.1	8.0	16.0	Q1
LMV324IPWR	TSSOP	PW	14	2000	330.0	12.4	7.0	5.6	1.6	8.0	12.0	Q1
LMV324IPWRG4	TSSOP	PW	14	2000	330.0	12.4	6.9	5.6	1.6	8.0	12.0	Q1
LMV324QDR	SOIC	D	14	2500	330.0	16.4	6.5	9.0	2.1	8.0	16.0	Q1
LMV324QPWR	TSSOP	PW	14	2000	330.0	12.4	6.9	5.6	1.6	8.0	12.0	Q1
LMV358IDDUR	VSSOP	DDU	8	3000	180.0	8.4	2.25	3.35	1.05	4.0	8.0	Q3
LMV358IDGKR	VSSOP	DGK	8	2500	330.0	12.4	5.3	3.4	1.4	8.0	12.0	Q1
LMV358IDR	SOIC	D	8	2500	330.0	12.8	6.4	5.2	2.1	8.0	12.0	Q1

Device	Package Type	Package Drawing	Pins	SPQ	Reel Diameter (mm)	Reel Width W1 (mm)	A0 (mm)	B0 (mm)	K0 (mm)	P1 (mm)	W (mm)	Pin1 Quadrant
LMV358IDR	SOIC	D	8	2500	330.0	12.4	6.4	5.2	2.1	8.0	12.0	Q1
LMV358IDR	SOIC	D	8	2500	330.0	12.4	6.4	5.2	2.1	8.0	12.0	Q1
LMV358IDRG4	SOIC	D	8	2500	330.0	12.4	6.4	5.2	2.1	8.0	12.0	Q1
LMV358IDRG4	SOIC	D	8	2500	330.0	12.4	6.4	5.2	2.1	8.0	12.0	Q1
LMV358IPWR	TSSOP	PW	8	2000	330.0	12.4	7.0	3.6	1.6	8.0	12.0	Q1
LMV358QDDUR	VSSOP	DDU	8	3000	180.0	8.4	2.25	3.35	1.05	4.0	8.0	Q3
LMV358QDGKR	VSSOP	DGK	8	2500	330.0	12.4	5.3	3.4	1.4	8.0	12.0	Q1
LMV358QDR	SOIC	D	8	2500	330.0	12.4	6.4	5.2	2.1	8.0	12.0	Q1

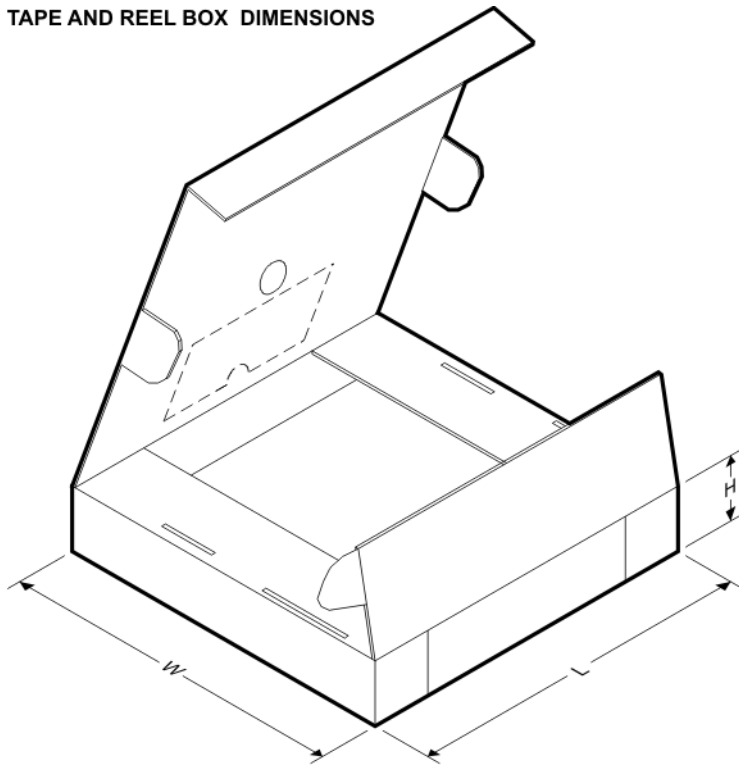
TAPE AND REEL BOX DIMENSIONS

*All dimensions are nominal

Device	Package Type	Package Drawing	Pins	SPQ	Length (mm)	Width (mm)	Height (mm)
LMV321IDBVR	SOT-23	DBV	5	3000	205.0	200.0	33.0
LMV321IDBVR	SOT-23	DBV	5	3000	180.0	180.0	18.0
LMV321IDBVT	SOT-23	DBV	5	250	205.0	200.0	33.0
LMV321IDBVT	SOT-23	DBV	5	250	180.0	180.0	18.0
LMV321IDCKR	SC70	DCK	5	3000	205.0	200.0	33.0
LMV321IDCKR	SC70	DCK	5	3000	180.0	180.0	18.0
LMV321IDCKT	SC70	DCK	5	250	205.0	200.0	33.0
LMV321IDCKT	SC70	DCK	5	250	180.0	180.0	18.0
LMV324IDR	SOIC	D	14	2500	333.2	345.9	28.6

Device	Package Type	Package Drawing	Pins	SPQ	Length (mm)	Width (mm)	Height (mm)
LMV324IDR	SOIC	D	14	2500	364.0	364.0	27.0
LMV324IDRG4	SOIC	D	14	2500	333.2	345.9	28.6
LMV324IPWR	TSSOP	PW	14	2000	364.0	364.0	27.0
LMV324IPWRG4	TSSOP	PW	14	2000	367.0	367.0	35.0
LMV324QDR	SOIC	D	14	2500	367.0	367.0	38.0
LMV324QPWR	TSSOP	PW	14	2000	367.0	367.0	35.0
LMV358IDDUR	VSSOP	DDU	8	3000	202.0	201.0	28.0
LMV358IDGKR	VSSOP	DGK	8	2500	358.0	335.0	35.0
LMV358IDR	SOIC	D	8	2500	364.0	364.0	27.0
LMV358IDR	SOIC	D	8	2500	367.0	367.0	35.0
LMV358IDR	SOIC	D	8	2500	340.5	338.1	20.6
LMV358IDRG4	SOIC	D	8	2500	340.5	338.1	20.6
LMV358IDRG4	SOIC	D	8	2500	367.0	367.0	35.0
LMV358IPWR	TSSOP	PW	8	2000	364.0	364.0	27.0
LMV358QDDUR	VSSOP	DDU	8	3000	202.0	201.0	28.0
LMV358QDGKR	VSSOP	DGK	8	2500	358.0	335.0	35.0
LMV358QDR	SOIC	D	8	2500	340.5	338.1	20.6

MECHANICAL DATA

DBV (R-PDSO-G5)

PLASTIC SMALL-OUTLINE PACKAGE

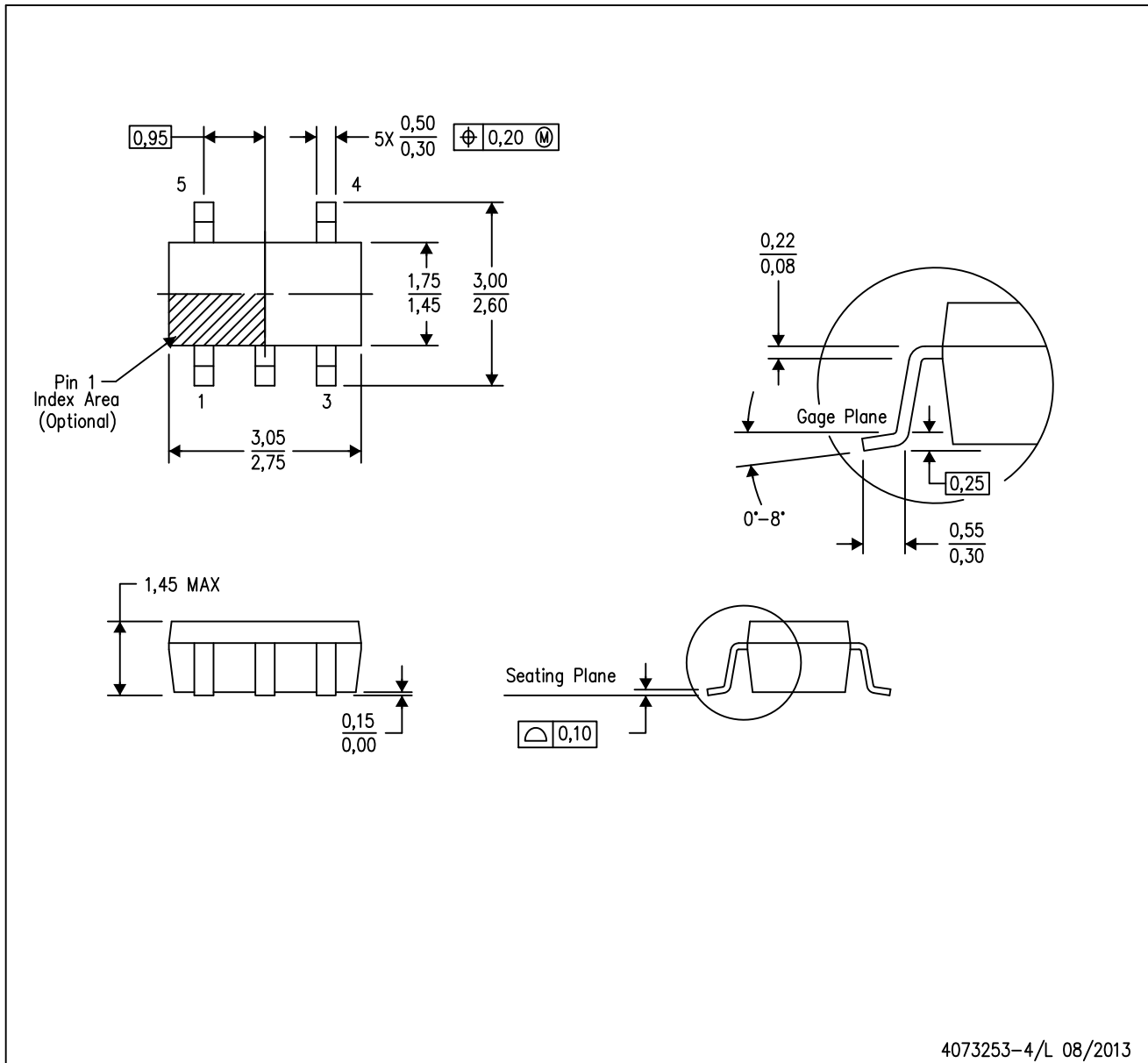

- NOTES:
- A. All linear dimensions are in millimeters.
 - B. This drawing is subject to change without notice.
 - C. Body dimensions do not include mold flash or protrusion. Mold flash and protrusion shall not exceed 0.15 per side.
 - D. Falls within JEDEC MO-178 Variation AA.

DBV (R-PDSO-G5)

PLASTIC SMALL OUTLINE



- NOTES:
- A. All linear dimensions are in millimeters.
 - B. This drawing is subject to change without notice.
 - C. Customers should place a note on the circuit board fabrication drawing not to alter the center solder mask defined pad.
 - D. Publication IPC-7351 is recommended for alternate designs.
 - E. Laser cutting apertures with trapezoidal walls and also rounding corners will offer better paste release. Customers should contact their board assembly site for stencil design recommendations. Example stencil design based on a 50% volumetric metal load solder paste. Refer to IPC-7525 for other stencil recommendations.

DCK (R-PDSO-G5)

PLASTIC SMALL-OUTLINE PACKAGE



- NOTES:
- A. All linear dimensions are in millimeters.
 - B. This drawing is subject to change without notice.
 - C. Body dimensions do not include mold flash or protrusion. Mold flash and protrusion shall not exceed 0.15 per side.
 - D. Falls within JEDEC MO-203 variation AA.

DCK (R-PDSO-G5)

PLASTIC SMALL OUTLINE



- NOTES:
- All linear dimensions are in millimeters.
 - This drawing is subject to change without notice.
 - Customers should place a note on the circuit board fabrication drawing not to alter the center solder mask defined pad.
 - Publication IPC-7351 is recommended for alternate designs.
 - Laser cutting apertures with trapezoidal walls and also rounding corners will offer better paste release. Customers should contact their board assembly site for stencil design recommendations. Example stencil design based on a 50% volumetric metal load solder paste. Refer to IPC-7525 for other stencil recommendations.

DGK (S-PDSO-G8)

PLASTIC SMALL-OUTLINE PACKAGE

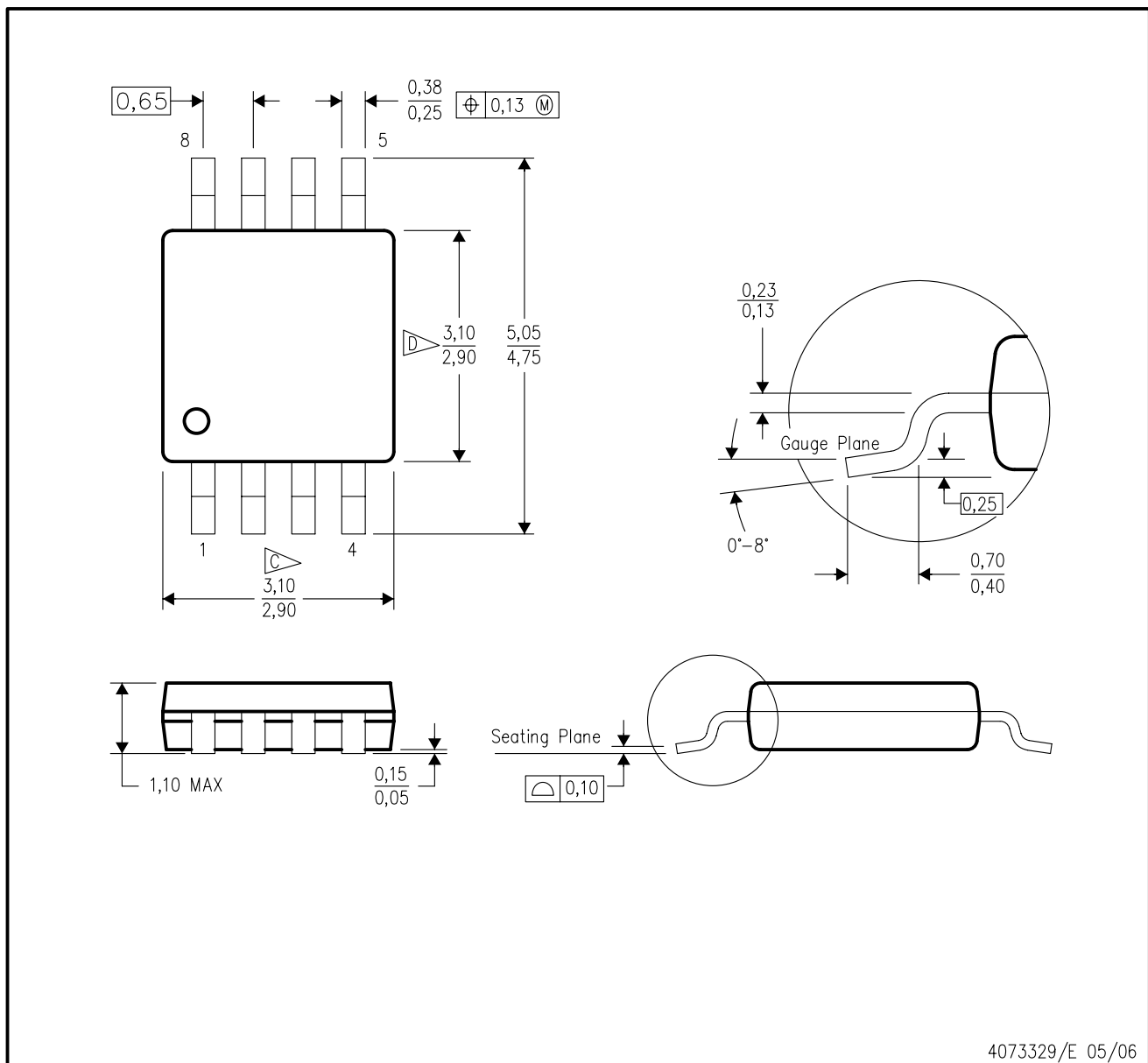

- NOTES:
- A. All linear dimensions are in millimeters.
 - B. This drawing is subject to change without notice.
 - C. Body length does not include mold flash, protrusions, or gate burrs. Mold flash, protrusions, or gate burrs shall not exceed 0.15 per end.
 - D. Body width does not include interlead flash. Interlead flash shall not exceed 0.50 per side.
 - E. Falls within JEDEC MO-187 variation AA, except interlead flash.

DDU (R-PDSO-G8)

PLASTIC SMALL-OUTLINE PACKAGE

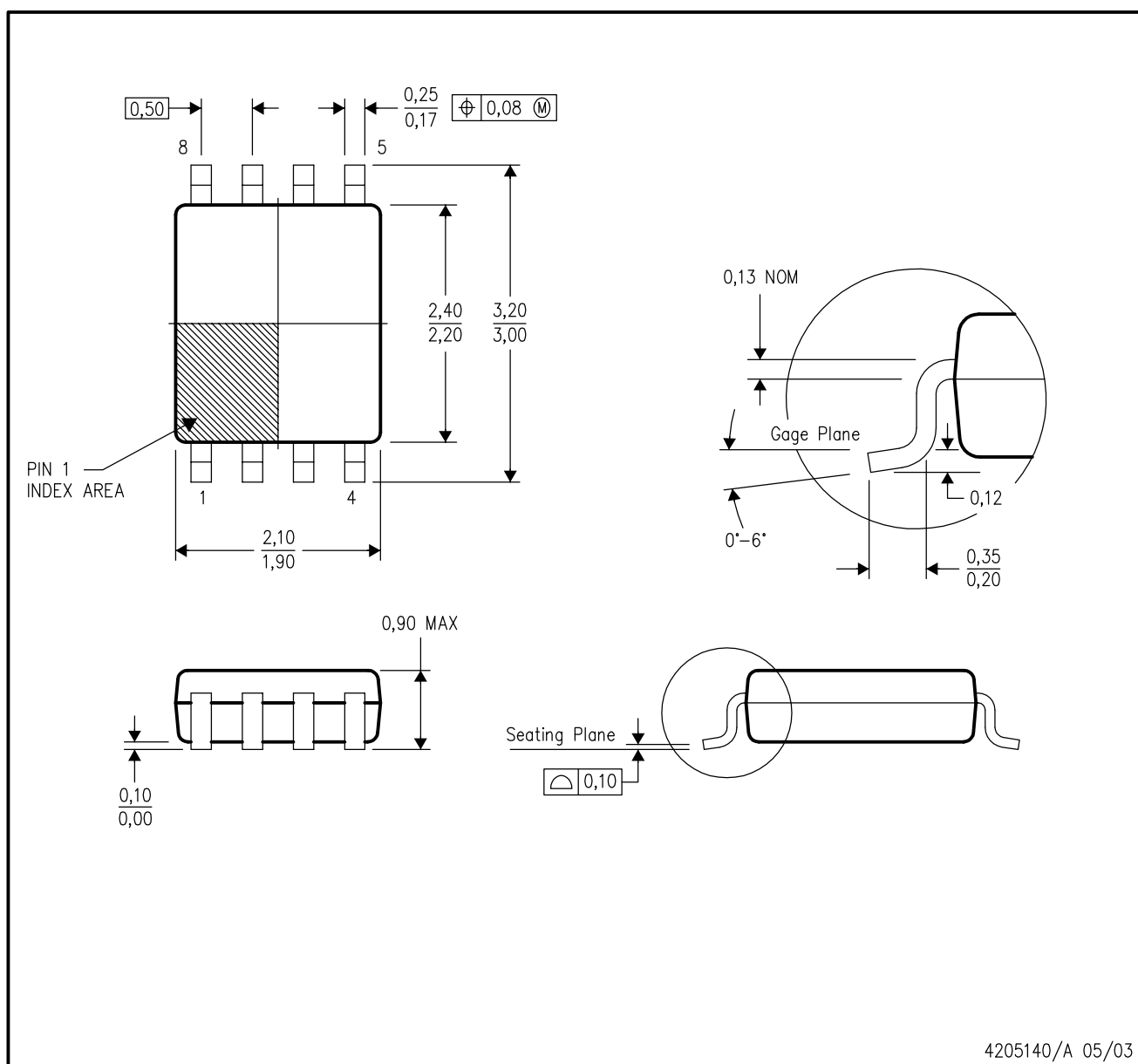

- NOTES:
- All linear dimensions are in millimeters.
 - This drawing is subject to change without notice.
 - Body dimensions do not include mold flash or protrusion.
 - Falls within JEDEC MO-187 variation CA.

DDU (S-PDSO-G8)

PLASTIC SMALL OUTLINE PACKAGE (DIE UP)

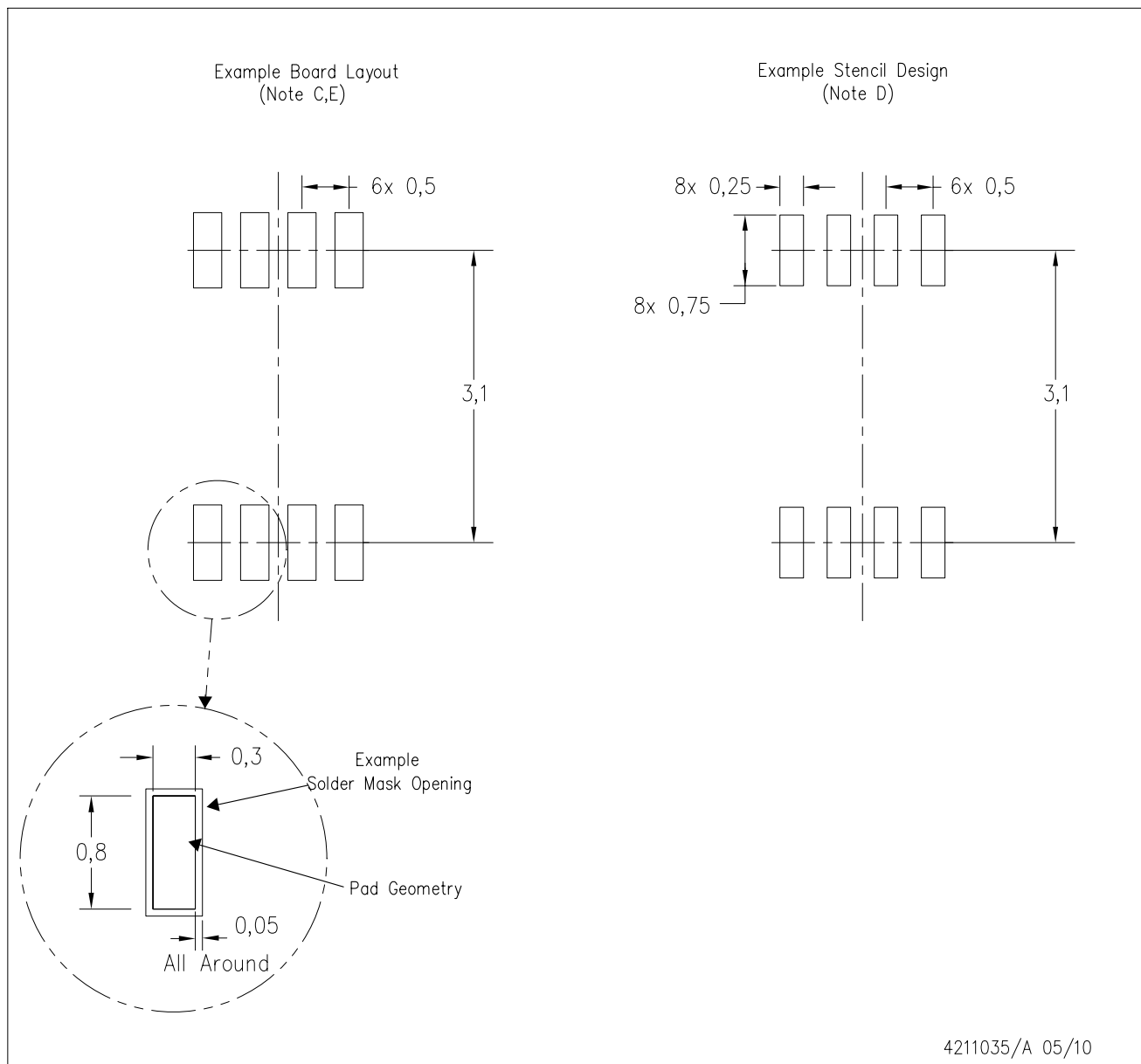

- NOTES:
- All linear dimensions are in millimeters.
 - This drawing is subject to change without notice.
 - Publication IPC-7351 is recommended for alternate designs.
 - Laser cutting apertures with trapezoidal walls and also rounding corners will offer better paste release. Customers should contact their board assembly site for stencil design recommendations. Refer to IPC-7525.
 - Customers should contact their board fabrication site for solder mask tolerances between and around signal pads.

D (R-PDSO-G14)

PLASTIC SMALL OUTLINE



- NOTES:
- A. All linear dimensions are in inches (millimeters).
 - B. This drawing is subject to change without notice.
 - $\triangle C$ Body length does not include mold flash, protrusions, or gate burrs. Mold flash, protrusions, or gate burrs shall not exceed 0.006 (0,15) each side.
 - $\triangle D$ Body width does not include interlead flash. Interlead flash shall not exceed 0.017 (0,43) each side.
 - E. Reference JEDEC MS-012 variation AB.

D (R-PDSO-G14)

PLASTIC SMALL OUTLINE



4211283-3/E 08/12

- NOTES:
- All linear dimensions are in millimeters.
 - This drawing is subject to change without notice.
 - Publication IPC-7351 is recommended for alternate designs.
 - Laser cutting apertures with trapezoidal walls and also rounding corners will offer better paste release. Customers should contact their board assembly site for stencil design recommendations. Refer to IPC-7525 for other stencil recommendations.
 - Customers should contact their board fabrication site for solder mask tolerances between and around signal pads.

D (R-PDSO-G16)

PLASTIC SMALL OUTLINE



4040047-6/M 06/11

- NOTES:
- A. All linear dimensions are in inches (millimeters).
 - B. This drawing is subject to change without notice.
 -  Body length does not include mold flash, protrusions, or gate burrs. Mold flash, protrusions, or gate burrs shall not exceed 0.006 (0,15) each side.
 -  Body width does not include interlead flash. Interlead flash shall not exceed 0.017 (0,43) each side.
 - E. Reference JEDEC MS-012 variation AC.

MECHANICAL DATA

PW (R-PDSO-G14)

PLASTIC SMALL OUTLINE

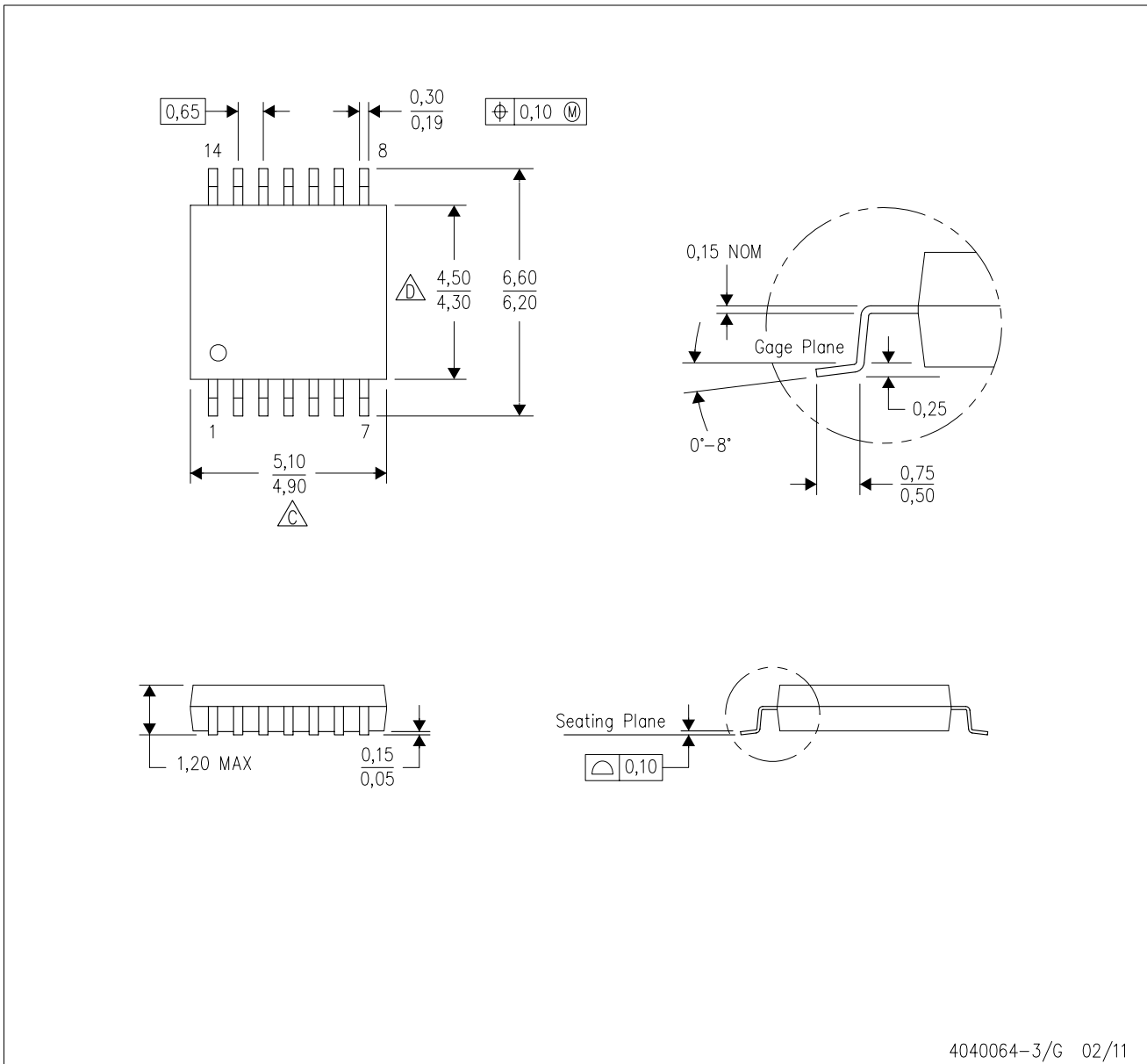

- NOTES:
- A. All linear dimensions are in millimeters. Dimensioning and tolerancing per ASME Y14.5M-1994.
 - B. This drawing is subject to change without notice.
 - C. Body length does not include mold flash, protrusions, or gate burrs. Mold flash, protrusions, or gate burrs shall not exceed 0,15 each side.
 - D. Body width does not include interlead flash. Interlead flash shall not exceed 0,25 each side.
 - E. Falls within JEDEC MO-153

PW (R-PDSO-G14)

PLASTIC SMALL OUTLINE

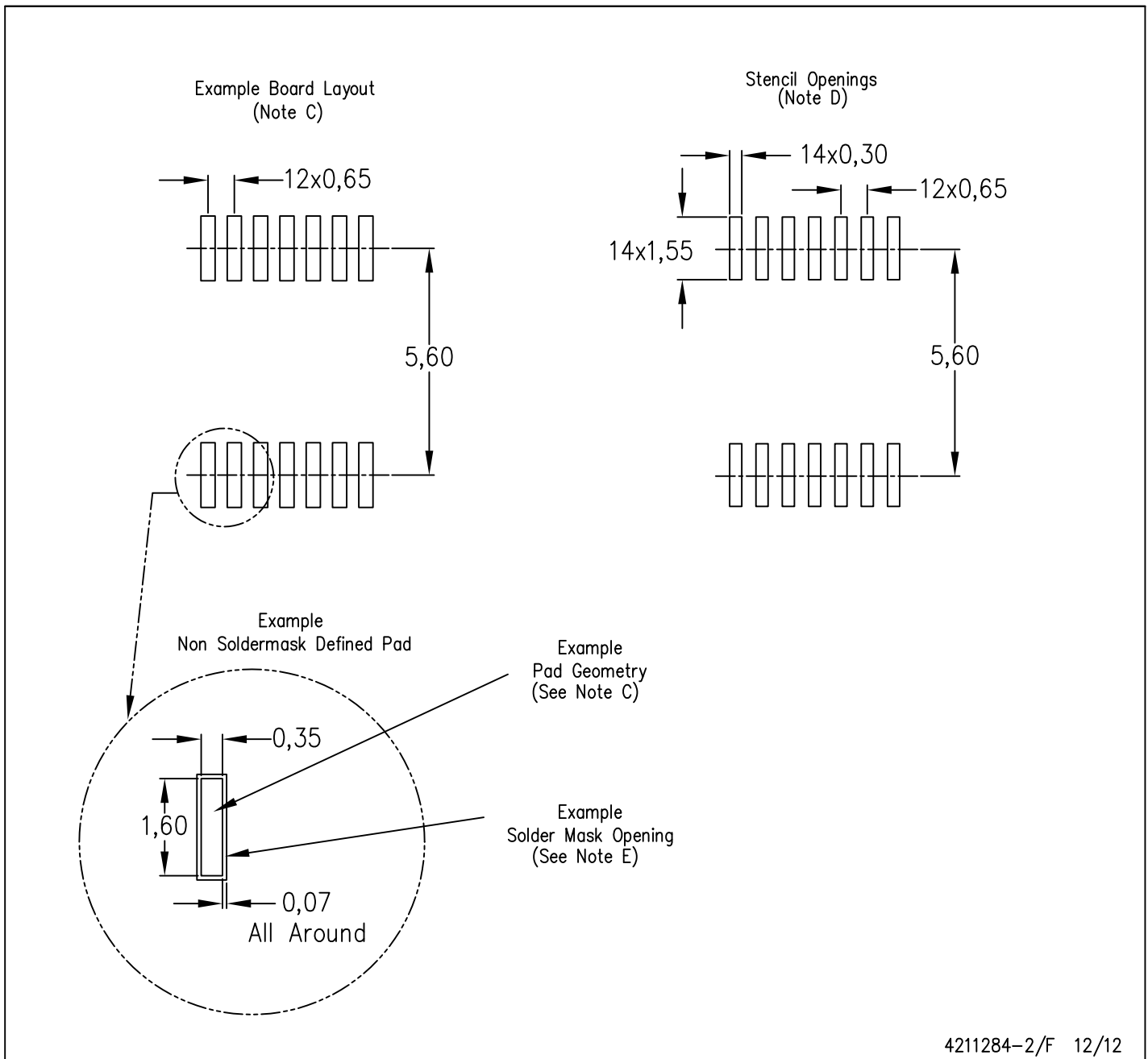

- NOTES:
- All linear dimensions are in millimeters.
 - This drawing is subject to change without notice.
 - Publication IPC-7351 is recommended for alternate designs.
 - Laser cutting apertures with trapezoidal walls and also rounding corners will offer better paste release. Customers should contact their board assembly site for stencil design recommendations. Refer to IPC-7525 for other stencil recommendations.
 - Customers should contact their board fabrication site for solder mask tolerances between and around signal pads.

PW (R-PDSO-G16)

PLASTIC SMALL OUTLINE



- NOTES:
- A. All linear dimensions are in millimeters. Dimensioning and tolerancing per ASME Y14.5M-1994.
 - B. This drawing is subject to change without notice.
 - C. Body length does not include mold flash, protrusions, or gate burrs. Mold flash, protrusions, or gate burrs shall not exceed 0,15 each side.
 - D. Body width does not include interlead flash. Interlead flash shall not exceed 0,25 each side.
 - E. Falls within JEDEC MO-153

D (R-PDSO-G8)

PLASTIC SMALL OUTLINE



- NOTES:
- A. All linear dimensions are in inches (millimeters).
 - B. This drawing is subject to change without notice.
 - C. Body length does not include mold flash, protrusions, or gate burrs. Mold flash, protrusions, or gate burrs shall not exceed 0.006 (0,15) each side.
 - D. Body width does not include interlead flash. Interlead flash shall not exceed 0.017 (0,43) each side.
 - E. Reference JEDEC MS-012 variation AA.

D (R-PDSO-G8)

PLASTIC SMALL OUTLINE



- NOTES:
- A. All linear dimensions are in millimeters.
 - B. This drawing is subject to change without notice.
 - C. Publication IPC-7351 is recommended for alternate designs.
 - D. Laser cutting apertures with trapezoidal walls and also rounding corners will offer better paste release. Customers should contact their board assembly site for stencil design recommendations. Refer to IPC-7525 for other stencil recommendations.
 - E. Customers should contact their board fabrication site for solder mask tolerances between and around signal pads.

PW (R-PDSO-G8)

PLASTIC SMALL OUTLINE

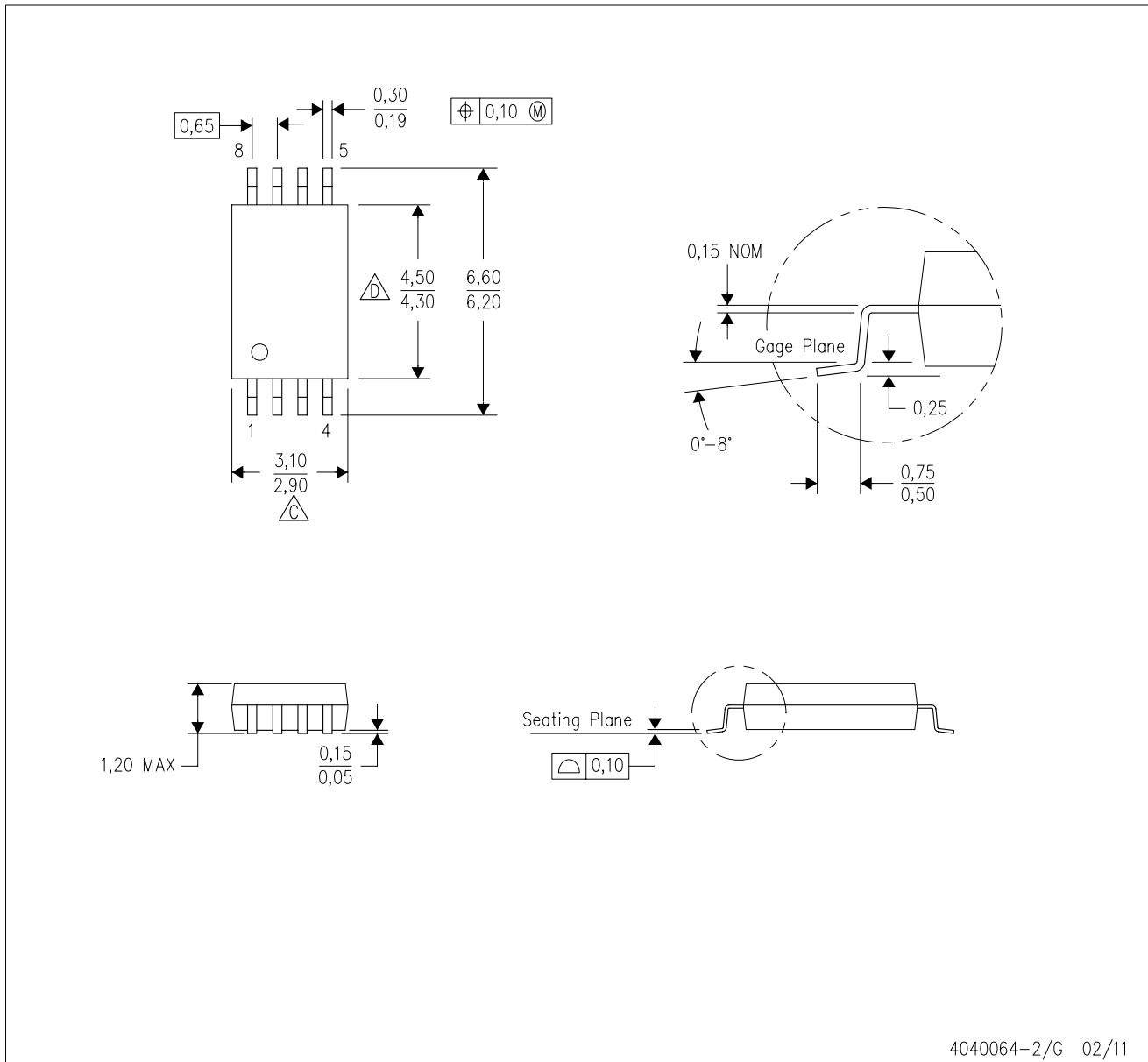

- NOTES:
- A. All linear dimensions are in millimeters. Dimensioning and tolerancing per ASME Y14.5M-1994.
 - B. This drawing is subject to change without notice.
 - C. Body length does not include mold flash, protrusions, or gate burrs. Mold flash, protrusions, or gate burrs shall not exceed 0,15 each side.
 - D. Body width does not include interlead flash. Interlead flash shall not exceed 0,25 each side.
 - E. Falls within JEDEC MO-153

IMPORTANT NOTICE

Texas Instruments Incorporated and its subsidiaries (TI) reserve the right to make corrections, enhancements, improvements and other changes to its semiconductor products and services per JESD46, latest issue, and to discontinue any product or service per JESD48, latest issue. Buyers should obtain the latest relevant information before placing orders and should verify that such information is current and complete. All semiconductor products (also referred to herein as "components") are sold subject to TI's terms and conditions of sale supplied at the time of order acknowledgment.

TI warrants performance of its components to the specifications applicable at the time of sale, in accordance with the warranty in TI's terms and conditions of sale of semiconductor products. Testing and other quality control techniques are used to the extent TI deems necessary to support this warranty. Except where mandated by applicable law, testing of all parameters of each component is not necessarily performed.

TI assumes no liability for applications assistance or the design of Buyers' products. Buyers are responsible for their products and applications using TI components. To minimize the risks associated with Buyers' products and applications, Buyers should provide adequate design and operating safeguards.

TI does not warrant or represent that any license, either express or implied, is granted under any patent right, copyright, mask work right, or other intellectual property right relating to any combination, machine, or process in which TI components or services are used. Information published by TI regarding third-party products or services does not constitute a license to use such products or services or a warranty or endorsement thereof. Use of such information may require a license from a third party under the patents or other intellectual property of the third party, or a license from TI under the patents or other intellectual property of TI.

Reproduction of significant portions of TI information in TI data books or data sheets is permissible only if reproduction is without alteration and is accompanied by all associated warranties, conditions, limitations, and notices. TI is not responsible or liable for such altered documentation. Information of third parties may be subject to additional restrictions.

Resale of TI components or services with statements different from or beyond the parameters stated by TI for that component or service voids all express and any implied warranties for the associated TI component or service and is an unfair and deceptive business practice. TI is not responsible or liable for any such statements.

Buyer acknowledges and agrees that it is solely responsible for compliance with all legal, regulatory and safety-related requirements concerning its products, and any use of TI components in its applications, notwithstanding any applications-related information or support that may be provided by TI. Buyer represents and agrees that it has all the necessary expertise to create and implement safeguards which anticipate dangerous consequences of failures, monitor failures and their consequences, lessen the likelihood of failures that might cause harm and take appropriate remedial actions. Buyer will fully indemnify TI and its representatives against any damages arising out of the use of any TI components in safety-critical applications.

In some cases, TI components may be promoted specifically to facilitate safety-related applications. With such components, TI's goal is to help enable customers to design and create their own end-product solutions that meet applicable functional safety standards and requirements. Nonetheless, such components are subject to these terms.

No TI components are authorized for use in FDA Class III (or similar life-critical medical equipment) unless authorized officers of the parties have executed a special agreement specifically governing such use.

Only those TI components which TI has specifically designated as military grade or "enhanced plastic" are designed and intended for use in military/aerospace applications or environments. Buyer acknowledges and agrees that any military or aerospace use of TI components which have **not** been so designated is solely at the Buyer's risk, and that Buyer is solely responsible for compliance with all legal and regulatory requirements in connection with such use.

TI has specifically designated certain components as meeting ISO/TS16949 requirements, mainly for automotive use. In any case of use of non-designated products, TI will not be responsible for any failure to meet ISO/TS16949.

Products

Audio	www.ti.com/audio
Amplifiers	amplifier.ti.com
Data Converters	dataconverter.ti.com
DLP® Products	www.dlp.com
DSP	dsp.ti.com
Clocks and Timers	www.ti.com/clocks
Interface	interface.ti.com
Logic	logic.ti.com
Power Mgmt	power.ti.com
Microcontrollers	microcontroller.ti.com
RFID	www.ti-rfid.com
OMAP Applications Processors	www.ti.com/omap
Wireless Connectivity	www.ti.com/wirelessconnectivity

Applications

Automotive and Transportation	www.ti.com/automotive
Communications and Telecom	www.ti.com/communications
Computers and Peripherals	www.ti.com/computers
Consumer Electronics	www.ti.com/consumer-apps
Energy and Lighting	www.ti.com/energy
Industrial	www.ti.com/industrial
Medical	www.ti.com/medical
Security	www.ti.com/security
Space, Avionics and Defense	www.ti.com/space-avionics-defense
Video and Imaging	www.ti.com/video

TI E2E Community

e2e.ti.com