

WLS28 Work Light Strip



Datasheet

General-purpose LED work lighting for IP50 and IP67/IP69K environments

To view or download the latest technical information about this product, including specifications, dimensions, accessories, and wiring, see <http://www.bannerengineering.com>.

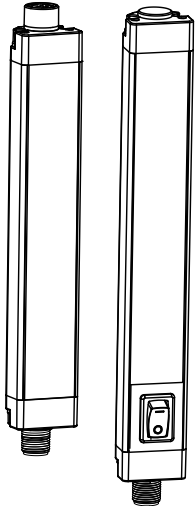

- High power solid state LED array
- Designed for enclosure or area lighting
- Rugged aluminum housing
- Narrow 28 mm total width
- Lighted lengths available from 145 mm to 1130 mm
- Low-profile design with included swivel mounting brackets
- Illuminates a large area with an even pattern of light and no shadows
- 12 to 30V dc operation
- Cabled and Quick Disconnect models available
- Stand-alone and cascadable models available
- IP50 and IP67/IP69K models available
- IP50 models available with or without ON/OFF switch
- Low power consumption; less than 9 watts per foot
- Lensed model - provides 2X the illumination focused to where it is needed



NOTE: When cascading lights, a model with an ON/OFF switch can be used to control the lights cascaded off of the switched model.

Work Light Strip Models

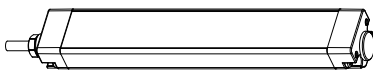

Stand-Alone Light—cable

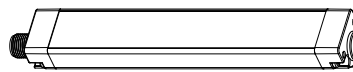

Stand-Alone Light or End Light in a Cascade—QD

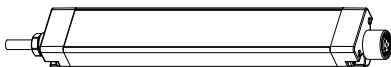

First Light in a Cascade—cable

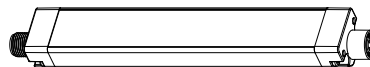

First or Middle of a Cascade—QD

WLS28 Work Light Strips are available as either stand-alone models, or as cascade models that can be "daisy-chained" together for a continuous length of lighting, with a minimum of wiring.

Stand-alone models have cable or male QD fitting at one end for power connection, no connections at opposite end. A stand-alone model may be used as the last in the cascade series.

Cascade models have cable or male QD fitting at one end for power connection, female QD fitting at opposite end for connection to other lights in the cascade. Cascade models with cable end can only be used as the first light in the cascade series. A double-ended accessory cordset (see [Cordsets](#) on page 4) must be used between each pair of lights in a cascade.



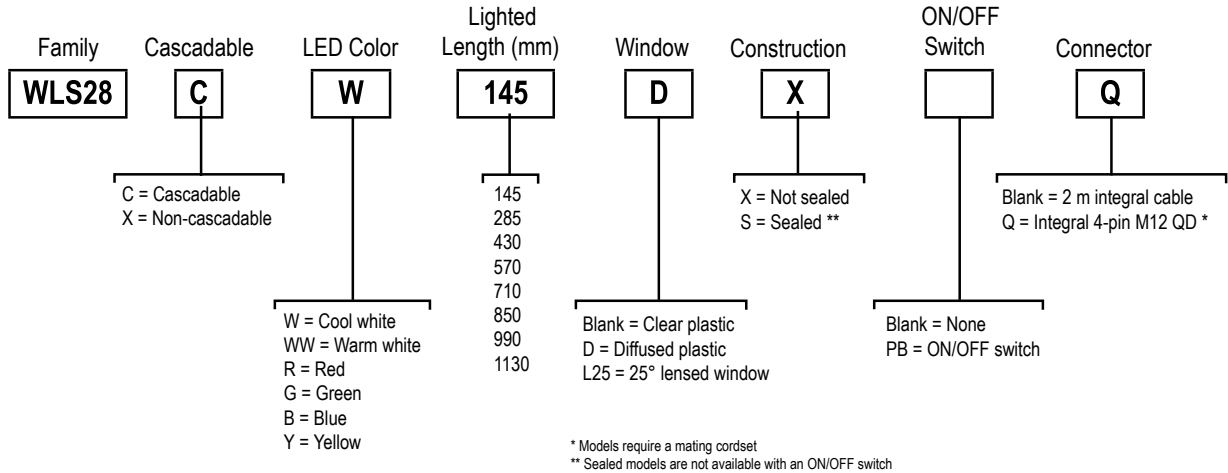

Table 1: IP50 Models

Non-Switch Models		ON/OFF Switch Models		Lighted Length	Power Connector ¹
Stand-Alone	Cascade	Stand-Alone	Cascade		
WLS28XW145X	WLS28CW145X	WLS28XW145XPB	WLS28CW145XPB	145 mm	2 m cable
WLS28XW285X	WLS28CW285X	WLS28XW285XPB	WLS28CW285XPB	285 mm	
WLS28XW430X	WLS28CW430X	WLS28XW430XPB	WLS28CW430XPB	430 mm	
WLS28XW570X	WLS28CW570X	WLS28XW570XPB	WLS28CW570XPB	570 mm	
WLS28XW710X	WLS28CW710X	WLS28XW710XPB	WLS28CW710XPB	710 mm	
WLS28XW850X	WLS28CW850X	WLS28XW850XPB	WLS28CW850XPB	850 mm	
WLS28XW990X	WLS28CW990X	WLS28XW990XPB	WLS28CW990XPB	990 mm	
WLS28XW1130X	WLS28CW1130X	WLS28XW1130XPB	WLS28CW1130XPB	1130 mm	

Table 2: IP67/IP69K Models

Models		Lighted Length	Power Connector ¹
Stand-Alone	Cascade		
WLS28XW145S	WLS28CW145S	145 mm	2 m cable
WLS28XW285S	WLS28CW285S	285 mm	
WLS28XW430S	WLS28CW430S	430 mm	
WLS28XW570S	WLS28CW570S	570 mm	
WLS28XW710S	WLS28CW710S	710 mm	
WLS28XW850S	WLS28CW850S	850 mm	
WLS28XW990S	WLS28CW990S	990 mm	
WLS28XW1130S	WLS28CW1130S	1130 mm	

¹ Only cabled power connector models are listed. To order the 4-pin M12/Euro-style integral power connector models, add the suffix Q to the model number (for example, WLS28XW285XQ).

Specifications

Supply Voltage and Current

12 to 30 V dc (10% maximum ripple)

Use only with suitable Class 2 power supply (UL) or a SELV power supply (CE).

Light Length (mm)	Maximum Current and Power				Lumens ² (Typical at 25 °C)					
	12 V dc	24 V dc	30 V dc	Watts	Cool White	Warm White	Green	Red	Yellow	Blue
145	0.5 A	0.25 A	0.2 A	6	225	180	126	60	114	36
285	0.75 A	0.375 A	0.3 A	9	450	360	252	120	228	72
430	1.25 A	0.625 A	0.5 A	15	675	540	378	180	342	108
570	1.5 A	0.75 A	0.6 A	18	900	720	504	240	458	144
710	2.0 A	1.0 A	0.8 A	24	1125	900	630	300	570	180
850	2.25 A	1.125 A	0.9 A	27	1350	1080	756	360	684	216
990	2.75 A	1.375 A	1.1 A	33	1575	1260	882	420	798	252
1130	3.0 A	1.5 A	1.2 A	36	1800	1440	1008	480	912	288

Light Characteristics

Color Temperature and Wavelengths

Cool White: 5300–7000K

Warm White: 2600–4300K

Green: 520–535 nm

Red: 620–630 nm

Yellow: 585–595 nm

Blue: 460–475 nm

Useful Life

When operating within specifications, output will decrease less than 30% after 50,000 hours.

Construction

Clear anodized aluminum housing; painted zinc end caps; polycarbonate window; zinc plated steel brackets

Mounting

(2) swivel brackets SMBWLS28RA included and (4) screws



NOTE: Do not spray cable with high-pressure sprayer, or cable damage will result.

Environmental Rating

IEC IP50 (non-sealed models) or IEC IP67/IP69K per DIN 40050 (sealed models)

Connections

Integral 4-pin M12 quick disconnect fitting (4-pin connecting cordset required for QD models); or 2 m (6.5 ft) integral cable

Operating Temperature

–20 °C to +50 °C (–4 °F to +122 °F)

Storage Temperature

–40 °C to +70 °C (–40 °F to +158 °F)

Certifications



L25 models: UL pending

Application Notes

When connecting cascable lights in series it is important not to exceed maximum current limitations:

Maximum length of light at 12 V dc: 1.5 m (4.9 ft)

Maximum length of light at 24 V dc: 3.0 m (9.8 ft)

Maximum length of light at 30 V dc: 3.1 m (10.2 ft)

Maximum Ambient Operating Temperature for inside the cabinet of 50°C

Dimensions

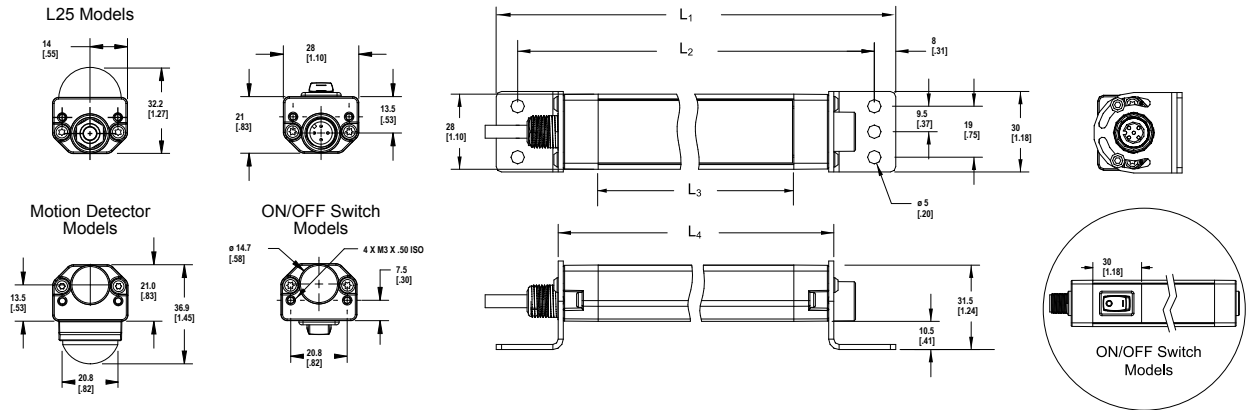

Dimensions are shown with included SMBWLS28RA bracket

² Lumen values lowered by 35% on diffused window models.

Non-Switch Models					
IP50 Models	IP67/IP69K Models	L ₁	L ₂	L ₃	L ₄
WLS28..145X	WLS28..145S	221 mm (8.7 in)	205 mm (8.1 in)	145 mm (5.71 in)	175 mm (6.9 in)
WLS28..285X	WLS28..285S	362 mm (14.3 in)	346 mm (13.6 in)	286 mm (11.26 in)	316 mm (12.4 in)
WLS28..430X	WLS28..430S	503 mm (19.8 in)	487 mm (19.2 in)	427 mm (16.81 in)	457 mm (18.0 in)
WLS28..570X	WLS28..570S	644 mm (25.4 in)	628 mm (24.7 in)	568 mm (22.36 in)	598 mm (23.5 in)
WLS28..710X	WLS28..710S	785 mm (30.9 in)	769 mm (30.3 in)	709 mm (27.91 in)	739 mm (29.1 in)
WLS28..850X	WLS28..850S	926 mm (36.5 in)	910 mm (35.8 in)	850 mm (33.46 in)	880 mm (34.6 in)
WLS28..990X	WLS28..990S	1067 mm (42 in)	1051 mm (41.4 in)	991 mm (39.02 in)	1021 mm (40.2 in)
WLS28..1130X	WLS28..1130S	1208 mm (47.6 in)	1192 mm (46.9 in)	1132 mm (44.57 in)	1162 mm (45.7 in)

ON/OFF Switch Models					
Model	L ₁	L ₂	L ₃	L ₄	
WLS28..145XPB	251 mm (9.9 in)	235 mm (9.3 in)	145 mm (5.71 in)	205 mm (8.1 in)	
WLS28..285XPB	392 mm (15.4 in)	376 mm (14.8 in)	286 mm (11.26 in)	346 mm (13.6 in)	
WLS28..430XPB	533 mm (21.0 in)	517 mm (20.4 in)	427 mm (16.81 in)	487 mm (19.2 in)	
WLS28..570XPB	674 mm (26.5 in)	658 mm (25.9 in)	568 mm (22.36 in)	628 mm (24.7 in)	
WLS28..710XPB	815 mm (32.1 in)	799 mm (31.5 in)	709 mm (27.91 in)	769 mm (30.3 in)	
WLS28..850XPB	956 mm (37.6 in)	940 mm (37 in)	850 mm (33.46 in)	910 mm (35.8 in)	
WLS28..990XPB	1097 mm (43.2 in)	1081 mm (42.6 in)	991 mm (39.02 in)	1051 mm (41.4 in)	
WLS28..1130XPB	1238 mm (48.7 in)	1222 mm (48.1 in)	1132 mm (44.57 in)	1192 mm (46.9 in)	

Wiring

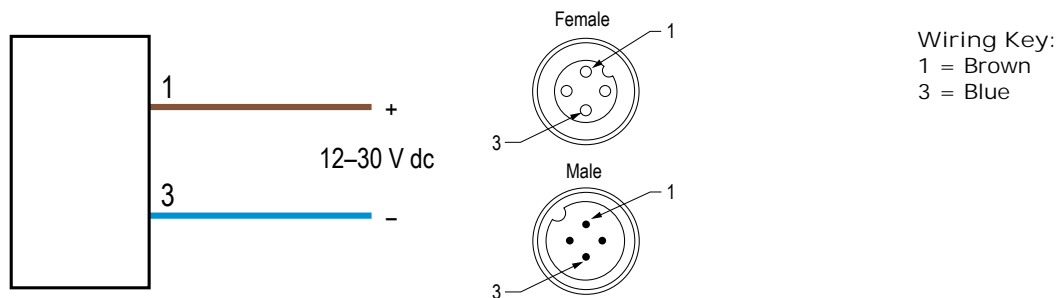

Accessories

Cordsets

Single-ended cordsets are for use between power source and QD connection of stand-alone light or first light in a cascade.

Double-ended cordsets are for use between lights in a cascade.

Single-Ended Cordsets

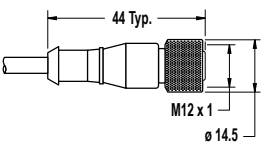
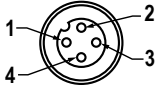
4-Pin Threaded M12/Euro-Style Cordsets				
Model	Length	Style	Dimensions	Pinout (Female)
MQDC-406	1.83 m (6 ft)	Straight		 1 = Brown 2 = White 3 = Blue 4 = Black
MQDC-415	4.57 m (15 ft)			
MQDC-430	9.14 m (30 ft)			
MQDC-450	15.2 m (50 ft)			
MQDC-406RA	1.83 m (6 ft)	Right-Angle		
MQDC-415RA	4.57 m (15 ft)			
MQDC-430RA	9.14 m (30 ft)			
MQDC-450RA	15.2 m (50 ft)			

Double-Ended Cordsets

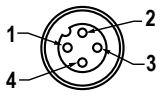
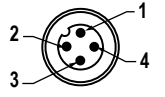
4-Pin Threaded M12/Euro-Style Cordsets—Double Ended				
Model	Length	Style	Dimensions	Pinout
MQDEC-401SS	0.31 m (1 ft)	Male Straight/ Female Straight		Female
MQDEC-403SS	0.91 m (3 ft)			
MQDEC-406SS	1.83 m (6 ft)			Male
MQDEC-412SS	3.66 m (12 ft)			
MQDEC-420SS	6.10 m (20 ft)			1 = Brown 2 = White 3 = Blue 4 = Black
MQDEC-430SS	9.14 m (30 ft)			
MQDEC-450SS	15.2 m (50 ft)			

Splitter Cordsets

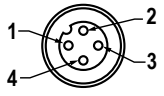
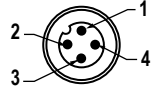
4-Pin Threaded M12/Euro-Style Splitter Cordsets — Flat Junction			
Model	Branches (Female)	Trunk (Male)	Pinout
CSB-M1240M1240	No branch	No trunk	Female  Male  1 = Brown 2 = White 3 = Blue 4 = Black
CSB-M1240M1241		No trunk	
CSB-M1241M1241		0.30 m (1 ft)	
CSB-M1248M1241		2.50 m (8 ft)	
CSB-M12415M1241		4.57 m (15 ft)	
CSB-M12425M1241		7.60 m (25 ft)	
CSB-UNT425M1241	2 x 0.30 m (1 ft)	7.60 m (25 ft) Unterminated	

4-Pin Threaded M12/Euro-Style Splitter Cordsets — Flat Junction			
Model	Branches (Female)	Trunk (Male)	Pinout

Replacement Bracket and Unistrut Mounting Hardware

<p>SMBWLS28RA</p> <p>The bracket kit is available as a replacement for the one that comes with the Work Light Strip. The kit contains two end brackets and four screws.</p>	<p>SMBWLS28SM</p> <p>This kit allows the light to be mounted at a right angle to the mounting surface. The kit contains two end brackets and four screws.</p>
<p>SMH1316</p> <p>This kit allows the light to be mounted to a 13/16-inch Unistrut channel. The kit includes:</p> <ul style="list-style-type: none"> • #10-32 spring nuts (qty 2) • #10-32 socket head cap screws (qty 2) • #10 lock washers (qty 2) 	<p>SMBWLSMAG</p> <p>Magnetic mounting bracket for easy attachment to steel surfaces</p> <p>SMBWLSMAGR</p> <p>Protective cover also available to prevent scratches to painted surfaces</p>

Banner Engineering Corp. Limited Warranty

Banner Engineering Corp. warrants its products to be free from defects in material and workmanship for one year following the date of shipment. Banner Engineering Corp. will repair or replace, free of charge, any product of its manufacture which, at the time it is returned to the factory, is found to have been defective during the warranty period. This warranty does not cover damage or liability for misuse, abuse, or the improper application or installation of the Banner product.

THIS LIMITED WARRANTY IS EXCLUSIVE AND IN LIEU OF ALL OTHER WARRANTIES WHETHER EXPRESS OR IMPLIED (INCLUDING, WITHOUT LIMITATION, ANY WARRANTY OF MERCHANTABILITY OR FITNESS FOR A PARTICULAR PURPOSE), AND WHETHER ARISING UNDER COURSE OF PERFORMANCE, COURSE OF DEALING OR TRADE USAGE.

This Warranty is exclusive and limited to repair or, at the discretion of Banner Engineering Corp., replacement. IN NO EVENT SHALL BANNER ENGINEERING CORP. BE LIABLE TO BUYER OR ANY OTHER PERSON OR ENTITY FOR ANY EXTRA COSTS, EXPENSES, LOSSES, LOSS OF PROFITS, OR ANY INCIDENTAL, CONSEQUENTIAL OR SPECIAL DAMAGES RESULTING FROM ANY PRODUCT DEFECT OR FROM THE USE OR INABILITY TO USE THE PRODUCT, WHETHER ARISING IN CONTRACT OR WARRANTY, STATUTE, TORT, STRICT LIABILITY, NEGLIGENCE, OR OTHERWISE.

Banner Engineering Corp. reserves the right to change, modify or improve the design of the product without assuming any obligations or liabilities relating to any product previously manufactured by Banner Engineering Corp.