

## DS36277

# Dominant Mode Multipoint Transceiver

### General Description

The DS36277 Dominant Mode Multipoint Transceiver is designed for use on bi-directional differential busses. It is optimal for use on Interfaces that utilize Society of Automotive Engineers (SAE) J1708 Electrical Standard.

The device is similar to standard TIA/EIA-485 transceivers, but differs in enabling scheme. The Driver's Input is normally externally tied LOW, thus providing only two states: Active (LOW), or Disabled (OFF). When the driver is active, the dominant mode is LOW, conversely, when the driver is disabled, the bus is pulled HIGH by external bias resistors.

The receiver provides a FAILSAFE feature that guarantees a known output state when the Interface is in the following conditions: Floating Line, Idle Line (no active drivers), and Line Fault Conditions (open or short). The receiver output is HIGH for the following conditions: Open Inputs, Terminated Inputs (50Ω), or Shorted Inputs. FAILSAFE is a highly desirable feature when the transceivers are used with Asynchronous Controllers such as UARTs.

### Features

- FAILSAFE receiver, RO = HIGH for:
  - OPEN inputs
  - Terminated inputs
  - SHORTED inputs
- Optimal for use in SAE J1708 Interfaces
- Compatible with popular interface standards:
  - TIA/EIA-485 and TIA/EIA-422-A
  - CCITT recommendation V.11
- Bi-directional transceiver
  - Designed for multipoint transmission
- Wide bus common mode range
  - (-7V to +12V)
- Available in plastic DIP and SOIC packages

### Connection and Logic Diagram

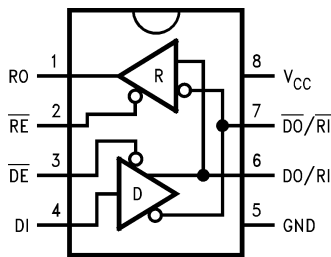

01138401

Order Number DS36277TM or DS36277TN  
See NS Package Number M08A or N08E

### Truth Tables

#### Driver

Inputs		Outputs	
$\overline{DE}$	DI	DO/RI	$\overline{DO}/\overline{RI}$
L	L	L	H
L	H	H	L
H	X	Z	Z

#### Receiver

Inputs	Output	
$\overline{RE}$	DO/RI- $\overline{DO}/\overline{RI}$	RO
L	$\geq 0$ mV	H
L	$\leq -500$ mV	L
L	SHORTED	H
L	OPEN	H
H	X	Z

**Absolute Maximum Ratings** (Note 1)

If Military/Aerospace specified devices are required, please contact the National Semiconductor Sales Office/Distributors for availability and specifications.

Supply Voltage ( $V_{CC}$ )	7V
Input Voltage ( $\overline{DE}$ , $\overline{RE}$ , and DI)	5.5V
Driver Output Voltage/	
Receiver Input Voltage	-10V to +15V
Receiver Output Voltage (RO)	5.5V
Maximum Package Power Dissipation @ +25°C	
N Package	
(derate 9.3 mW/°C above +25°C)	1168 mW
M Package	
(derate 5.8 mW/°C above +25°C)	726 mW

Storage Temperature Range	-65°C to +150°C
Lead Temperature (Soldering 4 sec.)	260°C
ESD Rating (HBM, 1.5 kΩ, 100 pF)	5.0 kV

**Recommended Operating Conditions**

	Min	Max	Units
Supply Voltage, $V_{CC}$	4.75	5.25	V
Bus Voltage	-7	+12	V
Operating Temperature ( $T_A$ )			
DS36277T	-40	+85	°C

**Electrical Characteristics** (Notes 2, 4)

Over recommended Supply Voltage and Operating Temperature ranges, unless otherwise specified.

Symbol	Parameter	Conditions	Min	Typ	Max	Units	
<b>DRIVER CHARACTERISTICS</b>							
$V_{OD}$	Differential Output Voltage	$I_O = 0$ mA (No Load)	1.5	3.6	6	V	
$V_{oDO}$	Output Voltage	$I_O = 0$ mA (Output to GND)	0		6	V	
$V_{o\overline{DO}}$	Output Voltage		0		6	V	
$V_{T1}$	Differential Output Voltage (Termination Load)	$R_L = 54\Omega$ (485)	(Figure 1)		5.0	V	
		$R_L = 100\Omega$ (422)	1.3	2.2	5.0	V	
$\Delta V_{T1}$	Balance of $V_{T1}$ $ V_{T1} - \overline{V_{T1}} $	$R_L = 54\Omega$	(Note 3)		0.2	V	
		$R_L = 100\Omega$	-0.2		0.2	V	
$V_{OS}$	Driver Common Mode Output Voltage	$R_L = 54\Omega$	(Figure 1)		3.0	V	
		$R_L = 100\Omega$	0	2.5	3.0	V	
$\Delta V_{OS}$	Balance of $V_{OS}$ $ V_{OS} - \overline{V_{OS}} $	$R_L = 54\Omega$	(Note 3)		0.2	V	
		$R_L = 100\Omega$	-0.2		0.2	V	
$V_{OH}$	Output Voltage High	$I_{OH} = -22$ mA	(Figure 2)			V	
$V_{OL}$	Output Voltage Low	$I_{OL} = +22$ mA		1.3	2	V	
$I_{OSD}$	Driver Short-Circuit Output Current	$V_O = +12V$	(Figure 3)		290	mA	
		$V_O = -7V$		-187	-290	mA	
<b>RECEIVER CHARACTERISTICS</b>							
$V_{TH}$	Differential Input High Threshold Voltage (Note 5)	$V_O = V_{OH}$ , $I_O = -0.4$ mA $-7V \leq V_{CM} \leq +12V$		-0.150	0	V	
$V_{TL}$	Differential Input Low Threshold Voltage (Note 5)	$V_O = V_{OL}$ , $I_O = 8.0$ mA $-7V \leq V_{CM} \leq +12V$	-0.5	-0.230		V	
$V_{HST}$	Hysteresis (Note 6)	$V_{CM} = 0V$		80		mV	
$I_{IN}$	Line Input Current ( $V_{CC} = 4.75V, 5.25V, 0V$ )	Other Input = 0V $\overline{DE} = V_{IH}$ (Note 7)	$V_I = +12V$	0.5	1.5	mA	
			$V_I = -7V$	-0.5	-1.5	mA	
$I_{OSR}$	Short Circuit Current	$V_O = 0V$	RO	-15	-32	mA	
$I_{OZ}$	TRI-STATE® Leakage Current	$V_O = 0.4$ to 2.4V		-20	1.4	+20	μA
$V_{OH}$	Output High Voltage (Figure 12)	$V_{ID} = 0V$ , $I_{OH} = -0.4$ mA		2.3	3.7		V
		$V_{ID} = OPEN$ , $I_{OH} = -0.4$ mA		2.3	3.7		V
$V_{OL}$	Output Low Voltage (Figure 12)	$V_{ID} = -0.5V$ , $I_{OL} = +8$ mA			0.3	0.7	V
		$V_{ID} = -0.5V$ , $I_{OL} = +16$ mA			0.3	0.8	V
$R_{IN}$	Input Resistance		10	20		kΩ	

## Electrical Characteristics (Notes 2, 4) (Continued)

Over recommended Supply Voltage and Operating Temperature ranges, unless otherwise specified.

Symbol	Parameter	Conditions	Min	Typ	Max	Units	
<b>DEVICE CHARACTERISTICS</b>							
$V_{IH}$	High Level Input Voltage		$\overline{DE}$ , $\overline{RE}$ , or DI	2.0	$V_{CC}$	V	
$V_{IL}$	Low Level Input Voltage			GND	0.8	V	
$I_{IH}$	High Level Input Current	$V_{IH} = 2.4V$				20	$\mu A$
$I_{IL}$	Low Level Input Current	$V_{IL} = 0.4V$				-100	$\mu A$
$V_{CL}$	Input Clamp Voltage	$I_{CL} = -18 \text{ mA}$		-0.7	-1.5	V	
$I_{CC}$	Output Low Voltage	$\overline{DE} = 0V, \overline{RE} = 0V, DI = 0V$		39	60	mA	
$I_{CCR}$	Supply Current	$\overline{DE} = 3V, \overline{RE} = 0V, DI = 0V$		24	50	mA	
$I_{CCD}$	(No Load)	$\overline{DE} = 0V, \overline{RE} = 3V, DI = 0V$		40	75	mA	
$I_{CCX}$		$\overline{DE} = 3V, \overline{RE} = 3V, DI = 0V$		27	45	mA	

## Switching Characteristics (Note 4)

Over recommended Supply Voltage and Operating Temperature ranges, unless otherwise specified.

Symbol	Parameter	Conditions	Min	Typ	Max	Units
<b>DRIVER CHARACTERISTICS</b>						
$t_{PLHD}$	Diff. Prop. Delay Low to High	$R_L = 54\Omega$	8	17	60	ns
$t_{PHLD}$	Diff. Prop. Delay High to Low	$C_L = 50 \text{ pF}$	8	19	60	ns
$t_{SKD}$	Diff. Skew ( $t_{PLHD} - t_{PHLD}$ )	$C_D = 50 \text{ pF}$		2	10	ns
$t_r$	Diff. Rise Time	(Figures 4, 5)		11	60	ns
$t_f$	Diff. Fall Time			11	60	ns
$t_{PLH}$	Prop. Delay Low to High	$R_L = 27\Omega, C_L = 15 \text{ pF}$		22	85	ns
$t_{PHL}$	Prop. Delay High to Low	(Figures 6, 7)		25	85	ns
$t_{PZH}$	Enable Time Z to High	$R_L = 110\Omega$		25	60	ns
$t_{PZL}$	Enable Time Z to Low	$C_L = 50 \text{ pF}$		30	60	ns
$t_{PHZ}$	Disable Time High to Z	(Figure 8 – Figure 11)		16	60	ns
$t_{PLZ}$	Disable Time Low to Z			11	60	ns
<b>RECEIVER CHARACTERISTICS</b>						
$t_{PLH}$	Prop. Delay Low to High	$V_{ID} = -1.5V \text{ to } +1.5V$	15	37	90	ns
$t_{PHL}$	Prop. Delay High to Low	$C_L = 15 \text{ pF}$	15	43	90	ns
$t_{SK}$	Skew ( $t_{PLH} - t_{PHL}$ )	(Figures 13, 14)		6	15	ns
$t_{PZH}$	Enable Time Z to High	$C_L = 15 \text{ pF}$		12	60	ns
$t_{PZL}$	Enable Time Z to Low	(Figures 15, 16)		28	60	ns
$t_{PHZ}$	Disable Time High to Z			20	60	ns
$t_{PLZ}$	Disable Time Low to Z			10	60	ns

**Note 1:** “Absolute Maximum Ratings” are those values beyond which the safety of the device cannot be guaranteed. They are not meant to imply that the devices should be operated at these limits. The tables of “Electrical Characteristics” specify conditions for device operation.

**Note 2:** Current into device pins is defined as positive. Current out of device pins is defined as negative. All voltages are referenced to ground unless otherwise specified.

**Note 3:**  $\Delta |V_{T1}|$  and  $\Delta |V_{OS}|$  are changes in magnitude of  $V_{T1}$  and  $V_{OS}$ , respectively, that occur when the input changes state.

**Note 4:** All typicals are given for  $V_{CC} = 5.0V$  and  $T_A = +25^\circ C$ .

**Note 5:** Threshold parameter limits specified as an algebraic value rather than by magnitude.

**Note 6:** Hysteresis defined as  $V_{HST} = V_{TH} - V_{TL}$ .

**Note 7:**  $I_{IN}$  includes the receiver input current and driver TRI-STATE leakage current.

# Parameter Measurement Information

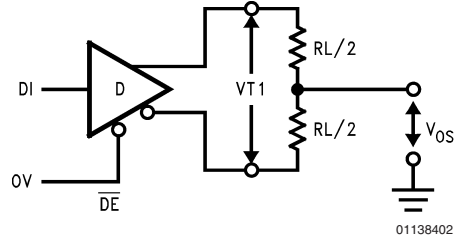

FIGURE 1. Driver  $V_{T1}$  and  $V_{OS}$  Test Circuit

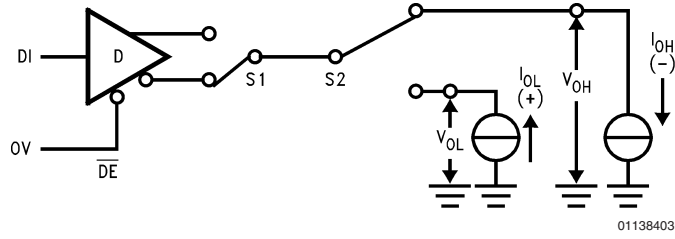

FIGURE 2. Driver  $V_{OH}$  and  $V_{OL}$  Test Circuit

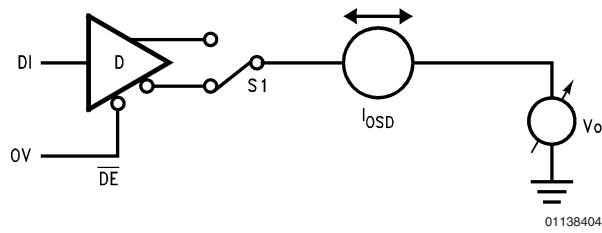

FIGURE 3. Driver Short Circuit Test Circuit

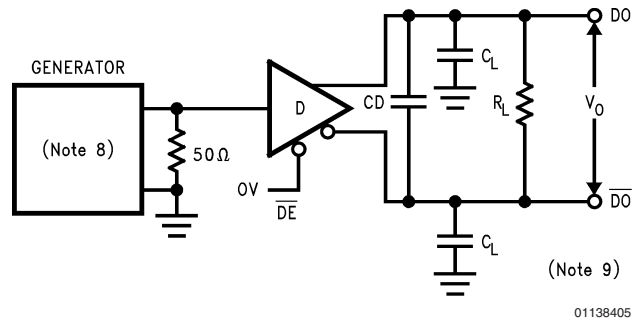

FIGURE 4. Driver Differential Propagation Delay and Transition Time Test Circuit

Parameter Measurement Information (Continued)

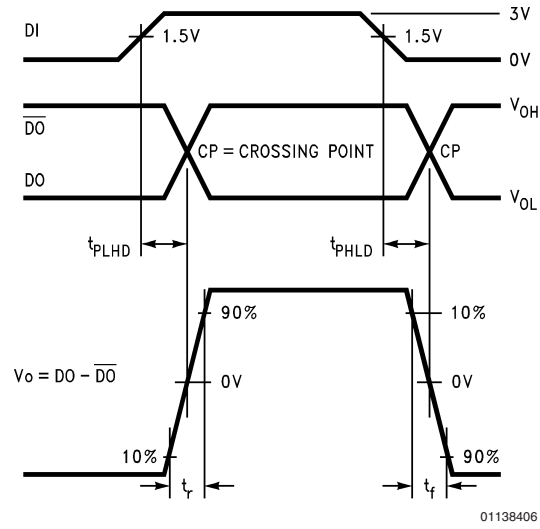

FIGURE 5. Driver Differential Propagation Delays and Transition Times

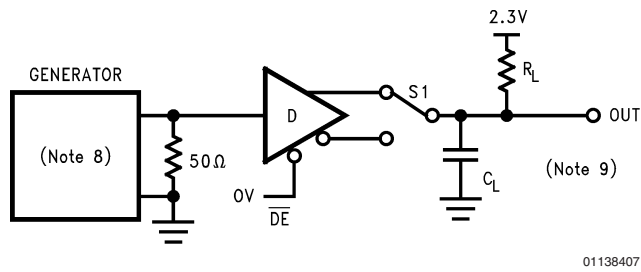

FIGURE 6. Driver Propagation Delay Test Circuit

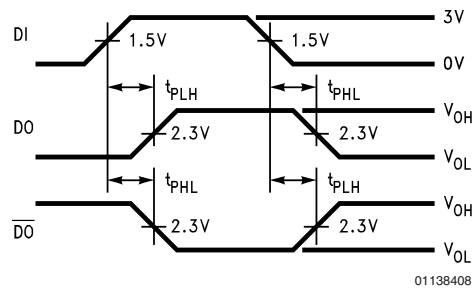
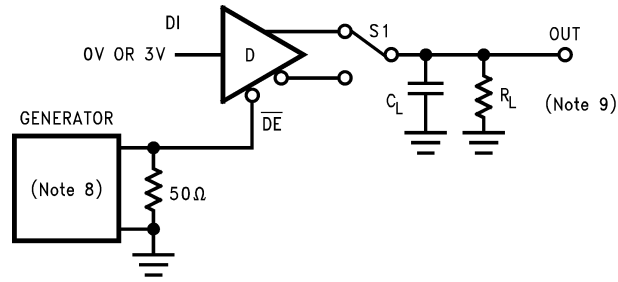

FIGURE 7. Driver Propagation Delays

Parameter Measurement Information (Continued)



01138409

S1 to DO for DI = 3V  
S1 to  $\overline{DO}$  for DI = 0V

FIGURE 8. Driver TRI-STATE Test Circuit ( $t_{pZH}$ ,  $t_{pHZ}$ )

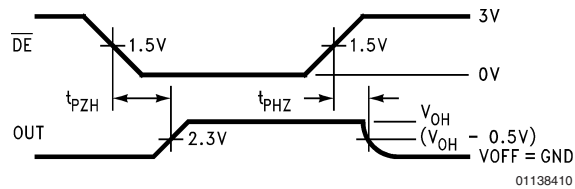

01138410

FIGURE 9. Driver TRI-STATE Delays ( $t_{pZH}$ ,  $t_{pHZ}$ )

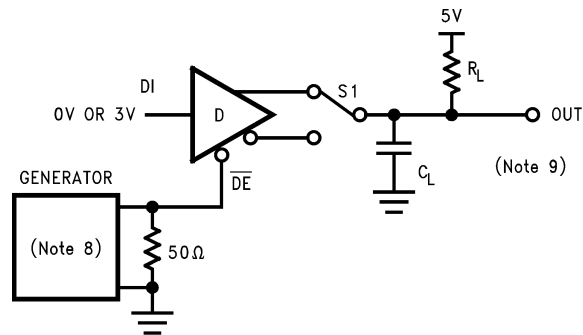

01138411

S1 to DO for DI = 0V  
S1 to  $\overline{DO}$  for DI = 3V

FIGURE 10. Driver TRI-STATE Test Circuit ( $t_{pZL}$ ,  $t_{pLZ}$ )

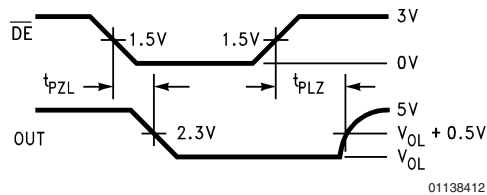

01138412

FIGURE 11. Driver TRI-STATE Delays ( $t_{pZL}$ ,  $t_{pLZ}$ )

Parameter Measurement Information (Continued)

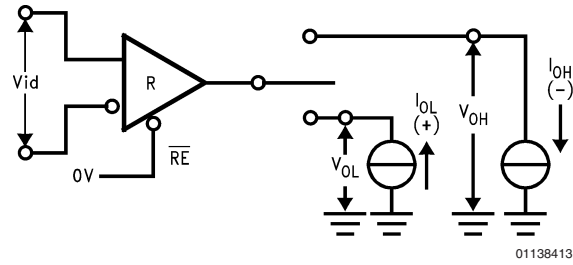

FIGURE 12. Receiver  $V_{OH}$  and  $V_{OL}$

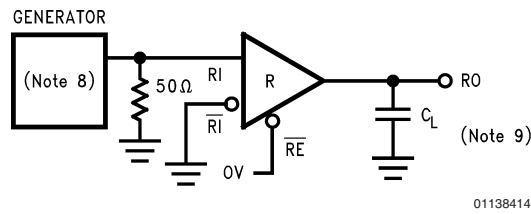

FIGURE 13. Receiver Propagation Delay Test Circuit

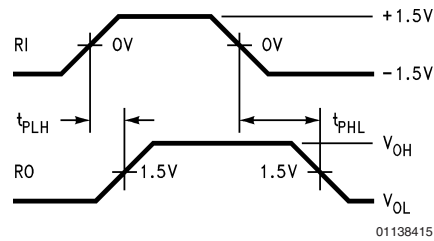

FIGURE 14. Receiver Propagation Delays

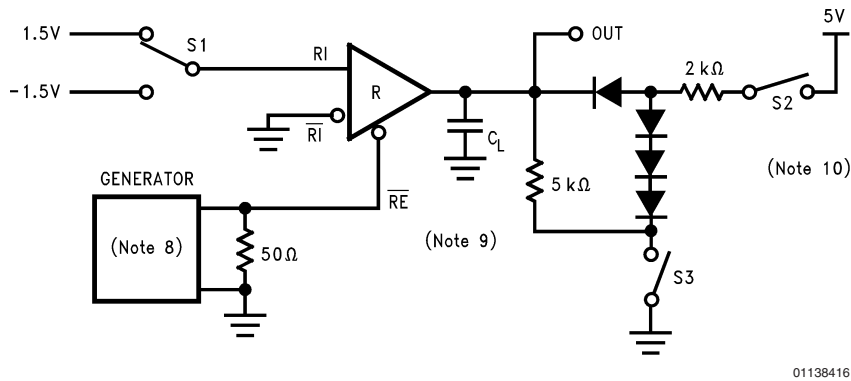
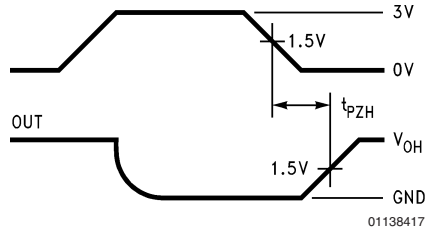
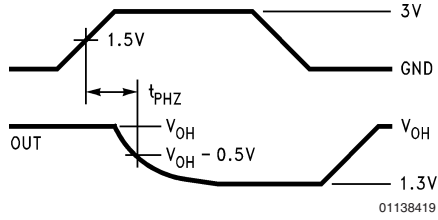

FIGURE 15. Receiver TRI-STATE Delay Test Circuit

Parameter Measurement Information (Continued)



S1 1.5V  
S2 OPEN  
S3 CLOSED



S1 1.5V  
S2 CLOSED  
S3 CLOSED

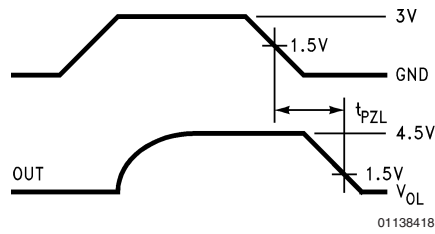

S1 -1.5V  
S2 CLOSED  
S3 OPEN

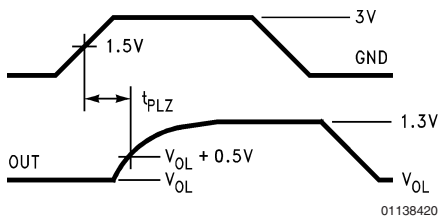

S1 -1.5V  
S2 CLOSED  
S3 CLOSED

FIGURE 16. Receiver Enable and Disable Timing

**Note 8:** The input pulse is supplied by a generator having the following characteristics:  $f = 1.0$  MHz, 50% duty cycle,  $t_r$  and  $t_f < 6.0$  ns,  $Z_O = 50\Omega$ .

**Note 9:**  $C_L$  includes probe and stray capacitance.

**Note 10:** Diodes are 1N916 or equivalent.



# Typical Performance Characteristics

Differential Output Voltage vs Output Current

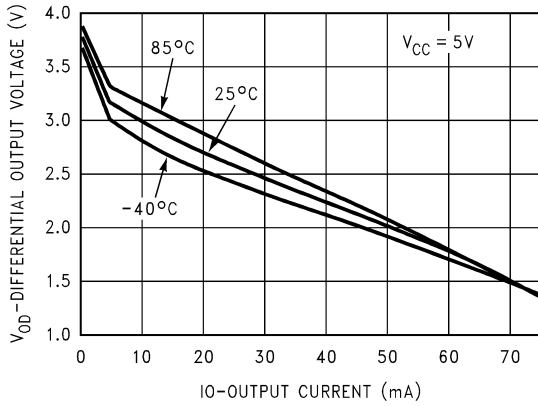

01138422

Differential Output Voltage vs Output Current

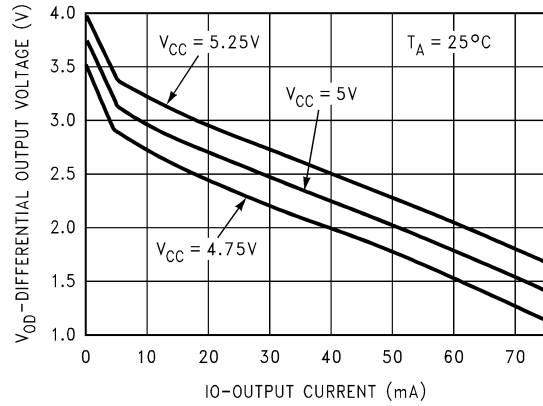

01138423

Driver  $V_{OH}$  vs  $I_{OH}$  vs  $V_{CC}$

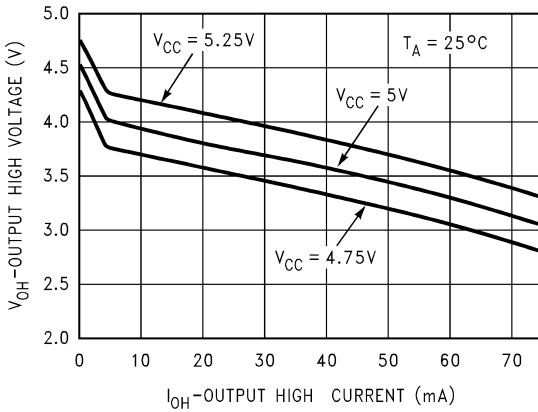

01138424

Driver  $V_{OH}$  vs  $I_{OH}$  vs Temperature

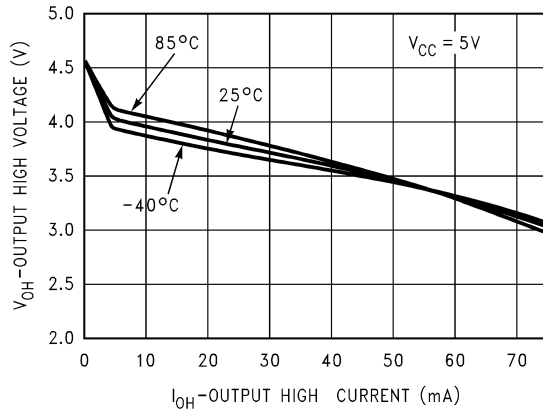

01138425

Driver  $V_{OL}$  vs  $I_{OL}$  vs  $V_{CC}$

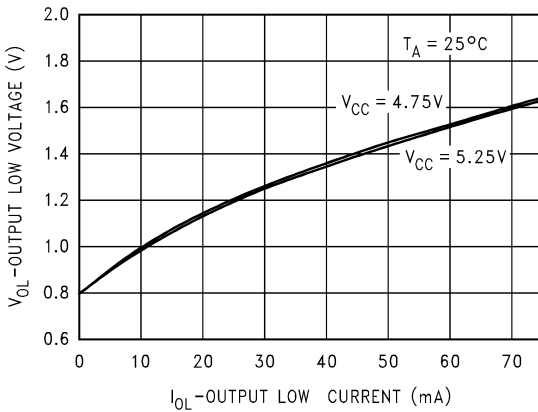

01138426

Driver  $V_{OL}$  vs  $I_{OL}$  vs Temperature

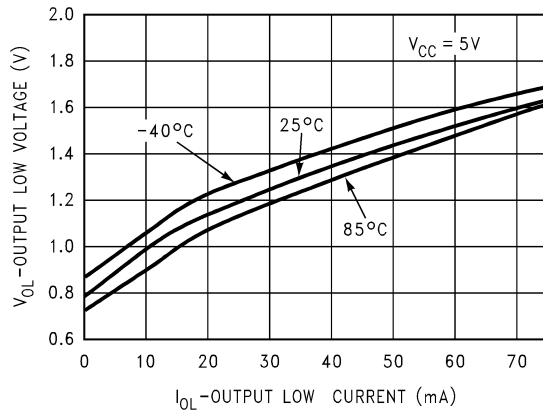

01138427

Typical Performance Characteristics (Continued)

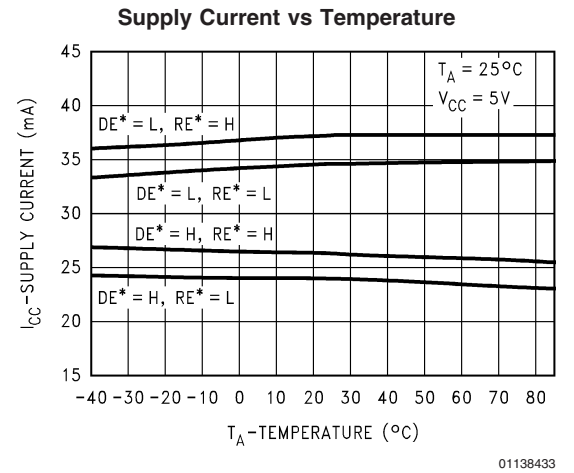
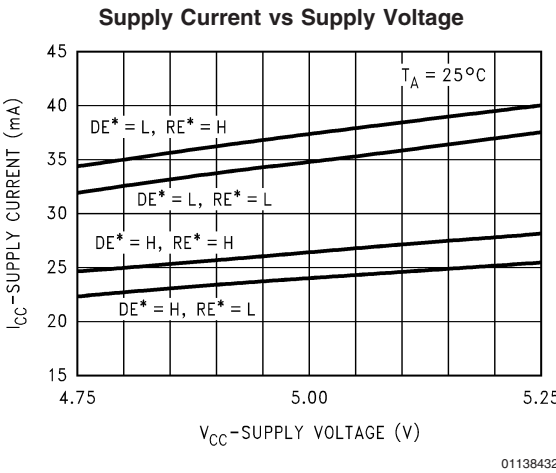
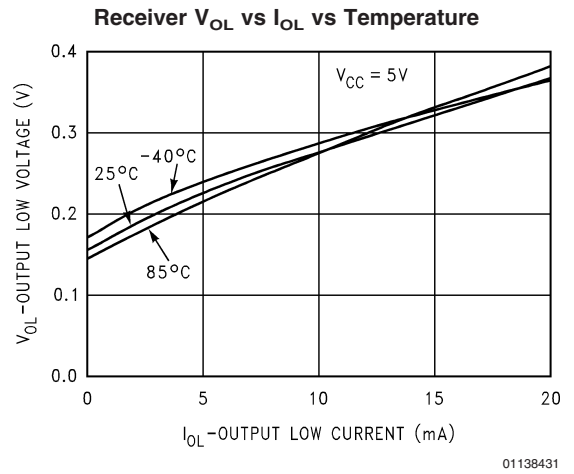
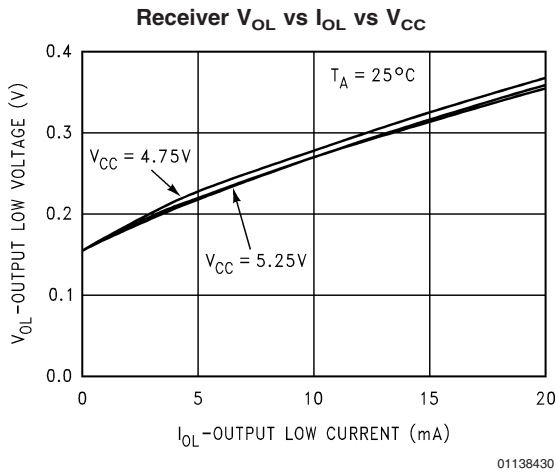
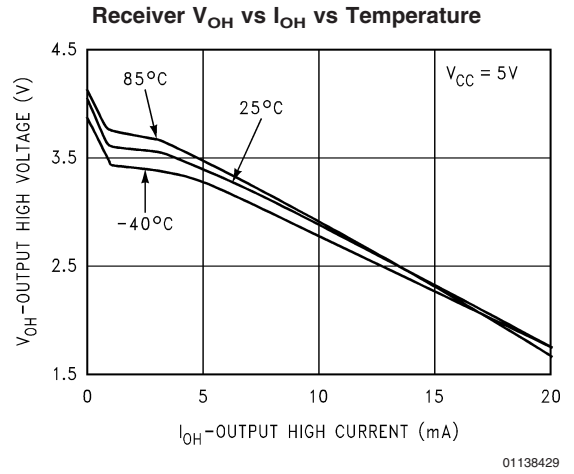
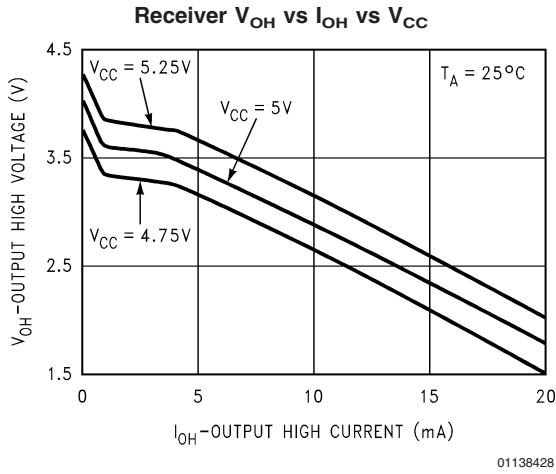

## Typical Performance Characteristics (Continued)

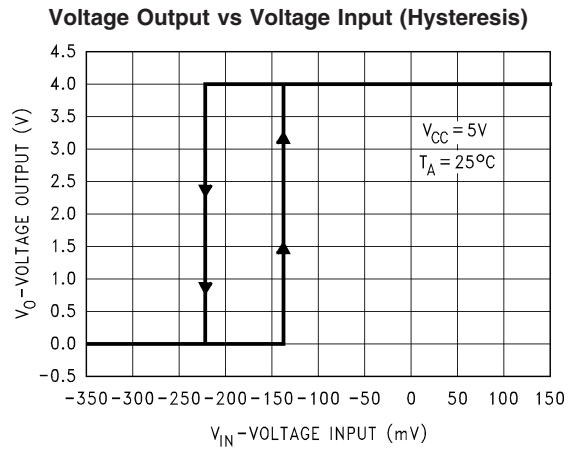

## Typical Applications Information

**SAE J1708 Node with External Bias Resistors and Filters**

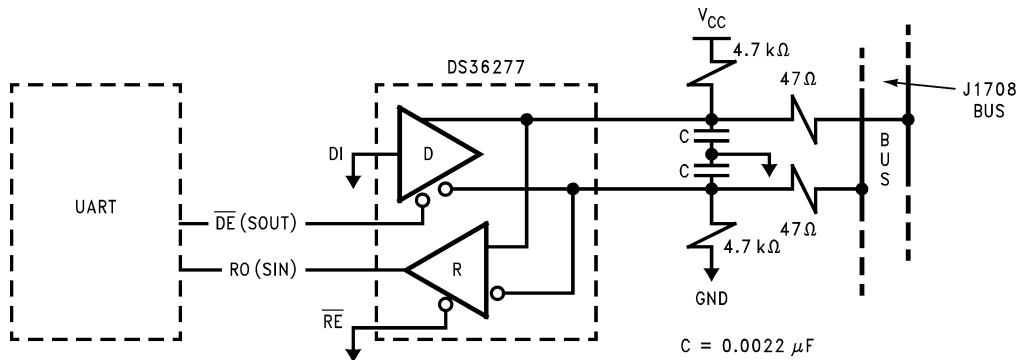

**Physical Dimensions** inches (millimeters) unless otherwise noted

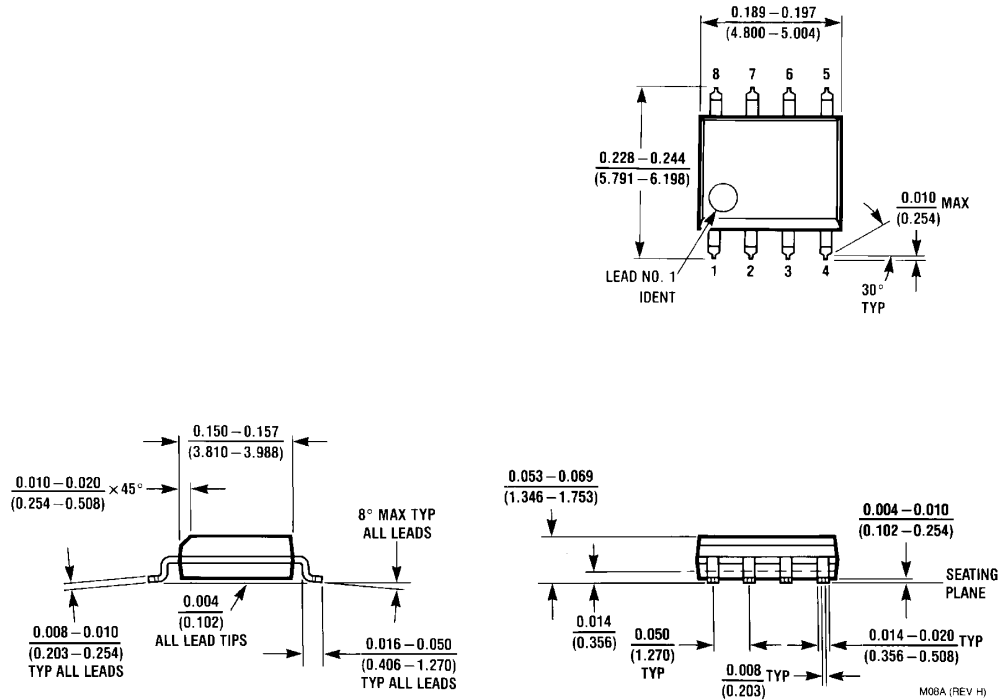

**8-Lead Molded Package (SO)**  
**Order Number DS36277TM**  
**NS Package Number M08A**

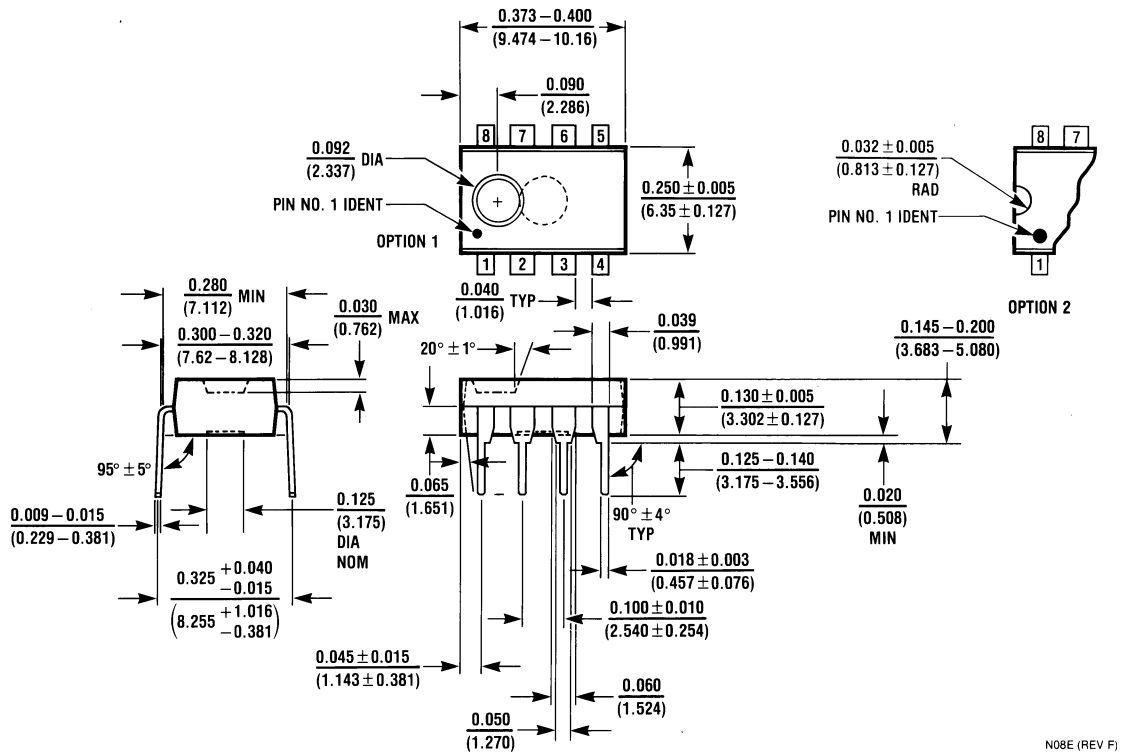

**8-Lead Molded Dual-In-Line Package (N)**  
**Order Number DS36277TN**  
**NS Package Number N08E**

## Notes

National does not assume any responsibility for use of any circuitry described, no circuit patent licenses are implied and National reserves the right at any time without notice to change said circuitry and specifications.

For the most current product information visit us at [www.national.com](http://www.national.com).

### LIFE SUPPORT POLICY

NATIONAL'S PRODUCTS ARE NOT AUTHORIZED FOR USE AS CRITICAL COMPONENTS IN LIFE SUPPORT DEVICES OR SYSTEMS WITHOUT THE EXPRESS WRITTEN APPROVAL OF THE PRESIDENT AND GENERAL COUNSEL OF NATIONAL SEMICONDUCTOR CORPORATION. As used herein:

- |  |   |
|--|---|
| <p>1. Life support devices or systems are devices or systems which, (a) are intended for surgical implant into the body, or (b) support or sustain life, and whose failure to perform when properly used in accordance with instructions for use provided in the labeling, can be reasonably expected to result in a significant injury to the user.</p> | <p>2. A critical component is any component of a life support device or system whose failure to perform can be reasonably expected to cause the failure of the life support device or system, or to affect its safety or effectiveness.</p> |
|--|---|

### BANNED SUBSTANCE COMPLIANCE

National Semiconductor certifies that the products and packing materials meet the provisions of the Customer Products Stewardship Specification (CSP-9-111C2) and the Banned Substances and Materials of Interest Specification (CSP-9-111S2) and contain no "Banned Substances" as defined in CSP-9-111S2.



**National Semiconductor**  
**Americas Customer**  
**Support Center**  
 Email: [new.feedback@nsc.com](mailto:new.feedback@nsc.com)  
 Tel: 1-800-272-9959

**National Semiconductor**  
**Europe Customer Support Center**  
 Fax: +49 (0) 180-530 85 86  
 Email: [europe.support@nsc.com](mailto:europe.support@nsc.com)  
 Deutsch Tel: +49 (0) 69 9508 6208  
 English Tel: +44 (0) 870 24 0 2171  
 Français Tel: +33 (0) 1 41 91 8790

**National Semiconductor**  
**Asia Pacific Customer**  
**Support Center**  
 Email: [ap.support@nsc.com](mailto:ap.support@nsc.com)

**National Semiconductor**  
**Japan Customer Support Center**  
 Fax: 81-3-5639-7507  
 Email: [jpn.feedback@nsc.com](mailto:jpn.feedback@nsc.com)  
 Tel: 81-3-5639-7560