

### 3231

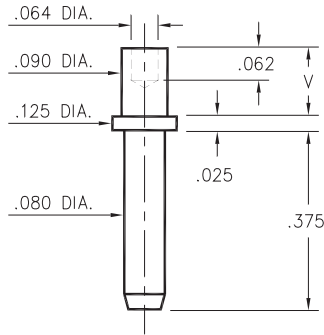

Basic Part Number	Board Thickness	Length V
3231-2	.062	.094
3231-3	.094	.125
3231-4	.125	.156

**3231-X-00-XX-00-00-08-0**  
Swage mount in .094 hole.

### 3609

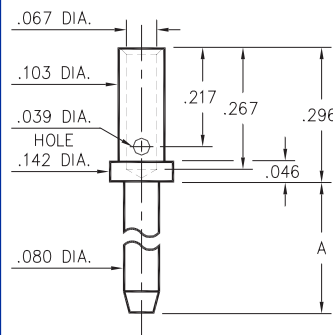

Basic Part Number	Pin Length A
3609-1	.200
3609-2	.375
3609-3	.500

**3609-X-07-XX-00-00-08-0**  
#16A Crimp barrel

### 3601

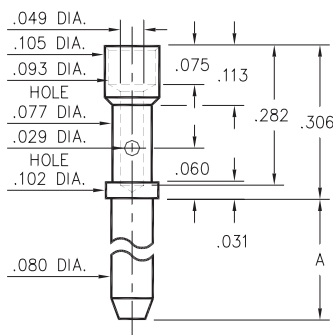

Basic Part Number	Pin Length A
3601-1	.200
3601-2	.375
3601-3	.500

**3601-X-07-XX-00-00-08-0**  
#20A Crimp barrel

### 3133/3138/3152

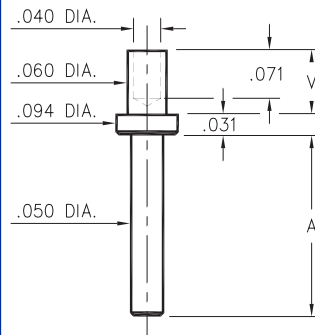

Basic Part Number	Pin Length A
3152-X	.094
3133-X	.219
3138-X	.282

- X -	Board Thickness	Length V
1	.031	.063
2	.062	.094
3	.094	.125
4	.125	.156

**31XX-X-00-XX-00-00-08-0**  
Specify board thickness  
Swage mount in .064 hole

### 3144

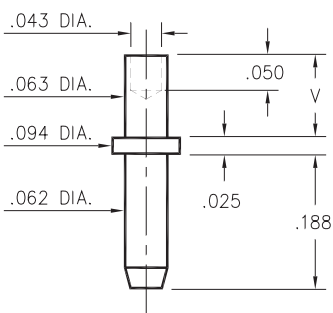

Basic Part Number	Board Thickness	Length V
3144-1	.031	.053
3144-2	.062	.084
3144-3	.094	.115

**3144-X-00-XX-00-00-08-0**  
Swage mount in .067 hole.

### 3233

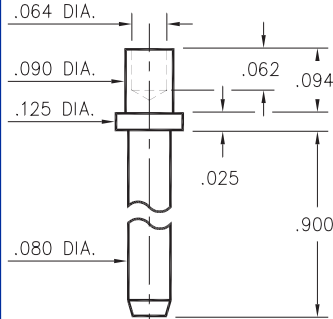

**3233-2-00-XX-00-00-08-0**  
Swage mount in .094 hole.  
For .062 thick board.

### 0520

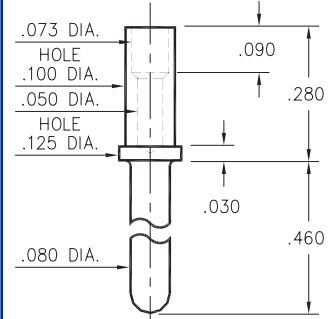

**0520-0-00-XX-00-00-03-0**  
Annealed  
#18 Gage crimp barrel

#### SPECIFICATIONS

**PIN MATERIAL:**  
Brass Alloy 360, 1/2 Hard  
( Except Swage pins which are annealed )

**DIMENSION IN INCHES**  
**TOLERANCES ON:**  
LENGTHS: ±.005  
DIAMETERS: ±.002  
ANGLES: ± 2°

**ORDER CODE: XXXX - X - 0X - XX - 00 - 00 - 0X - 0**

**BASIC PART #**

**SPECIFY PIN FINISH:**  
**01** 200µ" TIN/LEAD OVER NICKEL  
**80** 200µ" TIN OVER NICKEL  
**15** 10µ" GOLD OVER NICKEL  
**21** 20µ" GOLD OVER NICKEL  
**34** 50µ" GOLD OVER NICKEL

