

TGA2533

Ku-Band Power Amplifier



Applications

- Point-to-Point Radio
- Ku-Band VSAT

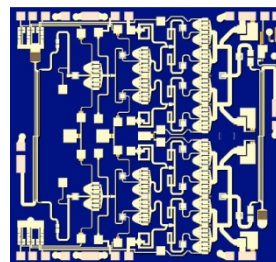

Product Features

- Frequency Range: 12.7 – 15.4 GHz
- TOI: 43dBm
- Power: 35 dBm Psat, 34 dBm P1dB
- Gain: 28 dB
- Return Loss: 15 dB
- NF: 6 dB
- Integrated Power Detector
- Bias: Vd = 6 V, Id = 1.3 A, Vg = -0.55 V Typical
- Dimensions: 3.2 x 3.0 x 0.1 mm

Functional Block Diagram

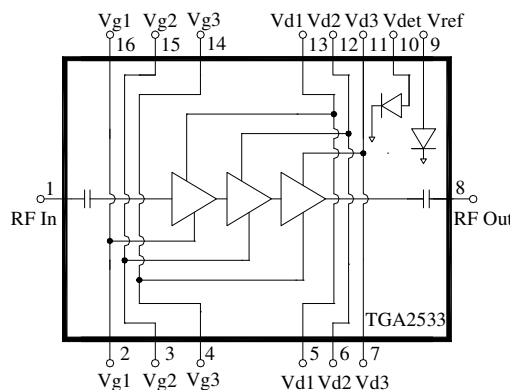

General Description

The TriQuint TGA2533 is a Ku-Band Power Amplifier. The TGA2533 operates from 12.7 to 15.4 GHz and is designed using TriQuint's power pHEMT production process.

The TGA2533 typically provides 43dBm of TOI at 20dBm Pout/Tone, 34 dBm of output power at 1 dB gain compression, and small signal gain is 28 dB.

The TGA2533 is ideally suited for Point-to-Point Radio and Ku-Band VSAT Ground Terminal.

Lead-free and RoHS compliant

Bond Pad Configuration

Bond Pad #	Symbol
1	RF In
2, 16	Vg1
3, 15	Vg2
4, 14	Vg3
5, 13	Vd1
6, 12	Vd2
7, 11	Vd3
8	RF Out
9	Vref
10	Vdet

Ordering Information

Part No.	ECCN	Description
TGA2533	3A001.b.2.c	Ku-band Power Amplifier

Standard order qty = 50 pieces.

Specifications

Absolute Maximum Ratings

Parameter	Rating
Drain Voltage, Vd	+8 V
Gate Voltage, Vg	-3 to 0 V
Drain Current, Id	2.24 A
Gate Current, Ig	-11 to 90 mA
Power Dissipation, Pdiss	17.9 W
RF Input Power, CW, 50Ω, T = 25°C	27 dBm
Channel Temperature, Tch	200 °C
Mounting Temperature (30 Seconds)	260 °C
Storage Temperature	-40 to 150 °C

Operation of this device outside the parameter ranges given above may cause permanent damage. These are stress ratings only, and functional operation of the device at these conditions is not implied.

Recommended Operating Conditions

Parameter	Min	Typical	Max	Units
Vd		6		V
Id		1.3		A
Id_drive (Under RF Drive)		1.7		A
Vg		-0.55		V

Electrical specifications are measured at specified test conditions. Specifications are not guaranteed over all recommended operating conditions.

Electrical Specifications

Test conditions unless otherwise noted: 25°C, Vd = 6 V, Id = 1.3 A, Vg = -0.55 V Typical.

Parameter	Min	Typical	Max	Units
Operational Frequency Range	12.7		15.4	GHz
Gain	24	28		dB
Input Return Loss	10	15		dB
Output Return Loss	10	15		dB
Output Power @ Saturation		35		dBm
Output Power @ 1 dB Gain Compression	32	34		dBm
Output TOI @ Pout/Tone = 20 dBm	40	43		dBm
Gain Temperature Coefficient		-0.033		dB/°C
Power Temperature Coefficient		-0.005		dBm/°C

Specifications (cont.)

Thermal and Reliability Information

Parameter	Condition	Rating
Thermal Resistance, θ_{JC} , measured to back of package	Tbase = 70 °C	$\theta_{JC} = 5.76$ °C/W
Channel Temperature (Tch), and Median Lifetime (Tm)	Tbase = 70 °C, Vd = 6 V, Id = 1.3 A, Pdiss = 7.8 W	Tch = 115 °C Tm = 2.5 E+7 Hours
Channel Temperature (Tch), and Median Lifetime (Tm) Under RF Drive	Tbase = 70 °C, Vd = 6 V, Id = 1.7 A, Pout = 34.5 dBm, Pdiss = 7.38 W	Tch = 113 °C Tm = 3.1 E+7 Hours

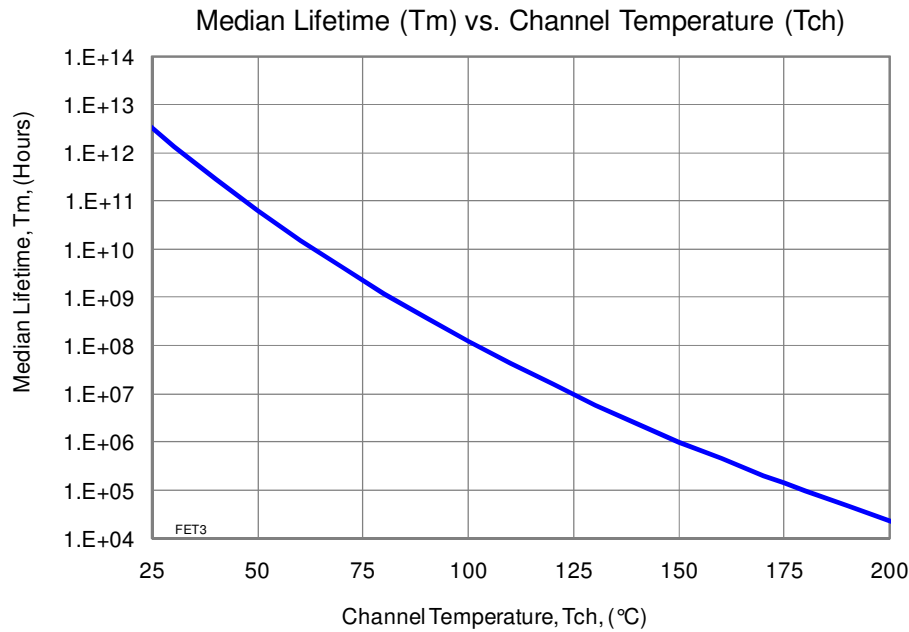

Typical Performance

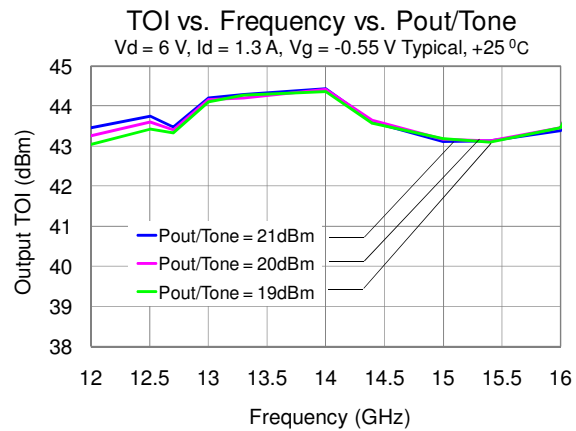
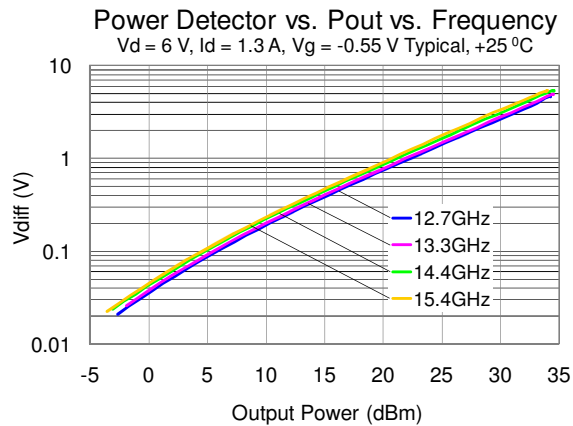
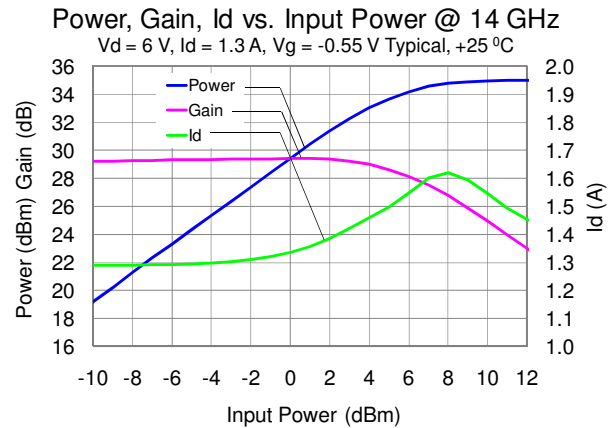
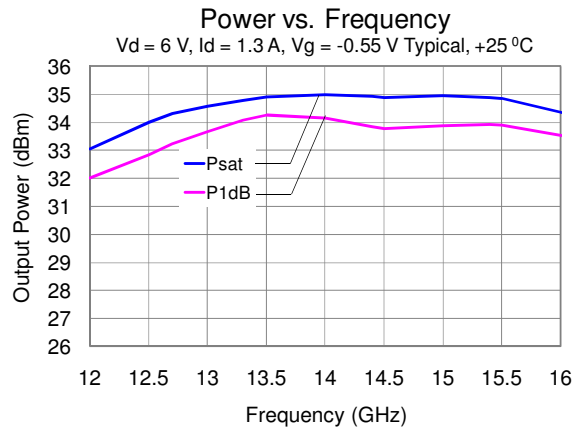
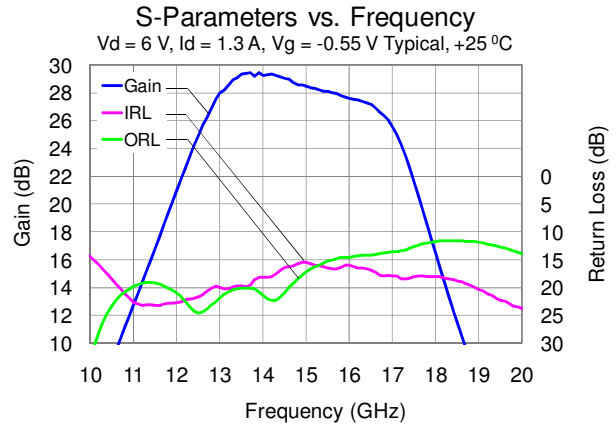
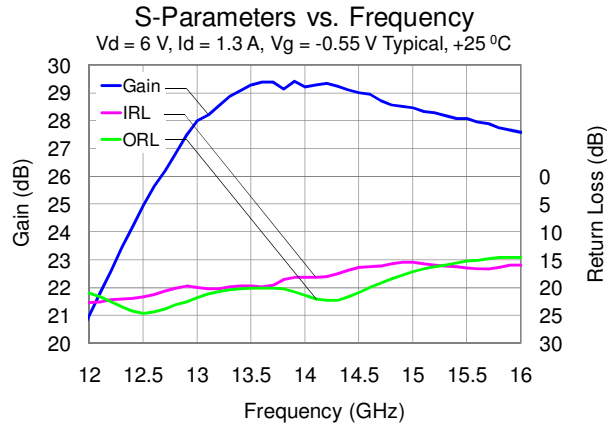

Typical Performance (cont.)

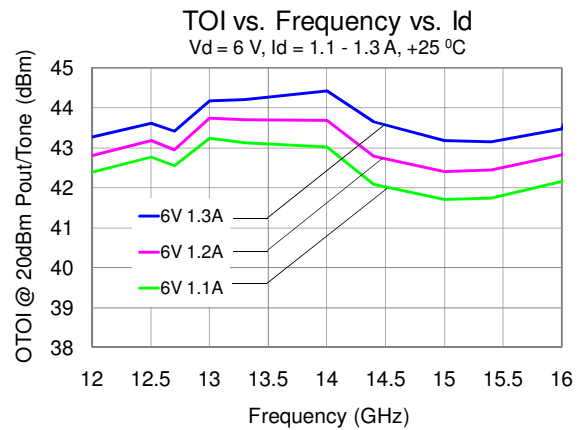
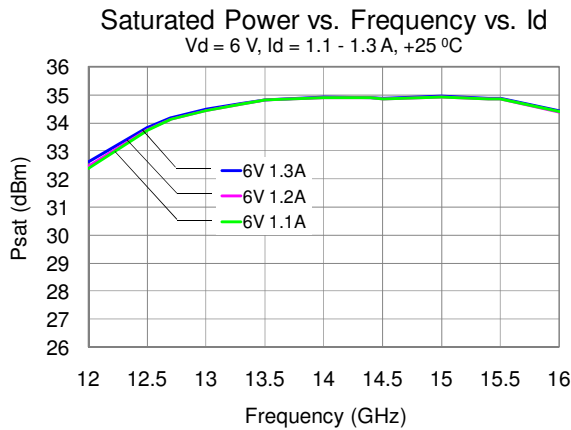
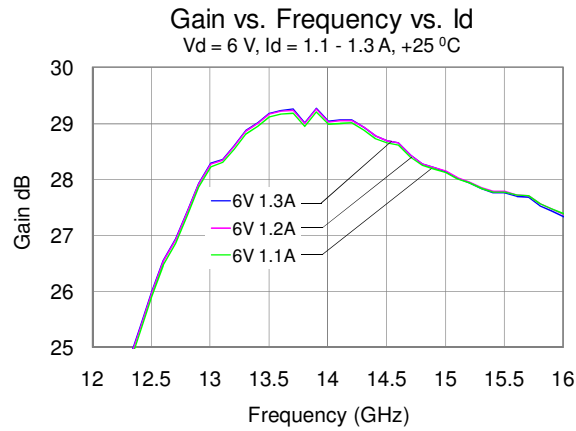
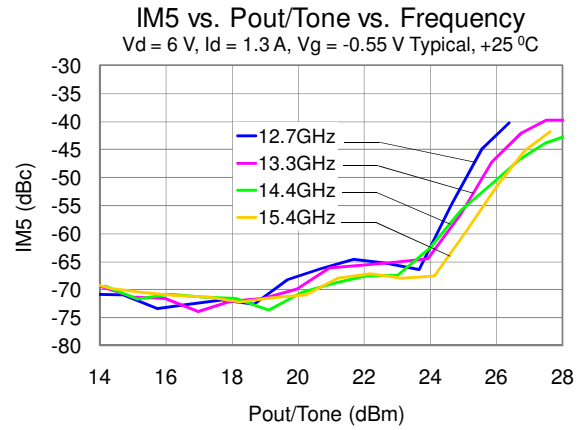
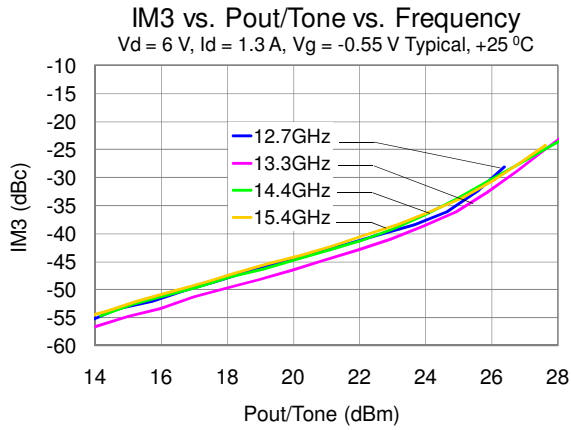

Application Circuit

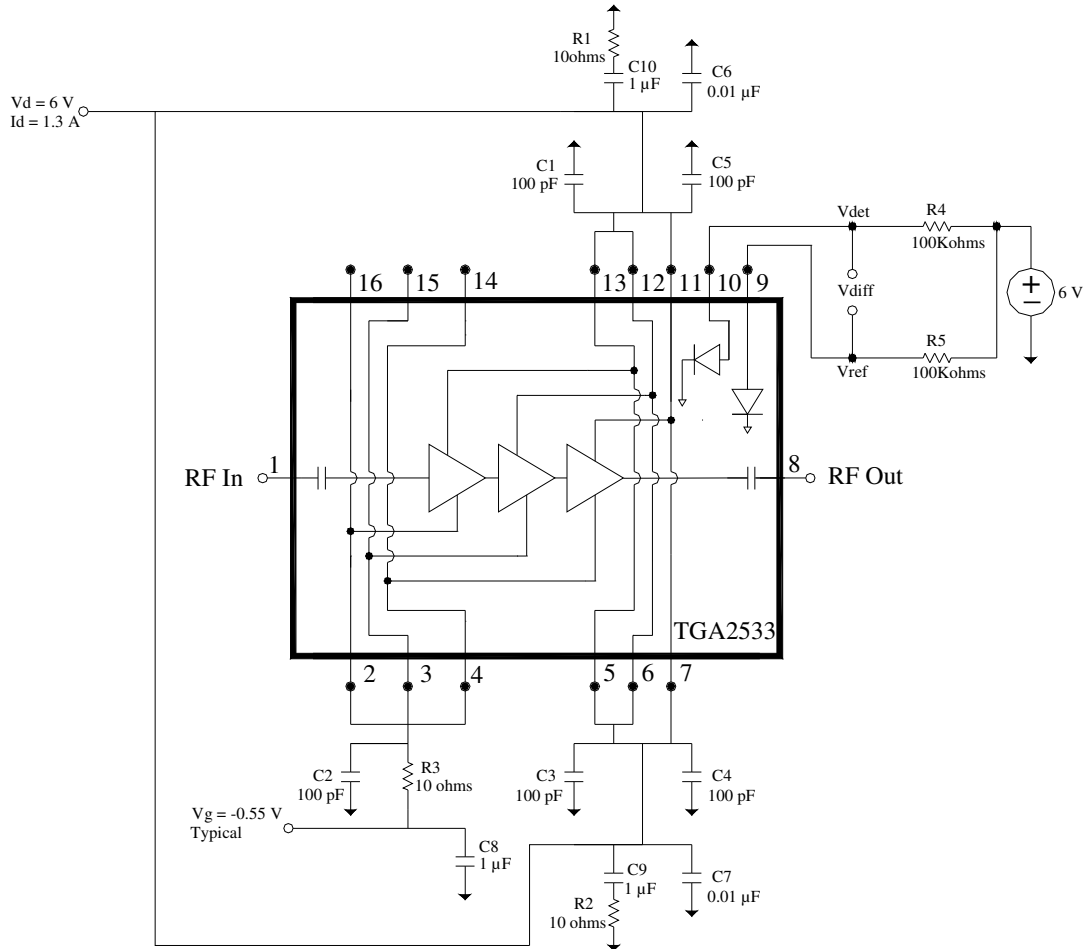

Vg can be biased from either side (pins 2,3,4 or pins 14,15,16), and the non-biased side can be left open.
Vd must be biased from both sides (pins 5, 6, 7 and pins 11,12,13).

Bias-up Procedure

Vg set to -1.5 V
Vd set to +6 V
Adjust Vg more positive until quiescent Id is 1.3A.
This will be ~ Vg = -0.55 V
Apply RF signal to RF Input

Bias-down Procedure

Turn off RF supply
Reduce Vg to -1.5V. Ensure Id ~ 0 mA
Turn Vd to 0 V
Turn Vg to 0 V

Bond Pad Description

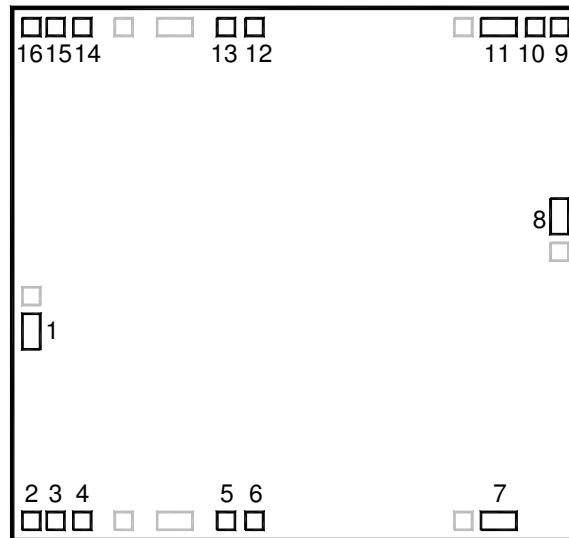

Bond Pad	Symbol	Description
1	RF IN	Input, matched to 50 ohms.
2,16	Vg1	Gate voltage for 1 st stage. See Note 1.
3,15	Vg2	Gate voltage for 2 nd stage. See Note 1.
4,14	Vg3	Gate voltage for 3 rd stage. See Note 1.
5,13	Vd1	Drain voltage for 1 st stage. See Note 2.
6,12	Vd2	Drain voltage for 2 nd stage. See Note 2.
7,11	Vd3	Drain voltage for 3 rd stage. See Note 2.
8	RF OUT	Output, matched to 50 ohms
9	Vdet	Detector diode output voltage. Varies with RF output power.
10	Vref	Reference diode output voltage.
	GND	Backside of die.

Notes:

- ESD protection included; Bias network is required; can be biased from either side (pins 2,3,4 or pins 14,15,16), and non-biased side can be left opened; see Application Circuit on page 6 as an example.
- Bias network is required; must be biased from both sides; see Application Circuit on page 6 as an example.

TGA2533

Ku-Band Power Amplifier

Assembly Drawing

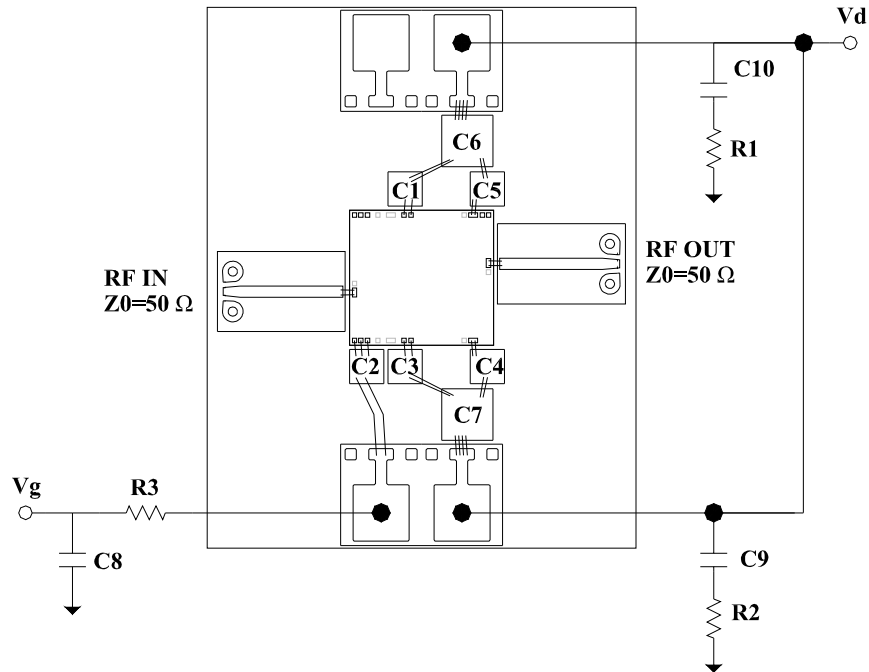

Bill of Material

Ref Des	Value	Description	Manufacturer	Part Number
C1, C2, C3, C4, C5	100 pF	Cap, 50V, 25%, Single Layer Cap	various	
C6, C7	0.01 uF	Cap, 50V, 10%, SMD	various	
C8, C9, C10	1 uF	Cap, 50V, 5%	various	
R1, R2, R3	10 Ohms	Res, 1/4W, 5%	various	

TGA2533

Ku-Band Power Amplifier

Mechanical Information

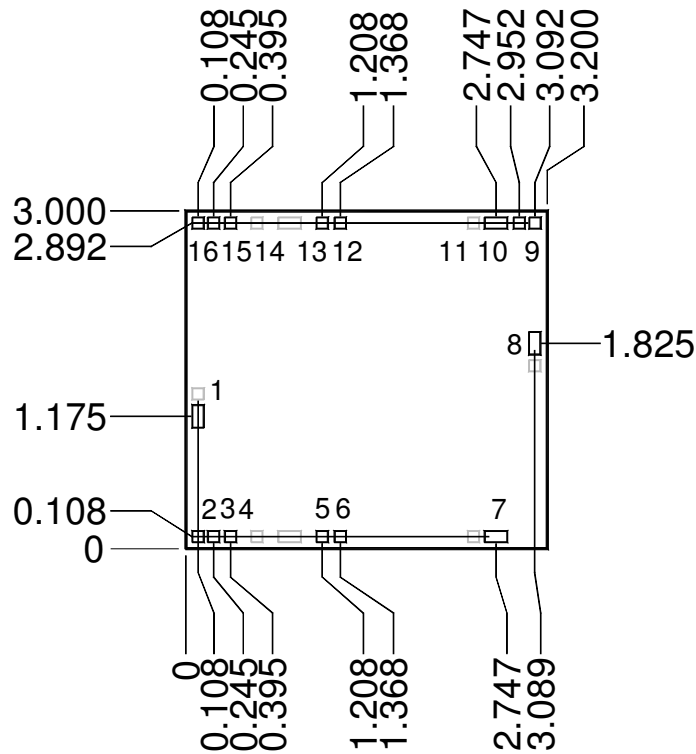

Unit: millimeters

Thickness: 0.10

Die x, y size tolerance: +/- 0.050

Chip edge to bond pad dimensions are shown to center of pad

Ground is backside of die

Bond Pad	Symbol	Pad Size
1	RF IN	0.100 x 0.200
2,16	Vg1	0.100 x 0.100
3,15	Vg2	0.100 x 0.100
4,14	Vg3	0.100 x 0.100
5,13	Vd1	0.100 x 0.100
6,12	Vd2	0.100 x 0.100
7,11	Vd3	0.100 x 0.200
8	RF OUT	0.100 x 0.200
9	Vdet	0.100 x 0.100
10	Vref	0.100 x 0.100

Product Compliance Information

ESD Information



Caution! ESD-Sensitive Device

ESD Rating: Class 0
Value: < 250V
Test: Human Body Model (HBM)
Standard: JEDEC Standard JESD22-A114

ECCN

US Department of Commerce 3A001.b.2.c

Solderability

This part is compliant with EU 2002/95/EC RoHS directive (Restrictions on the Use of Certain Hazardous Substances in Electrical and Electronic Equipment).

This product also has the following attributes:

- Lead Free
- Halogen Free (Chlorine, Bromine)
- Antimony Free
- TBBP-A (C₁₅H₁₂Br₄O₂) Free
- PFOS Free
- SVHC Free

Assembly Notes

Component placement and adhesive attachment assembly notes:

- Vacuum pencils and/or vacuum collets are the preferred method of pick up.
- Air bridges must be avoided during placement.
- The force impact is critical during auto placement.
- Organic attachment (i.e. epoxy) can be used in low-power applications.
- Curing should be done in a convection oven; proper exhaust is a safety concern.

Reflow process assembly notes:

- Use AuSn (80/20) solder and limit exposure to temperatures above 300°C to 3-4 minutes, maximum.
- An alloy station or conveyor furnace with reducing atmosphere should be used.
- Do not use any kind of flux.
- Coefficient of thermal expansion matching is critical for long-term reliability.
- Devices must be stored in a dry nitrogen atmosphere.

Interconnect process assembly notes:

- Thermosonic ball bonding is the preferred interconnect technique.
- Force, time, and ultrasonics are critical parameters.
- Aluminum wire should not be used.
- Devices with small pad sizes should be bonded with 0.0007-inch wire.

TGA2533

Ku-Band Power Amplifier



Contact Information

For the latest specifications, additional product information, worldwide sales and distribution locations, and information about TriQuint:

Web: www.triquint.com
Email: info-sales@tqs.com

Tel: +1.972.994.8465
Fax: +1.972.994.8504

For technical questions and application information:

Email: info-networks@tqs.com

Important Notice

The information contained herein is believed to be reliable. TriQuint makes no warranties regarding the information contained herein. TriQuint assumes no responsibility or liability whatsoever for any of the information contained herein. TriQuint assumes no responsibility or liability whatsoever for the use of the information contained herein. The information contained herein is provided "AS IS, WHERE IS" and with all faults, and the entire risk associated with such information is entirely with the user. All information contained herein is subject to change without notice. Customers should obtain and verify the latest relevant information before placing orders for TriQuint products. The information contained herein or any use of such information does not grant, explicitly or implicitly, to any party any patent rights, licenses, or any other intellectual property rights, whether with regard to such information itself or anything described by such information.

TriQuint products are not warranted or authorized for use as critical components in medical, life-saving, or life-sustaining applications, or other applications where a failure would reasonably be expected to cause severe personal injury or death.

Copyright © 2010 TriQuint Semiconductor, Inc. All rights reserved.

Mouser Electronics

Authorized Distributor

Click to View Pricing, Inventory, Delivery & Lifecycle Information:

[TriQuint:](#)

[TGA2533](#)