

Buck Pulse Width Modulator Stepdown Voltage Regulator

FEATURES

- Simple Single Inductor Buck PWM Stepdown Voltage Regulation
- Drives External PMOS Switch
- Contains UVLO Circuit
- Includes Pulse-by-Pulse Current Limit
- Low 50 μ A Sleep Mode Current

DESCRIPTION

The UC3573 is a Buck pulse width modulator which steps down and regulates a positive input voltage. The chip is optimized for use in a single inductor buck switching converter employing an external PMOS switch. The block diagram consists of a precision reference, an error amplifier configured for voltage mode operation, an oscillator, a PWM comparator with latching logic, and a 0.5A peak gate driver. The UC3573 includes an undervoltage lockout circuit to insure sufficient input supply voltage is present before any switching activity can occur, and a pulse-by-pulse current limit. Input current can be sensed and limited to a user determined maximum value. In addition, a sleep comparator interfaces to the UVLO circuit which turns the chip off when the input voltage is below the UVLO threshold. This reduces the supply current to only 50 μ A, making the UC3573 ideal for battery powered applications.

BLOCK DIAGRAM

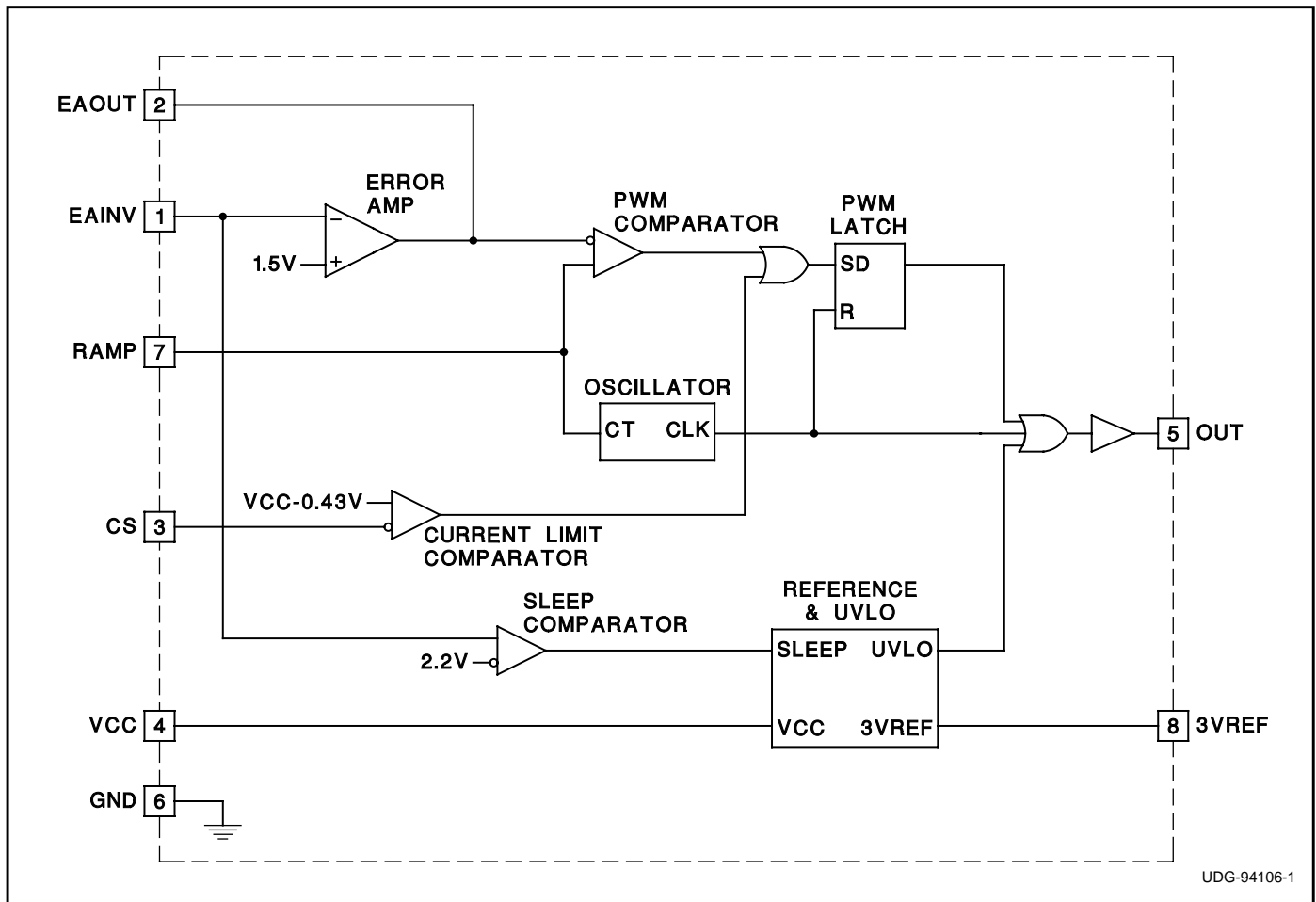

ABSOLUTE MAXIMUM RATINGS

VCC	35V
EAINV	-0.6V to VCC
I _{EAOUT}	25mA
RAMP	-0.3V to 4V
CS	-0.3V to VCC
I _{OUT}	-0.7A to 0.7A
I _{3VREF}	-15mA
Storage Temperature	-65°C to +150°C
Junction Temperature	-65°C to +150°C
Lead Temperature (Soldering, 10 sec.)	+300°C

Currents are positive into, negative out of the specified terminal. Consult Packaging Section of Databook for thermal limitations and considerations of packages.

CONNECTION DIAGRAMS

DIL-8, SOIC-8 (TOP VIEW)
J or N, D Packages

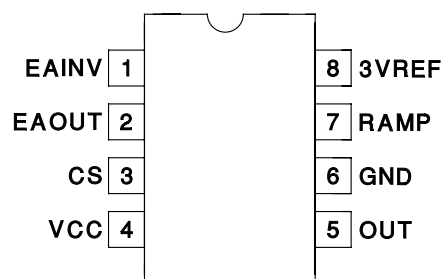

ELECTRICAL CHARACTERISTICS: Unless otherwise specified, these parameters apply for $T_A = -55^\circ\text{C}$ to $+125^\circ\text{C}$ for the UC1573, -40°C to $+85^\circ\text{C}$ for the UC2573, and 0°C to $+70^\circ\text{C}$ for the UC3573, $V_{CC} = 5\text{V}$, $C_T = 680\text{pF}$, $T_A = T_J$.

PARAMETER	TEST CONDITIONS	MIN	TYP	MAX	UNITS
Reference Section					
3VREF		2.94	3	3.06	V
Line Regulation	$V_{CC} = 4.75$ to 30V		1	10	mV
Load Regulation	$I_{3VREF} = 0$ to -5mA		1	10	mV
Oscillator Section					
Frequency	$V_{CC} = 5\text{V}$, 30V	85	100	115	kHz
Error Amp Section					
EAINV	EAOUT = 2V	1.45	1.5	1.55	V
I _{EAINV}	EAOUT = 2V		-0.2	-1	μA
AVOL	EAOUT = 0.5V to 3V	65	90		dB
EAOUT High	EAINV = 1.4V	3.6	4	4.4	V
EAOUT Low	EAINV = 1.6V		0.1	0.2	V
I _{EAOUT}	EAINV = 1.4V , EAOUT = 2V	-350	-500		μA
	EAINV = 1.6V , EAOUT = 2V	7	20		mA
Unity Gain Bandwidth	$T_J = 25^\circ\text{C}$, $F = 10\text{kHz}$	0.6	1		MHz
Current Sense Comparator Section					
Threshold (referred to VCC)		-0.39	-0.43	-0.47	V
Input Bias Current	CS = VCC		150	800	nA
CS Propagation Delay			400		ns
Gate Drive Output Section					
OUT High Saturation	I _{OUT} = 0		0	0.3	V
	I _{OUT} = -10mA		0.7	1.5	V
	I _{OUT} = -100mA		1.5	2.5	V
OUT Low Saturation	I _{OUT} = 10mA		0.1	0.4	V
	I _{OUT} = 100mA		1.5	2.2	V
Rise Time	$T_J = 25^\circ\text{C}$, $C_{LOAD} = 1\text{nF} + 3.3\text{ Ohms}$		30	80	ns
Fall Time	$T_J = 25^\circ\text{C}$, $C_{LOAD} = 1\text{nF} + 3.3\text{ Ohms}$		30	80	ns
Pulse Width Modulator Section					
Maximum Duty Cycle	EAINV = 1.4V		92	96	%
Minimum Duty Cycle	EAINV = 1.6V			0	%
Modulator Gain	EAOUT = 1.5V to 2.5V	25	35	45	%/V
Undervoltage Lockout Section					
Start Threshold		3.5	4.2	4.5	V
Hysteresis		100	200	300	mV

ELECTRICAL CHARACTERISTICS: Unless otherwise specified, these parameters apply for $T_A = -55^\circ\text{C}$ to $+125^\circ\text{C}$ for the UC1573, -40°C to $+85^\circ\text{C}$ for the UC2573, and 0°C to $+70^\circ\text{C}$ for the UC3573, $V_{CC} = 5\text{V}$, $C_T = 680\text{pF}$, $T_A = T_J$.

PARAMETER	TEST CONDITIONS	MIN	TYP	MAX	UNITS
Sleep Mode Section					
Threshold		1.8	2.2	2.6	V
Supply Current Section					
I_{VCC}	$V_{CC} = 30\text{V}$		9	12	mA
I_{VCC}	$V_{CC} = 30\text{V}, E_{AINV} = 3\text{V}$		50	150	A

PIN DESCRIPTIONS

3VREF: Precision 3V reference. Bypass with 100nF capacitor.

CS: Peak current limit sense pin. Senses the current across a current sense resistor placed between V_{CC} and source of the PMOS Buck switch. OUT will be held high (PMOS buck switch off) if $V_{CC} - CS$ exceeds 0.4V.

EAINV: Inverting input to error amplifier. VOUT sense feedback connected to this pin. The non-inverting input of the error amplifier is internally connected to:

$$\frac{3V_{REF}}{2} \text{ Volts.}$$

Connecting the EAINV pin to an external voltage greater than 2.6V commands the chip to go into a low current sleep mode.

EAOUT: Output of error amplifier. Use EAOUT and EAINV for loop compensation components.

GND: Circuit Ground.

OUT: Gate drive for external PMOS switch connected between V_{CC} and the flyback inductor. OUT drives the gate of the PMOS switch between V_{CC} and GND.

RAMP: Oscillator and ramp for pulse width modulator. Frequency is set by a capacitor to GND by the equation

$$F = \frac{1}{15k C_{RAMP}}$$

Recommended operating frequency range is 10kHz to 200kHz.

VCC: Input voltage supply to chip. Range is 4.75V to 30V. Bypass with a 1 F capacitor.

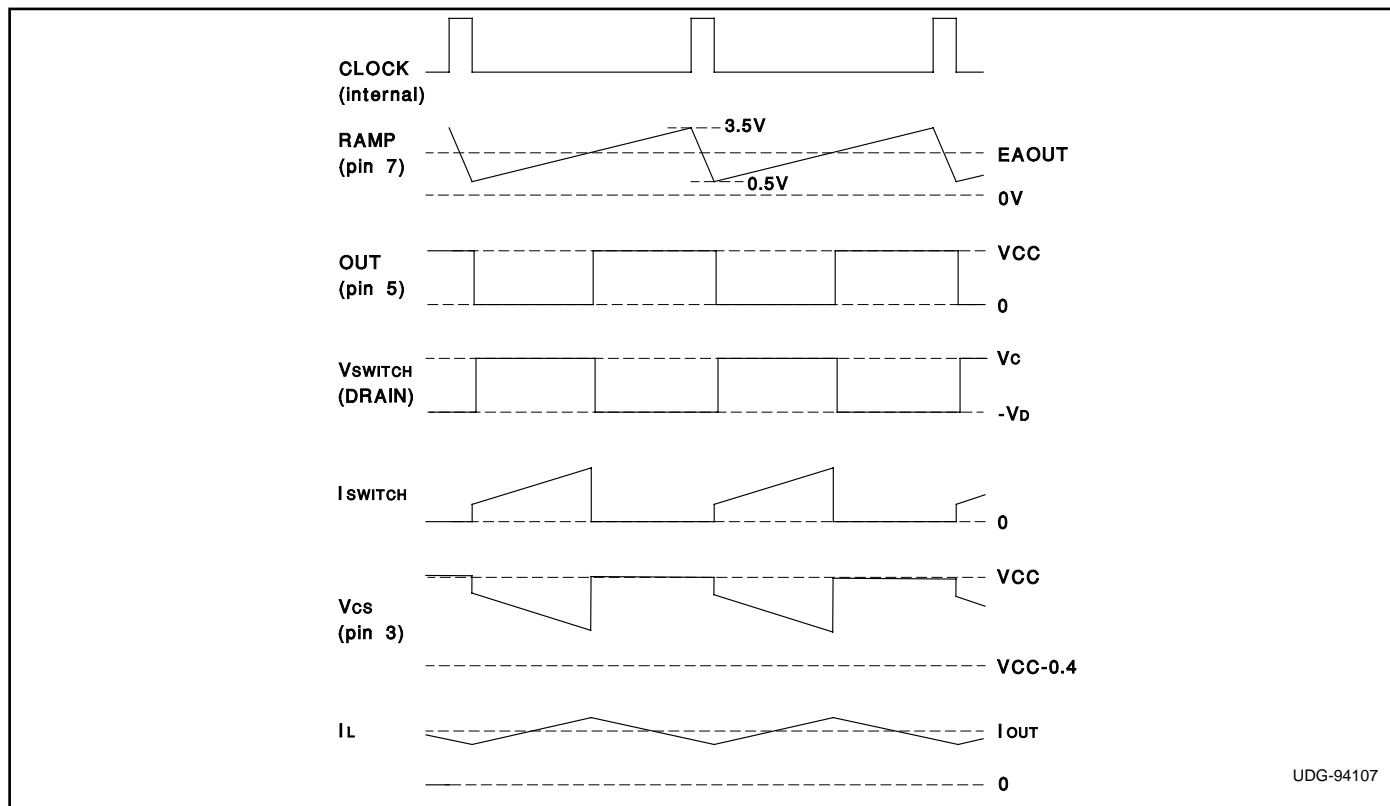

Typical Waveforms.

TYPICAL APPLICATION: 12V TO 5V BUCK CONVERTER

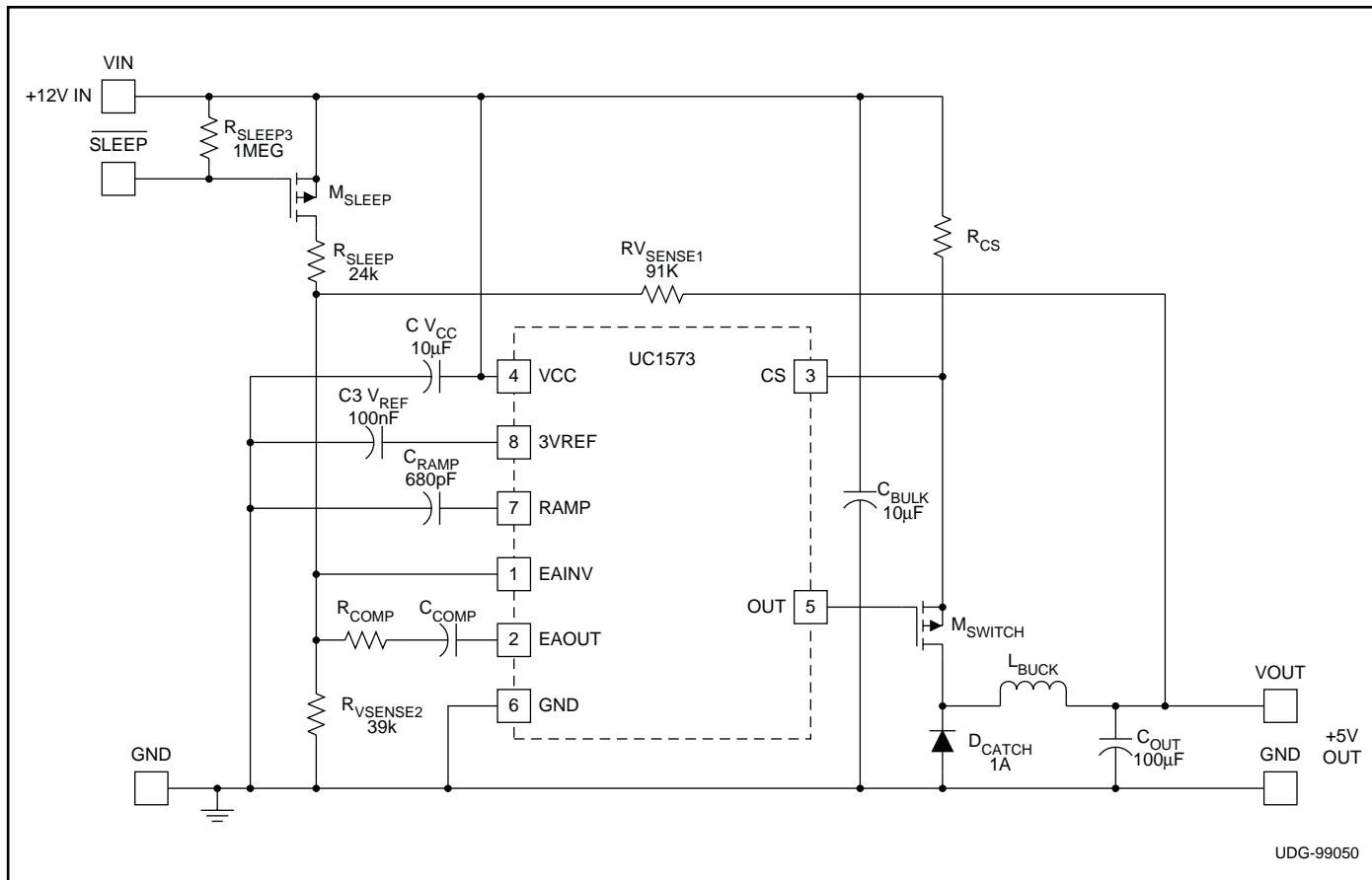

PACKAGING INFORMATION

Orderable Device	Status ⁽¹⁾	Package Type	Package Drawing	Pins	Package Qty	Eco Plan ⁽²⁾	Lead/Ball Finish	MSL Peak Temp ⁽³⁾
UC1573J	OBSOLETE	CDIP	J	8		TBD	Call TI	Call TI
UC2573D	ACTIVE	SOIC	D	8	75	Green (RoHS & no Sb/Br)	CU NIPDAU	Level-1-260C-UNLIM
UC2573DG4	ACTIVE	SOIC	D	8	75	Green (RoHS & no Sb/Br)	CU NIPDAU	Level-1-260C-UNLIM
UC2573DTR	ACTIVE	SOIC	D	8	2500	Green (RoHS & no Sb/Br)	CU NIPDAU	Level-1-260C-UNLIM
UC2573DTRG4	ACTIVE	SOIC	D	8	2500	Green (RoHS & no Sb/Br)	CU NIPDAU	Level-1-260C-UNLIM
UC2573N	ACTIVE	PDIP	P	8	50	Green (RoHS & no Sb/Br)	CU NIPDAU	N / A for Pkg Type
UC2573NG4	ACTIVE	PDIP	P	8	50	Green (RoHS & no Sb/Br)	CU NIPDAU	N / A for Pkg Type
UC3573D	ACTIVE	SOIC	D	8	75	Green (RoHS & no Sb/Br)	CU NIPDAU	Level-1-260C-UNLIM
UC3573DG4	ACTIVE	SOIC	D	8	75	Green (RoHS & no Sb/Br)	CU NIPDAU	Level-1-260C-UNLIM
UC3573DTR	ACTIVE	SOIC	D	8	2500	Green (RoHS & no Sb/Br)	CU NIPDAU	Level-1-260C-UNLIM
UC3573DTRG4	ACTIVE	SOIC	D	8	2500	Green (RoHS & no Sb/Br)	CU NIPDAU	Level-1-260C-UNLIM
UC3573N	ACTIVE	PDIP	P	8	50	Green (RoHS & no Sb/Br)	CU NIPDAU	N / A for Pkg Type
UC3573NG4	ACTIVE	PDIP	P	8	50	Green (RoHS & no Sb/Br)	CU NIPDAU	N / A for Pkg Type

⁽¹⁾ The marketing status values are defined as follows:

ACTIVE: Product device recommended for new designs.

LIFEBUY: TI has announced that the device will be discontinued, and a lifetime-buy period is in effect.

NRND: Not recommended for new designs. Device is in production to support existing customers, but TI does not recommend using this part in a new design.

PREVIEW: Device has been announced but is not in production. Samples may or may not be available.

OBSOLETE: TI has discontinued the production of the device.

⁽²⁾ Eco Plan - The planned eco-friendly classification: Pb-Free (RoHS), Pb-Free (RoHS Exempt), or Green (RoHS & no Sb/Br) - please check <http://www.ti.com/productcontent> for the latest availability information and additional product content details.

TBD: The Pb-Free/Green conversion plan has not been defined.

Pb-Free (RoHS): TI's terms "Lead-Free" or "Pb-Free" mean semiconductor products that are compatible with the current RoHS requirements for all 6 substances, including the requirement that lead not exceed 0.1% by weight in homogeneous materials. Where designed to be soldered at high temperatures, TI Pb-Free products are suitable for use in specified lead-free processes.

Pb-Free (RoHS Exempt): This component has a RoHS exemption for either 1) lead-based flip-chip solder bumps used between the die and package, or 2) lead-based die adhesive used between the die and leadframe. The component is otherwise considered Pb-Free (RoHS compatible) as defined above.

Green (RoHS & no Sb/Br): TI defines "Green" to mean Pb-Free (RoHS compatible), and free of Bromine (Br) and Antimony (Sb) based flame retardants (Br or Sb do not exceed 0.1% by weight in homogeneous material)

⁽³⁾ MSL, Peak Temp. -- The Moisture Sensitivity Level rating according to the JEDEC industry standard classifications, and peak solder temperature.

Important Information and Disclaimer:The information provided on this page represents TI's knowledge and belief as of the date that it is provided. TI bases its knowledge and belief on information provided by third parties, and makes no representation or warranty as to the accuracy of such information. Efforts are underway to better integrate information from third parties. TI has taken and continues to take reasonable steps to provide representative and accurate information but may not have conducted destructive testing or chemical analysis on incoming materials and chemicals. TI and TI suppliers consider certain information to be proprietary, and thus CAS numbers and other limited

information may not be available for release.

In no event shall TI's liability arising out of such information exceed the total purchase price of the TI part(s) at issue in this document sold by TI to Customer on an annual basis.

TAPE AND REEL INFORMATION



QUADRANT ASSIGNMENTS FOR PIN 1 ORIENTATION IN TAPE



*All dimensions are nominal

Device	Package Type	Package Drawing	Pins	SPQ	Reel Diameter (mm)	Reel Width W1 (mm)	A0 (mm)	B0 (mm)	K0 (mm)	P1 (mm)	W (mm)	Pin1 Quadrant
UC2573DTR	SOIC	D	8	2500	330.0	12.4	6.4	5.2	2.1	8.0	12.0	Q1
UC3573DTR	SOIC	D	8	2500	330.0	12.4	6.4	5.2	2.1	8.0	12.0	Q1

TAPE AND REEL BOX DIMENSIONS



*All dimensions are nominal

Device	Package Type	Package Drawing	Pins	SPQ	Length (mm)	Width (mm)	Height (mm)
UC2573DTR	SOIC	D	8	2500	346.0	346.0	29.0
UC3573DTR	SOIC	D	8	2500	346.0	346.0	29.0

D (R-PDSO-G8)

PLASTIC SMALL-OUTLINE PACKAGE

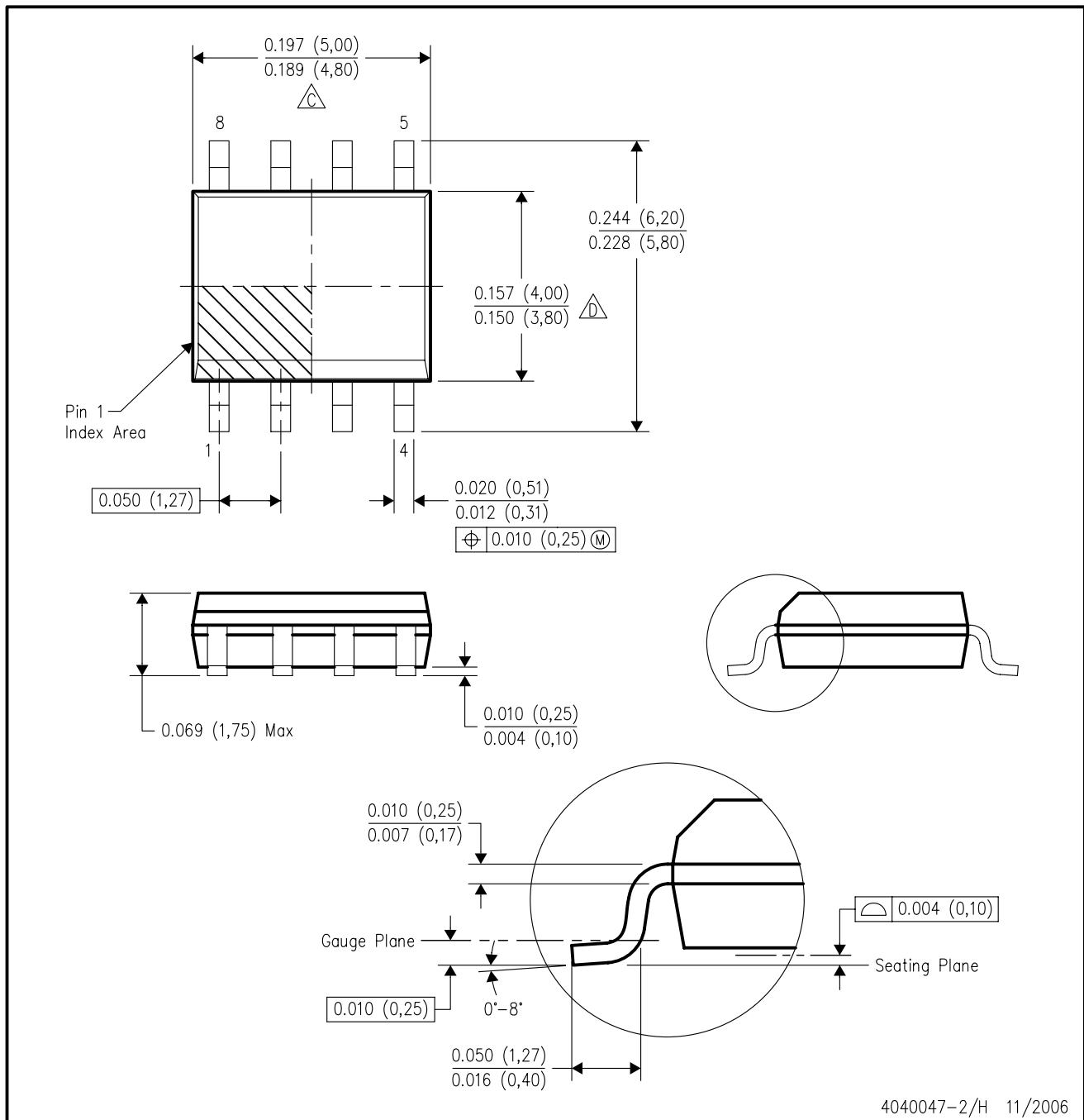

- NOTES:
- A. All linear dimensions are in inches (millimeters).
 - B. This drawing is subject to change without notice.
 - C. Body length does not include mold flash, protrusions, or gate burrs. Mold flash, protrusions, or gate burrs shall not exceed .006 (0,15) per end.
 - D. Body width does not include interlead flash. Interlead flash shall not exceed .017 (0,43) per side.
 - E. Reference JEDEC MS-012 variation AA.

P (R-PDIP-T8)

PLASTIC DUAL-IN-LINE



- NOTES: A. All linear dimensions are in inches (millimeters).
 B. This drawing is subject to change without notice.
 C. Falls within JEDEC MS-001

For the latest package information, go to http://www.ti.com/sc/docs/package/pkg_info.htm



IMPORTANT NOTICE

Texas Instruments Incorporated and its subsidiaries (TI) reserve the right to make corrections, modifications, enhancements, improvements, and other changes to its products and services at any time and to discontinue any product or service without notice. Customers should obtain the latest relevant information before placing orders and should verify that such information is current and complete. All products are sold subject to TI's terms and conditions of sale supplied at the time of order acknowledgment.

TI warrants performance of its hardware products to the specifications applicable at the time of sale in accordance with TI's standard warranty. Testing and other quality control techniques are used to the extent TI deems necessary to support this warranty. Except where mandated by government requirements, testing of all parameters of each product is not necessarily performed.

TI assumes no liability for applications assistance or customer product design. Customers are responsible for their products and applications using TI components. To minimize the risks associated with customer products and applications, customers should provide adequate design and operating safeguards.

TI does not warrant or represent that any license, either express or implied, is granted under any TI patent right, copyright, mask work right, or other TI intellectual property right relating to any combination, machine, or process in which TI products or services are used. Information published by TI regarding third-party products or services does not constitute a license from TI to use such products or services or a warranty or endorsement thereof. Use of such information may require a license from a third party under the patents or other intellectual property of the third party, or a license from TI under the patents or other intellectual property of TI.

Reproduction of TI information in TI data books or data sheets is permissible only if reproduction is without alteration and is accompanied by all associated warranties, conditions, limitations, and notices. Reproduction of this information with alteration is an unfair and deceptive business practice. TI is not responsible or liable for such altered documentation. Information of third parties may be subject to additional restrictions.

Resale of TI products or services with statements different from or beyond the parameters stated by TI for that product or service voids all express and any implied warranties for the associated TI product or service and is an unfair and deceptive business practice. TI is not responsible or liable for any such statements.

TI products are not authorized for use in safety-critical applications (such as life support) where a failure of the TI product would reasonably be expected to cause severe personal injury or death, unless officers of the parties have executed an agreement specifically governing such use. Buyers represent that they have all necessary expertise in the safety and regulatory ramifications of their applications, and acknowledge and agree that they are solely responsible for all legal, regulatory and safety-related requirements concerning their products and any use of TI products in such safety-critical applications, notwithstanding any applications-related information or support that may be provided by TI. Further, Buyers must fully indemnify TI and its representatives against any damages arising out of the use of TI products in such safety-critical applications.

TI products are neither designed nor intended for use in military/aerospace applications or environments unless the TI products are specifically designated by TI as military-grade or "enhanced plastic." Only products designated by TI as military-grade meet military specifications. Buyers acknowledge and agree that any such use of TI products which TI has not designated as military-grade is solely at the Buyer's risk, and that they are solely responsible for compliance with all legal and regulatory requirements in connection with such use.

TI products are neither designed nor intended for use in automotive applications or environments unless the specific TI products are designated by TI as compliant with ISO/TS 16949 requirements. Buyers acknowledge and agree that, if they use any non-designated products in automotive applications, TI will not be responsible for any failure to meet such requirements.

Following are URLs where you can obtain information on other Texas Instruments products and application solutions:

Products

Amplifiers	amplifier.ti.com
Data Converters	dataconverter.ti.com
DSP	dsp.ti.com
Clocks and Timers	www.ti.com/clocks
Interface	interface.ti.com
Logic	logic.ti.com
Power Mgmt	power.ti.com
Microcontrollers	microcontroller.ti.com
RFID	www.ti-rfid.com
RF/IF and ZigBee® Solutions	www.ti.com/lprf

Applications

Audio	www.ti.com/audio
Automotive	www.ti.com/automotive
Broadband	www.ti.com/broadband
Digital Control	www.ti.com/digitalcontrol
Medical	www.ti.com/medical
Military	www.ti.com/military
Optical Networking	www.ti.com/opticalnetwork
Security	www.ti.com/security
Telephony	www.ti.com/telephony
Video & Imaging	www.ti.com/video
Wireless	www.ti.com/wireless

Mailing Address: Texas Instruments, Post Office Box 655303, Dallas, Texas 75265
Copyright © 2008, Texas Instruments Incorporated