

BC856A THRU BC858C

PNP Small Signal Transistor 200mW

Features

- Lead Free Finish/RoHS Compliant ("P" Suffix designates RoHS Compliant. See ordering information)
- Epoxy meets UL 94 V-0 flammability rating
- Moisture Sensitivity Level 1
- Ideally Suited for Automatic Insertion
- 150°C Junction Temperature
- For Switching and AF Amplifier Applications
- Halogen free available upon request by adding suffix "-HF"

Mechanical Data

- Case: SOT-23, Molded Plastic
- Terminals: Solderable per MIL-STD-202, Method 208
- Polarity: See Diagram
- Weight: 0.008 grams (approx.)

Marking Code (Note 2)

Type	Marking	Type	Marking
BC856A	3A	BC857C	3G
BC856B	3B	BC858A	3J
BC857A	3E	BC858B	3K
BC857B	3F	BC858C	3L

Maximum Ratings @ 25°C Unless Otherwise Specified

Charateristic	Symbol	Value	Unit
Collector-Base Voltage	BC856	-80	V
	BC857	-50	
	BC858	-30	
Collector-Emitter Voltage	BC856	-65	V
	BC857	-45	
	BC858	-30	
Emitter-Base Voltage	V_{EBO}	-5.0	V
Collector Current	I_C	-100	mA
Peak Collector Current	I_{CM}	-200	mA
Peak Emitter Current	I_{EM}	-200	mA
Power Dissipation@ $T_s=50^\circ\text{C}$ (Note1)	P_d	200	mW
Operating & Storage Temperature	T_j, T_{STG}	-55~150	°C

- Note:**
1. Package mounted on ceramic substrate 0.7mm X 2.5cm² area.
 2. Current gain subgroup " C " is not available for BC856

SOT-23

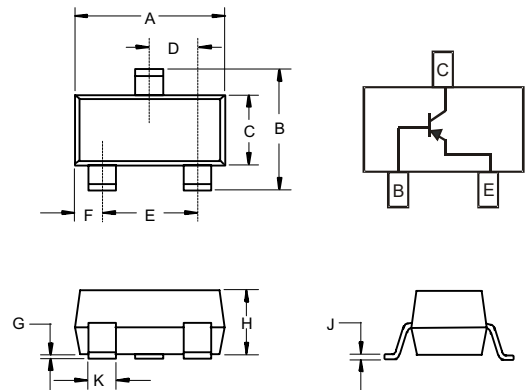

DIM	INCHES		MM		NOTE
	MIN	MAX	MIN	MAX	
A	.110	.120	2.80	3.04	
B	.083	.104	2.10	2.64	
C	.047	.055	1.20	1.40	
D	.035	.041	.89	1.03	
E	.070	.081	1.78	2.05	
F	.018	.024	.45	.60	
G	.0005	.0039	.013	.100	
H	.035	.044	.89	1.12	
J	.003	.007	.085	.180	
K	.015	.020	.37	.51	

Suggested Solder Pad Layout

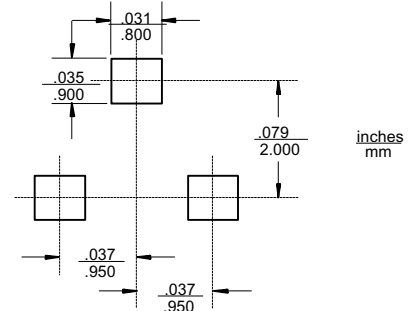

BC856A thru BC858C

Electrical Characteristics @ T_A = 25°C unless otherwise specified

Characteristic	Symbol	Min	Typ	Max	Unit	Test Condition	
Collector-Base Breakdown Voltage (Note 3)	BC856 BC857 BC858 V _{(BR)CBO}	-80 -50 -30	— — —	— — —	V	I _C = 10μA, I _B = 0	
Collector-Emitter Breakdown Voltage (Note 3)	BC856 BC857 BC858 V _{(BR)CEO}	-65 -45 -30	— — —	— — —	V	I _C = 10mA, I _B = 0	
Emitter-Base Breakdown Voltage (Note 3)	V _{(BR)EBO}	-5	—	—	V	I _E = 1μA, I _C = 0	
H-Parameters							
Small Signal Current Gain	Current Gain Group A B C	h _{fe} h _{fe} h _{fe}	— — —	200 330 600	— — —	V _{CE} = -5.0V, I _C = -2.0mA, f = 1.0kHz	
Input Impedance	Current Gain Group A B C	h _{ie} h _{ie} h _{ie}	— — —	2.7 4.5 8.7	kΩ kΩ kΩ		
Output Admittance	Current Gain Group A B C	h _{oe} h _{oe} h _{oe}	— — —	18 30 60	μS μS μS		
Reverse Voltage Transfer Ratio	Current Gain Group A B C	h _{re} h _{re} h _{re}	— — —	1.5x10 ⁻⁴ 2x10 ⁻⁴ 3x10 ⁻⁴	— — —		
DC Current Gain (Note 3)	Current Gain Group A B C	h _{FE}	125 220 420	180 290 520	250 475 800		V _{CE} = -5.0V, I _C = -2.0mA
Thermal Resistance, Junction to Substrate Backside	R _{θJSB}	—	—	320	°C/W		Note 1
Thermal Resistance, Junction to Ambient	R _{θJA}	—	—	625	°C/W	Note 1	
Collector-Emitter Saturation Voltage (Note 3)	V _{CE(SAT)}	—	-75 -250	-300 -650	mV	I _C = -10mA, I _B = -0.5mA I _C = -100mA, I _B = -5.0mA	
Base-Emitter Saturation Voltage (Note 3)	V _{BE(SAT)}	—	-700 -850	—	mV	I _C = -10mA, I _B = -0.5mA I _C = -100mA, I _B = -5.0mA	
Base-Emitter Voltage (Note 3)	V _{BE(ON)}	-600 —	-650 —	-750 -820	mV	V _{CE} = -5.0V, I _C = -2.0mA V _{CE} = -5.0V, I _C = -10mA	
Collector-Cutoff Current (Note 3)	BC856 BC857 BC858 I _{CES} I _{CES} I _{CES} I _{CBO} I _{CBO}	— — — — —	— — — — —	-15 -15 -15 -15 -4.0	nA nA nA nA μA	V _{CE} = -80V V _{CE} = -50V V _{CE} = -30V V _{CB} = -30V V _{CB} = -30V, T _A = 150°C	
Gain Bandwidth Product	f _T	100	200	—	MHz	V _{CE} = -5.0V, I _C = -10mA, f = 100MHz	
Collector-Base Capacitance	C _{CB0}	—	3	—	pF	V _{CB} = -10V, f = 1.0MHz	
Noise Figure	NF	—	2	10	dB	V _{CE} = -5.0V, I _C = 200μA, R _S = 2kΩ, f = 1kHz, Δf = 200Hz	

- Notes:
1. Package mounted on ceramic substrate 0.7mm x 2.5cm² area.
 2. Current gain subgroup "C" is not available for BC856.
 3. Short duration pulse test to minimize self-heating effect.

BC856A thru BC858C

Static Characteristic

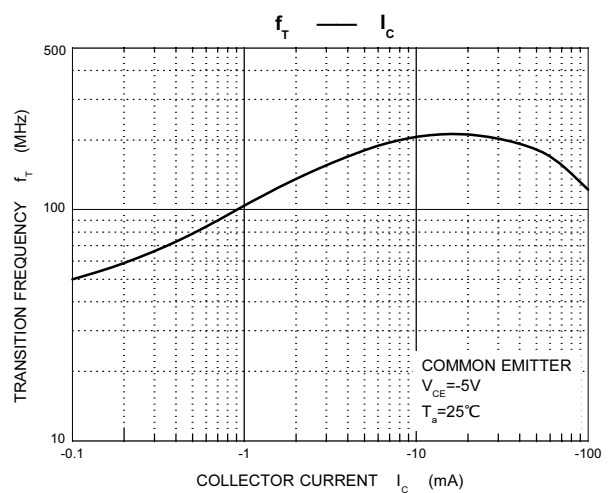
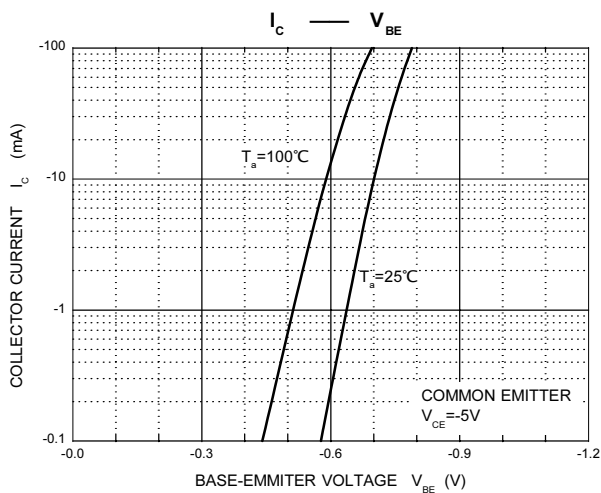
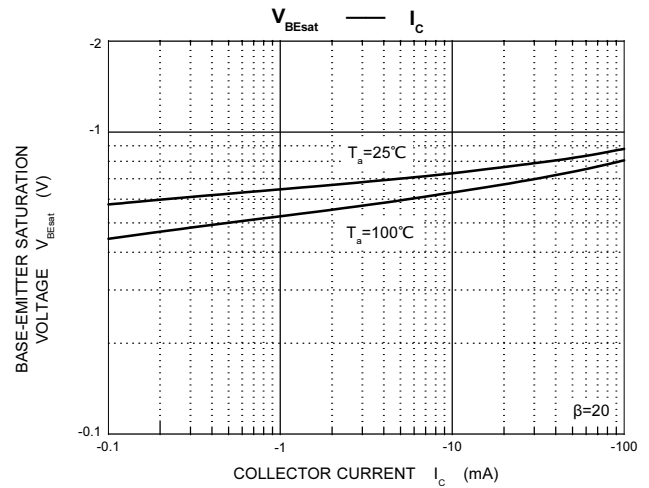
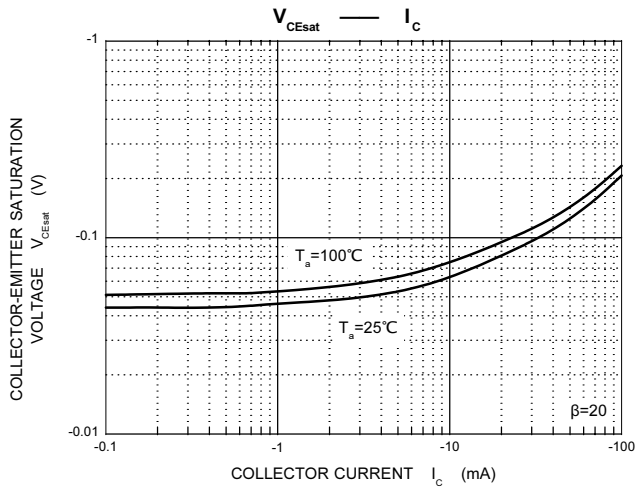
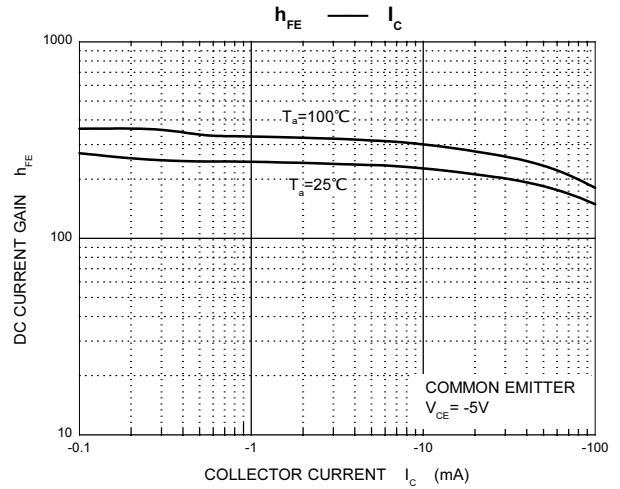
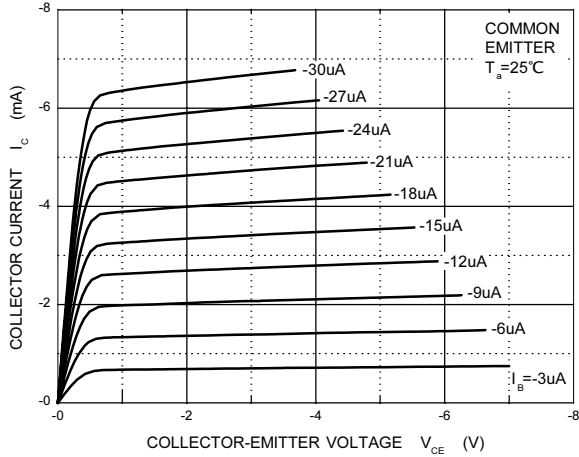

BC856A thru BC858C

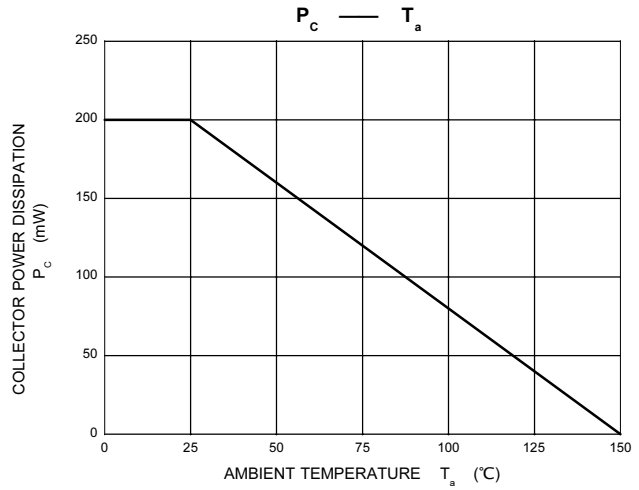
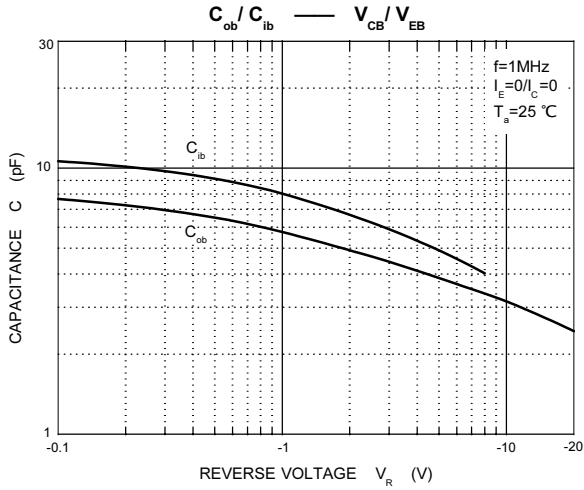



Micro Commercial Components

Ordering Information :

Device	Packing
Part Number-TP	Tape&Reel; 3Kpcs/Reel

Note : Adding "-HF" suffix for halogen free, eg. Part Number-TP-HF

IMPORTANT NOTICE

Micro Commercial Components Corp. reserves the right to make changes without further notice to any product herein to make corrections, modifications, enhancements, improvements, or other changes. **Micro Commercial Components Corp.** does not assume any liability arising out of the application or use of any product described herein; neither does it convey any license under its patent rights, nor the rights of others. The user of products in such applications shall assume all risks of such use and will agree to hold **Micro Commercial Components Corp.** and all the companies whose products are represented on our website, harmless against all damages.

LIFE SUPPORT

MCC's products are not authorized for use as critical components in life support devices or systems without the express written approval of Micro Commercial Components Corporation.

CUSTOMER AWARENESS

Counterfeiting of semiconductor parts is a growing problem in the industry. Micro Commercial Components (MCC) is taking strong measures to protect ourselves and our customers from the proliferation of counterfeit parts. MCC strongly encourages customers to purchase MCC parts either directly from MCC or from Authorized MCC Distributors who are listed by country on our web page cited below. Products customers buy either from MCC directly or from Authorized MCC Distributors are genuine parts, have full traceability, meet MCC's quality standards for handling and storage. **MCC will not provide any warranty coverage or other assistance for parts bought from Unauthorized Sources.** MCC is committed to combat this global problem and encourage our customers to do their part in stopping this practice by buying direct or from authorized distributors.

www.mccsemi.com