

# TLV271, TLV272, TLV274 FAMILY OF 550- $\mu$ A/Ch 3-MHz RAIL-TO-RAIL OUTPUT OPERATIONAL AMPLIFIERS

SLOS351D – MARCH 2001 – REVISED FEBRUARY 2004

- Rail-To-Rail Output
- Wide Bandwidth . . . 3 MHz
- High Slew Rate . . . 2.4 V/ $\mu$ s
- Supply Voltage Range . . . 2.7 V to 16 V
- Supply Current . . . 550  $\mu$ A/Channel
- Input Noise Voltage . . . 39 nV/ $\sqrt{\text{Hz}}$
- Input Bias Current . . . 1 pA
- Specified Temperature Range
  - 0°C to 70°C . . . Commercial Grade
  - 40°C to 125°C . . . Industrial Grade
- Ultrasmall Packaging
  - 5 Pin SOT-23 (TLV271)
  - 8 Pin MSOP (TLV272)
- Ideal Upgrade for TLC27x Family

Operational Amplifier

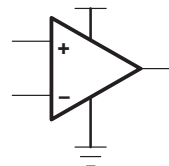

## description

The TLV27x takes the minimum operating supply voltage down to 2.7 V over the extended industrial temperature range while adding the rail-to-rail output swing feature. This makes it an ideal alternative to the TLC27x family for applications where rail-to-rail output swings are essential. The TLV27x also provides 3-MHz bandwidth from only 550  $\mu$ A.

Like the TLC27x, the TLV27x is fully specified for 5-V and  $\pm$ 5-V supplies. The maximum recommended supply voltage is 16 V, which allows the devices to be operated from a variety of rechargeable cells ( $\pm$ 8 V supplies down to  $\pm$ 1.35 V).

The CMOS inputs enable use in high-impedance sensor interfaces, with the lower voltage operation making an attractive alternative for the TLC27x in battery-powered applications.

All members are available in PDIP and SOIC with the singles in the small SOT-23 package, duals in the MSOP, and quads in the TSSOP package.

The 2.7-V operation makes it compatible with Li-Ion powered systems and the operating supply voltage range of many micropower microcontrollers available today including TI's MSP430.

SELECTION OF SIGNAL AMPLIFIER PRODUCTS†

DEVICE	V <sub>DD</sub> (V)	V <sub>IO</sub> ( $\mu$ V)	I <sub>q</sub> /Ch ( $\mu$ A)	I <sub>IB</sub> (pA)	GBW (MHz)	SR (V/ $\mu$ s)	SHUTDOWN	RAIL-TO-RAIL	SINGLES/DUALS/QUADS
TLV27x	2.7–16	500	550	1	3	2.4	—	O	S/D/Q
TLC27x	3–16	1100	675	1	1.7	3.6	—	—	S/D/Q
TLV237x	2.7–16	500	550	1	3	2.4	Yes	I/O	S/D/Q
TLC227x	4–16	300	1100	1	2.2	3.6	—	O	D/Q
TLV246x	2.7–6	150	550	1300	6.4	1.6	Yes	I/O	S/D/Q
TLV247x	2.7–6	250	600	2	2.8	1.5	Yes	I/O	S/D/Q
TLV244x	2.7–10	300	725	1	1.8	1.4	—	O	D/Q

† Typical values measured at 5 V, 25°C



Please be aware that an important notice concerning availability, standard warranty, and use in critical applications of Texas Instruments semiconductor products and disclaimers thereto appears at the end of this data sheet.

PRODUCTION DATA information is current as of publication date. Products conform to specifications per the terms of Texas Instruments standard warranty. Production processing does not necessarily include testing of all parameters.

 **TEXAS  
INSTRUMENTS**  
WWW.TI.COM

Copyright © 2001–2004, Texas Instruments Incorporated

# TLV271, TLV272, TLV274

## FAMILY OF 550- $\mu$ A/Ch 3-MHz RAIL-TO-RAIL OUTPUT OPERATIONAL AMPLIFIERS

SLOS351D – MARCH 2001 – REVISED FEBRUARY 2004

FAMILY PACKAGE TABLE

DEVICE	NUMBER OF CHANNELS	PACKAGE TYPES					SHUTDOWN	UNIVERSAL EVM BOARD
		PDIP	SOIC	SOT-23	TSSOP	MSOP		
TLV271	1	8	8	5	—	—	—	Refer to the EVM Selection Guide (Lit# SLOU060)
TLV272	2	8	8	—	—	8	—	
TLV274	4	14	14	—	14	—	—	

TLV271 AVAILABLE OPTIONS

T <sub>A</sub>	V <sub>IO</sub> MAX AT 25°C	PACKAGED DEVICES			
		SMALL OUTLINE (D) <sup>†</sup>	SOT-23		PLASTIC DIP (P)
			(DBV) <sup>‡</sup>	SYMBOL	
0°C to 70°C	5 mV	TLV271CD	TLV271CDBV	VBHC	—
–40°C to 125°C		TLV271ID	TLV271IDBV	VBHI	TLV271IP

<sup>†</sup> This package is available taped and reeled. To order this packaging option, add an R suffix to the part number (e.g., TLV271IDR).

<sup>‡</sup> This package is only available taped and reeled. For standard quantities (3,000 pieces per reel), add an R suffix (e.g., TLV270IDBVR). For smaller quantities (250 pieces per mini-reel), add a T suffix to the part number (e.g., TLV270IDBVT).

TLV272 AVAILABLE OPTIONS

T <sub>A</sub>	V <sub>IO</sub> MAX AT 25°C	PACKAGED DEVICES			
		SMALL OUTLINE (D) <sup>§</sup>	MSOP		PLASTIC DIP (P)
			(DGK) <sup>§</sup>	SYMBOL	
0°C to 70°C	5 mV	TLV272CD	TLV272CDGK	AVF	—
–40°C to 125°C		TLV272ID	TLV272IDGK	AVG	TLV272IP

<sup>§</sup> This package is available taped and reeled. To order this packaging option, add an R suffix to the part number (e.g., TLV272IDR).

TLV274 AVAILABLE OPTIONS

T <sub>A</sub>	V <sub>IO</sub> MAX AT 25°C	PACKAGED DEVICES		
		SMALL OUTLINE (D) <sup>¶</sup>	PLASTIC DIP (N)	TSSOP (PW) <sup>¶</sup>
0°C to 70°C	5 mV	TLV274CD	—	TLV274CPW
–40°C to 125°C		TLV274ID	TLV274IN	TLV274IPW

<sup>¶</sup> This package is available taped and reeled. To order this packaging option, add an R suffix to the part number (e.g., TLV274IDR).

# TLV271, TLV272, TLV274 FAMILY OF 550- $\mu$ A/Ch 3-MHz RAIL-TO-RAIL OUTPUT OPERATIONAL AMPLIFIERS

SLOS351D – MARCH 2001 – REVISED FEBRUARY 2004

## TLV27x PACKAGE PINOUTS(1)

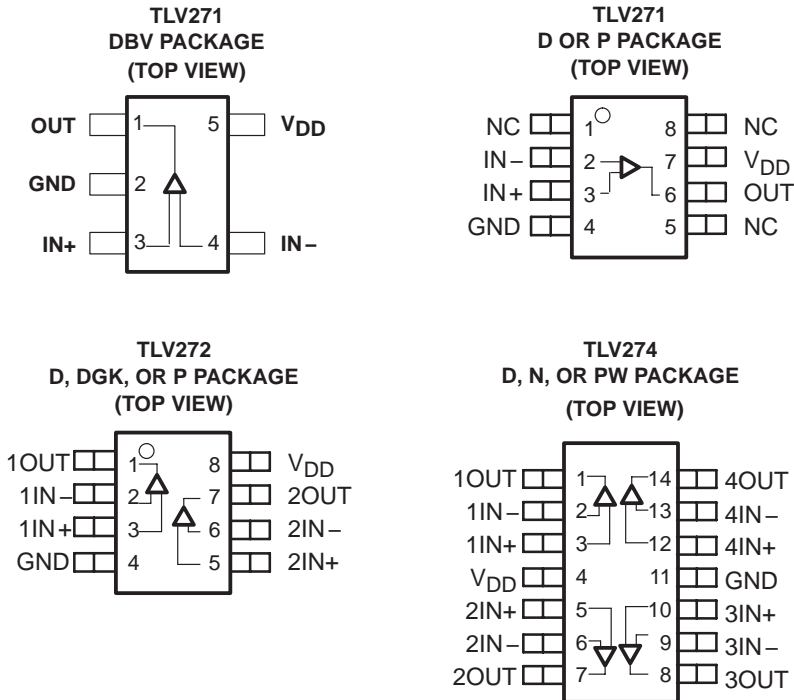

NC – No internal connection  
(1) SOT-23 may or may not be indicated

## TYPICAL PIN 1 INDICATORS

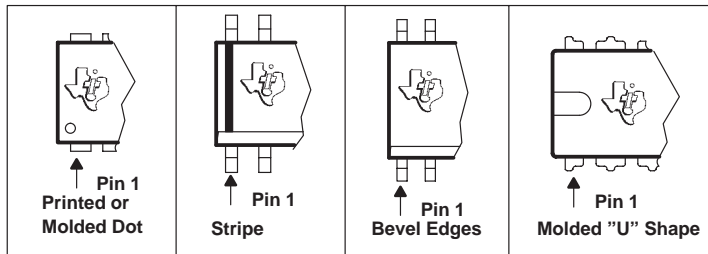

# TLV271, TLV272, TLV274

## FAMILY OF 550- $\mu$ A/Ch 3-MHz RAIL-TO-RAIL OUTPUT OPERATIONAL AMPLIFIERS

SLOS351D – MARCH 2001 – REVISED FEBRUARY 2004

### absolute maximum ratings over operating free-air temperature range (unless otherwise noted)<sup>†</sup>

Supply voltage, $V_{DD}$ (see Note 1)	16.5 V
Differential input voltage, $V_{ID}$	$\pm V_{DD}$
Input voltage range, $V_I$ (see Note 1)	-0.2 V to $V_{DD} + 0.2$ V
Input current range, $I_I$	$\pm 10$ mA
Output current range, $I_O$	$\pm 100$ mA
Continuous total power dissipation	See Dissipation Rating Table
Operating free-air temperature range, $T_A$ : C suffix	0°C to 70°C
I suffix	-40°C to 125°C
Maximum junction temperature, $T_J$	150°C
Storage temperature range, $T_{stg}$	-65°C to 150°C
Lead temperature 1,6 mm (1/16 inch) from case for 10 seconds	260°C

<sup>†</sup> Stresses beyond those listed under “absolute maximum ratings” may cause permanent damage to the device. These are stress ratings only, and functional operation of the device at these or any other conditions beyond those indicated under “recommended operating conditions” is not implied. Exposure to absolute-maximum-rated conditions for extended periods may affect device reliability.

NOTE 1: All voltage values, except differential voltages, are with respect to GND.

DISSIPATION RATING TABLE

PACKAGE	$\theta_{JC}$ (°C/W)	$\theta_{JA}$ (°C/W)	$T_A \leq 25^\circ\text{C}$ POWER RATING	$T_A = 25^\circ\text{C}$ POWER RATING
D (8)	38.3	176	710 mW	396 mW
D (14)	26.9	122.3	1022 mW	531 mW
D (16)	25.7	114.7	1090 mW	567 mW
DBV (5)	55	324.1	385 mW	201 mW
DBV (6)	55	294.3	425 mW	221 mW
DGK (8)	54.23	259.96	481 mW	250 mW
DGS (10)	54.1	257.71	485 mW	252 mW
N (14, 16)	32	78	1600 mW	833 mW
P (8)	41	104	1200 mW	625 mW
PW (14)	29.3	173.6	720 mW	374 mW
PW (16)	28.7	161.4	774 mW	403 mW

### recommended operating conditions

		MIN	MAX	UNIT
Supply voltage, $V_{DD}$	Single supply	2.7	16	V
	Split supply	$\pm 1.35$	$\pm 8$	
Common-mode input voltage range, $V_{ICR}$		0	$V_{DD} - 1.35$	V
Operating free-air temperature, $T_A$	C-suffix	0	70	°C
	I-suffix	-40	125	

**TLV271, TLV272, TLV274**  
**FAMILY OF 550- $\mu$ A/Ch 3-MHz RAIL-TO-RAIL OUTPUT**  
**OPERATIONAL AMPLIFIERS**

SLOS351D – MARCH 2001 – REVISED FEBRUARY 2004

electrical characteristics at specified free-air temperature,  $V_{DD} = 2.7\text{ V}$ ,  $5\text{ V}$ , and  $\pm 5\text{ V}$  (unless otherwise noted)

**dc performance**

PARAMETER		TEST CONDITIONS		$T_A$ †	MIN	TYP	MAX	UNIT
$V_{IO}$	Input offset voltage	$V_{IC} = V_{DD}/2$ , $R_L = 10\text{ k}\Omega$ ,	$V_O = V_{DD}/2$ , $R_S = 50\ \Omega$	25°C	0.5		5	mV
				Full range			7	
$\alpha_{VIO}$	Offset voltage drift			25°C		2		$\mu\text{V}/^\circ\text{C}$
$CMRR$	Common-mode rejection ratio	$V_{IC} = 0\text{ to }V_{DD}-1.35\text{V}$ , $R_S = 50\ \Omega$	$V_{DD} = 2.7\text{ V}$	25°C	58		70	dB
				Full range		55		
		$V_{IC} = 0\text{ to }V_{DD}-1.35\text{V}$ , $R_S = 50\ \Omega$ ,	$V_{DD} = 5\text{ V}$	25°C	65		80	
				Full range		62		
		$V_{IC} = -5\text{ to }V_{DD}-1.35\text{V}$ , $R_S = 50\ \Omega$ ,	$V_{DD} = \pm 5\text{ V}$	25°C	69		85	
				Full range		66		
$A_{VD}$	Large-signal differential voltage amplification	$V_{O(PP)} = V_{DD}/2$ , $R_L = 10\text{ k}\Omega$	$V_{DD} = 2.7\text{ V}$	25°C	97		106	dB
				Full range		76		
			$V_{DD} = 5\text{ V}$	25°C	100		110	
				Full range		86		
			$V_{DD} = \pm 5\text{ V}$	25°C	100		115	
				Full range		90		

† Full range is  $0^\circ\text{C}$  to  $70^\circ\text{C}$  for C suffix and full range is  $-40^\circ\text{C}$  to  $125^\circ\text{C}$  for I suffix. If not specified, full range is  $-40^\circ\text{C}$  to  $125^\circ\text{C}$ .

**input characteristics**

PARAMETER		TEST CONDITIONS		$T_A$	MIN	TYP	MAX	UNIT
$I_{IO}$	Input offset current	$V_{DD} = 5\text{ V}$ , $V_{IC} = V_{DD}/2$ , $V_O = V_{DD}/2$ , $R_S = 50\ \Omega$		25°C		1	60	pA
				70°C			100	
				125°C			1000	
$I_{IB}$	Input bias current			25°C		1	60	pA
				70°C			100	
				125°C			1000	
$r_{i(d)}$	Differential input resistance			25°C		1000		G $\Omega$
$C_{IC}$	Common-mode input capacitance		$f = 21\text{ kHz}$	25°C		8		pF

**TLV271, TLV272, TLV274**  
**FAMILY OF 550- $\mu$ A/Ch 3-MHz RAIL-TO-RAIL OUTPUT**  
**OPERATIONAL AMPLIFIERS**

SLOS351D – MARCH 2001 – REVISED FEBRUARY 2004

electrical characteristics at specified free-air temperature,  $V_{DD} = 2.7\text{ V}$ ,  $5\text{ V}$ , and  $\pm 5\text{ V}$  (unless otherwise noted)

**output characteristics**

PARAMETER	TEST CONDITIONS	$T_A$ †	MIN	TYP	MAX	UNIT
$V_{OH}$ High-level output voltage	$V_{IC} = V_{DD}/2$ , $I_{OH} = -1\text{ mA}$	$V_{DD} = 2.7\text{ V}$	25°C	2.55	2.58	V
			Full range	2.48		
		$V_{DD} = 5\text{ V}$	25°C	4.9	4.93	
			Full range	4.85		
		$V_{DD} = \pm 5\text{ V}$	25°C	4.92	4.96	
			Full range	4.9		
	$V_{IC} = V_{DD}/2$ , $I_{OH} = -5\text{ mA}$	$V_{DD} = 2.7\text{ V}$	25°C	1.9	2.1	
			Full range	1.5		
		$V_{DD} = 5\text{ V}$	25°C	4.6	4.68	
			Full range	4.5		
		$V_{DD} = \pm 5\text{ V}$	25°C	4.7	4.84	
			Full range	4.65		
$V_{OL}$ Low-level output voltage	$V_{IC} = V_{DD}/2$ , $I_{OL} = 1\text{ mA}$	$V_{DD} = 2.7\text{ V}$	25°C	0.1	0.15	V
			Full range		0.22	
		$V_{DD} = 5\text{ V}$	25°C	0.05	0.1	
			Full range		0.15	
		$V_{DD} = \pm 5\text{ V}$	25°C	-4.95	-4.92	
			Full range		-4.9	
	$V_{IC} = V_{DD}/2$ , $I_{OL} = 5\text{ mA}$	$V_{DD} = 2.7\text{ V}$	25°C	0.5	0.7	
			Full range		1.1	
		$V_{DD} = 5\text{ V}$	25°C	0.28	0.4	
			Full range		0.5	
		$V_{DD} = \pm 5\text{ V}$	25°C	-4.84	-4.7	
			Full range		-4.65	
$I_O$ Output current	$V_O = 0.5\text{ V}$ from rail, $V_{DD} = 2.7\text{ V}$	Positive rail	25°C	4	mA	
		Negative rail	25°C	5		
	$V_O = 0.5\text{ V}$ from rail, $V_{DD} = 5\text{ V}$	Positive rail	25°C	7		
		Negative rail	25°C	8		
	$V_O = 0.5\text{ V}$ from rail, $V_{DD} = 10\text{ V}$	Positive rail	25°C	13		
		Negative rail	25°C	12		

† Full range is 0°C to 70°C for C suffix and full range is -40°C to 125°C for I suffix. If not specified, full range is -40°C to 125°C.

‡ Depending on package dissipation rating

**TLV271, TLV272, TLV274**  
**FAMILY OF 550- $\mu$ A/Ch 3-MHz RAIL-TO-RAIL OUTPUT**  
**OPERATIONAL AMPLIFIERS**

SLOS351D – MARCH 2001 – REVISED FEBRUARY 2004

electrical characteristics at specified free-air temperature,  $V_{DD} = 2.7\text{ V}$ ,  $5\text{ V}$ , and  $\pm 5\text{ V}$  (unless otherwise noted) (continued)

**power supply**

PARAMETER		TEST CONDITIONS	$T_A$ †	MIN	TYP	MAX	UNIT
$I_{DD}$	Supply current (per channel)	$V_O = V_{DD}/2$	$V_{DD} = 2.7\text{ V}$	25°C	470	560	$\mu\text{A}$
			$V_{DD} = 5\text{ V}$	25°C	550	660	
			$V_{DD} = 10\text{ V}$	25°C	625	800	
			Full range			1000	
PSRR	Supply voltage rejection ratio ( $\Delta V_{DD} / \Delta V_{IO}$ )	$V_{DD} = 2.7\text{ V to } 16\text{ V}$ , No load	$V_{IC} = V_{DD}/2$	25°C	70	80	dB
				Full range	65		

† Full range is 0°C to 70°C for C suffix and full range is –40°C to 125°C for I suffix. If not specified, full range is –40°C to 125°C.

**dynamic performance**

PARAMETER		TEST CONDITIONS	$T_A$ †	MIN	TYP	MAX	UNIT
UGBW	Unity gain bandwidth	$R_L = 2\text{ k}\Omega$ , $C_L = 10\text{ pF}$	$V_{DD} = 2.7\text{ V}$	25°C	2.4		MHz
			$V_{DD} = 5\text{ V to } 10\text{ V}$	25°C	3		
SR	Slew rate at unity gain	$V_{O(PP)} = V_{DD}/2$ , $C_L = 50\text{ pF}$ , $R_L = 10\text{ k}\Omega$ ,	$V_{DD} = 2.7\text{ V}$	25°C	1.35	2.1	$\text{V}/\mu\text{s}$
				Full range	1		
			$V_{DD} = 5\text{ V}$	25°C	1.45	2.4	$\text{V}/\mu\text{s}$
				Full range	1.2		
			$V_{DD} = \pm 5\text{ V}$	25°C	1.8	2.6	$\text{V}/\mu\text{s}$
				Full range	1.3		
$\phi_m$	Phase margin	$R_L = 2\text{ k}\Omega$	$C_L = 10\text{ pF}$	25°C	65		°
	Gain margin	$R_L = 2\text{ k}\Omega$	$C_L = 10\text{ pF}$	25°C	18		dB
$t_s$	Settling time	$V_{DD} = 2.7\text{ V}$ , $V(\text{STEP})_{PP} = 1\text{ V}$ , $A_V = -1$ , $C_L = 10\text{ pF}$ , $R_L = 2\text{ k}\Omega$	0.1%	25°C	2.9		$\mu\text{s}$
		$V_{DD} = 5\text{ V, } \pm 5\text{ V}$ , $V(\text{STEP})_{PP} = 1\text{ V}$ , $A_V = -1$ , $C_L = 47\text{ pF}$ , $R_L = 2\text{ k}\Omega$	0.1%		2		

† Full range is 0°C to 70°C for C suffix and full range is –40°C to 125°C for I suffix. If not specified, full range is –40°C to 125°C.

**noise/distortion performance**

PARAMETER		TEST CONDITIONS	$T_A$	MIN	TYP	MAX	UNIT
THD + N	Total harmonic distortion plus noise	$V_{DD} = 2.7\text{ V}$ , $V_{O(PP)} = V_{DD}/2\text{ V}$ , $R_L = 2\text{ k}\Omega$ , $f = 10\text{ kHz}$	$A_V = 1$	25°C	0.02%		
			$A_V = 10$		0.05%		
			$A_V = 100$		0.18%		
		$V_{DD} = 5\text{ V, } \pm 5\text{ V}$ , $V_{O(PP)} = V_{DD}/2\text{ V}$ , $R_L = 2\text{ k}\Omega$ , $f = 10\text{ K}$	$A_V = 1$	25°C	0.02%		
			$A_V = 10$		0.09%		
			$A_V = 100$		0.50%		
$V_n$	Equivalent input noise voltage	$f = 1\text{ kHz}$	25°C	39		$\text{nV}/\sqrt{\text{Hz}}$	
		$f = 10\text{ kHz}$		35			
$I_n$	Equivalent input noise current	$f = 1\text{ kHz}$	25°C	0.6		$\text{fA}/\sqrt{\text{Hz}}$	

**TLV271, TLV272, TLV274**  
**FAMILY OF 550- $\mu$ A/Ch 3-MHz RAIL-TO-RAIL OUTPUT**  
**OPERATIONAL AMPLIFIERS**

SLOS351D – MARCH 2001 – REVISED FEBRUARY 2004

**TYPICAL CHARACTERISTICS**

**Table of Graphs**

			<b>FIGURE</b>
CMRR	Common-mode rejection ratio	vs Frequency	1
	Input bias and offset current	vs Free-air temperature	2
V <sub>OL</sub>	Low-level output voltage	vs Low-level output current	3, 5, 7
V <sub>OH</sub>	High-level output voltage	vs High-level output current	4, 6, 8
V <sub>O(PP)</sub>	Peak-to-peak output voltage	vs Frequency	9
I <sub>DD</sub>	Supply current	vs Supply voltage	10
PSRR	Power supply rejection ratio	vs Frequency	11
A <sub>VD</sub>	Differential voltage gain & phase	vs Frequency	12
	Gain-bandwidth product	vs Free-air temperature	13
SR	Slew rate	vs Supply voltage	14
		vs Free-air temperature	15
$\phi_m$	Phase margin	vs Capacitive load	16
V <sub>n</sub>	Equivalent input noise voltage	vs Frequency	17
	Voltage-follower large-signal pulse response		18, 19
	Voltage-follower small-signal pulse response		20
	Inverting large-signal response		21, 22
	Inverting small-signal response		23
	Crosstalk	vs Frequency	24



# TLV271, TLV272, TLV274 FAMILY OF 550- $\mu$ A/Ch 3-MHz RAIL-TO-RAIL OUTPUT OPERATIONAL AMPLIFIERS

SLOS351D – MARCH 2001 – REVISED FEBRUARY 2004

## TYPICAL CHARACTERISTICS

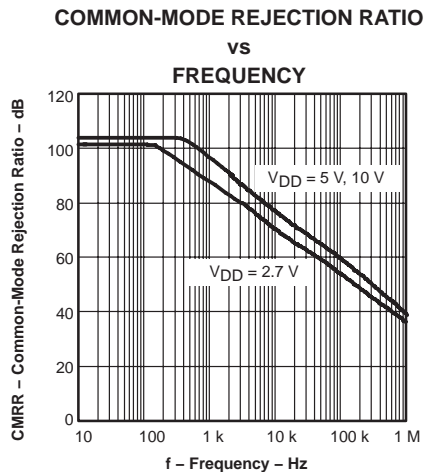

Figure 1

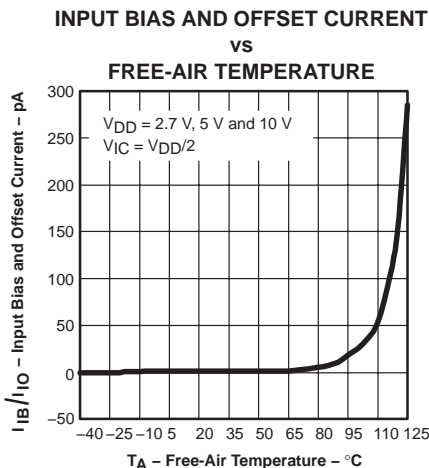

Figure 2

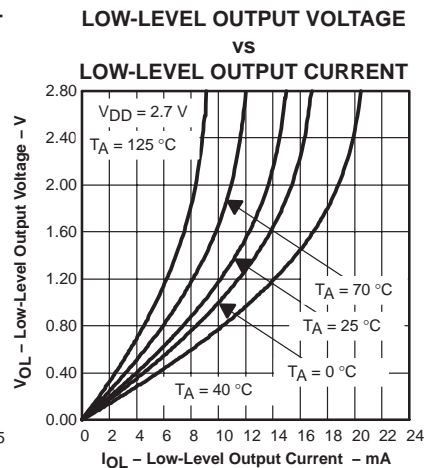

Figure 3

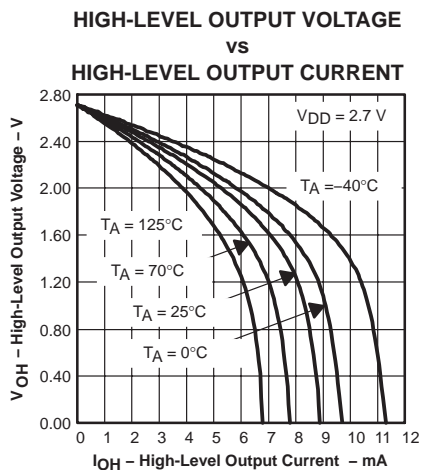

Figure 4

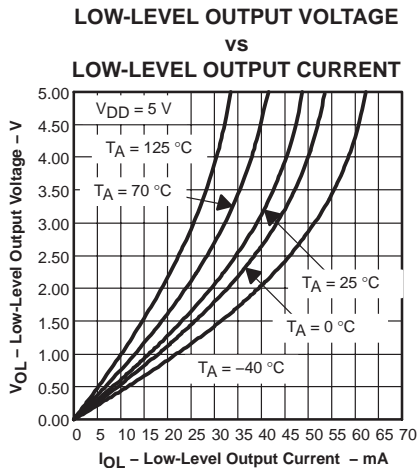

Figure 5

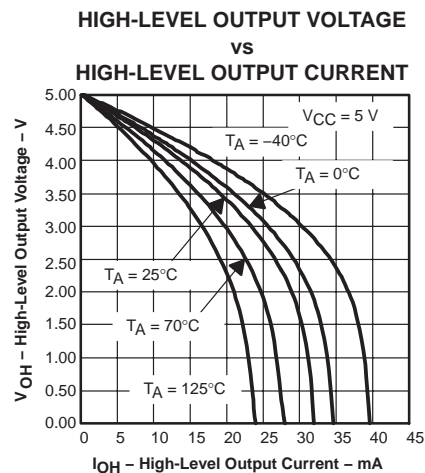

Figure 6

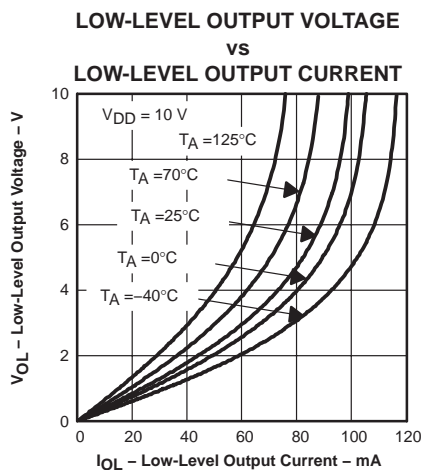

Figure 7

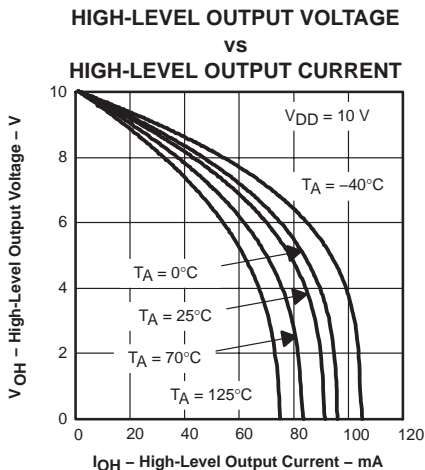

Figure 8

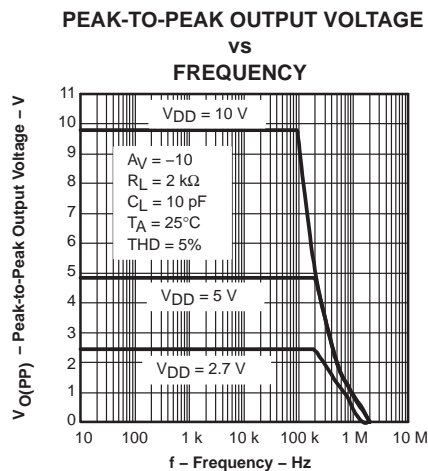

Figure 9

# TLV271, TLV272, TLV274

## FAMILY OF 550- $\mu$ A/Ch 3-MHz RAIL-TO-RAIL OUTPUT OPERATIONAL AMPLIFIERS

SLOS351D – MARCH 2001 – REVISED FEBRUARY 2004

### TYPICAL CHARACTERISTICS

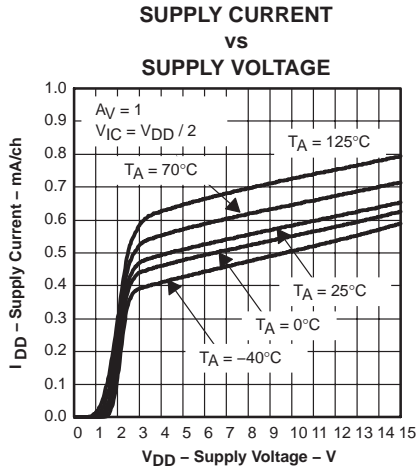

Figure 10

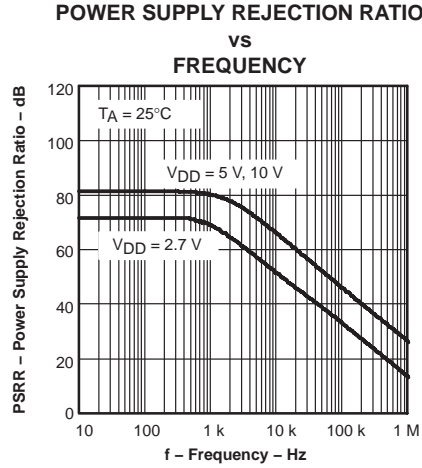

Figure 11

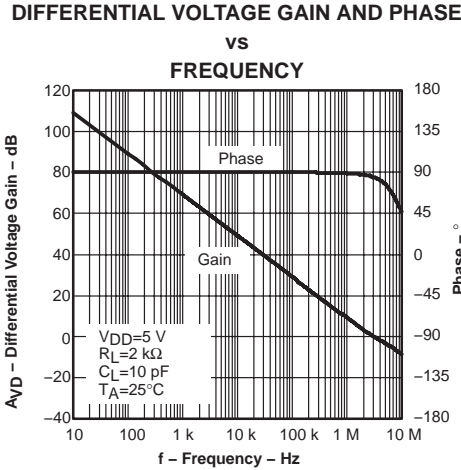

Figure 12

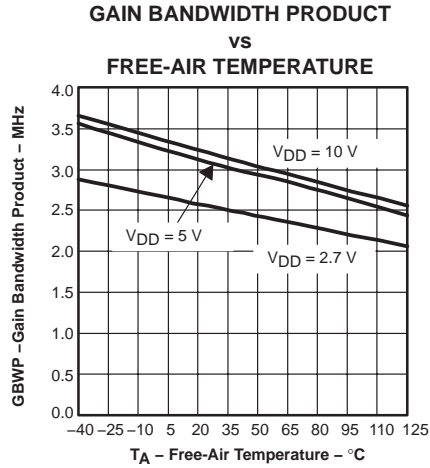

Figure 13

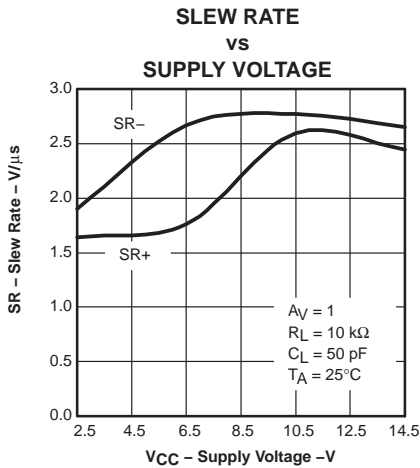

Figure 14

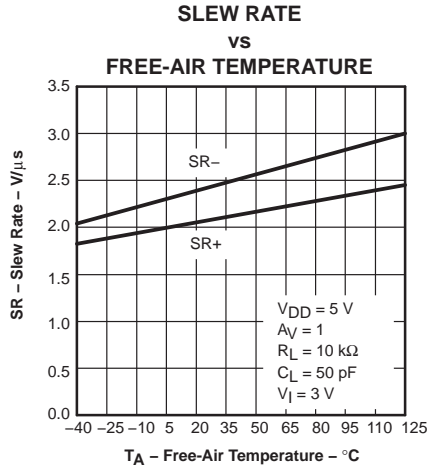

Figure 15

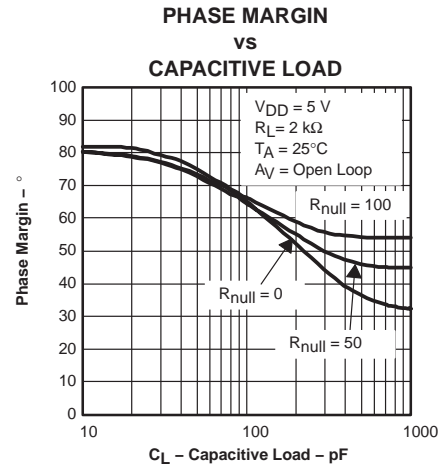

Figure 16

TYPICAL CHARACTERISTICS

EQUIVALENT INPUT NOISE VOLTAGE

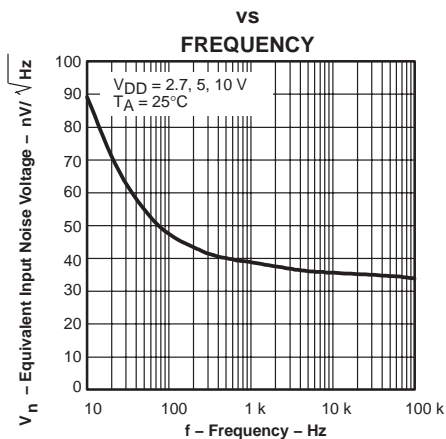

Figure 17

VOLTAGE-FOLLOWER LARGE-SIGNAL PULSE RESPONSE

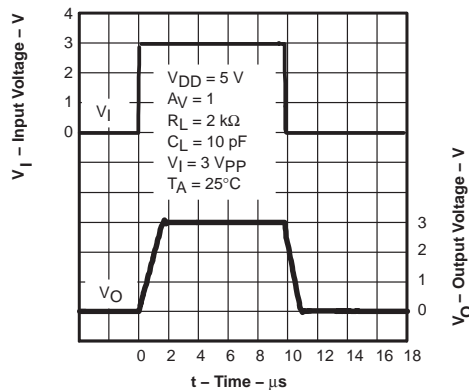

Figure 18

VOLTAGE-FOLLOWER LARGE-SIGNAL PULSE RESPONSE

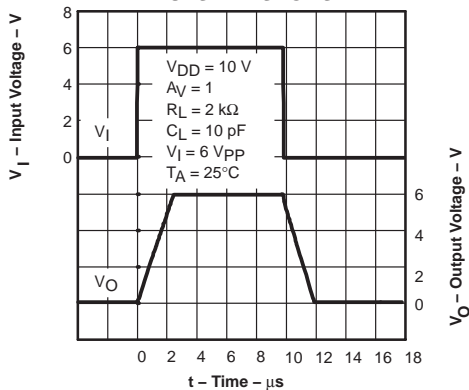

Figure 19

VOLTAGE-FOLLOWER SMALL-SIGNAL PULSE RESPONSE

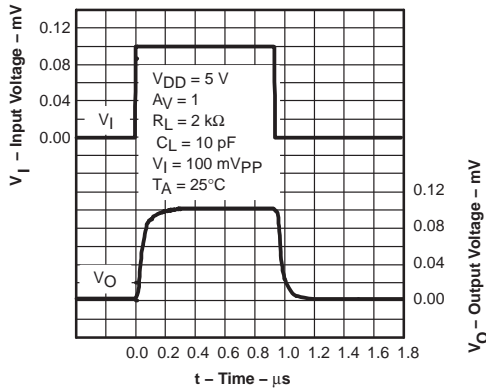

Figure 20

INVERTING LARGE-SIGNAL RESPONSE

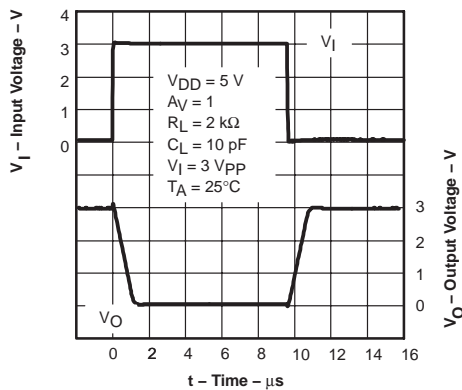

Figure 21

INVERTING LARGE-SIGNAL RESPONSE

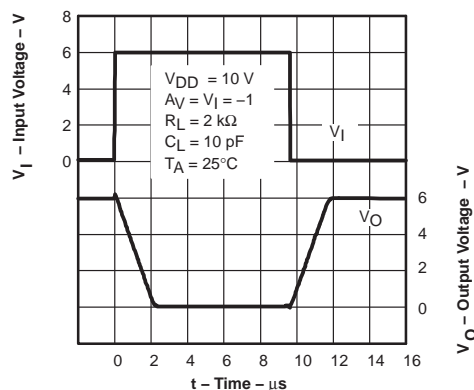

Figure 22

# TLV271, TLV272, TLV274

## FAMILY OF 550- $\mu$ A/Ch 3-MHz RAIL-TO-RAIL OUTPUT OPERATIONAL AMPLIFIERS

SLOS351D – MARCH 2001 – REVISED FEBRUARY 2004

### TYPICAL CHARACTERISTICS

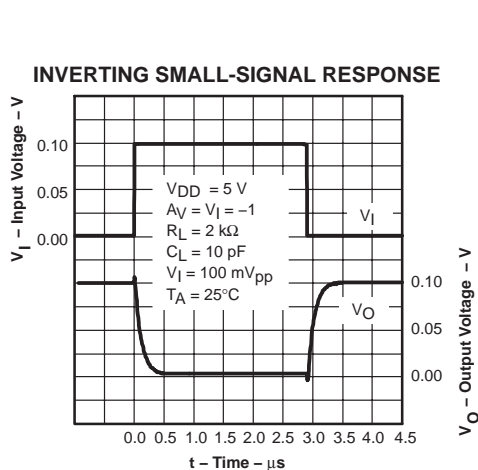

Figure 23

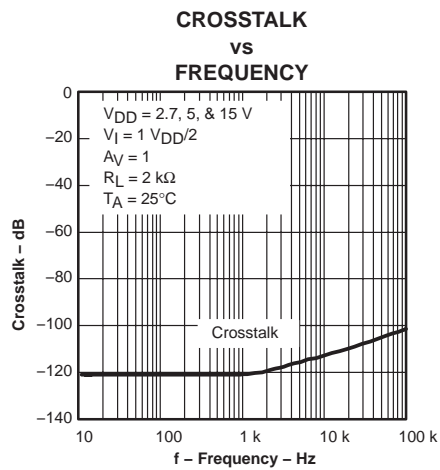

Figure 24

### APPLICATION INFORMATION

#### driving a capacitive load

When the amplifier is configured in this manner, capacitive loading directly on the output decreases the device's phase margin leading to high frequency ringing or oscillations. Therefore, for capacitive loads of greater than 10 pF, it is recommended that a resistor be placed in series ( $R_{NULL}$ ) with the output of the amplifier, as shown in Figure 25. A minimum value of 20  $\Omega$  should work well for most applications.

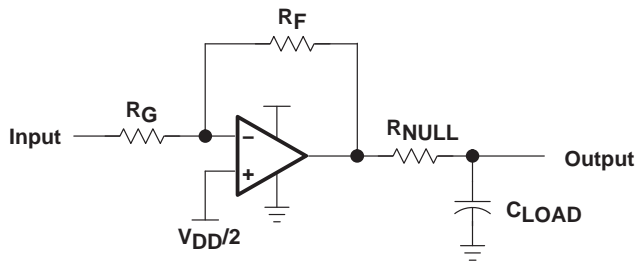

Figure 25. Driving a Capacitive Load

APPLICATION INFORMATION

offset voltage

The output offset voltage, ( $V_{OO}$ ) is the sum of the input offset voltage ( $V_{IO}$ ) and both input bias currents ( $I_{IB}$ ) times the corresponding gains. The following schematic and formula can be used to calculate the output offset voltage:

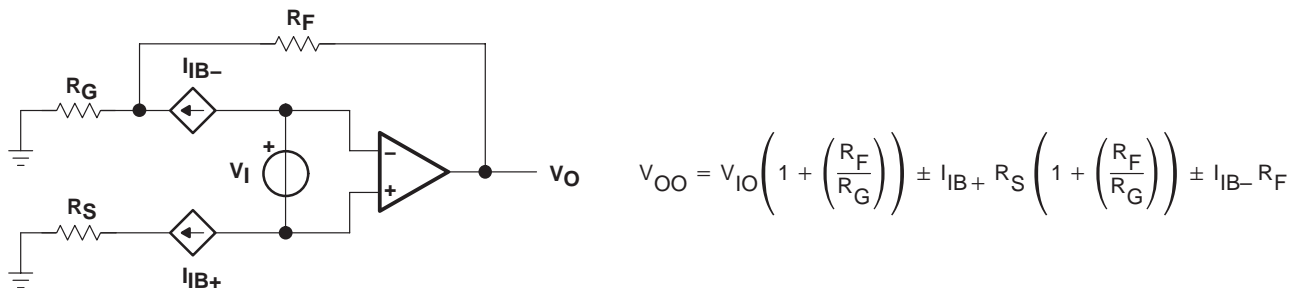

Figure 26. Output Offset Voltage Model

general configurations

When receiving low-level signals, limiting the bandwidth of the incoming signals into the system is often required. The simplest way to accomplish this is to place an RC filter at the noninverting terminal of the amplifier (see Figure 27).

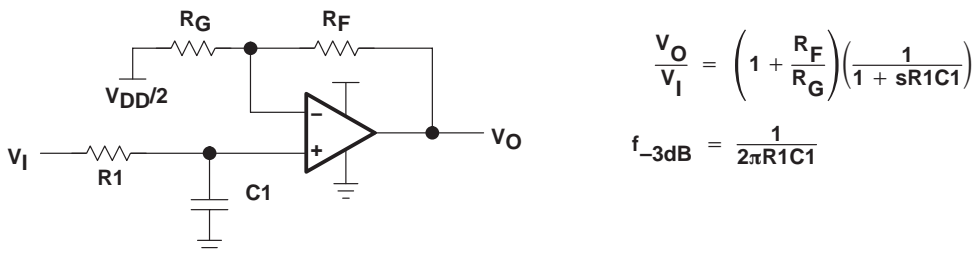

Figure 27. Single-Pole Low-Pass Filter

If even more attenuation is needed, a multiple pole filter is required. The Sallen-Key filter can be used for this task. For best results, the amplifier should have a bandwidth that is 8 to 10 times the filter frequency bandwidth. Failure to do this can result in phase shift of the amplifier.

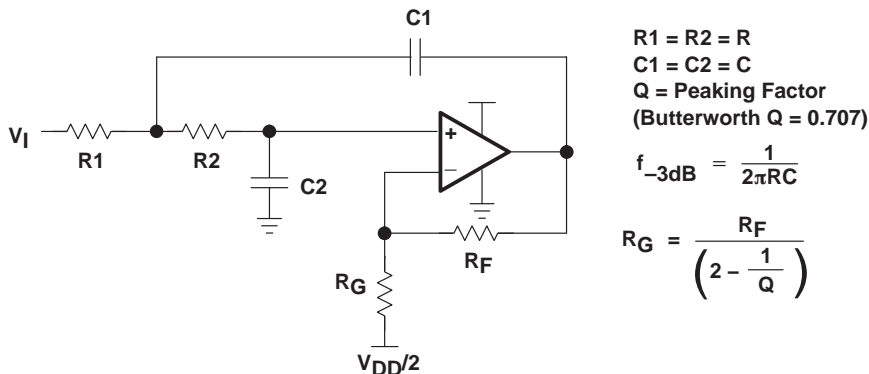

Figure 28. 2-Pole Low-Pass Sallen-Key Filter

# TLV271, TLV272, TLV274

## FAMILY OF 550- $\mu$ A/Ch 3-MHz RAIL-TO-RAIL OUTPUT OPERATIONAL AMPLIFIERS

SLOS351D – MARCH 2001 – REVISED FEBRUARY 2004

---

### APPLICATION INFORMATION

#### circuit layout considerations

To achieve the levels of high performance of the TLV27x, follow proper printed-circuit board design techniques. A general set of guidelines is given in the following.

- Ground planes—It is highly recommended that a ground plane be used on the board to provide all components with a low inductive ground connection. However, in the areas of the amplifier inputs and output, the ground plane can be removed to minimize the stray capacitance.
- Proper power supply decoupling—Use a 6.8- $\mu$ F tantalum capacitor in parallel with a 0.1- $\mu$ F ceramic capacitor on each supply terminal. It may be possible to share the tantalum among several amplifiers depending on the application, but a 0.1- $\mu$ F ceramic capacitor should always be used on the supply terminal of every amplifier. In addition, the 0.1- $\mu$ F capacitor should be placed as close as possible to the supply terminal. As this distance increases, the inductance in the connecting trace makes the capacitor less effective. The designer should strive for distances of less than 0.1 inches between the device power terminals and the ceramic capacitors.
- Sockets—Sockets can be used but are not recommended. The additional lead inductance in the socket pins will often lead to stability problems. Surface-mount packages soldered directly to the printed-circuit board is the best implementation.
- Short trace runs/compact part placements—Optimum high performance is achieved when stray series inductance has been minimized. To realize this, the circuit layout should be made as compact as possible, thereby minimizing the length of all trace runs. Particular attention should be paid to the inverting input of the amplifier. Its length should be kept as short as possible. This helps to minimize stray capacitance at the input of the amplifier.
- Surface-mount passive components—Using surface-mount passive components is recommended for high performance amplifier circuits for several reasons. First, because of the extremely low lead inductance of surface-mount components, the problem with stray series inductance is greatly reduced. Second, the small size of surface-mount components naturally leads to a more compact layout thereby minimizing both stray inductance and capacitance. If leaded components are used, it is recommended that the lead lengths be kept as short as possible.

### APPLICATION INFORMATION

#### general power dissipation considerations

For a given  $\theta_{JA}$ , the maximum power dissipation is shown in Figure 29 and is calculated by the following formula:

$$P_D = \left( \frac{T_{MAX} - T_A}{\theta_{JA}} \right)$$

Where:

- $P_D$  = Maximum power dissipation of TLV27x IC (watts)
- $T_{MAX}$  = Absolute maximum junction temperature (150°C)
- $T_A$  = Free-ambient air temperature (°C)
- $\theta_{JA} = \theta_{JC} + \theta_{CA}$
- $\theta_{JC}$  = Thermal coefficient from junction to case
- $\theta_{CA}$  = Thermal coefficient from case to ambient air (°C/W)

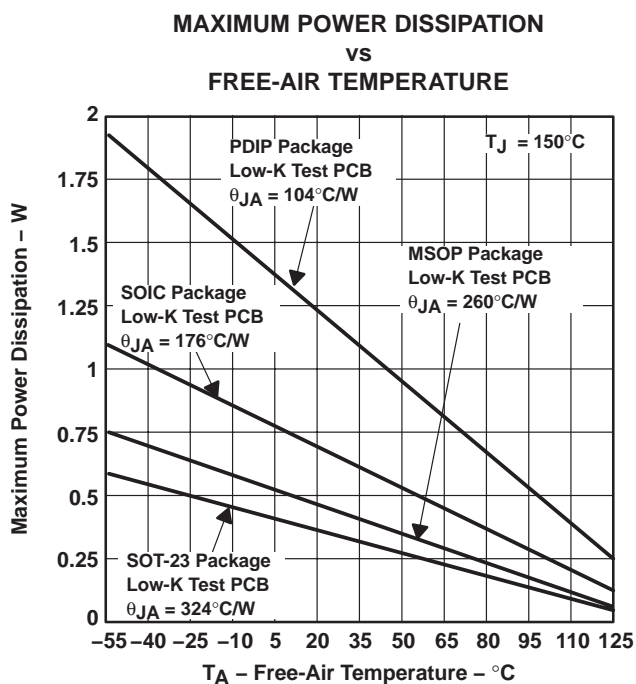

NOTE A: Results are with no air flow and using JEDEC Standard Low-K test PCB.

**Figure 29. Maximum Power Dissipation vs Free-Air Temperature**

# TLV271, TLV272, TLV274 FAMILY OF 550- $\mu$ A/Ch 3-MHz RAIL-TO-RAIL OUTPUT OPERATIONAL AMPLIFIERS

SLOS351D – MARCH 2001 – REVISED FEBRUARY 2004

## APPLICATION INFORMATION

### macromodel information

Macromodel information provided was derived using Microsim *Parts*™ Release 9.1, the model generation software used with Microsim *PSpice*™. The Boyle macromodel (see Note 4) and subcircuit in Figure 30 are generated using TLV27x typical electrical and operating characteristics at  $T_A = 25^\circ\text{C}$ . Using this information, output simulations of the following key parameters can be generated to a tolerance of 20% (in most cases):

- Maximum positive output voltage swing
- Maximum negative output voltage swing
- Slew rate
- Quiescent power dissipation
- Input bias current
- Open-loop voltage amplification
- Unity-gain frequency
- Common-mode rejection ratio
- Phase margin
- DC output resistance
- AC output resistance
- Short-circuit output current limit

NOTE 2: G. R. Boyle, B. M. Cohn, D. O. Pederson, and J. E. Solomon, "Macromodeling of Integrated Circuit Operational Amplifiers," *IEEE Journal of Solid-State Circuits*, SC-9, 353 (1974).

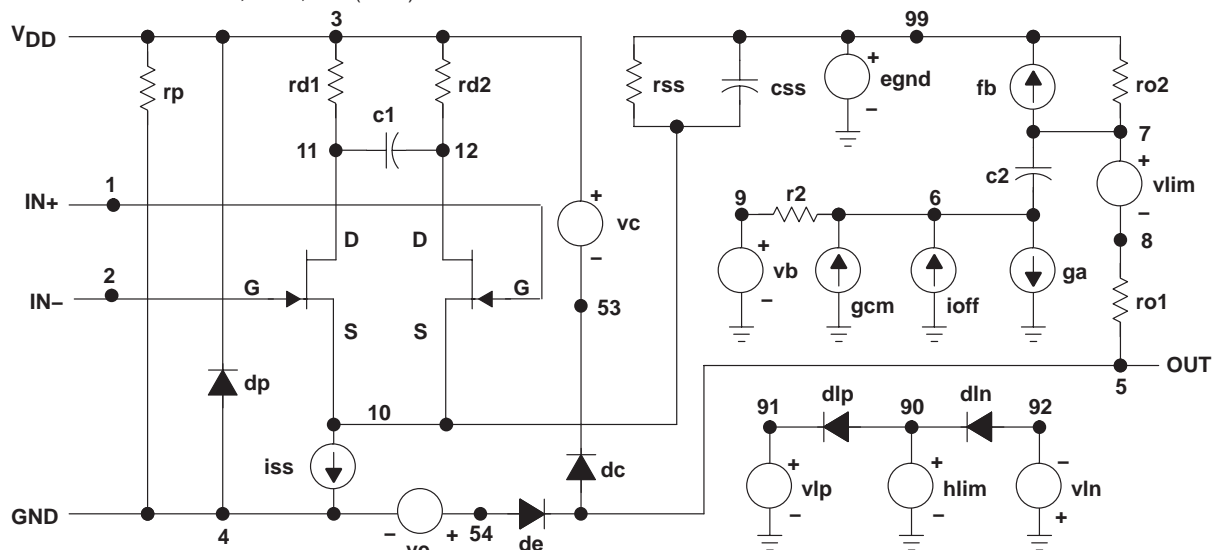

\*DEVICE=amp\_tlv27x\_highVdd,OP AMP,NJF,INT  
 \* amp\_tlv\_27x\_highVdd operational amplifier "macromodel"  
 \* subcircuit updated using Model Editor release 9.1 on 05/15/00  
 \* at 14:40 Model Editor is an OrCAD product.

\* connections:

```

    non-inverting input  |
    inverting input     |
    positive power supply |
    negative power supply|
    output               |
    
```

.subckt amp\_tlv27x\_highVdd

```

    c1 11 12 457.48E-15
    c2 6 7 5.0000E-12
    css 10 99 1.1431E-12
    dc 5 53 dy
    de 54 5 dy
    dlp 90 91 dx
    dln 92 90 dx
    dp 4 3 dx
    egnd 99 0 poly(2) (3,0) (4,0) 0 .5 .5
    fb 7 99 poly(5) vb vc ve vlp vln 0
    
```

```

    ga 6 0 11 12 16.272E-6
    gcm 0 6 10 99 6.8698E-9
    iss 10 4 dc 1.3371E-6
    hlim 90 0 vlim 1K
    j1 11 2 10 jx1
    J2 12 1 10 jx2
    r2 6 9 100.00E3
    rd1 3 11 61.456E3
    rd2 3 12 61.456E3
    ro1 8 5 10
    ro2 7 99 10
    rp 3 4 150.51E3
    rss 10 99 149.58E6
    vb 9 0 dc 0
    vc 3 53 dc .78905
    ve 54 4 dc .78905
    vlim 7 8 dc 0
    vlp 91 0 dc 14.200
    vln 0 92 dc 14.200
    .model dx D(Is=800.00E-18)
    .model dy D(Is=800.00E-18 Rs=1m Cjo=10p)
    .model njf(NJF(Is=500.00E-15 Beta=198.03E-6 Vto=-1)
    .model jx1 NJF(Is=500.00E-15 Beta=198.03E-6 Vto=-1)
    .model jx2 NJF(Is=500.00E-15 Beta=198.03E-6 Vto=-1)
    .ends
    
```

Figure 30. Boyle Macromodel and Subcircuit

PSpice and Parts are trademarks of MicroSim Corporation.



**PACKAGING INFORMATION**

Orderable Device	Status (1)	Package Type	Package Drawing	Pins	Package Qty	Eco Plan (2)	Lead/Ball Finish (6)	MSL Peak Temp (3)	Op Temp (°C)	Device Marking (4/5)	Samples
TLV271CD	ACTIVE	SOIC	D	8	75	Green (RoHS & no Sb/Br)	CU NIPDAU	Level-1-260C-UNLIM	0 to 70	T271C	<a href="#">Samples</a>
TLV271CDBVR	ACTIVE	SOT-23	DBV	5	3000	Green (RoHS & no Sb/Br)	CU NIPDAU	Level-1-260C-UNLIM	0 to 70	VBHC	<a href="#">Samples</a>
TLV271CDBVRG4	ACTIVE	SOT-23	DBV	5	3000	Green (RoHS & no Sb/Br)	CU NIPDAU	Level-1-260C-UNLIM	0 to 70	VBHC	<a href="#">Samples</a>
TLV271CDBVT	ACTIVE	SOT-23	DBV	5	250	Green (RoHS & no Sb/Br)	CU NIPDAU	Level-1-260C-UNLIM	0 to 70	VBHC	<a href="#">Samples</a>
TLV271CDBVTG4	ACTIVE	SOT-23	DBV	5	250	Green (RoHS & no Sb/Br)	CU NIPDAU	Level-1-260C-UNLIM	0 to 70	VBHC	<a href="#">Samples</a>
TLV271CDG4	ACTIVE	SOIC	D	8	75	Green (RoHS & no Sb/Br)	CU NIPDAU	Level-1-260C-UNLIM	0 to 70	T271C	<a href="#">Samples</a>
TLV271CDR	ACTIVE	SOIC	D	8	2500	Green (RoHS & no Sb/Br)	CU NIPDAU	Level-1-260C-UNLIM	0 to 70	T271C	<a href="#">Samples</a>
TLV271CDRG4	ACTIVE	SOIC	D	8	2500	Green (RoHS & no Sb/Br)	CU NIPDAU	Level-1-260C-UNLIM	0 to 70	T271C	<a href="#">Samples</a>
TLV271ID	ACTIVE	SOIC	D	8	75	Green (RoHS & no Sb/Br)	CU NIPDAU	Level-1-260C-UNLIM	-40 to 125	T271I	<a href="#">Samples</a>
TLV271IDBVR	ACTIVE	SOT-23	DBV	5	3000	Green (RoHS & no Sb/Br)	CU NIPDAU	Level-1-260C-UNLIM	-40 to 125	VBHI	<a href="#">Samples</a>
TLV271IDBVRG4	ACTIVE	SOT-23	DBV	5	3000	Green (RoHS & no Sb/Br)	CU NIPDAU	Level-1-260C-UNLIM	-40 to 125	VBHI	<a href="#">Samples</a>
TLV271IDBVT	ACTIVE	SOT-23	DBV	5	250	Green (RoHS & no Sb/Br)	CU NIPDAU	Level-1-260C-UNLIM	-40 to 125	VBHI	<a href="#">Samples</a>
TLV271IDBVTG4	ACTIVE	SOT-23	DBV	5	250	Green (RoHS & no Sb/Br)	CU NIPDAU	Level-1-260C-UNLIM	-40 to 125	VBHI	<a href="#">Samples</a>
TLV271IDG4	ACTIVE	SOIC	D	8	75	Green (RoHS & no Sb/Br)	CU NIPDAU	Level-1-260C-UNLIM	-40 to 125	T271I	<a href="#">Samples</a>
TLV271IDR	ACTIVE	SOIC	D	8	2500	Green (RoHS & no Sb/Br)	CU NIPDAU	Level-1-260C-UNLIM	-40 to 125	T271I	<a href="#">Samples</a>
TLV271IP	ACTIVE	PDIP	P	8	50	Pb-Free (RoHS)	CU NIPDAU	N / A for Pkg Type	-40 to 125	T271I	<a href="#">Samples</a>
TLV271IPE4	ACTIVE	PDIP	P	8	50	Pb-Free (RoHS)	CU NIPDAU	N / A for Pkg Type	-40 to 125	T271I	<a href="#">Samples</a>

Orderable Device	Status (1)	Package Type	Package Drawing	Pins	Package Qty	Eco Plan (2)	Lead/Ball Finish (6)	MSL Peak Temp (3)	Op Temp (°C)	Device Marking (4/5)	Samples
TLV272CD	ACTIVE	SOIC	D	8	75	Green (RoHS & no Sb/Br)	CU NIPDAU	Level-1-260C-UNLIM	0 to 70	T272C	<a href="#">Samples</a>
TLV272CDG4	ACTIVE	SOIC	D	8	75	Green (RoHS & no Sb/Br)	CU NIPDAU	Level-1-260C-UNLIM	0 to 70	T272C	<a href="#">Samples</a>
TLV272CDGK	ACTIVE	VSSOP	DGK	8	80	Green (RoHS & no Sb/Br)	CU NIPDAU   CU NIPDAUAG	Level-1-260C-UNLIM	0 to 70	AVF	<a href="#">Samples</a>
TLV272CDGKG4	ACTIVE	VSSOP	DGK	8	80	Green (RoHS & no Sb/Br)	CU NIPDAU	Level-1-260C-UNLIM	0 to 70	AVF	<a href="#">Samples</a>
TLV272CDGKR	ACTIVE	VSSOP	DGK	8	2500	Green (RoHS & no Sb/Br)	CU NIPDAU   CU NIPDAUAG	Level-1-260C-UNLIM	0 to 70	AVF	<a href="#">Samples</a>
TLV272CDGKRG4	ACTIVE	VSSOP	DGK	8	2500	Green (RoHS & no Sb/Br)	CU NIPDAU	Level-1-260C-UNLIM	0 to 70	AVF	<a href="#">Samples</a>
TLV272CDR	ACTIVE	SOIC	D	8	2500	Green (RoHS & no Sb/Br)	CU NIPDAU	Level-1-260C-UNLIM	0 to 70	T272C	<a href="#">Samples</a>
TLV272CDRG4	ACTIVE	SOIC	D	8	2500	Green (RoHS & no Sb/Br)	CU NIPDAU	Level-1-260C-UNLIM	0 to 70	T272C	<a href="#">Samples</a>
TLV272ID	ACTIVE	SOIC	D	8	75	Green (RoHS & no Sb/Br)	CU NIPDAU	Level-1-260C-UNLIM	-40 to 125	T272I	<a href="#">Samples</a>
TLV272IDG4	ACTIVE	SOIC	D	8	75	Green (RoHS & no Sb/Br)	CU NIPDAU	Level-1-260C-UNLIM	-40 to 125	T272I	<a href="#">Samples</a>
TLV272IDGK	ACTIVE	VSSOP	DGK	8	80	Green (RoHS & no Sb/Br)	CU NIPDAU   CU NIPDAUAG	Level-1-260C-UNLIM	-40 to 125	AVG	<a href="#">Samples</a>
TLV272IDGKG4	ACTIVE	VSSOP	DGK	8	80	Green (RoHS & no Sb/Br)	CU NIPDAU	Level-1-260C-UNLIM	-40 to 125	AVG	<a href="#">Samples</a>
TLV272IDGKR	ACTIVE	VSSOP	DGK	8	2500	Green (RoHS & no Sb/Br)	CU NIPDAU   CU NIPDAUAG	Level-1-260C-UNLIM	-40 to 125	AVG	<a href="#">Samples</a>
TLV272IDGKRG4	ACTIVE	VSSOP	DGK	8	2500	Green (RoHS & no Sb/Br)	CU NIPDAU	Level-1-260C-UNLIM	-40 to 125	AVG	<a href="#">Samples</a>
TLV272IDR	ACTIVE	SOIC	D	8	2500	Green (RoHS & no Sb/Br)	CU NIPDAU	Level-1-260C-UNLIM	-40 to 125	T272I	<a href="#">Samples</a>
TLV272IDRG4	ACTIVE	SOIC	D	8	2500	Green (RoHS & no Sb/Br)	CU NIPDAU	Level-1-260C-UNLIM	-40 to 125	T272I	<a href="#">Samples</a>
TLV272IP	ACTIVE	PDIP	P	8	50	Pb-Free (RoHS)	CU NIPDAU	N / A for Pkg Type	-40 to 125	T272I	<a href="#">Samples</a>
TLV272IPE4	ACTIVE	PDIP	P	8	50	Pb-Free (RoHS)	CU NIPDAU	N / A for Pkg Type	-40 to 125	T272I	<a href="#">Samples</a>

Orderable Device	Status (1)	Package Type	Package Drawing	Pins	Package Qty	Eco Plan (2)	Lead/Ball Finish (6)	MSL Peak Temp (3)	Op Temp (°C)	Device Marking (4/5)	Samples
TLV274CD	ACTIVE	SOIC	D	14	50	Green (RoHS & no Sb/Br)	CU NIPDAU	Level-1-260C-UNLIM	0 to 70	TLV274C	<a href="#">Samples</a>
TLV274CDG4	ACTIVE	SOIC	D	14	50	Green (RoHS & no Sb/Br)	CU NIPDAU	Level-1-260C-UNLIM	0 to 70	TLV274C	<a href="#">Samples</a>
TLV274CDR	ACTIVE	SOIC	D	14	2500	Green (RoHS & no Sb/Br)	CU NIPDAU	Level-1-260C-UNLIM	0 to 70	TLV274C	<a href="#">Samples</a>
TLV274CDRG4	ACTIVE	SOIC	D	14	2500	Green (RoHS & no Sb/Br)	CU NIPDAU	Level-1-260C-UNLIM	0 to 70	TLV274C	<a href="#">Samples</a>
TLV274CPW	ACTIVE	TSSOP	PW	14	90	Green (RoHS & no Sb/Br)	CU NIPDAU	Level-1-260C-UNLIM	0 to 70	TLV274C	<a href="#">Samples</a>
TLV274CPWG4	ACTIVE	TSSOP	PW	14	90	Green (RoHS & no Sb/Br)	CU NIPDAU	Level-1-260C-UNLIM	0 to 70	TLV274C	<a href="#">Samples</a>
TLV274CPWR	ACTIVE	TSSOP	PW	14	2000	Green (RoHS & no Sb/Br)	CU NIPDAU	Level-1-260C-UNLIM	0 to 70	TLV274C	<a href="#">Samples</a>
TLV274CPWRG4	ACTIVE	TSSOP	PW	14	2000	Green (RoHS & no Sb/Br)	CU NIPDAU	Level-1-260C-UNLIM	0 to 70	TLV274C	<a href="#">Samples</a>
TLV274ID	ACTIVE	SOIC	D	14	50	Green (RoHS & no Sb/Br)	CU NIPDAU	Level-1-260C-UNLIM	-40 to 125	TLV274I	<a href="#">Samples</a>
TLV274IDG4	ACTIVE	SOIC	D	14	50	Green (RoHS & no Sb/Br)	CU NIPDAU	Level-1-260C-UNLIM	-40 to 125	TLV274I	<a href="#">Samples</a>
TLV274IDR	ACTIVE	SOIC	D	14	2500	Green (RoHS & no Sb/Br)	CU NIPDAU	Level-1-260C-UNLIM	-40 to 125	TLV274I	<a href="#">Samples</a>
TLV274IDRG4	ACTIVE	SOIC	D	14	2500	Green (RoHS & no Sb/Br)	CU NIPDAU	Level-1-260C-UNLIM	-40 to 125	TLV274I	<a href="#">Samples</a>
TLV274IN	ACTIVE	PDIP	N	14	25	Pb-Free (RoHS)	CU NIPDAU	N / A for Pkg Type	-40 to 125	TLV274I	<a href="#">Samples</a>
TLV274INE4	ACTIVE	PDIP	N	14	25	Pb-Free (RoHS)	CU NIPDAU	N / A for Pkg Type	-40 to 125	TLV274I	<a href="#">Samples</a>
TLV274IPW	ACTIVE	TSSOP	PW	14	90	Green (RoHS & no Sb/Br)	CU NIPDAU	Level-1-260C-UNLIM	-40 to 125	TLV274I	<a href="#">Samples</a>
TLV274IPWG4	ACTIVE	TSSOP	PW	14	90	Green (RoHS & no Sb/Br)	CU NIPDAU	Level-1-260C-UNLIM	-40 to 125	TLV274I	<a href="#">Samples</a>
TLV274IPWR	ACTIVE	TSSOP	PW	14	2000	Green (RoHS & no Sb/Br)	CU NIPDAU	Level-1-260C-UNLIM	-40 to 125	TLV274I	<a href="#">Samples</a>
TLV274IPWRG4	ACTIVE	TSSOP	PW	14	2000	Green (RoHS & no Sb/Br)	CU NIPDAU	Level-1-260C-UNLIM	-40 to 125	TLV274I	<a href="#">Samples</a>

(1) The marketing status values are defined as follows:

**ACTIVE:** Product device recommended for new designs.

**LIFEBUY:** TI has announced that the device will be discontinued, and a lifetime-buy period is in effect.

**NRND:** Not recommended for new designs. Device is in production to support existing customers, but TI does not recommend using this part in a new design.

**PREVIEW:** Device has been announced but is not in production. Samples may or may not be available.

**OBSOLETE:** TI has discontinued the production of the device.

(2) Eco Plan - The planned eco-friendly classification: Pb-Free (RoHS), Pb-Free (RoHS Exempt), or Green (RoHS & no Sb/Br) - please check <http://www.ti.com/productcontent> for the latest availability information and additional product content details.

**TBD:** The Pb-Free/Green conversion plan has not been defined.

**Pb-Free (RoHS):** TI's terms "Lead-Free" or "Pb-Free" mean semiconductor products that are compatible with the current RoHS requirements for all 6 substances, including the requirement that lead not exceed 0.1% by weight in homogeneous materials. Where designed to be soldered at high temperatures, TI Pb-Free products are suitable for use in specified lead-free processes.

**Pb-Free (RoHS Exempt):** This component has a RoHS exemption for either 1) lead-based flip-chip solder bumps used between the die and package, or 2) lead-based die adhesive used between the die and leadframe. The component is otherwise considered Pb-Free (RoHS compatible) as defined above.

**Green (RoHS & no Sb/Br):** TI defines "Green" to mean Pb-Free (RoHS compatible), and free of Bromine (Br) and Antimony (Sb) based flame retardants (Br or Sb do not exceed 0.1% by weight in homogeneous material)

(3) MSL, Peak Temp. - The Moisture Sensitivity Level rating according to the JEDEC industry standard classifications, and peak solder temperature.

(4) There may be additional marking, which relates to the logo, the lot trace code information, or the environmental category on the device.

(5) Multiple Device Markings will be inside parentheses. Only one Device Marking contained in parentheses and separated by a "~" will appear on a device. If a line is indented then it is a continuation of the previous line and the two combined represent the entire Device Marking for that device.

(6) Lead/Ball Finish - Orderable Devices may have multiple material finish options. Finish options are separated by a vertical ruled line. Lead/Ball Finish values may wrap to two lines if the finish value exceeds the maximum column width.

**Important Information and Disclaimer:** The information provided on this page represents TI's knowledge and belief as of the date that it is provided. TI bases its knowledge and belief on information provided by third parties, and makes no representation or warranty as to the accuracy of such information. Efforts are underway to better integrate information from third parties. TI has taken and continues to take reasonable steps to provide representative and accurate information but may not have conducted destructive testing or chemical analysis on incoming materials and chemicals. TI and TI suppliers consider certain information to be proprietary, and thus CAS numbers and other limited information may not be available for release.

In no event shall TI's liability arising out of such information exceed the total purchase price of the TI part(s) at issue in this document sold by TI to Customer on an annual basis.

**OTHER QUALIFIED VERSIONS OF TLV271, TLV272, TLV274 :**

- Automotive: [TLV271-Q1](#), [TLV272-Q1](#), [TLV274-Q1](#)

NOTE: Qualified Version Definitions:

- Automotive - Q100 devices qualified for high-reliability automotive applications targeting zero defects

## TAPE AND REEL INFORMATION

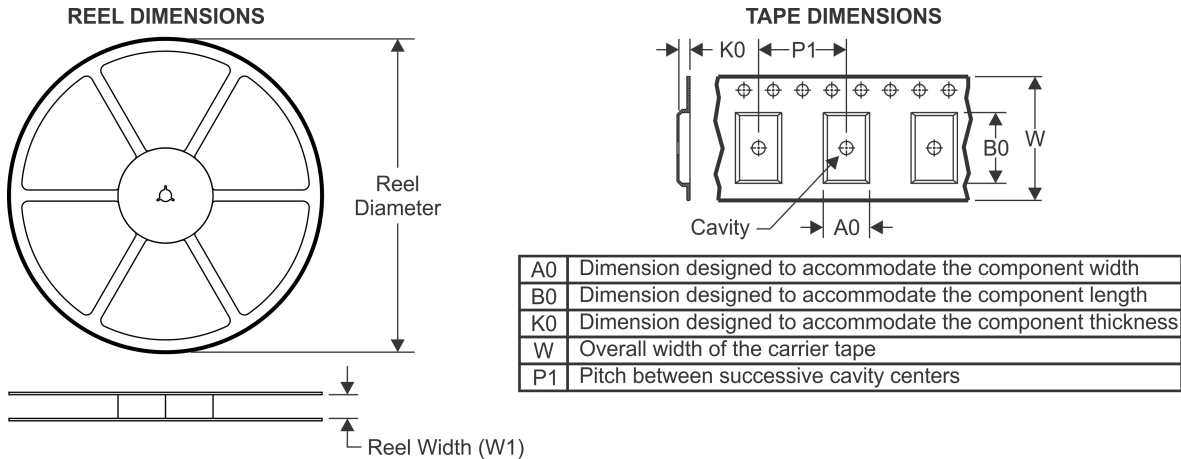

### QUADRANT ASSIGNMENTS FOR PIN 1 ORIENTATION IN TAPE



\*All dimensions are nominal

Device	Package Type	Package Drawing	Pins	SPQ	Reel Diameter (mm)	Reel Width W1 (mm)	A0 (mm)	B0 (mm)	K0 (mm)	P1 (mm)	W (mm)	Pin1 Quadrant
TLV271CDBVR	SOT-23	DBV	5	3000	178.0	9.0	3.23	3.17	1.37	4.0	8.0	Q3
TLV271CDBVT	SOT-23	DBV	5	250	178.0	9.0	3.3	3.2	1.4	4.0	8.0	Q3
TLV271CDR	SOIC	D	8	2500	330.0	12.4	6.4	5.2	2.1	8.0	12.0	Q1
TLV271IDBVR	SOT-23	DBV	5	3000	178.0	9.0	3.3	3.2	1.4	4.0	8.0	Q3
TLV271IDBVT	SOT-23	DBV	5	250	178.0	9.0	3.3	3.2	1.4	4.0	8.0	Q3
TLV271IDR	SOIC	D	8	2500	330.0	12.4	6.4	5.2	2.1	8.0	12.0	Q1
TLV272CDGKR	VSSOP	DGK	8	2500	330.0	12.4	5.3	3.4	1.4	8.0	12.0	Q1
TLV272CDGKR	VSSOP	DGK	8	2500	330.0	12.4	5.3	3.4	1.4	8.0	12.0	Q1
TLV272CDR	SOIC	D	8	2500	330.0	12.4	6.4	5.2	2.1	8.0	12.0	Q1
TLV272IDGKR	VSSOP	DGK	8	2500	330.0	12.4	5.3	3.4	1.4	8.0	12.0	Q1
TLV272IDGKR	VSSOP	DGK	8	2500	330.0	12.4	5.3	3.4	1.4	8.0	12.0	Q1
TLV272IDR	SOIC	D	8	2500	330.0	12.4	6.4	5.2	2.1	8.0	12.0	Q1
TLV274CDR	SOIC	D	14	2500	330.0	16.4	6.5	9.0	2.1	8.0	16.0	Q1
TLV274CPWR	TSSOP	PW	14	2000	330.0	12.4	6.9	5.6	1.6	8.0	12.0	Q1
TLV274IDR	SOIC	D	14	2500	330.0	16.4	6.5	9.0	2.1	8.0	16.0	Q1
TLV274IPWR	TSSOP	PW	14	2000	330.0	12.4	6.9	5.6	1.6	8.0	12.0	Q1

**TAPE AND REEL BOX DIMENSIONS**

\*All dimensions are nominal

Device	Package Type	Package Drawing	Pins	SPQ	Length (mm)	Width (mm)	Height (mm)
TLV271CDBVR	SOT-23	DBV	5	3000	180.0	180.0	18.0
TLV271CDBVT	SOT-23	DBV	5	250	180.0	180.0	18.0
TLV271CDR	SOIC	D	8	2500	340.5	338.1	20.6
TLV271IDBVR	SOT-23	DBV	5	3000	180.0	180.0	18.0
TLV271IDBVT	SOT-23	DBV	5	250	180.0	180.0	18.0
TLV271IDR	SOIC	D	8	2500	340.5	338.1	20.6
TLV272CDGKR	VSSOP	DGK	8	2500	358.0	335.0	35.0
TLV272CDGKR	VSSOP	DGK	8	2500	364.0	364.0	27.0
TLV272CDR	SOIC	D	8	2500	340.5	338.1	20.6
TLV272IDGKR	VSSOP	DGK	8	2500	358.0	335.0	35.0
TLV272IDGKR	VSSOP	DGK	8	2500	364.0	364.0	27.0
TLV272IDR	SOIC	D	8	2500	340.5	338.1	20.6
TLV274CDR	SOIC	D	14	2500	333.2	345.9	28.6
TLV274CPWR	TSSOP	PW	14	2000	367.0	367.0	35.0
TLV274IDR	SOIC	D	14	2500	333.2	345.9	28.6
TLV274IPWR	TSSOP	PW	14	2000	367.0	367.0	35.0

## IMPORTANT NOTICE

Texas Instruments Incorporated and its subsidiaries (TI) reserve the right to make corrections, enhancements, improvements and other changes to its semiconductor products and services per JESD46, latest issue, and to discontinue any product or service per JESD48, latest issue. Buyers should obtain the latest relevant information before placing orders and should verify that such information is current and complete. All semiconductor products (also referred to herein as "components") are sold subject to TI's terms and conditions of sale supplied at the time of order acknowledgment.

TI warrants performance of its components to the specifications applicable at the time of sale, in accordance with the warranty in TI's terms and conditions of sale of semiconductor products. Testing and other quality control techniques are used to the extent TI deems necessary to support this warranty. Except where mandated by applicable law, testing of all parameters of each component is not necessarily performed.

TI assumes no liability for applications assistance or the design of Buyers' products. Buyers are responsible for their products and applications using TI components. To minimize the risks associated with Buyers' products and applications, Buyers should provide adequate design and operating safeguards.

TI does not warrant or represent that any license, either express or implied, is granted under any patent right, copyright, mask work right, or other intellectual property right relating to any combination, machine, or process in which TI components or services are used. Information published by TI regarding third-party products or services does not constitute a license to use such products or services or a warranty or endorsement thereof. Use of such information may require a license from a third party under the patents or other intellectual property of the third party, or a license from TI under the patents or other intellectual property of TI.

Reproduction of significant portions of TI information in TI data books or data sheets is permissible only if reproduction is without alteration and is accompanied by all associated warranties, conditions, limitations, and notices. TI is not responsible or liable for such altered documentation. Information of third parties may be subject to additional restrictions.

Resale of TI components or services with statements different from or beyond the parameters stated by TI for that component or service voids all express and any implied warranties for the associated TI component or service and is an unfair and deceptive business practice. TI is not responsible or liable for any such statements.

Buyer acknowledges and agrees that it is solely responsible for compliance with all legal, regulatory and safety-related requirements concerning its products, and any use of TI components in its applications, notwithstanding any applications-related information or support that may be provided by TI. Buyer represents and agrees that it has all the necessary expertise to create and implement safeguards which anticipate dangerous consequences of failures, monitor failures and their consequences, lessen the likelihood of failures that might cause harm and take appropriate remedial actions. Buyer will fully indemnify TI and its representatives against any damages arising out of the use of any TI components in safety-critical applications.

In some cases, TI components may be promoted specifically to facilitate safety-related applications. With such components, TI's goal is to help enable customers to design and create their own end-product solutions that meet applicable functional safety standards and requirements. Nonetheless, such components are subject to these terms.

No TI components are authorized for use in FDA Class III (or similar life-critical medical equipment) unless authorized officers of the parties have executed a special agreement specifically governing such use.

Only those TI components which TI has specifically designated as military grade or "enhanced plastic" are designed and intended for use in military/aerospace applications or environments. Buyer acknowledges and agrees that any military or aerospace use of TI components which have **not** been so designated is solely at the Buyer's risk, and that Buyer is solely responsible for compliance with all legal and regulatory requirements in connection with such use.

TI has specifically designated certain components as meeting ISO/TS16949 requirements, mainly for automotive use. In any case of use of non-designated products, TI will not be responsible for any failure to meet ISO/TS16949.

### Products

Audio	<a href="http://www.ti.com/audio">www.ti.com/audio</a>
Amplifiers	<a href="http://amplifier.ti.com">amplifier.ti.com</a>
Data Converters	<a href="http://dataconverter.ti.com">dataconverter.ti.com</a>
DLP® Products	<a href="http://www.dlp.com">www.dlp.com</a>
DSP	<a href="http://dsp.ti.com">dsp.ti.com</a>
Clocks and Timers	<a href="http://www.ti.com/clocks">www.ti.com/clocks</a>
Interface	<a href="http://interface.ti.com">interface.ti.com</a>
Logic	<a href="http://logic.ti.com">logic.ti.com</a>
Power Mgmt	<a href="http://power.ti.com">power.ti.com</a>
Microcontrollers	<a href="http://microcontroller.ti.com">microcontroller.ti.com</a>
RFID	<a href="http://www.ti-rfid.com">www.ti-rfid.com</a>
OMAP Applications Processors	<a href="http://www.ti.com/omap">www.ti.com/omap</a>
Wireless Connectivity	<a href="http://www.ti.com/wirelessconnectivity">www.ti.com/wirelessconnectivity</a>

### Applications

Automotive and Transportation	<a href="http://www.ti.com/automotive">www.ti.com/automotive</a>
Communications and Telecom	<a href="http://www.ti.com/communications">www.ti.com/communications</a>
Computers and Peripherals	<a href="http://www.ti.com/computers">www.ti.com/computers</a>
Consumer Electronics	<a href="http://www.ti.com/consumer-apps">www.ti.com/consumer-apps</a>
Energy and Lighting	<a href="http://www.ti.com/energy">www.ti.com/energy</a>
Industrial	<a href="http://www.ti.com/industrial">www.ti.com/industrial</a>
Medical	<a href="http://www.ti.com/medical">www.ti.com/medical</a>
Security	<a href="http://www.ti.com/security">www.ti.com/security</a>
Space, Avionics and Defense	<a href="http://www.ti.com/space-avionics-defense">www.ti.com/space-avionics-defense</a>
Video and Imaging	<a href="http://www.ti.com/video">www.ti.com/video</a>

### TI E2E Community

[e2e.ti.com](http://e2e.ti.com)