

### NAP-06-472

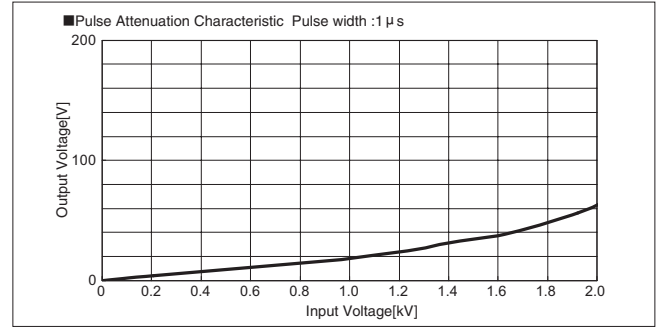

### NAP-10-472

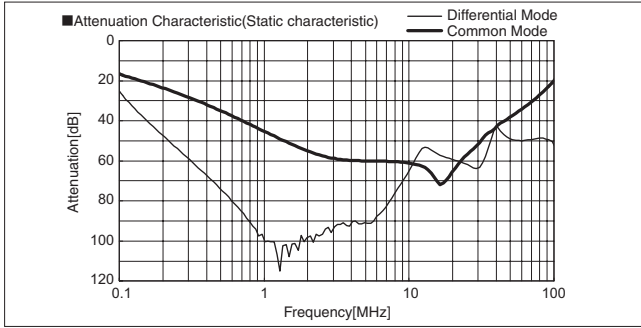
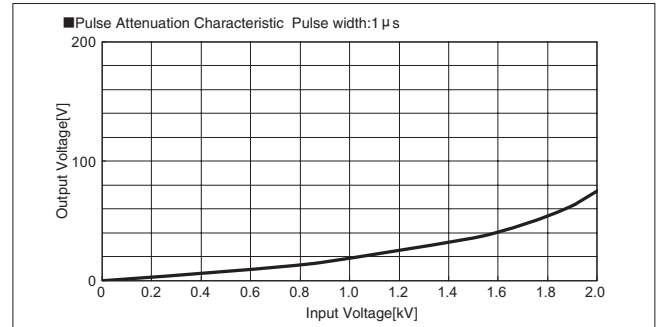
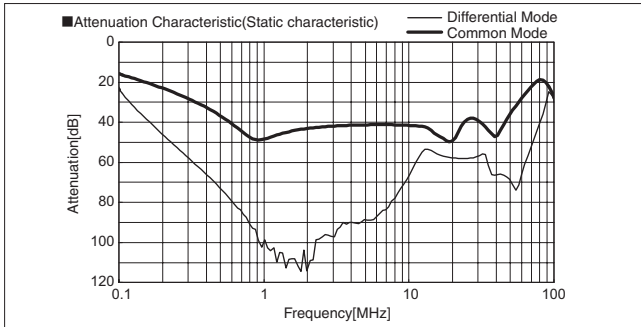

### NAP-16-472

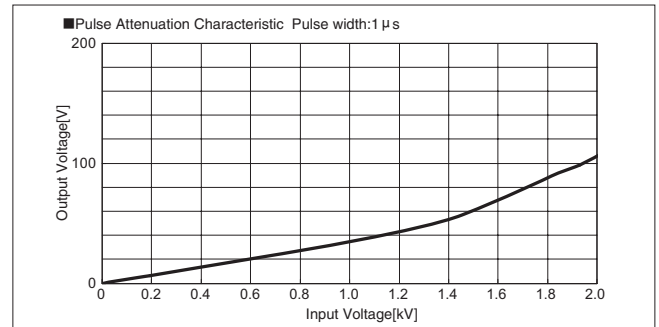
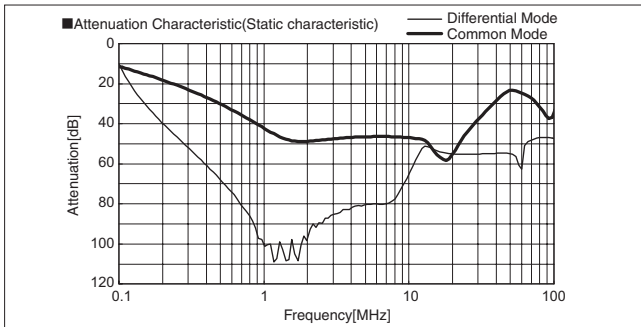

### NAP-20-472

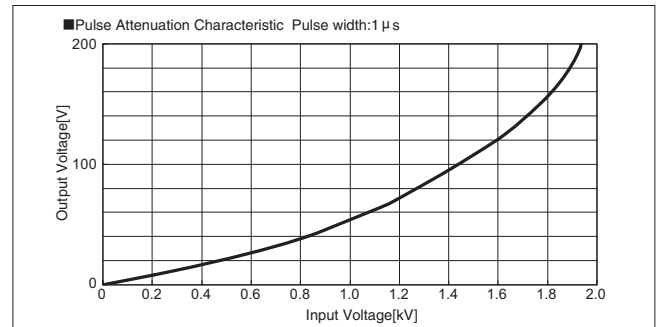
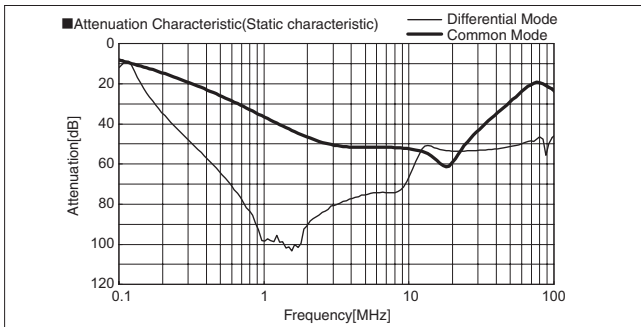

### NAP-30-472

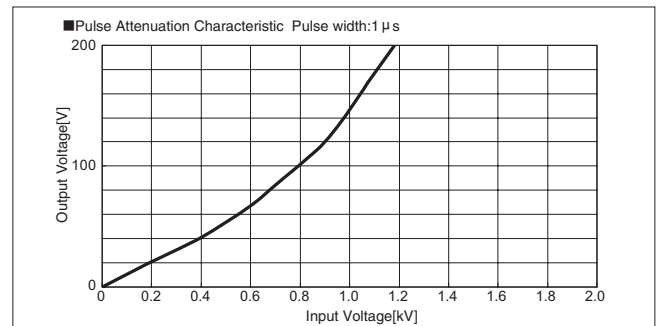
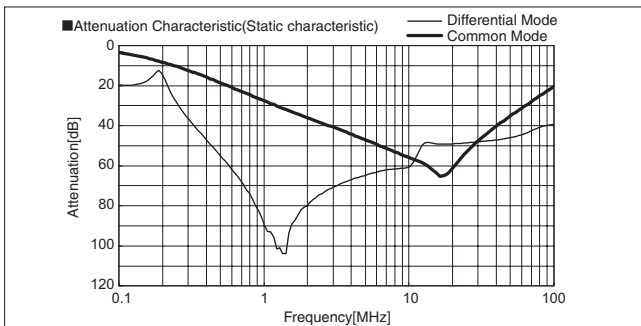

## 1 Method of connecting EMI/EMC Filter

### (1) Single Phase

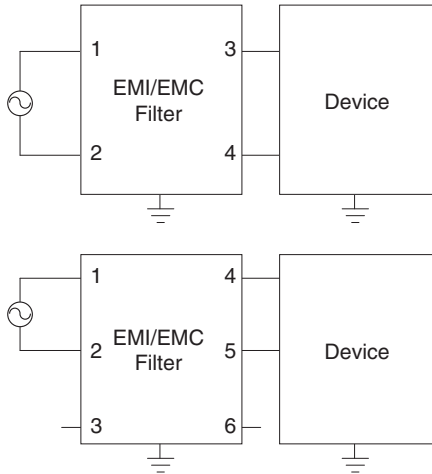

※Three phase EMI/EMC filter is also available as a single phase input type.

### (2) Three phase (Delta-connection)

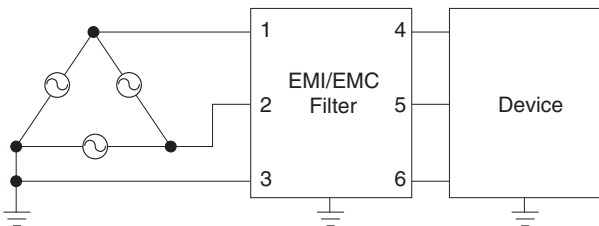

### (3) Three phase (Star-connection)

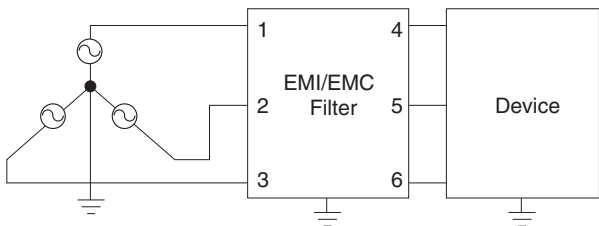

[Reference] Example of calculating input current calculation

Input voltage 400 [V]

Input capacity of the equipment 4000 [VA]

$$\text{Input current} = \frac{4000 \text{ [VA]}}{400 \text{ [V]} \times \sqrt{3}} = 5.8 \text{ [A]}$$

## 2 Caution when connecting EMI/EMC Filter

Please note the excessive temperature increase of EMI/EMC filter. Please contact us if judgement is difficult.

### (1) Input voltage and frequency

Please use within the rated voltage (or maximum voltage) of each model.

Input frequency specification for AC input EMI/EMC filter is considered as commercial frequency (50/60Hz).

It should not be used under the following conditions.

- 1) Distorted input voltage waveform.  
(Triangle wave, square wave etc.)
- 2) High input frequency (ex: 400Hz)

### (2) Input current

Please use within the rated current of each model.

EMI/EMC filters have short term peak current capability. Therefore, it can flow ~40A or ten times of rated current, non-repeated, within a few ms such as inrush current of power supply etc.

However, it should not be used under the following conditions.

- 1) Long duration peak current.
- 2) Peak current or high-frequency current is continuously flowing.

### (3) Connection to a general-purpose inverter (servo driver)

Please connect EMI/EMC filter to input side of inverter driver (servo driver).

It should not be used between the inverter (servo driver) and the motor.

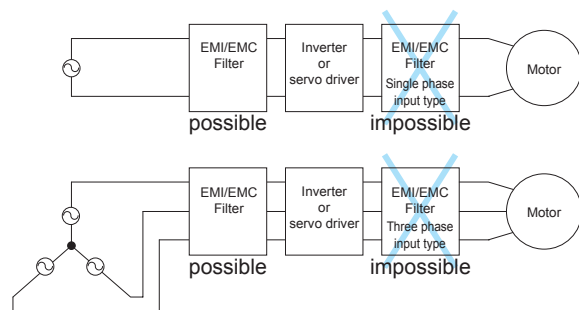

## 3 Safety Considerations

- To apply for safety standard approval using this EMI/EMC Filter, the following conditions must be met.
- The unit must be used as a component of an end-use equipment.
- Protection earth terminal (PE) must be connected to safety ground of end-use equipment.

### (1) Attenuation Characteristic(Static characteristic)

※ Attenuation=  $20\log(U_{b1}/U_{b2})$ (dB)  
 $U_{b1}$ : Voltage in state without filters  
 $U_{b2}$ : Voltage in state which added filters  
 ※ N.A.: Network analyzer

■ Object product : Single phase input type (Differential mode)



■ Object product : Single phase input type (Common mode)

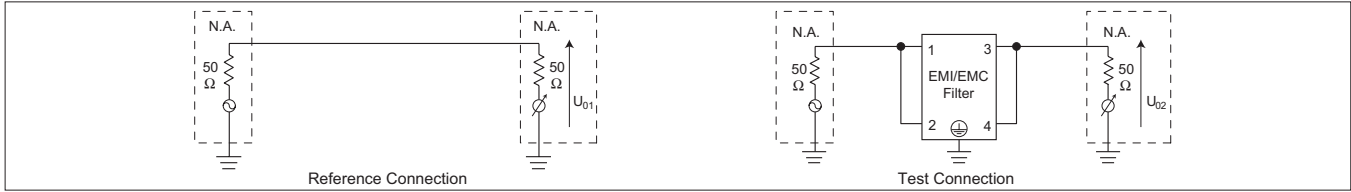

■ Object product : Three phase input type (Differential mode)

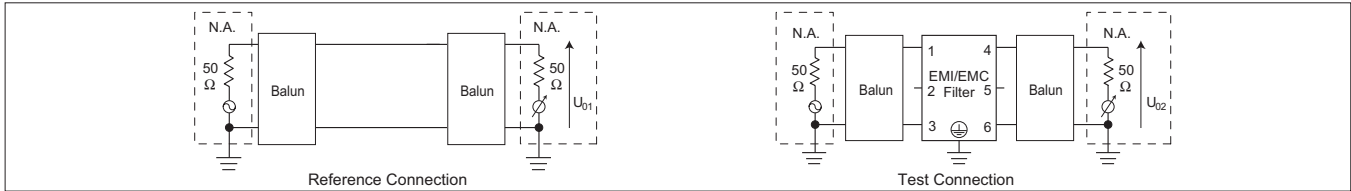

■ Object product : Three phase input type (Common mode)

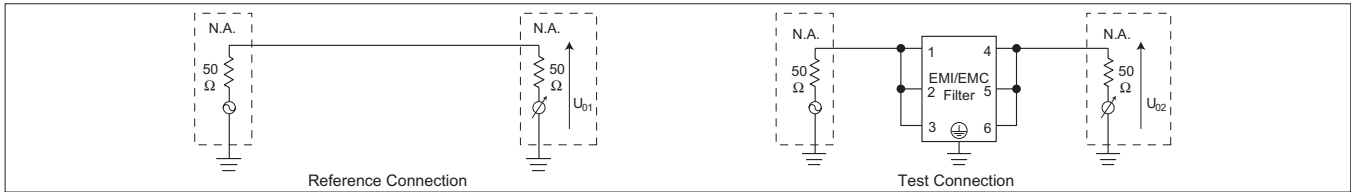

■ Object product : DC input type (Differential mode)

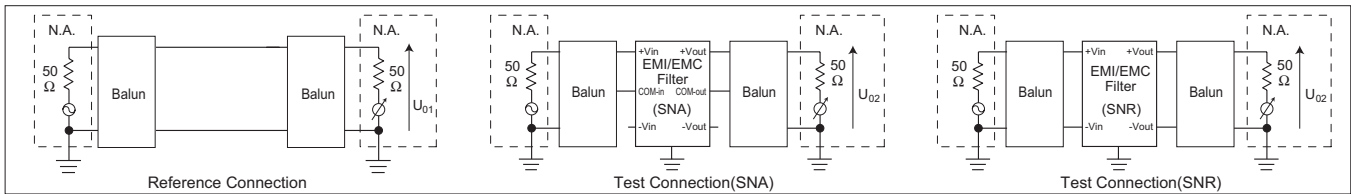

■ Object product : DC input type (Common mode)

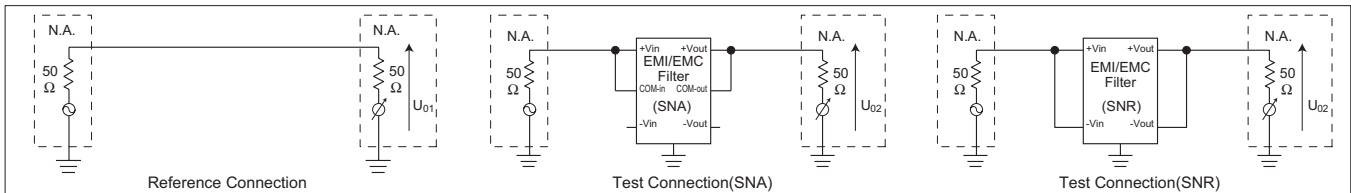

### (2) Pulse Attenuation Characteristic

