

5

Interface technology and switching devices

2019/2020



Terminal blocks

- Terminal blocks



Interface technology and switching devices

- Electronic switching devices and motor control
- Measurement and control technology
- Monitoring
- Relay modules
- System cabling for controllers



Sensor/actuator cabling and connectors

- Sensor/actuator cabling
- Cables and lines
- Connectors



Automation

- PLCnext Technology
- Industrial cloud computing
- Software
- PLCs and I/O systems
- Functional safety
- Industrial communication technology
- HMIs and industrial PCs
- Lighting and signaling



Marking systems, tools, and mounting material

- Marking and labeling
- Tools
- Installation and mounting material



Charging technology for electromobility

- Charging technology for electromobility



Surge protection, power supplies, and device circuit breakers

- Surge protection and interference suppression filters
- Power supplies and UPS
- Protective devices



PCB terminal blocks and PCB connectors

Use our E-paper for quick product selection.

i Web code: #1517

Find out more with the web code

For detailed information, use the web codes provided in this brochure. Simply enter # and the four-digit number in the search field on our website.

i Web code: #1234 (example)

Or use the direct link:
phoenixcontact.net/webcode/#1234

You will find the latest information including all the new products directly in the product area of our website:

phoenixcontact.net/products

You can also use the Phoenix Contact catalog app interactively on your tablet.



Table of contents

Illustrated product range overview

Access the right product more quickly from here

4

COMPLETE line

The comprehensive solution for the control cabinet

8

Electronic switching devices and motor control



10

Measurement and control technology



56

Monitoring



194

Relay modules



268

System cabling for controllers



458

Technical information / index

580

Complete overview

Product range overview

Electronic switchgear and motor control



Motor management

Page 14



Hybrid motor starters

Page 22



Solid-state contactors

Page 40



Power distribution boards

Page 50



Termination Carrier system cabling

Page 170



Process indicators and field devices

Page 180

Monitoring



EMPro energy measuring devices for installation in front panel

Page 202



Three-phase energy meters

Page 204



Current transducers, current protectors

Page 226



MCR voltage transducers for AC and DC voltages up to 660 V

Page 238



SOLARCHECK Photovoltaic string monitoring

Page 240



Compact monitoring relays

Page 246



Special function modules

Page 266

Measurement and control technology



Highly-compact signal conditioners with plug-in connection technology
Page 66



Signal conditioners with functional safety
Page 116



Ex i signal conditioners with functional safety
Page 142



Multiplexers for HART signals
Page 172



Complete packages for data logging
Page 207



Current transformers
Page 208



Current transformers for retrofitting
Page 220



PACT-RCP...UV current transformers for retrofitting with UV protection
Page 224



Ultra-narrow timer relays
Page 260



Ultra-narrow multifunctional timer relays
Page 262



Multifunctional monitoring relays
Page 250



Multifunctional timer relays
Page 264

Complete overview

Product range overview

Relay modules



RIFLINE complete

Page 280



PLC-INTERFACE

Page 360



PLC logic programmable logic relay system

Page 428



DEK series

Page 438

System cabling for controllers



Controller-specific system cabling

Page 468



V8 adapters

Page 528



Retrofit and modernization components

Page 538



Universal modules

Page 548



Safety devices
See Catalog 6



Universal cables

Page 562



Potential distributors

Page 578

COMPLETE line

The comprehensive solution for the control cabinet

Easy planning, intuitive installation



COMPLETE line is a system comprising technologically leading and coordinated hardware and software products, consulting services, and system solutions that help you optimize your processes in control cabinet manufacturing. Engineering, purchasing, installation, and operation become significantly easier for you.

Your advantages at a glance:

- Intuitive handling, thanks to the uniform design, look, and function
- Time savings across the entire engineering process, thanks to consistent software support
- Reduced logistics costs with standardized accessories and reduced variety of parts
- Optimized processes in control cabinet manufacturing, thanks to custom services and innovative manufacturing solutions



Comprehensive product portfolio

With COMPLETE line, we offer a complete product portfolio of technologically leading products. These include:

- Controllers and I/O modules
- Power supplies and device circuit breakers
- Terminal blocks and distribution blocks
- Relay modules and motor starters
- Signal conditioners
- Safety technology
- Surge protection
- Heavy-duty connectors



Intuitive handling

Thanks to the simple, intuitive handling of the coordinated hardware components, you will save time during installation, startup, and maintenance. Push-in connection technology enables you to wire applications quickly – without using tools. The broad, technologically leading product portfolio will always provide you with the right product for standard or special applications.



Time savings across the entire engineering process

The PROJECT complete planning and marking software supports the entire control cabinet manufacturing process. The program features an intuitive user interface and enables the individual planning, automatic checking, and direct ordering of terminal strips.



Reduced logistics costs

Reduced variety of parts, thanks to standardized marking, bridging, and testing accessories. The COMPLETE line system coordinates products, design, and accessories enabling you to benefit from maximum reusability, thus reducing your logistics costs.



Optimized processes in control cabinet manufacturing

From engineering through to manufacturing, COMPLETE line supports you in making your control cabinet production as efficient as possible, thus creating a customized concept for optimizing your processes in control cabinet manufacturing. Our terminal strip production helps you to flexibly manage peak order times or to supply your control cabinet production with fully assembled DIN rails just-in-time.



Additional information:

Find out more about COMPLETE line and your comprehensive solutions for the control cabinet. Visit our website:

phoenixcontact.com/completeline



Electronic switchgear and motor control

Switching devices for starting, reversing, and protecting electric motors rank among the components used in automation technology. These components are designed redundantly for safety-sensitive applications. When it comes to reducing installation time and space requirements, CONTACTRON hybrid motor starters are the state-of-the-art alternative.

This is because CONTACTRON hybrid motor starters combine up to four functions in a single device. They are integrated into popular fieldbus systems via the Interface system connection.

For protection of the entire system, the product range now includes the electronic motor manager (EMM). In addition to typical measured values such as voltage and current, the behavior of the system is monitored and protected by means of active power measurement. The process data in all popular fieldbus systems can be supplied with the gateway and evaluated by a controller.

Product range overview

Product overview	12
Electronic motor management	14
Network-capable hybrid motor starters with reversing function	24
Modular hybrid motor starters with reversing function	26
Hybrid motor starters with reversing function	28
Network-capable hybrid motor starters with direct start function	30
Modular hybrid motor starters with direct start function	32
Hybrid motor starters with direct start function	34
Hybrid motor starters with short-circuit protection	37
3-phase solid-state reversing contactors	40
3-phase solid-state contactors	42
Solid-state reversing contactors for DC motors	46
Single-phase solid-state contactors	48
Power distribution boards	50

Product overview

Motor management



Electronic motor management
Page 16



Gateways
Page 20



IFS extension modules for the
Interface system
Page 21

Hybrid motor starters



Network-capable hybrid motor starters
with reversing function
Page 24



Hybrid motor starters with reversing function
Page 28



Network-capable hybrid motor starters
with direct start function
Page 30



Hybrid motor starters with direct start
function
Page 34

Solid-state contactors



3-phase solid-state reversing contactors
Page 40



3-phase solid-state contactors
Page 42



Solid-state reversing contactors for
DC motors
Page 46



Single-phase solid-state contactors
Page 48



Hybrid motor starters with short-circuit protection

Page 37



Loop bridges for hybrid motor starters

Page 38

Power distribution boards



Power distribution boards

Page 50



Electronic motor management (EMM)

The electronic motor management modules offer all the advantages of modern active power monitoring.

The measuring and evaluation electronics for all performance classes. EMM offers the same functionality for all performance classes, but without a power unit.

Power within limits

Monitoring is based on freely configurable switching and signaling thresholds for overload and underload detection. Identical or separate settings can be made for the thresholds for both directions of rotation. The active power consumed, calculated from three currents, voltages, and the phase angle, is used for configuration. As it is independent of voltage fluctuations and drive load, the configuration is thus much more precise than when only the current is taken into consideration. If a switching threshold is violated, an emergency shutdown of the motor is initiated immediately or with an adjustable “delay time”. In addition, a message is sent via an output.

This state can only be deactivated via a defined reset. If the effective power consumed is determined as being above or below the signaling thresholds, all that occurs is that a check-back is returned for the duration for which the module was addressed.

In addition, signals are generated by the module for the recognition of the direction of rotation. Asymmetry and phase failures are detected and signalized.

Permanent status monitoring with high scanning rates and the fast semiconductor switch enable complete system protection, including motor protection.

Without any extra wiring – and with just a single device – pumps, actuating drives, fans, and tools are monitored for proper functioning, contamination (filter or similar), and wear. The adjustable “inrush suppression” time can be used to mask out the switching operation from the monitoring process.

Interface system

The Interface system (IFS) consists of devices which can be connected to each other via the DIN rail connector. A gateway with up to 32 IFS devices forms the head of the Interface system. The station is managed by the gateway.

- Interface system properties:
- Use of the Interface system via the DIN rail connector for the purpose of configuration, diagnostics and exchange of data
 - Compatible with defined IFS accessories
 - 24 V supply of the devices (e.g., EMM...IFS, ELR...IFS, EM-GATEWAY-IFS) via the DIN rail connector



Protection against dry running, blocking, and cavitation, warning thresholds to indicate filter contamination.



Protection against blocking, warning thresholds for bearing wear and other cases that trigger overload.



Protection against blocking and broken tools, warning thresholds for tool and bearing wear.

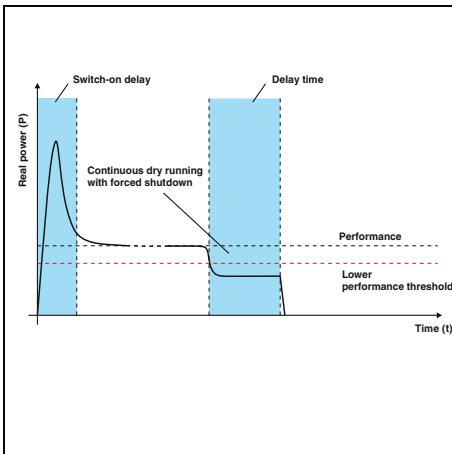

In the case of motor-driven pumps, the lower performance threshold provides reliable protection against hazardous dry running.

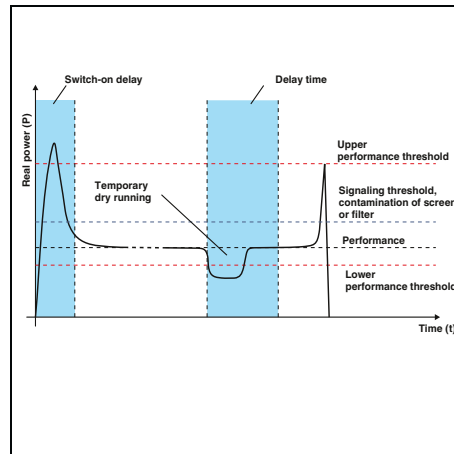

Forced shutdown of the drive is delayed by the "delay time".

This prevents forced shutdown in the event of air bubbles.

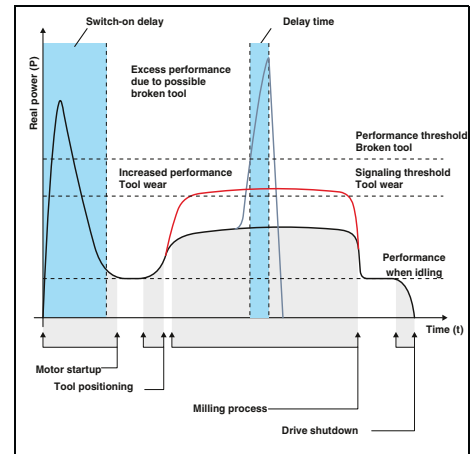

Machine tools are monitored and protected in a similar way when drilling, milling or grinding. If the feed value on a milling machine is set too high, a tool may break in the worst-case scenario. The power threshold, configured accordingly, can be used to resolve this issue.

Additionally, a signaling threshold signals tool wear in advance.

Motor management

Electronic motor management

EMM motor management (with or without current transformer) for all performance classes monitors and protects 3-phase loads, such as electrical drives.

- Freely configurable signaling or switching thresholds
- Digital outputs control external switching elements
- Optional connection to the Interface system (e.g., IFS gateways) via DIN rail connector



Allows the use of external current transformers



With integrated current transformers

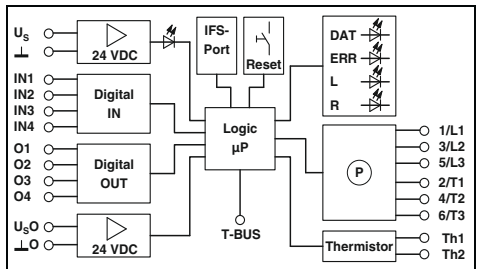
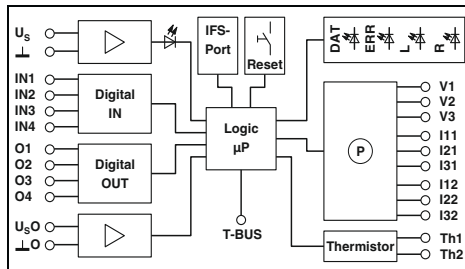

Technical data

Input data		
Rated control supply voltage U_s	24 V DC	230 V AC
Control supply voltage range	19.2 V DC ... 30 V DC	92 V AC ... 253 V AC
Rated control supply current I_s at U_s	25 mA	10 mA
Input data, digital inputs	EMM 3- 24DC/500AC-IFS	EMM 3-230AC/500AC-IFS
Number of inputs	4 (IN1 - IN4)	4 (IN1 - IN4)
Rated actuating voltage U_C	24 V DC	230 V AC
Rated actuating current I_C	3.3 mA	3.5 mA
Power measurement		
Voltage measuring input	42 V AC ... 575 V AC	42 V AC ... 575 V AC
Nominal current, voltage measuring input	<0.5 mA	<0.5 mA
Current measuring input	5 A (secondary external converter)	5 A (secondary external converter)
Output data, checkback contacts		
O1 - O4 in the case of 1 signal	24 V DC (semiconductor output) / 500 mA	230 V AC (relay output) / 500 mA
General data		
Rated insulation voltage	500 V	
Rated surge voltage	6 kV	6 kV
Ambient temperature (operation)	-25°C ... 70°C	
Standards/regulations	DIN EN 50178 / EN 60947 / EN 60947-4-2	
Degree of protection in accordance with IEC 60529/EN 60529	IP20	
Mounting position	Vertical (horizontal DIN rail)	
Screw connection rigid / flexible / AWG	0.2 - 2.5 mm ² / 0.2 - 2.5 mm ² / 24 - 14	
Dimensions	22.5 mm / 99 mm / 114.5 mm	
EMC note	Class A product, see page 583	

Technical data

Input data		
Rated control supply voltage U_s	24 V DC	230 V AC
Control supply voltage range	19.2 V DC ... 30 V DC	92 V AC ... 253 V AC
Rated control supply current I_s at U_s	25 mA	10 mA
Input data, digital inputs	EMM 3- 24DC/500AC-16-IFS	EMM 3-230AC/500AC-16-IFS
Number of inputs	4 (IN1 - IN4)	4 (IN1 - IN4)
Rated actuating voltage U_C	24 V DC	230 V AC
Rated actuating current I_C	3.3 mA	3.5 mA
Power measurement		
Voltage measuring input	42 V AC ... 575 V AC	42 V AC ... 575 V AC
Nominal current, voltage measuring input	<0.5 mA	<0.5 mA
Current measuring input	max. 16 A	max. 16 A
Output data, checkback contacts		
O1 - O4 in the case of 1 signal	24 V DC (semiconductor output) / 500 mA	230 V AC (relay output) / 500 mA
General data		
Rated insulation voltage	500 V	
Rated surge voltage	6 kV	6 kV
Ambient temperature (operation)	-25°C ... 70°C	
Standards/regulations	DIN EN 50178 / EN 60947 / EN 60947-4-2	
Degree of protection in accordance with IEC 60529/EN 60529	IP20	
Mounting position	Vertical (horizontal DIN rail)	
Screw connection rigid / flexible / AWG	0.2 - 2.5 mm ² / 0.2 - 2.5 mm ² / 24 - 14	
Dimensions	22.5 mm / 99 mm / 114.5 mm	
EMC note	Class A product, see page 583	

Ordering data

Description	Type	Order No.	Pcs./Pkt.
Electronic motor management	EMM 3- 24DC/500AC-IFS	2297497	1
	EMM 3-230AC/500AC-IFS	2297507	1

Ordering data

Description	Type	Order No.	Pcs./Pkt.
Electronic motor management	EMM 3- 24DC/500AC-16-IFS	2297523	1
	EMM 3-230AC/500AC-16-IFS	2297536	1

Accessories

Configuration package for the EMM...IFS, comprising CONTACTRON-DTM-IFS, USB programming adapter, and user manual on CD	MM-CONF-SET	2297992	1
Programming adapter for configuring modules with S-PORT interface	IFS-USB-PROG-ADAPTER	2811271	1
DIN rail connector	ME 22,5 TBUS 1,5/ 5-ST-3,81 GY	2201937	50
Voltage transducer for 690 V , for EMM 3-.../500AC-IFS, comprising 3 modular terminal blocks and cover	UT 4-MTD-R/CVC 690/SET	2901667	1
Multi-functional memory block for the Interface system			
- Flat design	IFS-CONFSTICK	2986122	1
- Tall design	IFS-CONFSTICK-L	2901103	1
MINI COMBICON connectors			
- Female contact	MC 1,5/ 5-ST-3,81	1803604	250
- Male contact	IMC 1,5/ 5-ST-3,81	1857919	50

Accessories

Configuration package for the EMM...IFS, comprising CONTACTRON-DTM-IFS, USB programming adapter, and user manual on CD	MM-CONF-SET	2297992	1
Programming adapter for configuring modules with S-PORT interface	IFS-USB-PROG-ADAPTER	2811271	1
DIN rail connector	ME 22,5 TBUS 1,5/ 5-ST-3,81 GY	2201937	50
Voltage transducer for 690 V , for EMM 3-.../500AC-IFS, comprising 3 modular terminal blocks and cover	UT 4-MTD-R/CVC 690/SET	2901667	1
Multi-functional memory block for the Interface system			
- Flat design	IFS-CONFSTICK	2986122	1
- Tall design	IFS-CONFSTICK-L	2901103	1
MINI COMBICON connectors			
- Female contact	MC 1,5/ 5-ST-3,81	1803604	250
- Male contact	IMC 1,5/ 5-ST-3,81	1857919	50

Electronic motor management

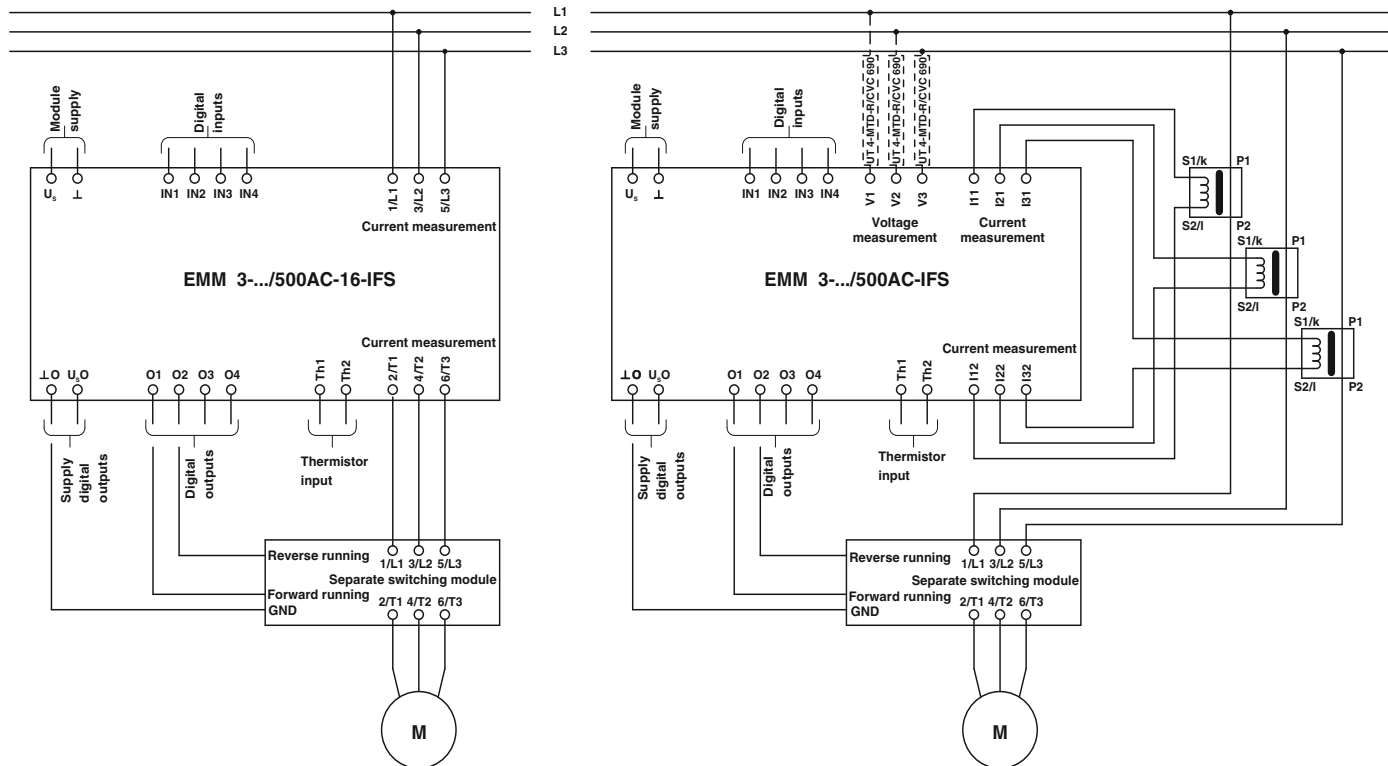

The electronic motor management modules (EMM) offer all the advantages of modern active power monitoring. Every 6.6 ms, the active power consumed by a drive system or another 3-phase load is determined based on three currents, voltages, and the phase angle. Currents up to 16 A are directly acquired and currents >16 A are fed through external converters. Separate mechanical or electronic switching elements, which take care of the actual load switching, are controlled via digital outputs. The EMM is designed to reliably protect connected loads – irrespective of their power consumption – against overload and underload, and to provide continuous status monitoring.

Up to 8 freely configurable switching, signaling thresholds and up to four freely configurable inputs and outputs enable the protection of electrical drives and the system.

The EMM modules can record the following data:

- Apparent, active, and reactive power
- Currents and voltages
- Phase angle
- Switching-cycle and operating-hour meters
- Power meter
- Additional functions:
 - Adjustable Class 5-40 bimetal function
 - Thermistor monitoring
 - Recording measured values
 - GATEWAY connection via DIN rail connector
- Pre-configured motor feeders such as reversing starters, star-delta starters, etc.

With the EMM modules, complete “driving curves” are recorded, which can be used for the system documentation, for example.

With the forward running, reverse running, reversing, and limit switch (with integrated restart lock) operating modes, actuators and control drives, pumps and similar are switched and monitored for wear.

Current transformer

The external converters should be selected with a secondary nominal current of 5 A. The primary current is determined by the current consumption of the load (refer to connection diagram). Refer to the Interface catalog for suitable current transformers.

DIN rail connectors

The DIN rail connector (Order No. 2201937) is used to supply several EMMs with 24 V DC or to couple up to 32 EMMs to the EM-PROFINET-GATEWAY-IFS, for example.

Switching element

Depending on the requirements for the actual load switching, an electromechanical contactor or a reversing contactor combination or a solid-state contactor/ solid-state reversing contactor is used. These switching elements are controlled via the digital outputs of the EMM modules.

Motor management

Electronic machine management

Phoenix Contact's electronic motor and machine management combines precise energy measurement with display and monitoring for important parameters for motors, machines or other 3-phase loads.

- Flexible use in the central control cabinet and in the decentral control box
- Increased system availability, thanks to predictive maintenance based on process data
- Continuous monitoring of mixed loads within an application
- Connects directly via DIN rail connector interfaces to all standard fieldbus systems

new



With external current transformers up to 90 A

new



With external current transformers up to 160 A

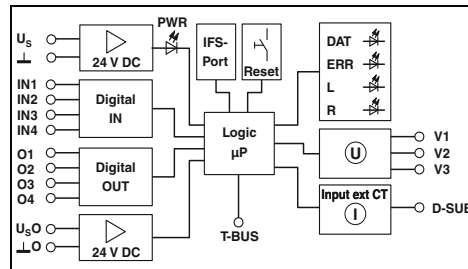

Technical data

Input data	
Rated control supply voltage U_s	24 V DC
Control supply voltage range	19.2 V DC ... 30 V DC
Rated control supply current I_s at U_s	33 mA
Input data, digital inputs	
Number of inputs	4 (IN1 - IN4)
Rated actuating voltage U_C	24 V DC
Rated actuating current I_C	3.3 mA
Power measurement	
Voltage measuring input	-
Nominal current, voltage measuring input	-
Current measuring input	-
Output data, checkback contacts	
O1 - O4 in the case of 1 signal	24 V DC (semiconductor output) / 500 mA
General data	
Rated insulation voltage	500 V
Rated surge voltage	6 kV
Ambient temperature (operation)	-25°C ... 50°C
Standards/regulations	EN 60947-1 / EN 60947-4-2 / EN 61000-6-2 / EN 61000-6-3
Degree of protection in accordance with IEC 60529/EN 60529	IP20
Mounting position	Any
Screw connection rigid / flexible / AWG	0.14 - 2.5 mm ² / 0.14 - 2.5 mm ² / 26 - 12
Dimensions	W / H / D 22.5 mm / 99 mm / 114.5 mm

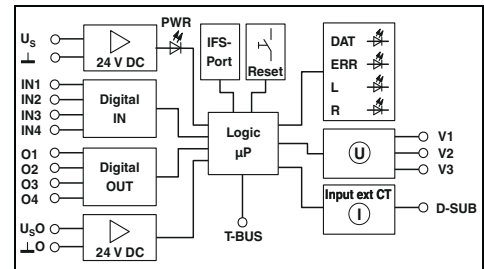

Technical data

Input data	
Rated control supply voltage U_s	24 V DC
Control supply voltage range	19.2 V DC ... 30 V DC
Rated control supply current I_s at U_s	33 mA
Input data, digital inputs	
Number of inputs	4 (IN1 - IN4)
Rated actuating voltage U_C	24 V DC
Rated actuating current I_C	3.3 mA
Power measurement	
Voltage measuring input	-
Nominal current, voltage measuring input	-
Current measuring input	-
Output data, checkback contacts	
O1 - O4 in the case of 1 signal	24 V DC (semiconductor output) / 500 mA
General data	
Rated insulation voltage	500 V
Rated surge voltage	6 kV
Ambient temperature (operation)	-25°C ... 70°C
Standards/regulations	EN 60947-1 / EN 60947-4-2 / EN 61000-6-2 / EN 61000-6-3
Degree of protection in accordance with IEC 60529/EN 60529	IP20
Mounting position	Any
Screw connection rigid / flexible / AWG	0.14 - 2.5 mm ² / 0.14 - 2.5 mm ² / 26 - 12
Dimensions	W / H / D 22.5 mm / 99 mm / 114.5 mm

Ordering data

Description	Type	Order No.	Pcs./Pkt.
Electronic motor management			
- With external current transformers (90 A)	EMM 3-24DC/500AC-90-EXM-IFS	2908602	1
- With external current transformers (160 A)			

Ordering data

Description	Type	Order No.	Pcs./Pkt.
Electronic motor management			
- With external current transformers (160 A)	EMM 3-24DC/500AC-160-EXM-IFS	2908603	1

Accessories

Description	Type	Order No.	Pcs./Pkt.
Configuration package for the EMM...IFS, comprising CONTACTRON-DTM-IFS, USB programming adapter, and user manual on CD	MM-CONF-SET	2297992	1
Programming adapter for configuring modules with S-PORT interface	IFS-USB-PROG-ADAPTER	2811271	1
DIN rail connector	ME 22,5 TBUS 1,5/ 5-ST-3,81 GY	2201937	50
Assembled shielded round cable			
- 0.5 m	CABLE-D 9SUB/B/S/ 50/KONFEK/S	2299987	1
- 1.0 m	CABLE-D 9SUB/B/S/100/KONFEK/S	2299990	1
- 1.5 m	CABLE-D 9SUB/B/S/150/KONFEK/S	2300009	1
- 2.0 m	CABLE-D 9SUB/B/S/200/KONFEK/S	2302010	1
- 3.0 m	CABLE-D 9SUB/B/S/300/KONFEK/S	2302023	1
Multi-functional memory block for the Interface system			
- Flat design	IFS-CONFSTICK	2986122	1

Accessories

Description	Type	Order No.	Pcs./Pkt.
Configuration package for the EMM...IFS, comprising CONTACTRON-DTM-IFS, USB programming adapter, and user manual on CD	MM-CONF-SET	2297992	1
Programming adapter for configuring modules with S-PORT interface	IFS-USB-PROG-ADAPTER	2811271	1
DIN rail connector	ME 22,5 TBUS 1,5/ 5-ST-3,81 GY	2201937	50
Assembled shielded round cable			
- 0.5 m	CABLE-D 9SUB/B/S/ 50/KONFEK/S	2299987	1
- 1.0 m	CABLE-D 9SUB/B/S/100/KONFEK/S	2299990	1
- 1.5 m	CABLE-D 9SUB/B/S/150/KONFEK/S	2300009	1
- 2.0 m	CABLE-D 9SUB/B/S/200/KONFEK/S	2302010	1
- 3.0 m	CABLE-D 9SUB/B/S/300/KONFEK/S	2302023	1
Multi-functional memory block for the Interface system			
- Flat design	IFS-CONFSTICK	2986122	1



Motor management

IFS gateways for Interface system devices

EM...GATEWAY-IFS for connecting Interface system devices (IFS) to popular bus systems: PROFIBUS DP, Modbus, Modbus/TCP, CANopen®, and PROFINET, EtherNet/IP™.

- Communication via DIN rail connector with up to 32 Interface system devices, such as EMM...IFS- and ELR...IFS modules
- Equipped with freely configurable digital inputs and outputs
- Digital switching outputs for direct control



IFS gateway

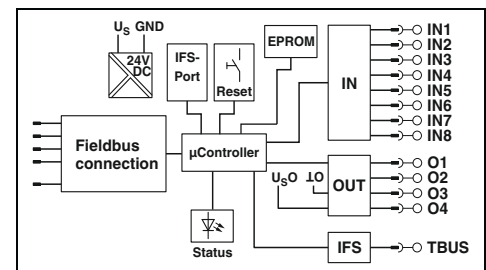

Technical data

Input data	
Rated control supply voltage U_s	24 V DC -20% ... +25%
Rated control supply current I_s	85 mA (plus load current of the outputs)
Input circuit	Reverse polarity protection
Digital inputs	
Number of inputs	8
Rated actuating voltage U_C	24 V DC $\pm 20\%$
Rated actuating current I_C	3 mA
Input circuit	Reverse polarity protection
Digital outputs	
Number of outputs	4
Maximum switching voltage	23 V DC ($U_B - U_{resid.}$ of the output)
Max. switching current	500 mA
Residual voltage	1 V
Output protection	Parallel protection against polarity reversal, note fusing
General data	
Ambient temperature (operation)	-35°C ... 50°C
Nominal operating mode	100% operating factor
Standards/regulations	EN 50178
Degree of protection	IP20
Mounting position/mounting	Any / in rows with zero spacing
Connection data solid/stranded/AWG	0.2 ... 2 mm ² / 0.2 ... 2.5 mm ² / 12 - 24
Dimensions	22.5 mm / 99 mm / 114.5 mm
EMC note	Class A product, see page 583

Ordering data

Description	Type	Order No.	Pcs./Pkt.
IFS gateway for PROFIBUS DP	EM-PB-GATEWAY-IFS	2297620	1
Modbus/TCP	EM-MODBUS-GATEWAY-IFS	2901528	1
CANopen®	EM-CAN-GATEWAY-IFS	2901504	1
PROFINET	EM-PNET-GATEWAY-IFS	2904472	1
EtherNet/IP™	EM-ETH-GATEWAY-IFS	2901988	1

Accessories

Configuration package for the EMM...IFS, comprising CONTACTRON-DTM-IFS, USB programming adapter, and user manual on CD	MM-CONF-SET	2297992	1
Programming adapter for configuring modules with S-PORT interface	IFS-USB-PROG-ADAPTER	2811271	1
DIN rail connector	ME 22,5 TBUS 1,5/ 5-ST-3,81 GY	2201937	50
MINI COMBICON connectors			
- Female contact	MC 1,5/ 5-ST-3,81	1803604	250
- Male contact	IMC 1,5/ 5-ST-3,81	1857919	50

IFS extension modules for the Interface system

EM-D-8/4... IFS digital extension modules for the Interface system (IFS). For more complex applications, in order to process additional signals in the field.

- Communication with an IFS gateway via DIN rail connector as the slave
- Freely configurable digital inputs and outputs



IFS extension module

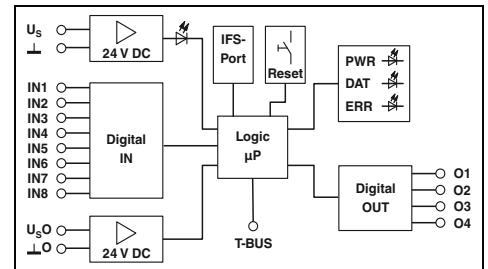

Technical data

Input data	
Rated control supply voltage U_s	24 V DC -20% ... +25%
Rated control supply current I_s	85 mA (plus load current of the outputs)
Input circuit	Reverse polarity protection
Digital inputs	
Number of inputs	8
Rated actuating voltage U_c	24 V DC $\pm 20\%$
Rated actuating current I_c	3 mA
Input circuit	Reverse polarity protection
Digital outputs	
Number of outputs	4
Maximum switching voltage	23 V DC ($U_B - U_{resid.}$ of the output)
Max. switching current	500 mA (per output)
Residual voltage	1 V
Output protection	Parallel protection against polarity reversal, note fusing
General data	
Ambient temperature (operation)	-35°C ... 50°C
Nominal operating mode	100% operating factor
Standards/regulations	EN 61131-2
Degree of protection	IP20
Mounting position/mounting	Any / in rows with zero spacing
Connection data solid/stranded/AWG	0.2 ... 2 mm ² / 0.2 ... 2.5 mm ² / 12 - 24
Dimensions	22.5 mm / 99 mm / 114.5 mm

Technical data		
Rated control supply voltage U_s	24 V DC -20% ... +25%	
Rated control supply current I_s	85 mA (plus load current of the outputs)	
Input circuit	Reverse polarity protection	
Digital inputs		
Number of inputs	8	
Rated actuating voltage U_c	24 V DC $\pm 20\%$	
Rated actuating current I_c	3 mA	
Input circuit	Reverse polarity protection	
Digital outputs		
Number of outputs	4	
Maximum switching voltage	23 V DC ($U_B - U_{resid.}$ of the output)	
Max. switching current	500 mA (per output)	
Residual voltage	1 V	
Output protection	Parallel protection against polarity reversal, note fusing	
General data		
Ambient temperature (operation)	-35°C ... 50°C	
Nominal operating mode	100% operating factor	
Standards/regulations	EN 61131-2	
Degree of protection	IP20	
Mounting position/mounting	Any / in rows with zero spacing	
Connection data solid/stranded/AWG	0.2 ... 2 mm ² / 0.2 ... 2.5 mm ² / 12 - 24	
Dimensions	22.5 mm / 99 mm / 114.5 mm	

Ordering data

Description
IFS extension module, with 8 digital inputs and 4 digital outputs

Type	Order No.	Pcs./Pkt.
EM-D-8/4-24DC-IFS	2904473	1

Accessories

Configuration package for the EMM...IFS, comprising CONTACTRON-DTM-IFS, USB programming adapter, and user manual on CD
Programming adapter for configuring modules with S-PORT interface
DIN rail connector
MINI COMBICON connectors
- Female contact
- Male contact

Accessories	Order No.	Pcs./Pkt.
MM-CONF-SET	2297992	1
IFS-USB-PROG-ADAPTER	2811271	1
ME 22,5 TBUS 1,5/ 5-ST-3,81 GY	2201937	50
MC 1,5/ 5-ST-3,81	1803604	250
IMC 1,5/ 5-ST-3,81	1857919	50



The CONTACTRON hybrid motor starters combine up to four functions in one device: motor starter, reversing function, motor protection against overload, and emergency stop.

In addition to standard devices for parallel wiring, network-capable versions, which can be integrated into fieldbus environments, are also available.

CONTACTRON hybrid motor starter technology is a microprocessor-controlled combination of wear-free solid-state technology and robust relay technology. The semiconductors execute the wear-prone on and off switching procedures, while the relays only conduct low-loss current. This enables soft switching and considerably reduces the load on the relay contacts.

Switch motors safely and reliably with compact hybrid motor starters.

The devices are used wherever three-phase asynchronous motors, from 50 W to 3 kW, need to be reversed and protected. The product range of hybrid motor starters consists of direct and reversing starters, which are available with various functions such as emergency stop and motor protection.



Hybrid motor starters with up to four functions in one device: forward running, reverse running, motor protection, and emergency stop.



Short-circuit-proof hybrid motor starters with integrated fuses, for mounting on 35 mm DIN rail and 60 mm busbar systems.



Connection of the hybrid motor starters to a bus system via the IFS Interface system. Gateways are available for the most important bus systems: PROFIBUS DP, Modbus/TCP, EtherNet/IP™, CANopen®, PROFINET, etc.

Hybrid motor starters

Network-capable hybrid motor starters with reversing function

These 3-phase hybrid motor starters offer up to four functions: forward running, reverse running, motor protection, and emergency stop up to SIL 3 / PL e.

Featuring the following advantages:

- Bus connection via Interface system (IFS) or via IO-Link
 - Diagnostic functions using process data
 - Reduced wiring effort
 - Bi-metal function, adjustable up to 9 A
 - Long service life
 - Space-saving
 - 3-phase loop bridging
- Safety level in accordance with:
- IEC 61508-1: SIL 3
 - ISO 13849: PL e

Notes:
Type of insulating housing: Polyamide PA non-reinforced, color: gray.
Marking systems and mounting material See Catalog 3



Motor protection, emergency stop and Interface system support

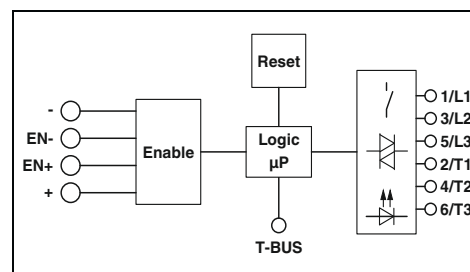

Technical data

Input data	Rated control supply voltage U_s	24 V DC
Control supply voltage range	19.2 V DC ... 30 V DC	
Rated control supply current I_s at U_s	60 mA	
Rated actuating voltage U_c EN+	24 V DC	
Actuating voltage range	19.2 V DC ... 30 V DC	
Rated actuating current I_c at U_c	7 mA	
Input circuit	Surge protection, reverse polarity protection	
Operating voltage / status / error indicator	Green LED / Yellow LED / Red LED	
Output data load side		
Operating voltage range	42 V AC ... 550 V AC	
Output protection	Surge protection	
General data		
Rated insulation voltage	550 V	
Rated surge voltage	6 kV	
Ambient temperature (operation)	-5°C ... 60°C (observe derating)	
Standards/regulations	IEC 60947-1 / EN 60947-4-2 / IEC 61508 / ISO 13849	
Mounting position	Vertical (horizontal DIN rail, motor output below)	
Mounting	Alignable, for spacing see derating	
Connection data solid/stranded/AWG	0.2 - 2.5 mm ² / 0.2 - 2.5 mm ² / 24 - 14	
Dimensions	22.5 mm / 106.6 mm / 113.7 mm	

Ordering data

Description	Type	Order No.	Pcs./Pkt.
Load current 0.075 A ... 0.6 A			
Screw connection	ELR H5-IES-SC/500AC-06-IFS	2905151	1
Push-in connection	ELR H5-IES-PT/500AC-06-IFS	2905138	1
Load current 0.18 A ... 3 A			
Screw connection	ELR H5-IES-SC/500AC-3-IFS	2905152	1
Push-in connection	ELR H5-IES-PT/500AC-3-IFS	2905139	1
Load current 1.5 A ... 9 A			
Screw connection	ELR H5-IES-SC/500AC-9-IFS	2905153	1
Push-in connection	ELR H5-IES-PT/500AC-9-IFS	2905140	1

Accessories

DIN rail connector	ME 22,5 TBUS 1,5/ 5-ST-3,81 GY	2201937	50
--------------------	--------------------------------	---------	----

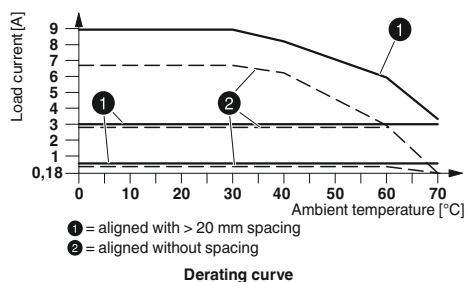



Motor protection and Interface system support



Motor protection, emergency stop and IO-Link support

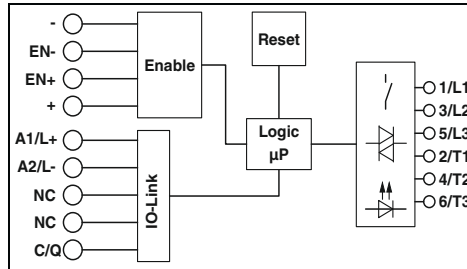
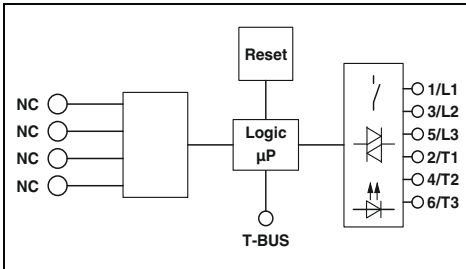

Technical data

24 V DC
19.2 V DC ... 30 V DC
60 mA
-
-
Surge protection, reverse polarity protection
Green LED / Yellow LED / Red LED

42 V AC ... 550 V AC
Surge protection

550 V
6 kV
-5°C ... 60°C (observe derating)
IEC 60947-1 / EN 60947-4-2
Vertical (horizontal DIN rail, motor output below)

Alignable, for spacing see derating
0.2 - 2.5 mm² / 0.2 - 2.5 mm² / 24 - 14
22.5 mm / 106.6 mm / 113.7 mm

Technical data

24 V DC
19.2 V DC ... 30 V DC
65 mA
24 V DC
19.2 V DC ... 30 V DC
7 mA
Surge protection, reverse polarity protection
Green LED / Yellow LED / Red LED

42 V AC ... 550 V AC
Surge protection

550 V
6 kV
-5°C ... 55°C (observe derating)
IEC 60947-1 / EN 60947-4-2 / IEC 61508 / ISO 13849
Vertical (horizontal DIN rail, motor output below)

Alignable, for spacing see derating
0.2 - 2.5 mm² / 0.2 - 2.5 mm² / 24 - 14
22.5 mm / 126.8 mm / 113.7 mm

Ordering data

Type	Order No.	Pcs./Pkt.
ELR H5-I-SC/500AC-06-IFS	2905157	1
ELR H5-I-PT/500AC-06-IFS	2905144	1
ELR H5-I-SC/500AC-3-IFS	2905159	1
ELR H5-I-PT/500AC-3-IFS	2905146	1
ELR H5-I-SC/500AC-9-IFS	2905160	1
ELR H5-I-PT/500AC-9-IFS	2905147	1

Accessories

ME 22.5 TBUS 1,5/ 5-ST-3,81 GY	2201937	50
--------------------------------	---------	----

Ordering data

Type	Order No.	Pcs./Pkt.
ELR H5-IES-PT/500AC-3-IOL	2908669	1
ELR H5-IES-PT/500AC-9-IOL	2908670	1

Accessories

--	--	--

Hybrid motor starters

Modular hybrid motor starters with reversing function

In addition to the functions forward running, reverse running, motor protection, and emergency stop up to SIL 3/PL e, these modular 3-phase hybrid motor starters offer additional advantages such as:

- Safe group switch-off
- Modular expansion option
- Wiring and cost savings with DIN rail connector
- Slow tripping characteristic curve
Class 10 up to 3 A
- Safety level in accordance with:
 - IEC 61508-1: SIL 3
 - ISO 13849: PL e

Notes:
Type of insulating housing: Polyamide PA non-reinforced, color: gray.
Marking systems and mounting material See Catalog 3



new

Motor protection, emergency stop

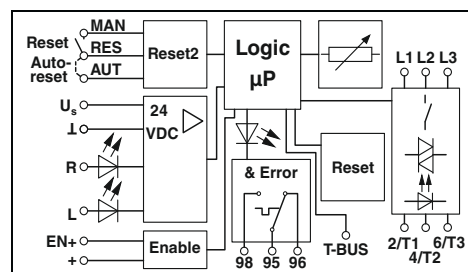

Technical data

Input data	
Rated control supply voltage U_s	24 V DC
Control supply voltage range	19.2 V DC ... 30 V DC
Rated control supply current I_s at U_s	60 mA
Rated actuating voltage U_c EN+	24 V DC
Actuating voltage range	19.2 V DC ... 30 V DC
Rated actuating current I_c at U_c	7 mA
Input circuit	Surge protection, reverse polarity protection
Operating voltage / status / error indicator	Green LED / Yellow LED / Red LED
Output data load side	
Operating voltage range	42 V AC ... 550 V AC
Output protection	Surge protection
General data	
Rated insulation voltage	550 V
Rated surge voltage	6 kV
Ambient temperature (operation)	-25°C ... 70°C (observe derating)
Standards/regulations	EN 60947-1 / EN 60947-4-2 / EN 50495 / EN ISO 13849 / IEC 62061 / IEC 61508
Mounting position	Vertical (horizontal DIN rail, motor output below)
Mounting	Alignable, for spacing see derating
Connection data solid/stranded/AWG	0.2 - 2.5 mm ² / 0.2 - 2.5 mm ² / 24 - 14
Dimensions	22.5 mm / 107.4 mm / 113.7 mm

24 V DC	
19.2 V DC ... 30 V DC	
60 mA	
24 V DC	
19.2 V DC ... 30 V DC	
7 mA	
Surge protection, reverse polarity protection	
Green LED / Yellow LED / Red LED	
42 V AC ... 550 V AC	
Surge protection	
550 V	
6 kV	
-25°C ... 70°C (observe derating)	
EN 60947-1 / EN 60947-4-2 / EN 50495 / EN ISO 13849 / IEC 62061 / IEC 61508	
Vertical (horizontal DIN rail, motor output below)	
Alignable, for spacing see derating	
0.2 - 2.5 mm ² / 0.2 - 2.5 mm ² / 24 - 14	
22.5 mm / 107.4 mm / 113.7 mm	

Ordering data

Description
Load current 0.18 A ... 3 A
Screw connection
Push-in connection
Load current 1.5 A ... 9 A
Screw connection
Push-in connection

Type	Order No.	Pcs./Pkt.
ELR H5-IES-PT- 24DC/500AC-3-P	2909556	1
ELR H5-IES-PT- 24DC/500AC-9-P	2909554	1

Accessories

Extension module
Screw connection
Push-in connection
Safety relay with interface for DIN rail connectors
Screw connection
Push-in connection
DIN rail connector
- For modular hybrid motor starters
- For safety relay modules

EM-2RSC/21AU-R/L-P	2908701	1
EM-2RPT/21AU-R/L-P	2909573	1
PSR-MC38-2NO-1DO-24DC-SC	1009831	1
PSR-MC38-2NO-1DO-24DC-PI	1009832	1
ELR-TBUS-22,5-P	2203861	10
PSR-TBUS	2890425	50



new



Motor protection, emergency stop

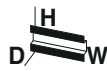

new



Motor protection

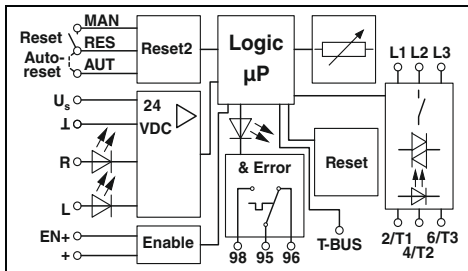

Technical data

24 V DC
19.2 V DC ... 30 V DC
60 mA
24 V DC
19.2 V DC ... 30 V DC
7 mA
Surge protection, reverse polarity protection
Green LED / Yellow LED / Red LED

42 V AC ... 550 V AC

550 V
6 kV
-25°C ... 70°C (observe derating)
EN 60947-1 / EN 60947-4-2 / EN ISO 13849 / IEC 62061 / IEC 61508
Vertical (horizontal DIN rail, motor output below)

Alignable, for spacing see derating
0.2 - 2.5 mm² / 0.2 - 2.5 mm² / 24 - 14
22.5 mm / 106.6 mm / 113.7 mm

Ordering data

Type	Order No.	Pcs./Pkt.
ELR H5-IS-SC- 24DC/500AC-3-P	2908699	1
ELR H5-IS-PT- 24DC/500AC-3-P	2909569	1
ELR H5-IS-SC- 24DC/500AC-9-P	2908697	1
ELR H5-IS-PT- 24DC/500AC-9-P	2909567	1

Accessories

EM-2RSC/21AU-R/L-P	2908701	1
EM-2RPT/21AU-R/L-P	2909573	1

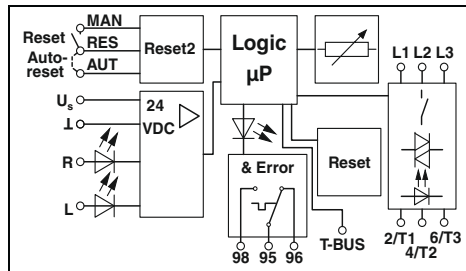

Technical data

24 V DC
19.2 V DC ... 30 V DC
60 mA
24 V DC
19.2 V DC ... 30 V DC
7 mA
Surge protection, reverse polarity protection
Green LED / Yellow LED / Red LED

42 V AC ... 550 V AC

550 V
6 kV
-25°C ... 55°C (observe derating)
IEC 60947-1 / EN 60947-4-2
Vertical (horizontal DIN rail, motor output below)

Alignable, for spacing see derating
0.2 - 2.5 mm² / 0.2 - 2.5 mm² / 24 - 14
22.5 mm / 106.6 mm / 113.7 mm

Ordering data

Type	Order No.	Pcs./Pkt.
ELR H5-I-SC- 24DC/500AC-3-P	2908695	1
ELR H5-I-PT- 24DC/500AC-3-P	2909562	1
ELR H5-I-SC- 24DC/500AC-9-P	2908693	1
ELR H5-I-PT- 24DC/500AC-9-P	2909560	1

Accessories

EM-2RSC/21AU-R/L-P	2908701	1
EM-2RPT/21AU-R/L-P	2909573	1

Hybrid motor starters

Hybrid motor starters with reversing function

These 3-phase hybrid motor starters offer up to four functions: forward running, reverse running, motor protection, and emergency stop up to SIL 3 / PL e.

Featuring the following advantages:

- 22.5 mm wide
- Reduced wiring effort
- Bi-metal function, adjustable up to 9 A
- Long service life
- Space-saving
- 3-phase loop bridging

Safety level in accordance with:

- IEC 61508-1: SIL 3
- ISO 13849: PL e

Notes:
Type of insulating housing: Polyamide PA non-reinforced, color: gray.
Marking systems and mounting material See Catalog 3



Motor protection and emergency stop

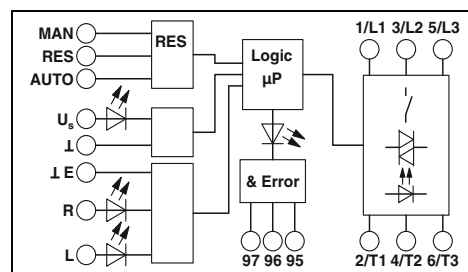

Technical data

Input data	24 V DC	230 V AC
Rated control supply voltage U_s	19.2 V DC ... 30 V DC	85 V AC ... 253 V AC
Control supply voltage range	40 mA	4 mA
Rated control supply current I_s at U_s	24 V DC	230 V AC
Rated actuating voltage U_c R/L	19.2 V DC ... 30 V DC	85 V AC ... 253 V AC
Actuating voltage range	5 mA (input type 1)	7 mA (input type 1)
Rated actuating current I_c at U_c	Surge protection, reverse polarity protection	Surge protection
Input circuit	Green LED / Yellow LED / Red LED	
Operating voltage / status / error indicator		
Output data load side		
Operating voltage range	42 V AC ... 550 V AC	42 V AC ... 550 V AC
Output protection	Surge protection	
General data		
Rated insulation voltage	500 V	
Rated surge voltage	6 kV	4 kV
Ambient temperature (operation)	-25°C ... 70°C (observe derating)	
Standards/regulations	IEC 60947-1 / IEC 60947-4-2 / IEC 61508 / ISO 13849	
Mounting position	Vertical (horizontal DIN rail, motor output below)	
Mounting	Alignable, for spacing see derating	
Connection data solid/stranded/AWG	0.2 - 2.5 mm ² / 0.2 - 2.5 mm ² / 24 - 14	
Dimensions	22.5 mm / 106.6 mm / 113.7 mm	

Ordering data

Description	Type	Order No.	Pcs./Pkt.
Load current 0.075 A ... 0.6 A			
Screw connection	ELR H5-IES-SC- 24DC/500AC-0,6	2900582	1
Push-in connection	ELR H5-IES-PT- 24DC/500AC-0,6	2903902	1
Load current 0.18 A ... 2.4 A			
Screw connection	ELR H5-IES-SC- 24DC/500AC-2	2900414	1
Push-in connection	ELR H5-IES-PT- 24DC/500AC-2	2903904	1
Screw connection	ELR H5-IES-SC-230AC/500AC-2	2900420	1
Load current 1.5 A ... 9 A			
Screw connection	ELR H5-IES-SC- 24DC/500AC-9	2900421	1
Push-in connection	ELR H5-IES-PT- 24DC/500AC-9	2903906	1
Screw connection	ELR H5-IES-SC-230AC/500AC-9	2900422	1
Load current 0 A ... 9 A			
Screw connection			
Screw connection			

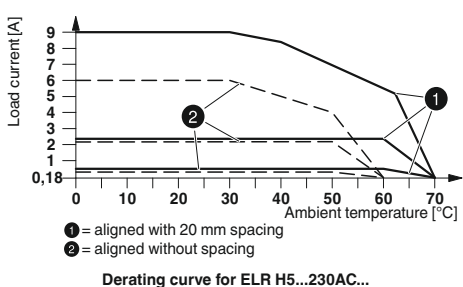
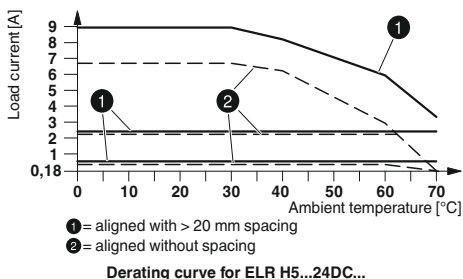



Motor protection

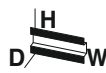

Reversing function only

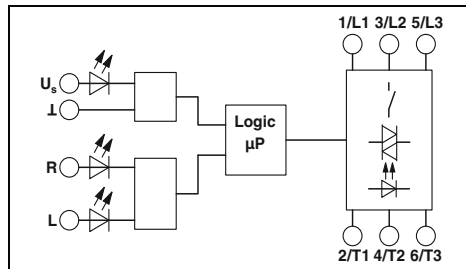
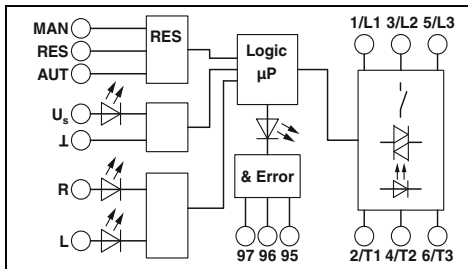

Technical data

24 V DC	230 V AC
19.2 V DC ... 30 V DC	85 V AC ... 253 V AC
40 mA	4 mA
24 V DC	230 V AC
19.2 V DC ... 30 V DC	85 V AC ... 253 V AC
5 mA (input type 1)	7 mA (input type 1)
Surge protection, reverse polarity protection	Surge protection
Green LED / Yellow LED / Red LED	

42 V AC ... 550 V AC	42 V AC ... 550 V AC
Surge protection	

500 V
6 kV 4 kV
-25°C ... 70°C (observe derating)
IEC 60947-1 / IEC 60947-4-2 / IEC 61508 / ISO 13849
Vertical (horizontal DIN rail, motor output below)

Alignable, for spacing see derating
0.2 - 2.5 mm² / 0.2 - 2.5 mm² / 24 - 14
22.5 mm / 106.6 mm / 113.7 mm

Ordering data

Type	Order No.	Pcs./Pkt.
ELR H5-I-SC- 24DC/500AC-0,6	2900573	1
ELR H5-I-PT- 24DC/500AC-0,6	2903908	1
ELR H5-I-SC- 24DC/500AC-2	2900574	1
ELR H5-I-PT- 24DC/500AC-2	2903910	1
ELR H5-I-SC-230AC/500AC-2	2900575	1
ELR H5-I-SC- 24DC/500AC-9	2900576	1
ELR H5-I-PT- 24DC/500AC-9	2903912	1
ELR H5-I-SC-230AC/500AC-9	2900578	1

Technical data

24 V DC	230 V AC
19.2 V DC ... 30 V DC	85 V AC ... 253 V AC
40 mA	4 mA
24 V DC	230 V AC
19.2 V DC ... 30 V DC	85 V AC ... 253 V AC
5 mA (input type 1)	7 mA (input type 1)
Surge protection, reverse polarity protection	Surge protection
Green LED / Yellow LED / -	

42 V AC ... 550 V AC	42 V AC ... 550 V AC
Surge protection	

500 V
6 kV 4 kV
-25°C ... 70°C (observe derating)
IEC 60947-1 / IEC 60947-4-2 / IEC 61508 / ISO 13849
Vertical (horizontal DIN rail, motor output below)

Alignable, for spacing see derating
0.2 - 2.5 mm² / 0.2 - 2.5 mm² / 24 - 14
22.5 mm / 106.6 mm / 113.7 mm

Ordering data

Type	Order No.	Pcs./Pkt.
ELR H5-SC- 24DC/500AC-9	2900538	1
ELR H5-SC-230AC/500AC-9	2900539	1

Hybrid motor starters

Network-capable hybrid motor starters with direct start function

These 3-phase hybrid motor starters offer up to three functions: forward running, motor protection, and emergency stop up to SIL 3 / PL e.

Featuring the following advantages:

- Bus connection via Interface system (IFS) or via IO-Link
 - Diagnostic functions using process data
 - Reduced wiring effort
 - Bi-metal function, adjustable up to 9 A
 - Long service life
 - Space-saving
 - 3-phase loop bridging
- Safety level in accordance with:
- IEC 61508-1: SIL 3
 - ISO 13849: PL e

Notes:
Type of insulating housing: Polyamide PA non-reinforced, color: gray.
Marking systems and mounting material See Catalog 3



Motor protection, emergency stop and Interface system support

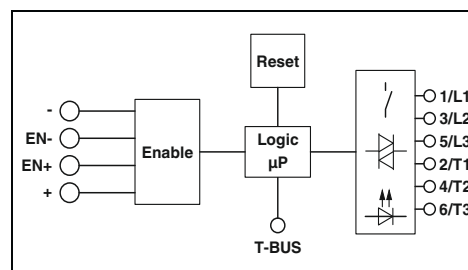

Technical data

Input data	24 V DC
Rated control supply voltage U_s	19.2 V DC ... 30 V DC
Control supply voltage range	60 mA
Rated control supply current I_s at U_s	24 V DC
Rated actuating voltage U_c EN+	19.2 V DC ... 30 V DC
Actuating voltage range	7 mA
Rated actuating current I_c at U_c	Surge protection, reverse polarity protection
Input circuit	Green LED / Yellow LED / Red LED
Operating voltage / status / error indicator	
Output data load side	
Operating voltage range	42 V AC ... 550 V AC
Output protection	Surge protection
General data	
Rated insulation voltage	550 V
Rated surge voltage	6 kV
Ambient temperature (operation)	-5°C ... 60°C (observe derating)
Standards/regulations	IEC 60947-1 / EN 60947-4-2 / IEC 61508 / ISO 13849
Mounting position	Vertical (horizontal DIN rail, motor output below)
Mounting	Alignable, for spacing see derating
Connection data solid/stranded/AWG	0.2 - 2.5 mm ² / 0.2 - 2.5 mm ² / 24 - 14
Dimensions	22.5 mm / 106.6 mm / 113.7 mm

Ordering data

Description	Type	Order No.	Pcs./Pkt.
Load current 0.075 A ... 0.6 A			
Screw connection	ELR H3-IES-SC/500AC-06-IFS	2905154	1
Push-in connection	ELR H3-IES-PT/500AC-06-IFS	2905141	1
Load current 0.18 A ... 3 A			
Screw connection	ELR H3-IES-SC/500AC-3-IFS	2905155	1
Push-in connection	ELR H3-IES-PT/500AC-3-IFS	2905142	1
Load current 1.5 A ... 9 A			
Screw connection	ELR H3-IES-SC/500AC-9-IFS	2905156	1
Push-in connection	ELR H3-IES-PT/500AC-9-IFS	2905143	1

Accessories

DIN rail connector	Order No.	Pcs./Pkt.
ME 22,5 TBUS 1,5/ 5-ST-3,81 GY	2201937	50

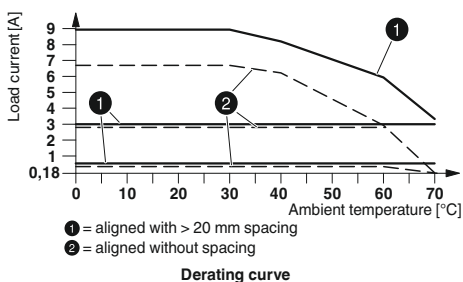



Motor protection and Interface system support

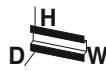

Motor protection, emergency stop and IO-Link support

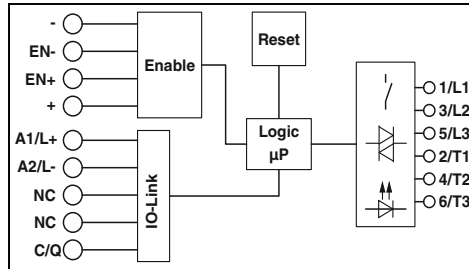
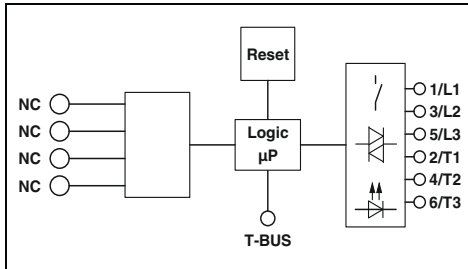

Technical data

24 V DC
19.2 V DC ... 30 V DC
60 mA
-
-
Surge protection, reverse polarity protection
Green LED / Yellow LED / Red LED

42 V AC ... 550 V AC
Surge protection

550 V
6 kV
-5°C ... 60°C (observe derating)
IEC 60947-1 / EN 60947-4-2
Vertical (horizontal DIN rail, motor output below)

Alignable, for spacing see derating
0.2 - 2.5 mm² / 0.2 - 2.5 mm² / 24 - 14
22.5 mm / 106.6 mm / 113.7 mm

Technical data

24 V DC
19.2 V DC ... 30 V DC
65 mA
24 V DC
19.2 V DC ... 30 V DC
7 mA
Surge protection, reverse polarity protection
Green LED / Yellow LED / Red LED

42 V AC ... 550 V AC
Surge protection

550 V
6 kV
-5°C ... 55°C (observe derating)
IEC 60947-1 / EN 60947-4-2 / IEC 61508 / ISO 13849
Vertical (horizontal DIN rail, motor output below)

Alignable, for spacing see derating
0.2 - 2.5 mm² / 0.2 - 2.5 mm² / 24 - 14
22.5 mm / 126.8 mm / 113.7 mm

Ordering data

Type	Order No.	Pcs./Pkt.
ELR H3-I-SC/500AC-06-IFS	2905162	1
ELR H3-I-PT/500AC-06-IFS	2905148	1
ELR H3-I-SC/500AC-3-IFS	2905163	1
ELR H3-I-PT/500AC-3-IFS	2905149	1
ELR H3-I-SC/500AC-9-IFS	2905164	1
ELR H3-I-PT/500AC-9-IFS	2905150	1

Accessories

ME 22.5 TBUS 1,5/ 5-ST-3.81 GY	2201937	50
--------------------------------	---------	----

Ordering data

Type	Order No.	Pcs./Pkt.
ELR H3-IES-PT/500AC-3-IOL	2908671	1
ELR H3-IES-PT/500AC-9-IOL	2908672	1

Accessories

--	--	--

Hybrid motor starters

Modular hybrid motor starters with direct start function

In addition to the functions forward running, motor protection, and emergency stop up to SIL 3/PL e, these modular 3-phase hybrid motor starters offer additional advantages such as:

- Safe group switch-off
- Modular expansion option
- Wiring and cost savings with DIN rail connector
- Slow tripping characteristic curve Class 10 up to 3 A
- Safety level in accordance with:
 - IEC 61508-1: SIL 3
 - ISO 13849: PL e

Notes:

Type of insulating housing:
Polyamide PA non-reinforced, color: gray.

Marking systems and mounting material
See Catalog 3



new

Motor protection, emergency stop

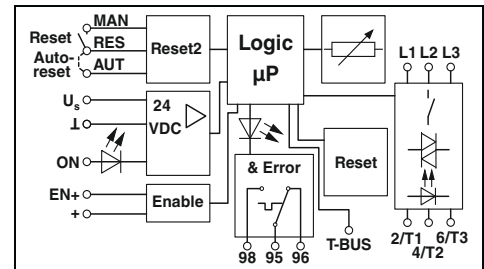

Technical data

Input data	Rated control supply voltage U_s	24 V DC
	Control supply voltage range	19.2 V DC ... 30 V DC
	Rated control supply current I_c at U_s	60 mA
	Rated actuating voltage U_c EN+	24 V DC
	Actuating voltage range	19.2 V DC ... 30 V DC
	Rated actuating current I_c at U_c	7 mA
	Input circuit	Surge protection, reverse polarity protection
	Operating voltage / status / error indicator	Green LED / Yellow LED / Red LED
Output data load side	Operating voltage range	42 V AC ... 550 V AC
	Output protection	Surge protection
General data	Rated insulation voltage	550 V
	Rated surge voltage	6 kV
	Ambient temperature (operation)	-25°C ... 70°C (observe derating)
	Standards/regulations	EN 60947-1 / EN 60947-4-2 / EN 50495 / EN ISO 13849 / IEC 62061 / IEC 61508
Mounting position		Vertical (horizontal DIN rail, motor output below)
Mounting	Connection data solid/stranded/AWG	Alignable, for spacing see derating 0.2 - 2.5 mm ² / 0.2 - 2.5 mm ² / 24 - 14
Dimensions		22.5 mm / 107.4 mm / 113.7 mm

Ordering data

Description	Type	Order No.	Pcs./Pkt.
Load current 0.18 A ... 3 A Screw connection Push-in connection	ELR H3-IES-PT- 24DC/500AC-3-P	2909557	1
Load current 1.5 A ... 9 A Screw connection Push-in connection	ELR H3-IES-PT- 24DC/500AC-9-P	2909555	1

Accessories

Description	Type	Order No.	Pcs./Pkt.
Extension module Screw connection Push-in connection	EM-2RSC/21AU-R/L-P EM-2RPT/21AU-R/L-P	2908701 2909573	1 1
Safety relay with interface for DIN rail connectors Screw connection Push-in connection	PSR-MC38-2NO-1DO-24DC-SC PSR-MC38-2NO-1DO-24DC-PI	1009831 1009832	1 1
DIN rail connector - For modular hybrid motor starters - For safety relay modules	ELR-TBUS-22,5-P PSR-TBUS	2203861 2890425	10 50



new



Motor protection, emergency stop



new



Motor protection

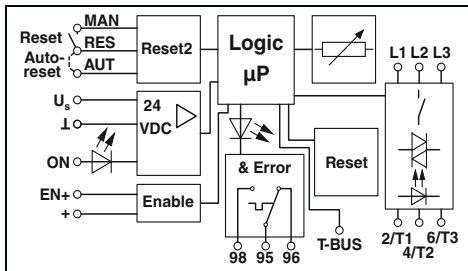

Technical data

24 V DC
19.2 V DC ... 30 V DC
60 mA
24 V DC
19.2 V DC ... 30 V DC
7 mA
Surge protection, reverse polarity protection
Green LED / Yellow LED / Red LED

42 V AC ... 550 V AC

550 V
6 kV
-25°C ... 70°C (observe derating)
EN 60947-1 / EN 60947-4-2 / EN ISO 13849 / IEC 62061 / IEC 61508
Vertical (horizontal DIN rail, motor output below)

Alignable, for spacing see derating
0.2 - 2.5 mm² / 0.2 - 2.5 mm² / 24 - 14
22.5 mm / 106.6 mm / 113.7 mm

Ordering data

Type	Order No.	Pcs./Pkt.
ELR H3-IS-SC- 24DC/500AC-3-P	2908700	1
ELR H3-IS-PT- 24DC/500AC-3-P	2909570	1
ELR H3-IS-SC- 24DC/500AC-9-P	2908698	1
ELR H3-IS-PT- 24DC/500AC-9-P	2909568	1

Accessories

EM-2RSC/21AU-R/L-P	2908701	1
EM-2RPT/21AU-R/L-P	2909573	1

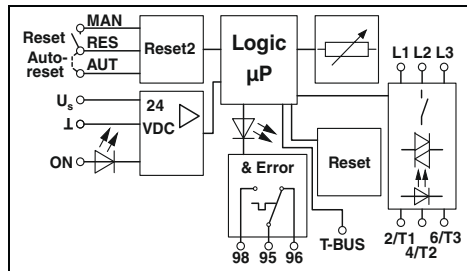

Technical data

24 V DC
19.2 V DC ... 30 V DC
60 mA
24 V DC
19.2 V DC ... 30 V DC
7 mA
Surge protection, reverse polarity protection
Green LED / Yellow LED / Red LED

42 V AC ... 550 V AC

550 V
6 kV
-25°C ... 70°C (observe derating)
EN 60947-1 / EN 60947-4-2
Vertical (horizontal DIN rail, motor output below)

Alignable, for spacing see derating
0.2 - 2.5 mm² / 0.2 - 2.5 mm² / 24 - 14
22.5 mm / 106.6 mm / 113.7 mm

Ordering data

Type	Order No.	Pcs./Pkt.
ELR H3-I-SC- 24DC/500AC-3-P	2908696	1
ELR H3-I-PT- 24DC/500AC-3-P	2909563	1
ELR H3-I-SC- 24DC/500AC-9-P	2908694	1
ELR H3-I-PT- 24DC/500AC-9-P	2909561	1

Accessories

EM-2RSC/21AU-R/L-P	2908701	1
EM-2RPT/21AU-R/L-P	2909573	1

Hybrid motor starters

Hybrid motor starters with direct start function

These 3-phase hybrid motor starters offer up to three functions: forward running, motor protection, and emergency stop up to SIL 3 / PL e.

Featuring the following advantages:

- 22.5 mm wide
- Reduced wiring effort
- Bi-metal function, adjustable up to 9 A
- Long service life
- Space-saving
- 3-phase loop bridging

Safety level in accordance with:

- IEC 61508-1: SIL 3
- ISO 13849: PL e

Notes:
Type of insulating housing: Polyamide PA non-reinforced, color: gray.
Marking systems and mounting material See Catalog 3

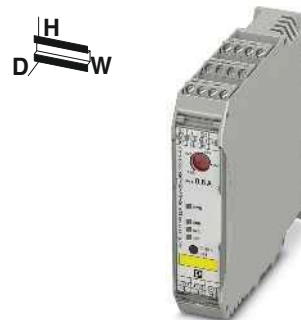

Motor protection and emergency stop

Ex:

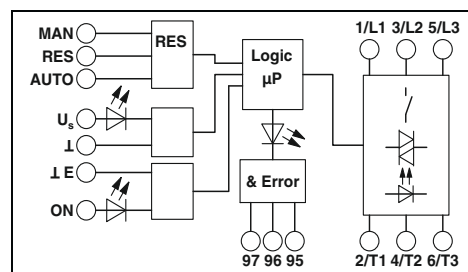

Technical data

Input data	24 V DC	230 V AC
Rated control supply voltage U_s	19.2 V DC ... 30 V DC	85 V AC ... 253 V AC
Control supply voltage range	40 mA	4 mA
Rated control supply current I_s at U_s	24 V DC	230 V AC
Rated actuation voltage U_c ON	19.2 V DC ... 30 V DC	85 V AC ... 253 V AC
Actuating voltage range	5 mA (input type 1)	7 mA (input type 1)
Rated actuating current I_c at U_c	Surge protection, reverse polarity protection	Surge protection
Input circuit	Green LED / Yellow LED / Red LED	
Output data load side	42 V AC ... 550 V AC	42 V AC ... 550 V AC
Operating voltage range	Surge protection	
Output protection		
General data		
Rated insulation voltage	500 V	
Rated surge voltage	6 kV	4 kV
Ambient temperature (operation)	-25°C ... 70°C (observe derating)	
Standards/regulations	IEC 60947-1 / IEC 60947-4-2 / IEC 61508 / ISO 13849	
Mounting position	Vertical (horizontal DIN rail, motor output below)	
Mounting	Alignable, for spacing see derating	
Connection data solid/stranded/AWG	0.2 - 2.5 mm ² / 0.2 - 2.5 mm ² / 24 - 14	
Dimensions	22.5 mm / 106.6 mm / 113.7 mm	

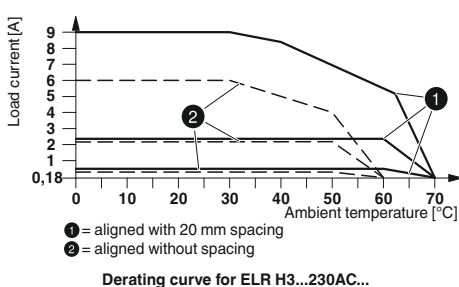
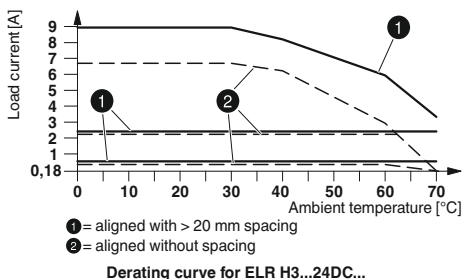

Description
Load current 0.075 A ... 0.6 A Screw connection Push-in connection
Load current 0.18 A ... 2.4 A Screw connection Push-in connection Screw connection
Load current 1.5 A ... 9 A Screw connection Push-in connection Screw connection
Load current 0 A ... 9 A Screw connection Screw connection

Ordering data

Type	Order No.	Pcs./Pkt.
ELR H3-IES-SC- 24DC/500AC-0,6	2900566	1
ELR H3-IES-PT- 24DC/500AC-0,6	2903914	1
ELR H3-IES-SC- 24DC/500AC-2	2900567	1
ELR H3-IES-PT- 24DC/500AC-2	2903916	1
ELR H3-IES-SC-230AC/500AC-2	2900568	1
ELR H3-IES-SC- 24DC/500AC-9	2900569	1
ELR H3-IES-PT- 24DC/500AC-9	2903918	1
ELR H3-IES-SC-230AC/500AC-9	2900570	1



Motor protection

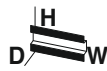

Direct start function only

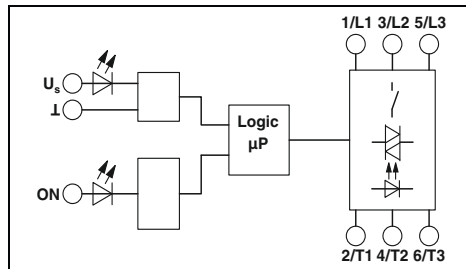
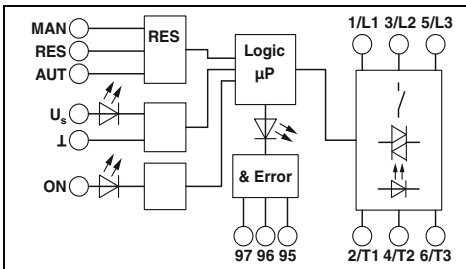

Technical data

24 V DC	230 V AC
19.2 V DC ... 30 V DC	85 V AC ... 253 V AC
40 mA	4 mA
24 V DC	230 V AC
19.2 V DC ... 30 V DC	85 V AC ... 253 V AC
5 mA (input type 1)	7 mA (input type 1)
Surge protection, reverse polarity protection	Surge protection
Green LED / Yellow LED / Red LED	

42 V AC ... 550 V AC	42 V AC ... 550 V AC
Surge protection	

500 V
6 kV 4 kV
-25°C ... 70°C (observe derating)
IEC 60947-1 / IEC 60947-4-2 / IEC 61508 / ISO 13849
Vertical (horizontal DIN rail, motor output below)

Alignable, for spacing see derating
0.2 - 2.5 mm² / 0.2 - 2.5 mm² / 24 - 14
22.5 mm / 106.6 mm / 113.7 mm

Technical data

24 V DC	230 V AC
19.2 V DC ... 30 V DC	85 V AC ... 253 V AC
40 mA	4 mA
24 V DC	230 V AC
19.2 V DC ... 30 V DC	85 V AC ... 253 V AC
5 mA (input type 1)	7 mA (input type 1)
Surge protection, reverse polarity protection	Surge protection
Green LED / Yellow LED / -	

42 V AC ... 550 V AC	42 V AC ... 550 V AC
Surge protection	

500 V
6 kV 4 kV
-25°C ... 70°C (observe derating)
IEC 60947-1 / IEC 60947-4-2 / IEC 61508 / ISO 13849
Vertical (horizontal DIN rail, motor output below)

Alignable, for spacing see derating
0.2 - 2.5 mm² / 0.2 - 2.5 mm² / 24 - 14
22.5 mm / 106.6 mm / 113.7 mm

Ordering data

Type	Order No.	Pcs./Pkt.
ELR H3-I-SC- 24DC/500AC-0,6	2900542	1
ELR H3-I-PT- 24DC/500AC-0,6	2903920	1
ELR H3-I-SC- 24DC/500AC-2	2900543	1
ELR H3-I-PT- 24DC/500AC-2	2903922	1
ELR H3-I-SC-230AC/500AC-2	2900544	1
ELR H3-I-SC- 24DC/500AC-9	2900545	1
ELR H3-I-PT- 24DC/500AC-9	2903924	1
ELR H3-I-SC-230AC/500AC-9	2900546	1

Ordering data

Type	Order No.	Pcs./Pkt.
ELR H3-SC- 24DC/500AC-9	2900530	1
ELR H3-SC-230AC/500AC-9	2900531	1

Hybrid motor starters

Hybrid motor starters with short-circuit protection



These short-circuit-proof 3-phase hybrid motor starters for mounting on 35 mm DIN rails, the CrossPowerSystem energy distribution board, or 60 mm power busbars combine four functions in one device: forward running, reverse running, motor protection, and emergency stop up to SIL 3/PL e.

- Featuring the following advantages:
- 22.5 mm wide
 - Bi-metal function, adjustable up to 9 A
 - Long service life
 - Space-saving
 - Reduced wiring effort
 - 3-phase loop bridging
 - Plug-in motor output terminal block
 - Coordination type 2 in accordance with IEC/EN 60947-4-2
 - IEC 61508-1: SIL 3
 - ISO 13849: PL e

Input data

Rated control supply voltage U_s
 Control supply voltage range
 Rated control supply current I_s at U_s
 Rated actuating voltage U_c R/L
 Actuating voltage range
 Rated actuating current I_c at U_c
 Input circuit
 Operating voltage / status / error indicator

Output data load side

Operating voltage range
 Load current range

Output protection

General data

Rated insulation voltage
 Rated surge voltage
 Ambient temperature (operation)
 Standards/regulations
 Mounting position

Mounting

Screw connection rigid / flexible / AWG

Dimensions

W / H / D

Description

Short-circuit-proof hybrid motor starters

Hybrid motor starter

DIN rail adapter

Busbar adapter, 160 mm

Busbar adapter, 200 mm

Set consisting of short-circuit-proof hybrid motor starter and adapter

- with DIN rail adapter

- with busbar adapter, 160 mm

- with busbar adapter, 200 mm

Fuse

Coordination type 2 to 10 kA/500 V

Coordination type 2 to 5 kA/400 V

Coordination type 1 to 30 kA/500 V



For reversing 3~ AC motors
up to 550 V AC/3 x 0.6 A

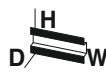

For reversing 3~ AC motors
up to 550 V AC/3 x 2.4 A



For reversing 3~ AC motors
up to 550 V AC/3 x 9 A



Ex: Ex



Ex: Ex



Ex: Ex

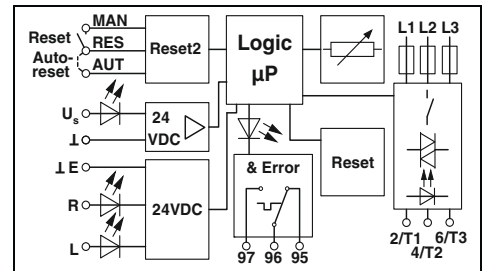
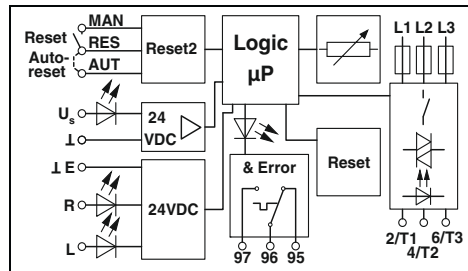
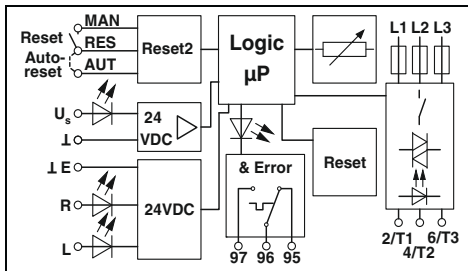

Technical data

24 V DC
19.2 V DC ... 30 V DC
40 mA
24 V DC
19.2 V DC ... 30 V DC
5 mA
Surge protection, reverse polarity protection
Green LED / Yellow LED / Red LED

42 V AC ... 550 V AC
75 mA ... 600 mA (see derating)

Surge protection, short-circuit protection

500 V
6 kV
-25°C ... 70°C (observe derating)
IEC 60947-1 / EN 60947-4-2 / IEC 61508 / ISO 13849
Vertical (horizontal DIN rail, motor output below)

Alignable, for spacing see derating
0.2 - 2.5 mm² / 0.2 - 2.5 mm² / 24 - 14
22.5 mm / 160 mm / 114.5 mm

Ordering data

Type	Order No.	Pcs./Pkt.
ELR H51-IESSC-24DC500AC-06	2902746	1
EM RD-ADAPTER	2902747	1
EM RI-ADAPTER COMPACT	2902748	1
EM RI-ADAPTER CLASSIC	2902831	1
ELR H51-0.6-DIN-RAIL-SET	2902952	1
ELR-H51-0.6-BUSBAR-COMPACT-SET	2904333	1
ELR-H51-0.6-BUSBAR-CLASSIC-SET	2904334	1

Accessories

FUSE-10X38-16A-GR	2903126	10
FUSE-10X38-20A-GR	2903384	10
FUSE-10X38-30A-MR	2903119	10

Technical data

24 V DC
19.2 V DC ... 30 V DC
40 mA
24 V DC
19.2 V DC ... 30 V DC
5 mA
Surge protection, reverse polarity protection
Green LED / Yellow LED / Red LED

42 V AC ... 550 V AC
180 mA ... 2.4 A (see derating)

Surge protection, short-circuit protection

500 V
6 kV
-25°C ... 70°C (observe derating)
IEC 60947-1 / EN 60947-4-2 / IEC 61508 / ISO 13849
Vertical (horizontal DIN rail, motor output below)

Alignable, for spacing see derating
0.2 - 2.5 mm² / 0.2 - 2.5 mm² / 24 - 14
22.5 mm / 160 mm / 114.5 mm

Ordering data

Type	Order No.	Pcs./Pkt.
ELR H51-IESSC-24DC500AC-2	2902744	1
EM RD-ADAPTER	2902747	1
EM RI-ADAPTER COMPACT	2902748	1
EM RI-ADAPTER CLASSIC	2902831	1
ELR H51-2.4-DIN-RAIL-SET	2902953	1
ELR-H51-2.4-BUSBAR-COMPACT-SET	2904335	1
ELR-H51-2.4-BUSBAR-CLASSIC-SET	2904336	1

Accessories

FUSE-10X38-16A-GR	2903126	10
FUSE-10X38-20A-GR	2903384	10
FUSE-10X38-30A-MR	2903119	10

Technical data

24 V DC
19.2 V DC ... 30 V DC
40 mA
24 V DC
19.2 V DC ... 30 V DC
5 mA
Surge protection, reverse polarity protection
Green LED / Yellow LED / Red LED

42 V AC ... 550 V AC
1.5 A ... 9 A (see derating)

Surge protection, short-circuit protection

500 V
6 kV
-25°C ... 70°C (observe derating)
IEC 60947-1 / EN 60947-4-2 / IEC 61508 / ISO 13849
Vertical (horizontal DIN rail, motor output below)

Alignable, for spacing see derating
0.2 - 2.5 mm² / 0.2 - 2.5 mm² / 24 - 14
22.5 mm / 160 mm / 114.5 mm

Ordering data

Type	Order No.	Pcs./Pkt.
ELR H51-IESSC-24DC500AC-9	2902745	1
EM RD-ADAPTER	2902747	1
EM RI-ADAPTER COMPACT	2902748	1
EM RI-ADAPTER CLASSIC	2902831	1
ELR H51-9-DIN-RAIL-SET	2902954	1
ELR-H51-9-BUSBAR-COMPACT-SET	2904337	1
ELR-H51-9-BUSBAR-CLASSIC-SET	2904338	1

Accessories

FUSE-10X38-16A-GR	2903126	10
FUSE-10X38-20A-GR	2903384	10
FUSE-10X38-30A-MR	2903119	10

Hybrid motor starters

Loop bridges for hybrid motor starters

The flexible CONTACTRON loop bridge (BRIDGE-...) simplifies the supply and looping through of phases L1, L2, and L3. It is available in 2- to 10-bridge versions for modules in the CONTACTRON family with 22.5 mm housing width.

Features of the 3-phase loop bridge:

- Significant reductions in wiring effort
- Suitable for CONTACTRON series
 - ELR H3...
 - ELR H5...
 - EMM...IFS
- Bridging of 2 to 10 devices with maximum module spacing of 22.5 mm
- Up to 575 V AC/3 x 25 A
- Additional bridge versions available on request



0.3 m connecting cable for hybrid motor starters, with screw connection

ERIC

General data	
Nominal voltage U_N	42 V AC ... 575 V AC
Nominal current at U_N	≤25 A
Cross section	2.5 mm ²

Technical data		
42 V AC ... 575 V AC		
≤25 A		
2.5 mm ²		

Description	
3-phase loop bridge	
2-bridge	
3-bridge	
4-bridge	
5-bridge	
6-bridge	
7-bridge	
8-bridge	
9-bridge	
10-bridge	

Ordering data		
Type	Order No.	Pcs./Pkt.
BRIDGE- 2	2900746	1
BRIDGE- 3	2900747	1
BRIDGE- 4	2900748	1
BRIDGE- 5	2900749	1
BRIDGE- 6	2900750	1
BRIDGE- 7	2900751	1
BRIDGE- 8	2900752	1
BRIDGE- 9	2900753	1
BRIDGE-10	2900754	1

Covering hood for unused connectors	
BRIDGE COVER	2906240

Accessories		
BRIDGE COVER	2906240	10

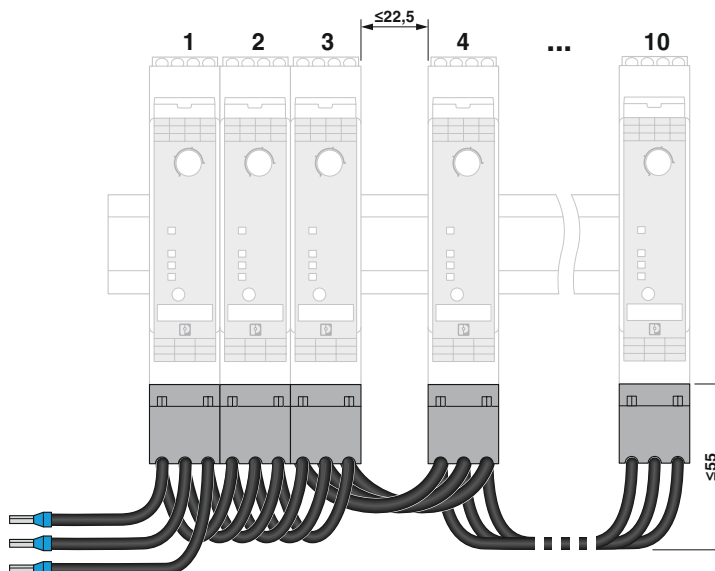



3 m connecting cable for hybrid motor starters, with screw connection



3 m connecting cable for hybrid motor starters, with Push-in connection

ERC

Technical data
42 V AC ... 575 V AC
≤25 A
2.5 mm ²

Ordering data		
Type	Order No.	Pcs./Pkt.
BRIDGE- 2-3M	2901543	1
BRIDGE- 3-3M	2901656	1
BRIDGE- 4-3M	2901659	1
BRIDGE- 5-3M	2901545	1
BRIDGE- 6-3M	2901697	1
BRIDGE- 7-3M	2901698	1
BRIDGE- 8-3M	2901700	1
BRIDGE- 9-3M	2901701	1
BRIDGE-10-3M	2901702	1

Accessories		
BRIDGE COVER	2906240	10

ERC

Technical data
42 V AC ... 575 V AC
≤25 A
2.5 mm ²

Ordering data		
Type	Order No.	Pcs./Pkt.
BRIDGE-PT 2	2904490	1
BRIDGE-PT 3	2904491	1
BRIDGE-PT 4	2904492	1
BRIDGE-PT 5	2904493	1
BRIDGE-PT 6	2904494	1
BRIDGE-PT 7	2904495	1
BRIDGE-PT 8	2904496	1
BRIDGE-PT 9	2904497	1
BRIDGE-PT 10	2904498	1

Accessories		
BRIDGE COVER	2906240	10

Solid-state contactors

Three-phase solid-state reversing contactors

The 3-phase solid-state reversing contactors with integrated locking circuit and load wiring are ideally suited for applications such as:

- Control valves
- Slides
- Switches
- Ship steering gear

The power spectrum ranges from 575 V AC/3 x 2 A to 575 V AC/3 x 37 A. This corresponds to 1 kW to 18.5 kW.

Advantages of the three-phase solid-state reversing contactors:

- Noise-free and wear-free switching
- Integrated protective circuit
- Stable and short switching times
- Long service life
- High switching frequency
- Integrated locking and load wiring
- Thermal fuse optional

Notes:

Type of insulating housing:
ELR W 3...2, ELR W 3...9
 Polyamide PA non-reinforced, color: gray
ELR W 3...37
 Polyester PBT non-reinforced, color: gray
 Marking systems and mounting material
 See Catalog 3



For reversing 3- AC motors up to 575 V AC/3 x 2 A

ERIE DNV GL

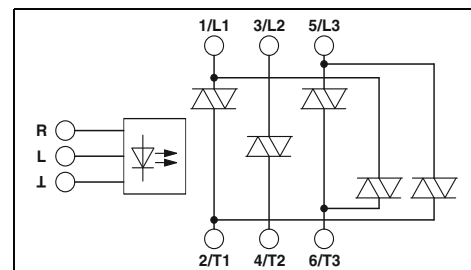

Technical data

Input data	24 V DC	230 V AC
Rated actuating voltage U_c R/L	19.2 V DC ... 30 V DC	92 V AC ... 253 V AC
Actuating voltage range	12.7 mA	11.2 mA
Rated actuating current I_c at U_c	Reverse polarity protection, surge protection	Surge protection
Input circuit	- / Yellow LED / Red LED	
Operating voltage / status / error indicator		
Output data load side	48 V AC ... 575 V AC	48 V AC ... 575 V AC
Operating voltage range	1200 V	1200 V
Periodic peak reverse voltage	100 mA ... 2 A (see derating)	100 mA ... 2 A (see derating)
Load current range		
Residual voltage	<1.5 V	<1.5 V
Leakage current	6 mA	6 mA
Max. load value $I^2 \times t$ ($t = 10$ ms)	250 A ² s	250 A ² s
Output protection	RCV circuit	
General data		
Rated insulation voltage	500 V	
Rated surge voltage	6 kV	6 kV
Insulation	Basic insulation	
Reversing frequency	≤10 Hz	≤2 Hz
Switching frequency	max. 5 Hz	max. 1 Hz
Ambient temperature (operation)	-25°C ... 70°C	
Standards/regulations	DIN EN 50178 / EN 60947	
Degree of protection in accordance with IEC 60529/EN 60529	IP20	
Mounting position	Vertical (horizontal DIN rail)	
Mounting	Can be aligned with spacing = 20 mm	
Screw connection rigid / flexible / AWG	0.2 - 2.5 mm ² / 0.2 - 2.5 mm ² / 24 - 14	
- Control side	0.2 - 2.5 mm ² / 0.2 - 2.5 mm ² / 24 - 14	
- Load side	40 mm / 99 mm / 114.5 mm	
Dimensions	W / H / D	

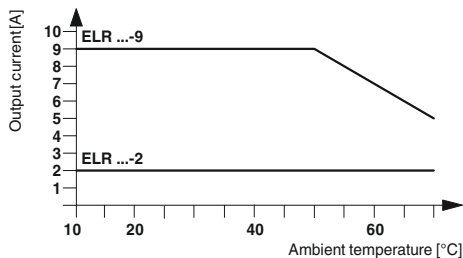

Load current as a function of the ambient temperature
 Operating time: 100% operating factor

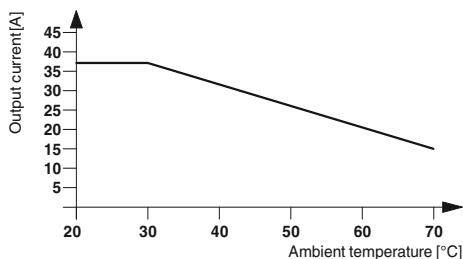

Load current as a function of the ambient temperature
 Operating time: 100% operating factor

Description
3-phase solid-state reversing contactor

Thermal fuse

Ordering data

Type	Order No.	Pcs./Pkt.
ELR W3- 24DC/500AC- 2	2297293	1
ELR W3-230AC/500AC- 2	2297303	1

Accessories

THERMAL FUSE TF104	2900796	1
--------------------	---------	---



For reversing 3~ AC motors
up to 575 V AC/3 x 9 A



For reversing 3~ AC motors
up to 575 V AC/3 x 37 A

ERIC DNV GL

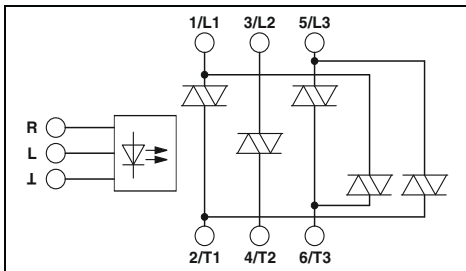

Technical data

24 V DC	230 V AC
19.2 V DC ... 30 V DC	92 V AC ... 253 V AC
12.7 mA	11.2 mA
Reverse polarity protection, surge protection	Surge protection

- /Yellow LED / Red LED

48 V AC ... 575 V AC	48 V AC ... 575 V AC
1200 V	1200 V
100 mA ... 9 A (see derating)	100 mA ... 9 A (see derating)

<1.5 V	<1.5 V
6 mA	6 mA
580 A ² s	580 A ² s

RCV circuit

500 V	6 kV
6 kV	6 kV
Basic insulation	6 kV
≤10 Hz	≤2 Hz
max. 5 Hz	max. 1 Hz
-25°C ... 70°C	

DIN EN 50178 / EN 60947

IP20

Vertical (horizontal DIN rail)

Can be aligned with spacing = 20 mm

0.2 - 2.5 mm ² / 0.2 - 2.5 mm ² / 24 - 14
0.2 - 2.5 mm ² / 0.2 - 2.5 mm ² / 24 - 14
67.5 mm / 99 mm / 114.5 mm

Ordering data

Type	Order No.	Pcs./Pkt.
ELR W3- 24DC/500AC- 9	2297316	1
ELR W3-230AC/500AC- 9	2297329	1

Accessories

THERMAL FUSE TF104	2900796	1
--------------------	---------	---

ERIC DNV GL

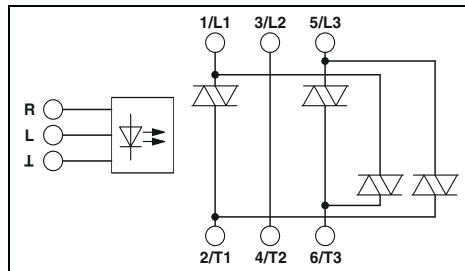

Technical data

24 V DC	230 V AC
19.2 V DC ... 30 V DC	92 V AC ... 253 V AC
12.7 mA	11.2 mA
Reverse polarity protection, surge protection	Surge protection

- /Yellow LED / Red LED

48 V AC ... 575 V AC	48 V AC ... 575 V AC
1200 V	1200 V
200 mA ... 37 A (see derating)	200 mA ... 37 A (see derating)

<1.5 V	<1.5 V
6 mA	6 mA
9,000 A ² s	9,000 A ² s

RCV circuit

500 V	6 kV
6 kV	6 kV
Basic insulation	6 kV
≤10 Hz	≤2 Hz
max. 5 Hz	max. 1 Hz
-25°C ... 70°C	

DIN EN 50178 / EN 60947

IP20

Vertical (horizontal DIN rail)

Can be aligned with spacing = 40 mm

0.2 - 4 mm ² / 0.2 - 2.5 mm ² / 24 - 12
0.5 - 16 mm ² / 0.5 - 16 mm ² / 20 - 6
147.5 mm / 99 mm / 114.5 mm

Ordering data

Type	Order No.	Pcs./Pkt.
ELR W2+1- 24DC/500AC-37	2297374	1
ELR W2+1-230AC/500AC-37	2297387	1

Accessories

THERMAL FUSE TF104	2900796	1
--------------------	---------	---

Solid-state contactors

Three-phase semiconductor contactors

The 3-phase solid-state contactors are ideally suited for applications such as:

- Mixers
- Machine tools
- Conveying systems
- Pumps
- Fans

The power spectrum ranges from 575 V AC/3 x 2 A to 575 V AC/3 x 37 A. This corresponds to 1 kW to 18.5 kW.

Advantages of three-phase semiconductor contactors:

- Noise-free and wear-free switching
- Integrated protective circuit
- Stable and short switching times
- Long service life
- High switching frequency
- Thermal fuse optional

Notes:

Type of insulating housing:
ELR W 3...2, ELR W 3...9
 Polyamide PA non-reinforced, color: gray
ELR W 3...37
 Polyester PBT non-reinforced, color: gray
 Marking systems and mounting material
 See Catalog 3



For switching 3~ AC motors up to 575 V AC/3 x 2 A

ERIE DNV GL

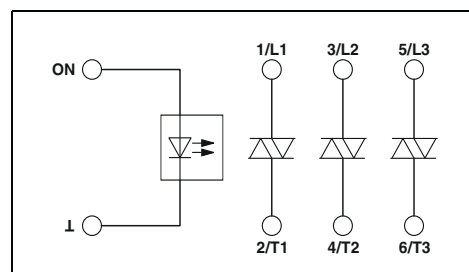

Technical data

Input data	24 V DC	230 V AC
Rated actuation voltage U_c ON	19.2 V DC ... 30 V DC	92 V AC ... 253 V AC
Actuating voltage range	8.3 mA	12.5 mA
Rated actuating current I_c at U_c	Reverse polarity protection, surge protection	Surge protection
Input circuit	- / Yellow LED / Red LED	
Operating voltage / status / error indicator		
Output data load side	48 V AC ... 575 V AC	48 V AC ... 575 V AC
Operating voltage range	1200 V	1200 V
Periodic peak reverse voltage	100 mA ... 2 A (see derating)	100 mA ... 2 A (see derating)
Load current range		
Residual voltage	<1.5 V	<1.5 V
Leakage current	6 mA	6 mA
Max. load value $I^2 \times t$ (t = 10 ms)	250 A ² s	250 A ² s
Output protection	RCV circuit	
General data		
Rated insulation voltage	500 V	
Rated surge voltage	6 kV	6 kV
Insulation	Basic insulation	
Switching frequency	≤10 Hz	≤1 Hz
Ambient temperature (operation)	-25°C ... 70°C	
Standards/regulations	DIN EN 50178 / EN 60947	
Degree of protection in accordance with IEC 60529/EN 60529	IP20	
Mounting position	Vertical (horizontal DIN rail)	
Mounting	Can be aligned with spacing = 20 mm	
Screw connection rigid / flexible / AWG		
- Control side	0.2 - 2.5 mm ² / 0.2 - 2.5 mm ² / 24 - 14	
- Load side	0.2 - 2.5 mm ² / 0.2 - 2.5 mm ² / 24 - 14	
Dimensions	40 mm / 99 mm / 114.5 mm	

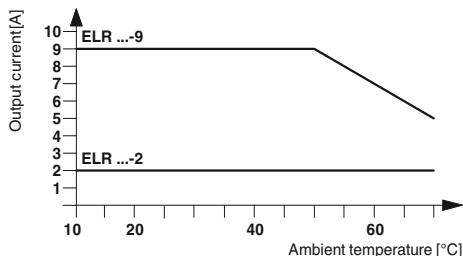

Load current as a function of the ambient temperature
 Operating time: 100% operating factor

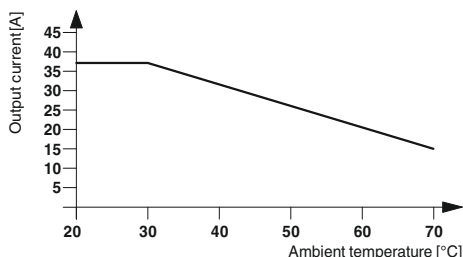

Load current as a function of the ambient temperature
 Operating time: 100% operating factor

Description

Three-phase semiconductor contactor

Thermal fuse

Ordering data

Type	Order No.	Pcs./Pkt.
ELR 3- 24DC/500AC- 2	2297196	1
ELR 3-230AC/500AC- 2	2297206	1

Accessories

THERMAL FUSE TF104	2900796	1
--------------------	---------	---



For switching 3~ AC motors
up to 575 V AC/3 x 9 A



For switching 3~ AC motors
up to 575 V AC/3 x 37 A

ERIC DNV GL

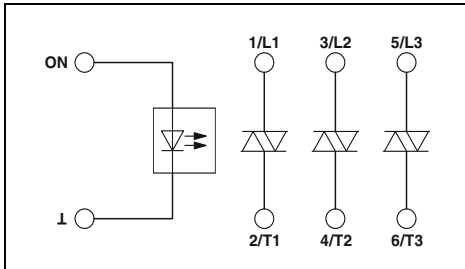

Technical data

24 V DC	230 V AC
19.2 V DC ... 30 V DC	92 V AC ... 253 V AC
8.3 mA	12.5 mA
Reverse polarity protection, surge protection	Surge protection
- /Yellow LED / Red LED	
48 V AC ... 575 V AC	48 V AC ... 575 V AC
1200 V	1200 V
100 mA ... 9 A (see derating)	100 mA ... 9 A (see derating)
<1.5 V	<1.5 V
6 mA	6 mA
580 A ² s	580 A ² s
RCV circuit	
500 V	6 kV
6 kV	6 kV
Basic insulation	6 kV
≤10 Hz	≤1 Hz
-25°C ... 70°C	
DIN EN 50178 / EN 60947	
IP20	
Vertical (horizontal DIN rail)	
Can be aligned with spacing = 20 mm	
0.2 - 2.5 mm ² / 0.2 - 2.5 mm ² / 24 - 14	
0.2 - 2.5 mm ² / 0.2 - 2.5 mm ² / 24 - 14	
67.5 mm / 99 mm / 114.5 mm	

Ordering data

Type	Order No.	Pcs./Pkt.
ELR 3- 24DC/500AC- 9	2297219	1
ELR 3-230AC/500AC- 9	2297222	1

Accessories

Accessories	Order No.	Pcs./Pkt.
THERMAL FUSE TF104	2900796	1

ERIC DNV GL

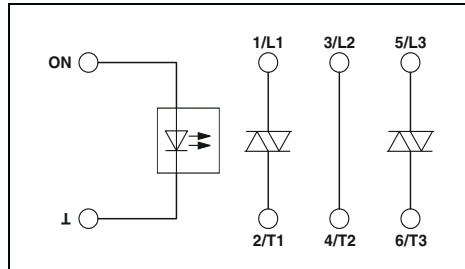

Technical data

24 V DC	230 V AC
19.2 V DC ... 30 V DC	92 V AC ... 253 V AC
8.3 mA	12.5 mA
Reverse polarity protection, surge protection	Surge protection
- /Yellow LED / Red LED	
48 V AC ... 575 V AC	48 V AC ... 575 V AC
1200 V	1200 V
200 mA ... 37 A (see derating)	200 mA ... 37 A (see derating)
<1.5 V	<1.5 V
6 mA	6 mA
9,000 A ² s	9,000 A ² s
RCV circuit	
500 V	6 kV
6 kV	6 kV
Basic insulation	6 kV
≤10 Hz	≤1 Hz
-25°C ... 70°C	
DIN EN 50178 / EN 60947	
IP20	
Vertical (horizontal DIN rail)	
Can be aligned with spacing = 40 mm	
0.2 - 4 mm ² / 0.2 - 2.5 mm ² / 24 - 12	
0.5 - 16 mm ² / 0.5 - 16 mm ² / 20 - 6	
147.5 mm / 99 mm / 114.5 mm	

Ordering data

Type	Order No.	Pcs./Pkt.
ELR 2+1- 24DC/500AC-37	2297277	1
ELR 2+1-230AC/500AC-37	2297280	1

Accessories

Accessories	Order No.	Pcs./Pkt.
THERMAL FUSE TF104	2900796	1

Solid-state contactors

Semiconductor reversing contactors with soft starter

With the ELR W 3/9-400 S soft switch, you can extend the service life of a 3-phase asynchronous motor.

- Configuration takes place via display and keyboard directly on the device
- Friction time
- Torque, start
- Start up time
- Stop time
- Torque stop
- Braking time
- Braking torque
- Drive can be controlled locally via keyboard

Notes:
Type of housing: Polycarbonate PC, color: green.
Marking systems and mounting material See Catalog 3



Solid-state reversing contactor with soft starter

ERIC

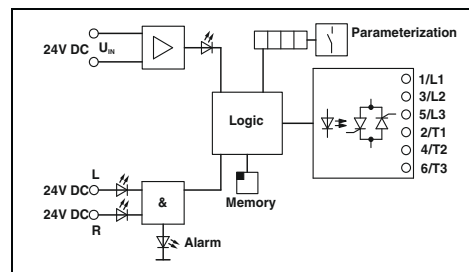

Technical data

Input data	24 V DC 0.8 ... 1.2 85 mA 24 V DC 0.8 ... 1.2 5 mA Reverse polarity protection, surge protection Green LED / Yellow LED / Red LED
Supply nominal voltage U_{VN}	24 V DC
Supply voltage range with reference to U_{VN}	0.8 ... 1.2
Quiescent current	85 mA
Control voltage U_{ST} right/left	24 V DC
Control voltage range in reference to U_{ST}	0.8 ... 1.2
Typ. input current at U_N	5 mA
Input circuit	Reverse polarity protection, surge protection Green LED / Yellow LED / Red LED
Operating voltage / status / error indicator	
Output data load side	
Max. switching voltage	440 V AC (L1/T1) 440 V AC (L2/T2) 440 V AC (L3/T3) 110 V AC ... 433 V AC 1,000 V 150 mA ... 8 A (at 20°C Tu, see derating)
Operating voltage range	
Periodic peak reverse voltage	
Load current range	
Residual voltage	Typically 1.5 V (for IL)
Leakage current	5 mA (IL1, in switched-off state)
Output protection	RC element, surge protection
General data	
Test voltage input/output	2.5 kV
Ambient temperature (operation)	-20°C ... 60°C
Standards/regulations	DIN EN 50178
Degree of protection in accordance with IEC 60529/EN 60529	IP20
Mounting position	Vertical (horizontal DIN rail)
Mounting	Can be aligned with >20 mm spacing
Screw connection rigid / flexible / AWG	0.2 - 6 mm ² / 0.2 - 4 mm ² / 24 - 10
Dimensions	62 mm / 94 mm / 122 mm
EMC note	Class A product, see page 583
	W / H / D

Description
Solid-state reversing contactor, with integrated soft switch

Ordering data

Type	Order No.	Pcs./Pkt.
ELR W3/ 9-400 S	2963569	1

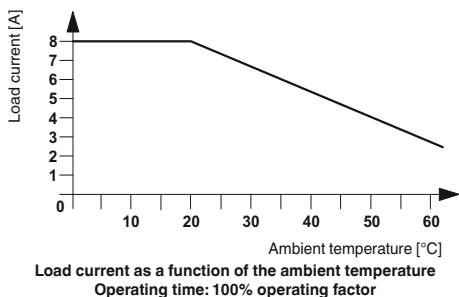

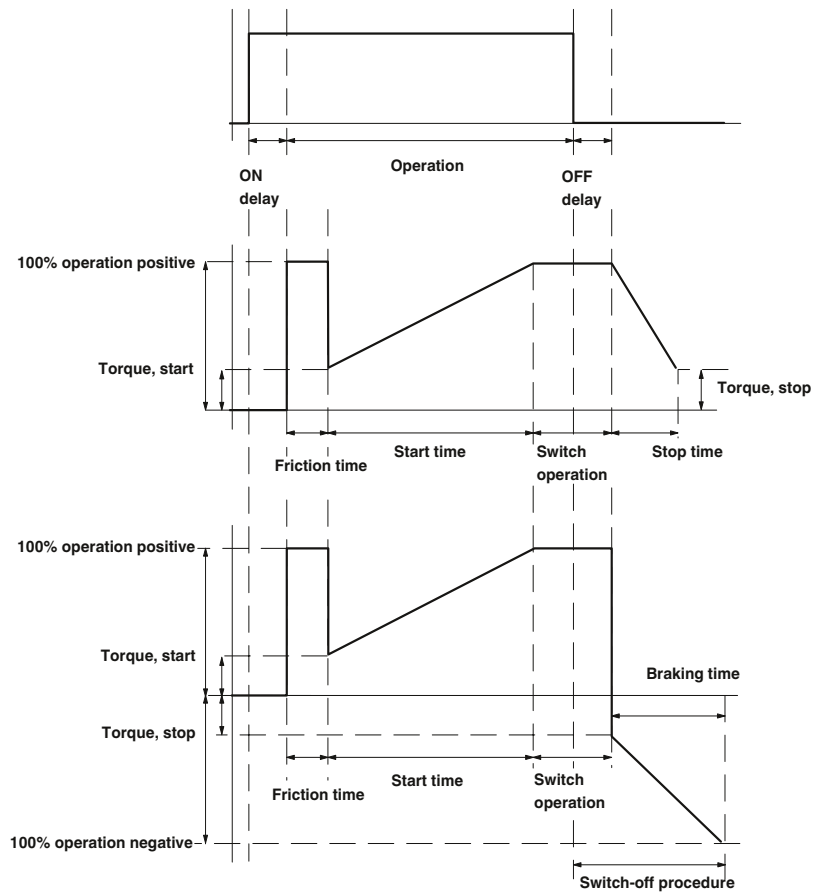

The figure shows the control of the reversing load relay with a soft starter and the operation of a three-phase current load.

Solid-state contactors

Electronic reversing load relays for DC motors

The ELR-DC electronic reversing load relays allow mechanically commutated DC motors to be switched. They reverse and reduce the speed of DC motors up to 24 V/6 A in a wear-free manner. A short-circuit, surge-voltage, and overload-proof output guarantees reliable use in the plant.

When a 24 V DC signal is applied at the “left” input, the output supplies the motor with voltage. When the “right” output is activated, the polarity of the voltage at the output is reversed. If the signal is applied at both inputs, i.e., “right” and “left”, the motor is short-circuited internally via the ELR-DC and reduces the speed.

Thanks to the internal interlocking circuit and load wiring, wiring effort is reduced to a minimum.

Notes:
Type of housing: Polycarbonate PC, color: gray.
Marking systems and mounting material See Catalog 3
PWM = Pulse Width Modulation



Electronic reversing load relay for DC motors

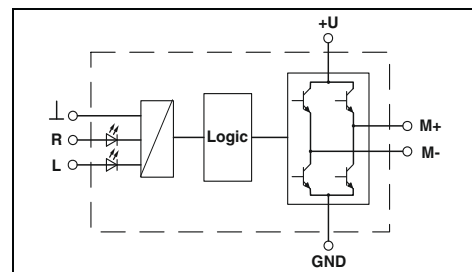

Application example

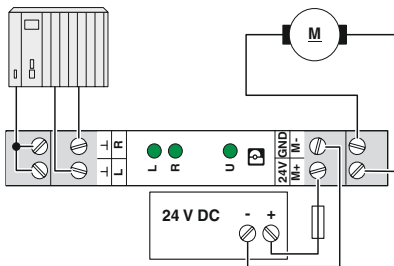

Status table			
Input		Output	
Right	Left	M +	M -
0	0	High resistance	High resistance
1	0	+24 V	GND
0	1	GND	+24 V
1	1	GND	GND

Input data	
Control voltage U_{ST} right/left	
Control voltage range in reference to U_{ST}	
Typical input current at U_N	
Input circuit	
Operating voltage / status / error indicator	
Output data load side	
Operating voltage range	
Load current	
Quiescent current	
Current limitation at short-circuits	
Output protection	
Operating voltage / status / error indicator	
General data	
Test voltage input/output	
Ambient temperature (operation)	
Nominal operating mode	
Standards/regulations	
Degree of protection in accordance with IEC 60529/EN 60529	
Mounting position	
Screw connection rigid / flexible / AWG	
Dimensions	W / H / D
EMC note	

Technical data	
24 V DC	24 V DC
0.8 ... 1.2	0.8 ... 1.2
3 mA	3 mA
Reverse polarity protection, surge protection Green LED / Yellow LED / -	
10 V DC ... 30 V DC	10 V DC ... 30 V DC
2 A (mounted in rows with zero spacing)	6 A (see derating)
Approx. 7 mA (when switched off)	Approx. 7 mA (when switched off)
15 A	20 A
Reverse polarity protection, surge protection Green LED / - / -	
2.5 kV _{rms}	
-20°C ... 60°C	
100% operating factor	
EN 50178	
IP20	
Vertical (horizontal DIN rail, motor output below)	
0.14 - 2.5 mm ² / 0.14 - 2.5 mm ² / 26 - 14	
12.5 mm / 99 mm / 114.5 mm	
Class A product, see page 583	

Load current depending on ambient temperature

Operating time: 100% (ED)

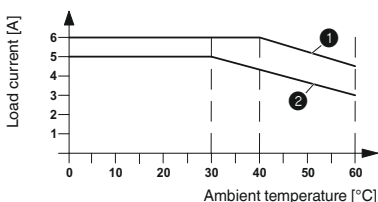

- ① Stand-alone device
- ② Aligned without spacing

Description
Electronic reversing load relay, for controlling DC motors

Ordering data		
Type	Order No.	Pcs./Pkt.
ELR W1/ 2-24DC	2963598	1
ELR W1/ 6-24DC	2982090	1



Solid-state contactors

Single-phase solid-state contactors

Single-phase solid-state contactors are used in AC voltage networks where silent switching, high switching frequencies, and practically unlimited service lives are required.

The robust power semiconductors switch to zero voltage crossing. In doing so, they do not generate any additional high-frequency interfering impulses. The modules are resistant to shock and vibration, they can even be used without problem in aggressive environments containing harmful substances.

They offer the following advantages:

- High switching frequency
- Wear-free and output-free
- Input voltage versions 24 V DC and 230 V AC

The areas of application are:

- Production machines
- Temperature controllers
- Conveyor equipment
- Lights and lighting systems

Notes:
Type of insulating housing: Polyamide PA non-reinforced, color: gray.
Marking systems and mounting material See Catalog 3



new

For switching 1~ AC motors up to 660 V AC/20 A

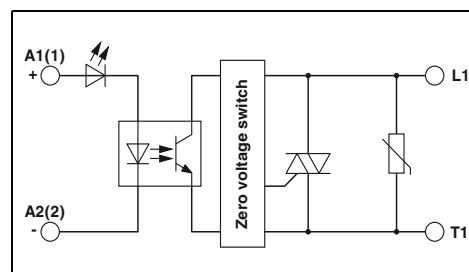

Technical data

Input data		
Actuating voltage range	4 V DC ... 32 V DC	24 V AC ... 275 V AC
Rated actuating current I_C at U_C	12 mA	17 mA
Switching level	1 signal ("H") 0 signal ("L")	≥ 4 V DC ("1" signal) ≤ 1 V DC ("0" signal)
Transmission frequency f_{limit}		≥ 20 V AC/DC ("1" signal) ≤ 5 V AC/DC ("0" signal)
Operating voltage / status / error indicator		6 Hz Green LED / - / -
Output data load side		
Operating voltage range	42 V AC ... 660 V AC	42 V AC ... 660 V AC
Periodic peak reverse voltage	1200 V	1200 V
Load current range	150 mA ... 20 A (see derating)	150 mA ... 20 A (see derating)
Residual voltage	<1.6 V	<1.6 V
Leakage current	<3 mA (in off state)	<3 mA (in off state)
Phase angle (cos ϕ)	0.5	0.5
Max. load value $I^2 \times t$ ($t = 10$ ms)	525 A ² s	525 A ² s
Output protection		Varistor
General data		
Test voltage input/output	-	-
Insulation	Basic insulation	
Ambient temperature (operation)	-30°C ... 70°C	
Standards/regulations	EN 61000-4-2 / EN 61000-4-3 / EN 61000-4-4 / EN 61000-4-5 / EN 55011	
Mounting position	Vertical (horizontal DIN rail)	
Mounting	Can be aligned with ≥ 22.5 mm spacing	
Screw connection rigid / flexible / AWG		
- Control side	0.5 - 2.5 mm ² / 0.5 - 2.5 mm ² / 18 - 12	
- Load side	2.5 - 6 mm ² / 1 - 4 mm ² / 14 - 10	
Dimensions	17.8 mm / 110 mm / 103 mm	
		W / H / D
Description		
Single-phase electronic load relay		
Ordering data		
Type	Order No.	Pcs./Pkt.
ELR 1-SC-24DC/600AC-20	1032919	1
ELR 1-SC-230AC/600AC-20	1032920	1



new



For switching 1~ AC motors
up to 660 V AC/30 A



new



For switching 1~ AC motors
up to 660 V AC/50 A

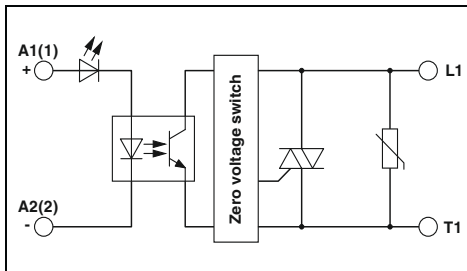

Technical data

4 V DC ... 32 V DC	24 V AC ... 275 V AC
12 mA	17 mA
≥4 V DC ("1" signal)	≥20 V AC/DC ("1" signal)
≤1 V DC ("0" signal)	≤5 V AC/DC ("0" signal)
25 Hz	6 Hz
Green LED / - / -	

42 V AC ... 660 V AC	42 V AC ... 660 V AC
1200 V	1200 V
250 mA ... 25 A (see derating)	250 mA ... 25 A (see derating)

<1.6 V	<1.6 V
<3 mA (in off state)	<3 mA (in off state)
0.5	0.5
1800 A ² s	1800 A ² s
Varistor	

-
Basic insulation
-30°C ... 70°C
EN 61000-4-2 / EN 61000-4-3 / EN 61000-4-4 / EN 61000-4-5 / EN 55011
Vertical (horizontal DIN rail)
Can be aligned with ≥22.5 mm spacing

0.5 - 2.5 mm² / 0.5 - 2.5 mm² / 18 - 12
2.5 - 6 mm² / 1 - 4 mm² / 14 - 10
17.8 mm / 110 mm / 103 mm

Ordering data

Type	Order No.	Pcs./Pkt.
ELR 1-SC-24DC/600AC-30	1032921	1
ELR 1-SC-230AC/600AC-30	1032922	1

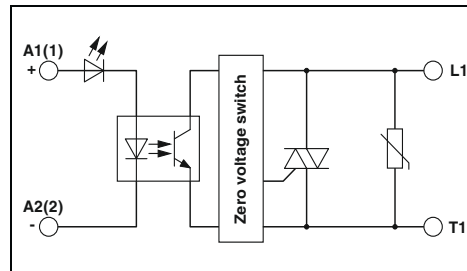

Technical data

4 V DC ... 32 V DC	24 V AC ... 275 V AC
12 mA	17 mA
≥4 V DC ("1" signal)	≥20 V AC/DC ("1" signal)
≤1 V DC ("0" signal)	≤5 V AC/DC ("0" signal)
25 Hz	6 Hz
Green LED / - / -	

42 V AC ... 660 V AC	42 V AC ... 660 V AC
1200 V	1200 V
500 mA ... 43 A (see derating)	500 mA ... 43 A (see derating)

<1.6 V	<1.6 V
<3 mA (in off state)	<3 mA (in off state)
0.5	0.5
18,000 A ² s	18,000 A ² s
Varistor	

-
Basic insulation
-30°C ... 70°C
EN 61000-4-2 / EN 61000-4-3 / EN 61000-4-4 / EN 61000-4-5 / EN 55011
Vertical (horizontal DIN rail)
Can be aligned with ≥22.5 mm spacing

0.5 - 2.5 mm² / 0.5 - 2.5 mm² / 18 - 12
2.5 - 6 mm² / 1 - 4 mm² / 14 - 10
35 mm / 110 mm / 141 mm

Ordering data

Type	Order No.	Pcs./Pkt.
ELR 1-SC-24DC/600AC-50	1032926	1
ELR 1-SC-230AC/600AC-50	1032927	1



The 3-phase CrossPowerSystem power distribution board is the new platform for modular and functional control cabinets. With just one click, the devices are mounted on the board without tools and a safe electrical connection to the three phases is established simultaneously – all in just one step.

The new CrossPowerSystem power distribution board now enables you to start up and monitor your motors more easily in your control cabinet. The CrossPowerSystem enables you to realize modular and functional solutions. Wherever necessary, simple modifications can be made or extensions can be added to adapt to new requirements.

The new 5 A power supply further reduces your wiring costs. It can be used to supply power to all hybrid motor starters on the board. Furthermore, to generate motor-relevant data for system monitoring, you can simply use the network-capable solution alongside the classic motor starter via IO-Link.



The TRIO POWER power supply features standard functionality, high quality, and reliability. It can be mounted directly on the power distribution board.



Short-circuit-proof hybrid motor starters with integrated fuses can be mounted directly on the power distribution board.



Device adapter with fuse holder for 16 A fuse (10x38/Class CC), CrossLink® interface and fixed DIN rail for IO-Link motor starters and direct starters.



Adapters for contactors and contactor combinations for loads with currents up to 45 A.

Power distribution boards

Power distribution boards

Modular power distribution boards with CrossLink® interface, 125 A, 3-pos., protected against contact and polarity reversal, width: 225 mm and 405 mm.



new



new

Power distribution board, 225 mm

Power distribution board, 405 mm

Description	Color	Ordering data			Ordering data		
		Type	Order No.	Pcs./Pkt.	Type	Order No.	Pcs./Pkt.
Power distribution boards with CrossLink® interface		EM-CPS-225	1002634	1	EM-CPS-405	1002635	1

Connection modules

3-pos. connection modules for maximum 63 A or 125 A.



new



new

63 A connection module

125 A connection module

Description	Color	Ordering data			Ordering data		
		Type	Order No.	Pcs./Pkt.	Type	Order No.	Pcs./Pkt.
Connection module with integrated spring-loaded terminals for cables from 1.5 to 16 mm ² , 3-pos., maximum 63 A		EM-CPS-TB3/63A	1002633	4			
Box terminal connection module for cables from 6 to 50 mm ² , maximum 125 A					EM-CPS-TB3/125A	1070299	4

Device adapters

new

new

Device adapter with CrossLink® interface for hybrid motor starters and miniature circuit breakers.



Device adapter



Adapter for miniature circuit breakers

Description	Color	Ordering data			Ordering data		
		Type	Order No.	Pcs./Pkt.	Type	Order No.	Pcs./Pkt.
Device adapter with fuse holder for 16 A fuse (10x38/Class CC), CrossLink® interface and fixed DIN rail		EM-CPS-DA-22,5F/16A	1002668	1			
Single-position adapters with CrossLink® interface for connecting miniature circuit breakers					EM-CPS-DA-18S/16A-L1	1089439	6
					EM-CPS-DA-18S/16A-L2	1089440	6
					EM-CPS-DA-18S/16A-L3	1089441	6
					EM-CPS-DA-18S/63A-L1	1089356	6
					EM-CPS-DA-18S/63A-L2	1089442	6
					EM-CPS-DA-18S/63A-L3	1089446	6

Device adapters

new

new

Device adapters with CrossLink® interface for contactors.



Standard device adapter



Comfort device adapter

Description	Color	Ordering data			Ordering data		
		Type	Order No.	Pcs./Pkt.	Type	Order No.	Pcs./Pkt.
Standard device adapter with CrossLink® interface and fixed DIN rail		EM-CPS-DA-45S/16A	1003291	4			
Rated current: 16 A		EM-CPS-DA-45S/32A	1003292	4			
Rated current: 32 A							
Comfort device adapter with CrossLink® interface and moveable DIN rail					EM-CPS-DA-45C/16A	1002666	4
Rated current: 16 A					EM-CPS-DA-45C/25A	1002665	4
Rated current: 25 A					EM-CPS-DA-45C/32A	1002664	4
Rated current: 32 A					EM-CPS-DA-45C/45A	1003289	4
Rated current: 45 A							
Comfort DIN rail , additional DIN rail for Comfort device adapter					EM-CPS-TS-45	1003295	1

Power distribution boards

Accessories – Device adapters

Accessories for height and side extensions for 45 mm device adapter and contactor holder.



Extension

new



Device holder

new

Description	Color	Ordering data			Ordering data		
		Type	Order No.	Pcs./Pkt.	Type	Order No.	Pcs./Pkt.
Height extension for Comfort device adapter, width: 45 mm		EM-CPS-DAE-45	1003293	8			
Lateral extension of the height extension for Comfort device adapter, width: 45 mm		EM-CPS-DAES-45	1003294	1			
Siemens device mount , positioning element for Siemens S0 and S00 switching devices					EM-CPS-DHS-45	1003296	1
Eaton device mount , positioning element for Eaton PKZ switching devices					EM-CPS-DHE-45	1002663	1

Power supplies

The new TRIO CROSS POWER power supply for the CrossPowerSystem power distribution board is perfectly adapted for use in machine building. All functions and the space-saving design are tailored to the stringent demands in this area. The Push-in connection enables quick and easy connection of a 24 V DC control voltage.

Additional features:

- Rapid startup: tool-free mounting and automatic contacting in one easy step
- Push-in connection enables quick and easy 24 V DC control voltage connection
- Reliable starting of high loads with dynamic boost



new

**Power supply,
3 AC, 24 V DC, 5 A**

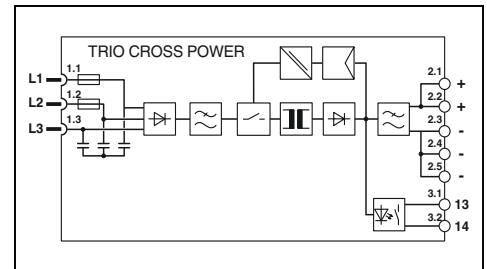

Technical data

Input data	
Nominal input voltage range	3x 400 V AC ... 500 V AC 2x 400 V AC ... 500 V AC
Input voltage range	3x 400 V AC ... 500 V AC -20% ... +15% 2x 400 V AC ... 500 V AC -10% ... +15%
Frequency range	50 Hz ... 60 Hz
Current consumption (nominal load)	3x 0.4 A (400 V AC) / 3x 0.3 A (500 V AC) 2x 0.6 A (400 V AC) / 2x 0.5 A (500 V AC)
Inrush current limitation at 25°C / I _{in}	≤22 A / ≤0.25 A ² s
Mains buffering (I _N)	Typically 20 ms (400 V AC) / typically 20 ms (500 V AC)
Output data	
Nominal output voltage	24 V DC ±1%
Setting range of the output voltage (U _{Set})	24 V DC ... 28 V DC (>24 V DC, constant capacity restricted)
Output current / dynamic boost	5 A / 7.5 A (5 s)
Can be connected in parallel/series	Yes, with redundancy module / Yes
Max. power dissipation (no load/nominal load)	<1 W (400 V AC) / <12 W (480 V AC)
Efficiency	Typically 91% (400 V AC)
Residual ripple	≤20 mV _{pp}
Signaling	
Signaling DC OK	LED, floating signal contact
General data	
Weight / dimensions W x H x D	0.7 kg / 36 x 160 x 159 mm
Connection	Cross Power System
Connection method	Snap-on connection
Input connection data (solid/stranded/AWG)	- mm ² / - mm ² / -
Output connection data (solid/stranded/AWG)	0.2 - 4 mm ² / 0.2 - 2.5 mm ² / 24 - 12
Degree of protection / protection class	IP20 / II
MTBF (IEC 61709, SN 29500)	>1,300,000 h (40°C)
Ambient temperature (operation)	-25°C ... 70°C (>60°C derating: 2.5%/K)
Standards/regulations	
Insulation voltage input/output	1.5 kV AC (routine test) / 3 kV AC (type test)
Electromagnetic compatibility	Conformance with EMC Directive 2014/30/EU
Electrical safety	IEC 61010-1 (SELV)
Electronic equipment for electrical power installations	EN 50178/VDE 0160 (PELV)
Safe isolation	DIN VDE 0100-410
UL approvals	UL Listed UL 61010-2-201
Limitation of harmonic line currents	EN 61000-3-2

Ordering data

Description	Type	Order No.	Pcs./Pkt.
Power supply unit, primary-switched	EM-CPS-PS/3AC/24DC/5	1064922	1



Measurement and control technology

From highly-compact 6 mm signal conditioners and functionally safe signal conditioners to signal isolators for intrinsically safe circuits in the Ex area: our signal conditioner range and process indicators offer a solution for all applications in analog signal conditioning.

Signal conditioners – Your advantages

- Achieve space savings of up to 65% compared to other isolators on the market with these highly compact signal conditioners
- Integrate field signals into industrial networks while also benefiting from safe electrical isolation with signal conditioners with a bus and network connection
- Precise transmission and high operational safety with signal conditioners with consistent SIL certification
- Maximum explosion protection for all Ex zones and gas groups: with single- and two-channel signal isolators for intrinsically safe circuits in the Ex area
- Integrate analog signals easily into the safety chain in accordance with the Machinery Directive: with signal conditioners with Performance Level

Process indicators and field devices – Your advantages

- Display, monitor, and control analog and temperature signals with the multifunctional process displays
- Interference-free transmission of analog signals as well as temperature measurement in the field, thanks to versatile signal conditioners and 2-conductor field devices

Product range overview

Product overview	58
Selection guide for signal conditioners	62
Basics	64
MINI Analog Pro – Highly compact signal conditioners with plug-in connection technology	66
MACX Analog – Signal conditioners with functional safety and explosion protection	112
Multiplexers for HART signals	172
Field Analog – Process indicators and field devices	180

Highly compact signal conditioners with plug-in connection technology



MINI Analog Pro

Page 66



MINI Analog Pro gateways

Page 98



System cabling, Termination Carriers

Page 102



Accessories for MINI Analog Pro

Page 106

Multiplexers



Multiplexers for HART signals

Page 172



Accessories for MACX Analog

Page 175



System cabling, Termination Carriers

Page 170

Process indicators and field devices



Field Analog

Page 180

**Signal conditioners
with functional safety**



MACX Analog

Page 116

Ex i signal conditioners with functional safety



MACX Analog

Page 142



Highly compact signal conditioners

Analog IN / Analog OUT		Page
4-way signal conditioners	Universal	68
4-way signal duplicators	Universal	70
4-way supply doublers		78
3-way signal conditioners	Universal	74
	Configurable	72
	Fixed signal combinations	76
3-way repeater power supplies	Single-channel	77
2-way repeater power supplies	Output loop-powered, 1- or 2-channel	79
2-way passive isolators	Input loop-powered, 1- or 2-channel	80
	Output loop-powered, 1- or 2-channel	81
Temperature		
Temperature transducers	For resistance thermometers	82
	For thermocouples	84
Frequency		
Frequency transducers	Universal	86
Analog frequency transducers	Universal	88
Potentiometer/resistor		
Potentiometer measuring transducers	Universal	90
Digital IN		
Signal conditioners	NAMUR sensors, floating contacts	92
Limit values		
Limit value switches	Analog limit values, universal	94
	Temperature, universal	From 96
Bus and network connection		
Gateways	Modbus RTU, PROFIBUS DP	100
	Modbus/TCP	101
Accessories		
Constant voltage/constant current sources		106
Configuration	Programming adapters	111
System cabling	System adapters	104
	Termination Carrier	105
	1:1 feed-through terminal block	110
Supply components	Power terminal, fault signaling modules, DIN rail connector, system power supply	From 108
Marking material		111
Connector sets		107
Shield fast connection		173
Test plugs		177
Resistance circuits	For line fault detection	177



Process indicators
and field devices



Ex i process indicators
and field devices

Process indicators	Page	Page
Multifunctional process indicators	182	182
Loop-powered process indicators	184	184
Standard signals	186	
Frequency	187	
Setpoint adjusters	188	
Accessories for process indicators	192	192
Temperature transducers		
Temperature head transducers	189	189
Temperature transducers, DIN rail	190	190
Accessories	193	193



**Signal conditioners
with functional safety**

Analog IN / Analog OUT		Page
3-way signal conditioners	Configurable	116
	1-channel	120
3-way repeater power supplies	Signal duplicators	From 121
	2-channel	123
2-way passive isolators	Input loop-powered, 1- or 2-channel	124
	Output loop-powered, 1- or 2-channel	125
Temperature		
Temperature transducers	For resistance temperature detectors	From 128
	For thermocouples	132
	Universal	126
Potentiometer / resistor		
Potentiometer measuring transducers	Universal	
Digital IN		
Signal conditioners	NAMUR sensors, floating contacts	134
	Signal duplicators	135 138
	NAMUR output, floating contacts	136 139
	NAMUR sensors on NAM	
Digital OUT		
Solenoid drivers	Loop-powered	
	With line fault detection	
Limit values		
Limit value switches	Analog limit values, configurable	140
	Temperature, universal	



**Ex i signal conditioners
with functional safety**

	Page
	142
	143
	144
	146
	148
	150
	150
	154
	158
	155
	158
	156
	159
	160
	166
	163
	168
	152

Glossary/the most important terms related to signal conditioners

Input

Maximum input signal:

Describes the value achieved before any damage occurs to the module.

Input resistance:

A minor input signal load can be achieved with low impedance for current inputs and high impedance for voltage inputs.

Common mode rejection:

Characterizes the suppression of identical signals at the two inputs.

Analog output**Maximum output signal:**

During uninterrupted operation, an overload at the input cannot cause greater values than at the output.

Zero/span adjustment:

Zero adjustment = setting the zero point
Span adjustment = adjustment of the analog output compared to the input, increasing/reducing the amplification factor of the output characteristic curve.

Load:

Load capacity at the output; total resistance that can be “driven”.

Residual ripple/ripple:

A superimposed ripple can appear on the output signal due to signal conditioning required by the circuit.

Open-circuit behavior:

If values exceed or fall below a tolerance limit, a defined output signal is sent.

Digital output

In the case of signal conditioners, digital outputs can be realized either using relays or transistor outputs. The switching behavior of the digital outputs can be configured.

Active isolation:

With active isolation, the module has its own power supply. A differentiation is made between three methods of active isolation:

- 3-way isolation
- Input isolation
- Repeater power supply

Passive isolation:

The modules draw the power needed for signal transmission and electrical isolation from an active input or output circuit. A differentiation is therefore made between

- Input loop-powered
- Output loop-powered

Resistance temperature detector

Resistance temperature detectors (e.g., Pt 100, Ni 1000, etc.) change their resistance value depending on the temperature. They require a constant measurement current. Signal conditioners detect this value and convert it into a proportional analog signal. With regard to the connection technology, a differentiation is made between:

- 2-conductor
- 3-conductor
- 4-conductor

Thermocouples

As opposed to resistance temperature detectors, thermocouples are active sources. They are composed of different metals and generate a voltage that – due to the Seebeck effect – is dependent on the ambient temperature.

Refer to the user manual for detailed information on the principles of MCR technology. It includes explanations on technical and physical fundamentals, application cases, and circuits. Moreover, the user manual provides information on the basic elements of functional safety, digital fieldbus systems, and an introduction into surge protection in MCR technology.

The user manual is available for download free of charge:

https://www.phoenixcontact.com/assets/downloads_ed/global/web_dwl_promotion/52007057_EN_MCR_technology_User_manual.pdf

Order No.: 105238

Non-intrinsically-safe signal transmission in potentially explosive areas

Electrical equipment operated in systems with potentially explosive areas is subject to different requirements, depending on the application. Signal conditioners and measuring transducers are generally deployed in the safe area (non-potentially explosive area). In a housing with degree of protection IP54 that is suitable for zone 2, it is also possible to install the signal conditioners and measuring transducers in a zone 2 Ex area. If enclosed in a pressure-tight encapsulated housing with type of protection Ex d, they can also be used in Ex zone 1. The respective stipulations of the corresponding type of protection and the Ex zone must be taken into consideration at all times.

The figure shows a range of options for installing electrical devices in areas with a danger of gas explosions.

Example: A sensor/actuator with type of protection “n” can be connected to an isolator from the MINI Analog Pro or MACX Analog families in zone 2.



Ex n

Ex n stands for type of protection n. In this case, it pertains to “non-sparking equipment”, that at no time represents a source of ignition due to hot surfaces or electrically or mechanically generated sparks.

See our free brochure for detailed information on the topic of explosion protection:

https://www.phoenixcontact.com/assets/downloads_ed/global/web_dwl_promotion/5149416_EN_HQ_Explosion_protection_LoRes.pdf

Order No.: 5149416

Installation of electrical devices for signal transmission

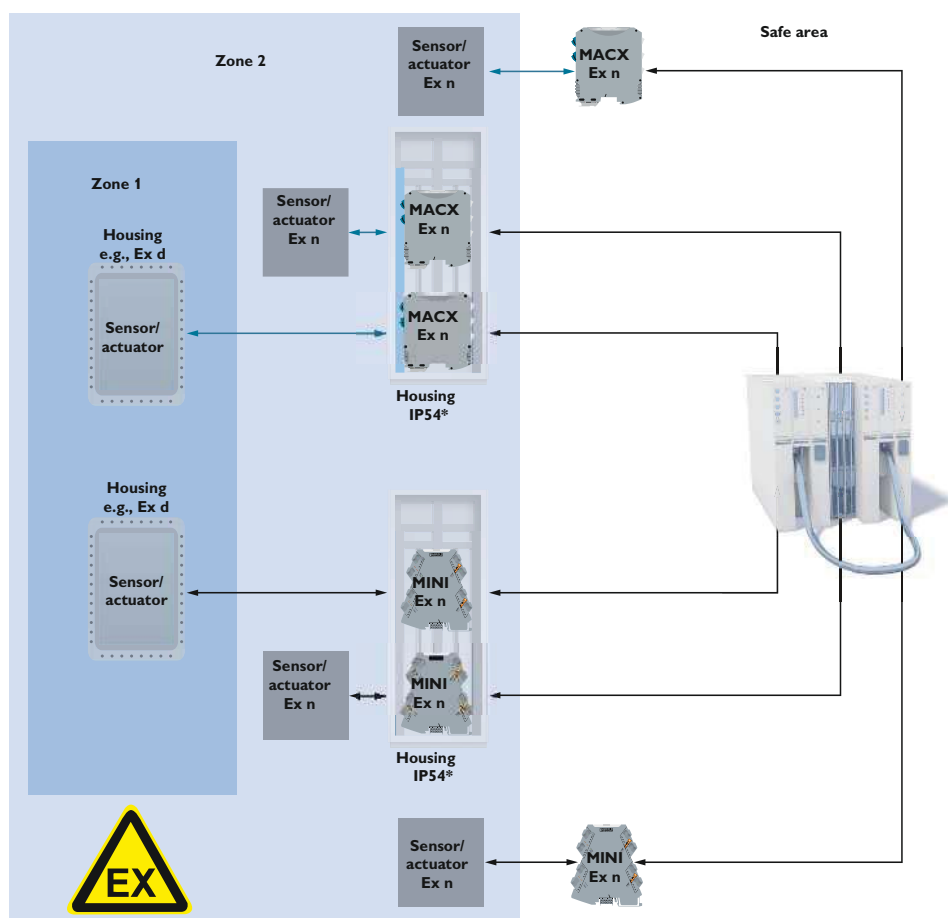

*Use of suitable housings approved for use in zone 2

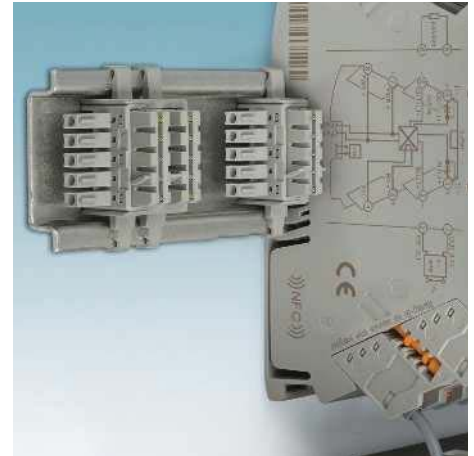
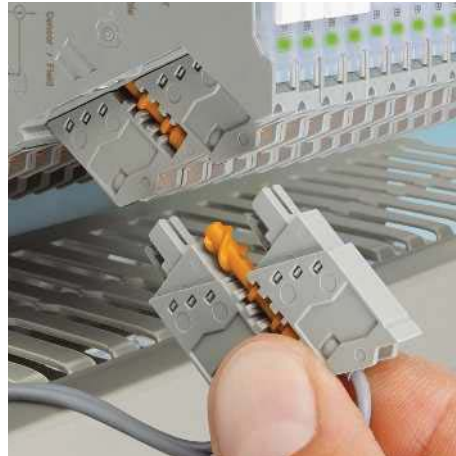
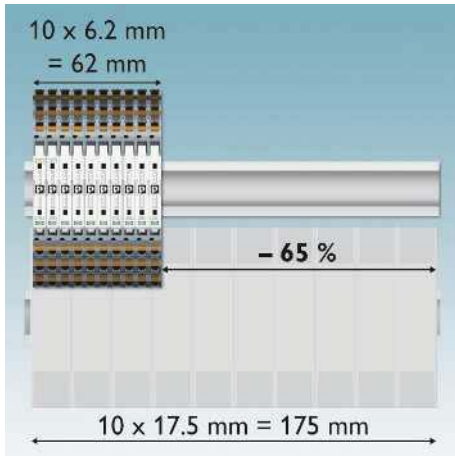
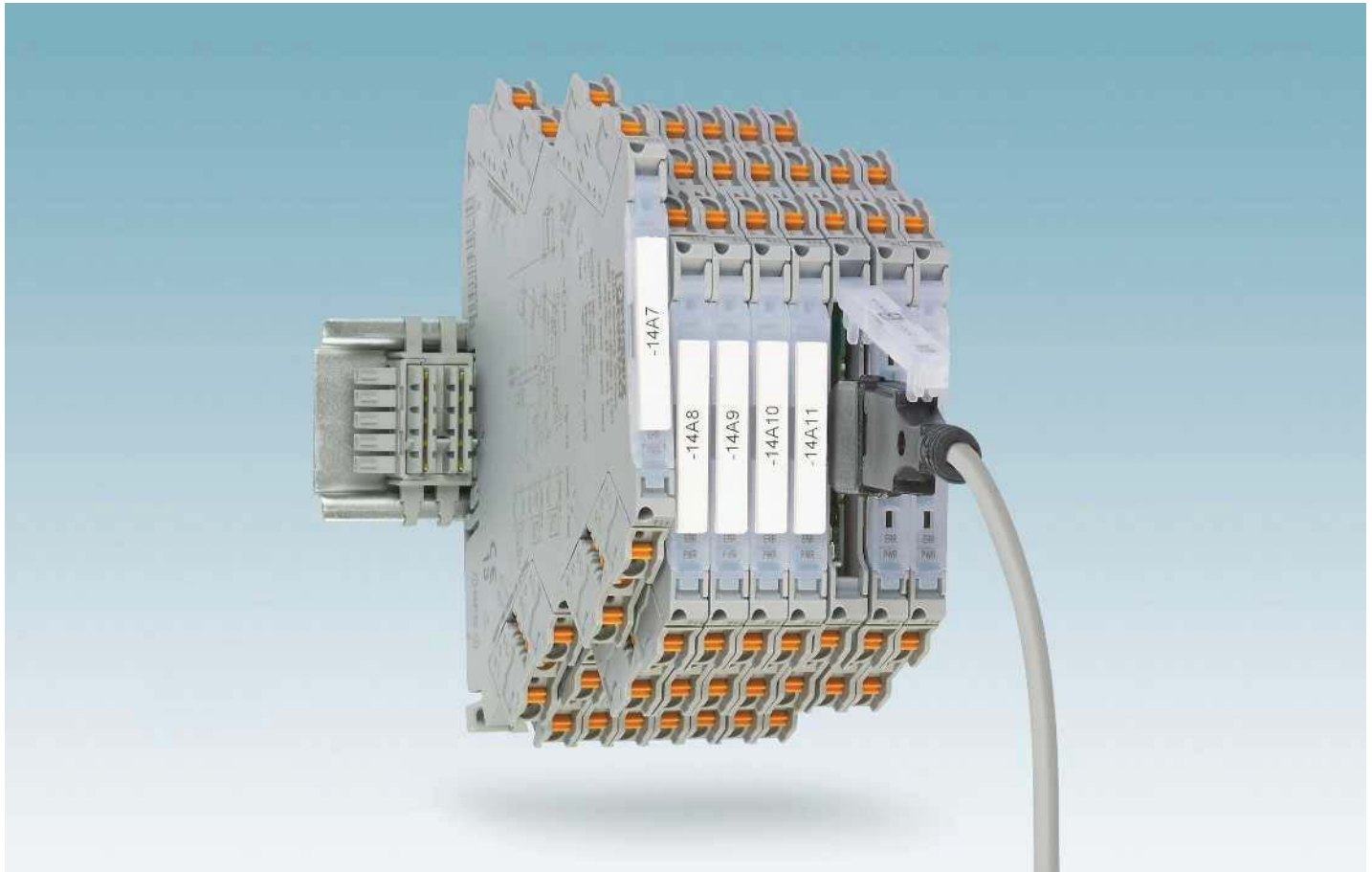

Easier than ever but as slim as before

- MINI Analog Pro offers you the easiest installation and startup in confined spaces.
- Space savings of up to 65%

Select from the following categories

- Analog IN/OUT
- Temperature
- Frequency
- Potentiometers
- Digital IN
- Limit values
- Accessories

Easy installation

- Easily visible and accessible terminal points and FASTCON Pro pluggable connection terminal blocks

Power bridging and fault monitoring

- The DIN rail connector simplifies supply and enables remote diagnostics by means of group error monitoring



DIN-rail-connector-compatible
The DIN rail connector enables modular bridging of the 24 V supply voltage.

MINI Analog Pro – Highly compact signal conditioners with plug-in connection technology

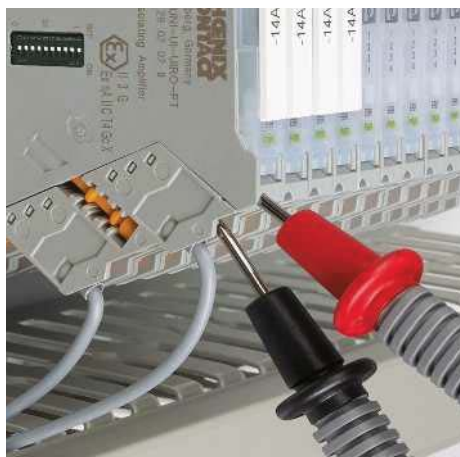

Measure current signals during operation

Measure signals conveniently for startup and servicing during operation, thanks to integrated measurement diodes.

- It is not necessary to break the circuit to integrate the measuring device into the signal circuit
- By setting the connector to the disconnect position, signal circuits can be easily interrupted during servicing and startup



Numerous configuration options

– Via DIP, PC or smartphone app

App functions via NFC communication



Access to information
– Access module information



DIP switch setting help
– Access module information
– Display DIP switch setting help on your smartphone



Configuration via smartphone
– Via Bluetooth or NFC
– Access module information
– Display DIP switch setting help
– Wireless configuration via smartphone



Service-friendly

– Generous marking areas for complete loop identification using standard marking materials as well as permanently visible status LEDs on each module

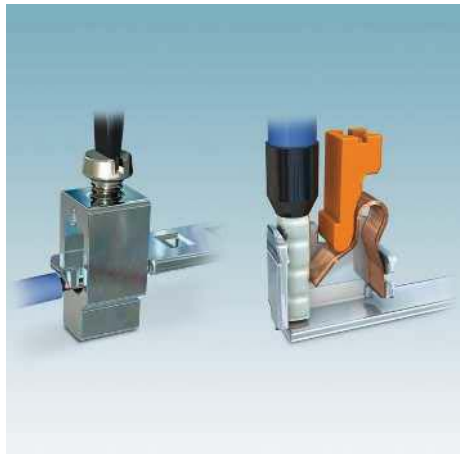

Choice of connection technology

– Wiring with screw connection or fast and tool-free with Push-in connection technology



Optimum signal quality

– The latest transmission technology and safe electrical isolation between input, output, and power supply with 3 kV test voltage

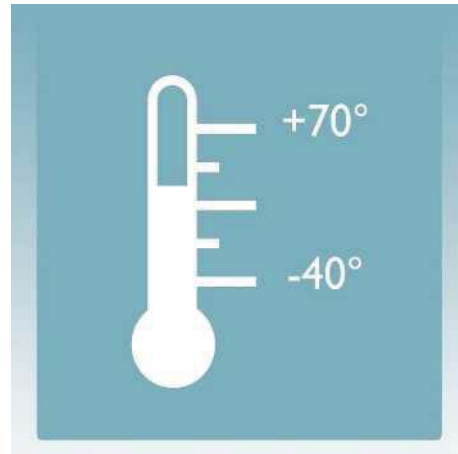

Suitable for any application

– Extended supply voltage and temperature range as well as multifunctional device types

The following parameters are generally valid for all MINI Analog Pro modules:

Test voltage input/output/power supply	3 kV (50 Hz, 1 min.)
Ambient temperature (operation)	-40°C ... 70°C
Dimensions (W / H / D)	6.2 / 110.5 / 120.5 mm
Push-in connection rigid / flexible / AWG	0.14 ... 2.5 mm ² / 0.14 ... 2.5 mm ² / 24 - 12
Screw connection rigid / flexible / AWG	0.2 ... 1.5 mm ² / 0.2 ... 1.5 mm ² / 24 - 12
Housing material	PBT
Mounting	Any

Analog IN/Analog OUT
4-way signal conditioners

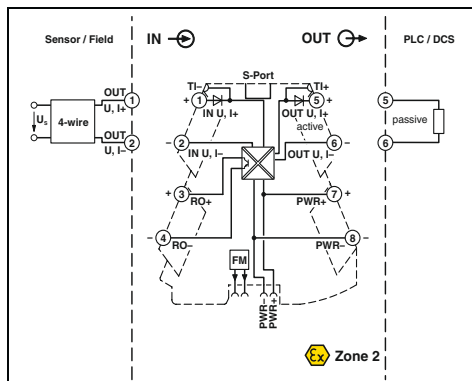
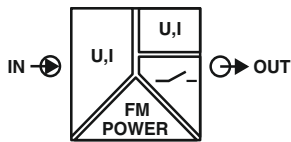

Universal 4-way signal conditioner with switching output, configurable



Housing width 6.2 mm

- Universally configurable, highly-compact signal conditioner with switching output for electrical isolation, conversion, amplification, and filtering of standard analog signals
- Plug-in connection system
- Safe 4-way isolation
- Standard signal combinations configurable via DIP switches
- Freely-configurable with software or smartphone app
- Power supply and fault monitoring possible via DIN rail connector
- Limiting behavior at the output configurable
- Status and error indicator LEDs

Notes:
The configuration software can be downloaded from the Internet: phoenixcontact.net/products .
Information on the programming adapters can be found on page 111
Information on MINI Analog Pro accessories can be found from page 107
To order a product with an order configuration, please enter the desired configuration by referring to the order key.

Input data
Input signal (configurable via DIP switch or freely via software)

Input resistance

Output data
Output signal (configurable via DIP switch or freely via software)

Maximum output signal
Load R_B
Ripple

Switching output
Relay output
Max. switching voltage
Maximum switching current

General data
Supply voltage range
Nominal supply voltage
Current consumption
Power consumption

Maximum transmission error
Temperature coefficient
Step response (10-90%)

Electrical isolation
Conformance/approvals
Conformance
ATEX
UL, USA/Canada

DNV GL

Technical data

U input	I input
0 V ... 10 V	0 mA ... 20 mA
2 V ... 10 V	4 mA ... 20 mA
0 V ... 5 V	0 mA ... 10 mA
1 V ... 5 V	2 mA ... 10 mA
10 V ... 0 V	20 mA ... 0 mA
10 V ... 2 V	20 mA ... 4 mA
5 V ... 0 V	10 mA ... 0 mA
5 V ... 1 V	10 mA ... 2 mA
0 V ... 12 V	0 mA ... 24 mA
>120 k Ω	Approx. 50 Ω (+ 0.7 V for test diode)

U output	I output
0 V ... 10 V	0 mA ... 20 mA
2 V ... 10 V	4 mA ... 20 mA
0 V ... 5 V	0 mA ... 10 mA
1 V ... 5 V	2 mA ... 10 mA
0 V ... 10.5 V	0 mA ... 21 mA
Approx. 12.3 V	24.6 mA
≥ 10 k Ω	≤ 600 Ω (at 20 mA)
<20 mV _{PP} (at 600 Ω)	<20 mV _{PP} (at 600 Ω)

1 N/O contact	I output
30 V DC	
100 mA (at 30 V)	
U output	
9.6 V DC ... 30 V DC	
24 V DC	
32 mA (24 V DC)	63 mA (12 V DC)
	≤ 1 W (at $I_{OUT} = 20$ mA, 9.6 V DC, 600 Ω load)

0.1% (of final value)
0.01%/K, typically 0.01%/K
Approx. 140 ms (15 Hz sample rate)
Approx. 45 ms (60 Hz sample rate)
Approx. 25 ms (240 Hz sample rate)
Reinforced insulation in accordance with IEC 61010-1

CE-compliant
Ex II 3 G Ex nA IIC T4 Gc X
UL 508 Listed
Class I, Div. 2, Groups A, B, C, D T6
Class I, Zone 2, Group IIC T6
B, B, A, A

Ordering data

Type	Order No.	Pcs./Pkt.
MINI MCR-2-UNI-UI-UIRO-PT	2902028	1
MINI MCR-2-UNI-UI-UIRO	2902026	1
MINI MCR-2-UNI-UI-UIRO-PT-C	2902027	1
MINI MCR-2-UNI-UI-UIRO-C	2902024	1

Accessories

IFS-USB-PROG-ADAPTER	2811271	1
TWN4 MIFARE NFC USB ADAPTER	2909681	1
IFS-BT-PROG-ADAPTER	2905872	1

Description	
4-way signal conditioner with switching output, for electrical isolation of analog signals	
Standard configuration	Push-in connection
Standard configuration	Screw connection
Order configuration	Push-in connection
Order configuration	Screw connection

Programming adapter for configuring modules with S-PORT interface
USB programming adapter for configuring modules with Windows software
Bluetooth programming adapter, with USB and S-PORT interface

MINI Analog Pro – Highly compact signal conditioners with plug-in connection technology

Order key for MINI MCR-2-UNI-UI-UIRO-(PT)-(C) 4-way signal conditioners (standard configuration entered as an example)

Order No.	Input			Output			Measuring range limit	Cut-off frequency
	Input signal	Start	End	Output signal	Start	End		
2902024	I	0.0	20.0	I	0.0	20.0	0	15
2902024 ≙ MINI MCR-2-UNI-UI-UIRO-C	I ≙ I U ≙ U	0.0 ≙ 0 mA I: freely selectable between 0.0 ... 24 mA U: freely selectable between 0.0 ... 12 V	20.0 ≙ 20 mA I: freely selectable between 0.0 ... 24 mA U: freely selectable between 0.0 ... 12 V	I ≙ I U ≙ U	0.0 ≙ 0 mA I: freely selectable between 0.0 ... 21 mA U: freely selectable between 0.0 ... 10.5 V	20.0 ≙ 20 mA I: freely selectable between 0.0 ... 21 mA U: freely selectable between 0.0 ... 10.5 V	0 ≙ OFF 1 ≙ AN	15 ≙ 15 Hz 60 ≙ 60 Hz
2902027 ≙ MINI MCR-2-UNI-UI-UIRO-PT-C								

Measuring range span at least 0.5 V / 1 mA
Increment 0.1 V / 0.1 mA

Output signal span at least 0.5 V / 1 mA
Increment 0.1 V / 0.1 mA

Failure information

Behavior in the event of an error

Open circuit / short circuit

Measuring value over-range

Measured value under-range

...	NE43DO	0.0	0.0	0.0
FD ≙ Freely definable		0.0 ≙ 0 mA I: freely selectable between 0.0 ... 21.5 mA U: freely selectable between 0.0 ... 11 V (free definition only for unlimited output) (signal type corresponds to selected output signal)	0.0 ≙ 0 mA I: freely selectable between 0.0 ... 21.5 mA U: freely selectable between 0.0 ... 11 V (free definition only for unlimited output) (signal type corresponds to selected output signal)	0.0 ≙ 0 mA I: freely selectable between 0.0 ... 21.5 mA U: freely selectable between 0.0 ... 11 V (free definition only for unlimited output) (signal type corresponds to selected output signal)
Note: Failure information in accordance with NE 43 can only be selected for 4 ... 20 mA output				
NE43UP ≙ NE 43 upscale		21.5 mA	21.5 mA	21.5 mA
NE43DO ≙ NE 43 downscale		3.5 mA	3.5 mA	3.5 mA
NE430 ≙ NE 43 0 mA		0 mA	0 mA	0 mA
NE43UD ≙ NE 43 upscale/downscale		3.5 mA	21.5 mA	21.5 mA

Analogue IN/Analogue OUT
4-way signal duplicators

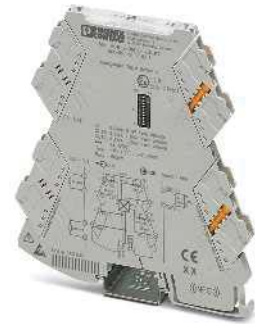
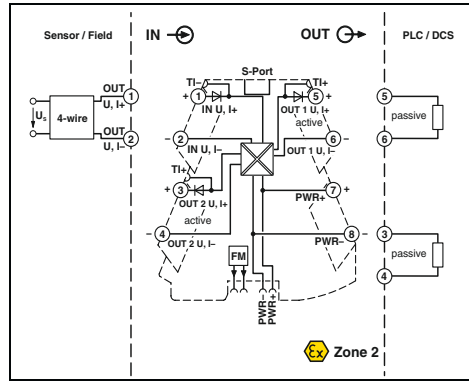
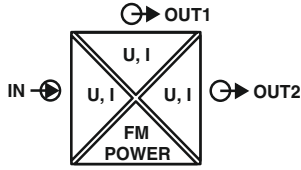

4-way signal duplicator



Housing width 6.2 mm

- Universally configurable, highly-compact 4-way signal duplicator
- For electrical isolation, conversion, amplification, and filtering of standard signals
- Independently adjustable outputs
- Input side for current signals from 0 to 24 mA or voltage signals from 0 to 12 V
- Supports fault monitoring
- Plug-in connection system
- Safe 4-way isolation
- Standard behavior can be configured via DIP switches
- Freely configurable via software or smartphone app
- Power supply and fault monitoring possible via DIN rail connector
- Status and error indicator LEDs

Notes:
To order a product with an order configuration, enter the required configuration by referring to the adjacent order key.

Input data	Input signal (configurable via DIP switch or freely via software)
Maximum input signal	12 V
Input resistance	>120 kΩ
Output data	Output signal (configurable via DIP switch or freely via software)
Maximum output signal	24 mA
No-load voltage	≤18.5 V
Short-circuit current	≤25 mA
Load R _B	≥10 kΩ
Ripple	<20 mV _{PP} (at 600 Ω)
General data	
Supply voltage range	9.6 V DC ... 30 V DC
Nominal supply voltage	24 V DC
Current consumption	55 mA (24 V DC)
Power consumption	1.5 W (at I _{OUT} = 20 mA, 9.6 V DC, 600 Ω load)
Maximum transmission error	0.05% (of final value)
Temperature coefficient	0.01%/K
Step response (10-90%)	Approx. 140 ms (15 Hz sample rate) Approx. 45 ms (60 Hz sample rate) Approx. 25 ms (240 Hz sample rate)
Electrical isolation	Reinforced insulation in accordance with IEC 61010-1
Degree of protection	IP20
EMC note	Class A product, see page 583
Conformance/approvals	
Conformance	CE-compliant
ATEX	Ex II 3 G Ex nA IIC T4 Gc X
UL, USA/Canada	UL 508 Listed Class I, Div. 2, Groups A, B, C, D T6 Class I, Zone 2, Group IIC T6 B, B, A, A
DNV GL	

Technical data

U input	0 V ... 10 V	I input	0 mA ... 20 mA
	2 V ... 10 V		4 mA ... 20 mA
	0 V ... 5 V		0 mA ... 10 mA
	1 V ... 5 V		20 mA ... 0 mA
	0 V ... 12 V		0 mA ... 24 mA
	12 V		24 mA
	>120 kΩ		Approx. 50 Ω (+ 0.7 V for test diode)
U output	0 V ... 10 V	I output	0 mA ... 20 mA
	2 V ... 10 V		4 mA ... 20 mA
	0 V ... 5 V		0 mA ... 10 mA
	1 V ... 5 V		20 mA ... 0 mA
	0 V ... 10.5 V		0 mA ... 21 mA
	Approx. 12.3 V		24.6 mA
	≤25 mA		≤18.5 V
	≥10 kΩ		≤600 Ω (per channel)
	<20 mV _{PP} (at 600 Ω)		<20 mV _{PP} (at 600 Ω)
U output	9.6 V DC ... 30 V DC	I output	110 mA (12 V DC)
	24 V DC		1.5 W (at I _{OUT} = 20 mA, 9.6 V DC, 600 Ω load)
	55 mA (24 V DC)		
	0.05% (of final value)		
	0.01%/K		
	Approx. 140 ms (15 Hz sample rate)		
	Approx. 45 ms (60 Hz sample rate)		
	Approx. 25 ms (240 Hz sample rate)		
	Reinforced insulation in accordance with IEC 61010-1		
	IP20		
	Class A product, see page 583		
	CE-compliant		
	Ex II 3 G Ex nA IIC T4 Gc X		
	UL 508 Listed		
	Class I, Div. 2, Groups A, B, C, D T6		
	Class I, Zone 2, Group IIC T6		
	B, B, A, A		

Ordering data

Description	
4-way signal duplicator , with independently adjustable outputs	
Standard configuration	Push-in connection
Standard configuration	Screw connection
Order configuration	Push-in connection
Order configuration	Screw connection

Type	Order No.	Pcs./Pkt.
MINI MCR-2-UNI-UI-2UI-PT	2905028	1
MINI MCR-2-UNI-UI-2UI	2905026	1
MINI MCR-2-UNI-UI-2UI-PT-C	2905027	1
MINI MCR-2-UNI-UI-2UI-C	2905025	1

Accessories

Programming adapter for configuring modules with S-PORT interface	
USB programming adapter for configuring modules with Windows software	
Bluetooth programming adapter , with USB and S-PORT interface	

IFS-USB-PROG-ADAPTER	2811271	1
TWN4 MIFARE NFC USB ADAPTER	2909681	1
IFS-BT-PROG-ADAPTER	2905872	1

MINI Analog Pro – Highly compact signal conditioners with plug-in connection technology

Order key for MINI MCR-2-UNI-UI-2UI(-PT)(-C) 4-way signal duplicators (standard configuration entered as an example)

Order No.	Input			Output 1			Output 2			...
	Input signal	Start	End	Output signal 1	Start	End	Output signal 2	Start	End	
2905027	I	0.0	20.0	I	0.0	20.0	I	0.0	20.0	...
2905025 ≙ MINI MCR-2-UNI-UI-2UI-C	I ≙ I U ≙ U	0.0 ≙ 0 mA I: freely selectable between 0.0 ... 23.5 mA U: freely selectable between 0.0 ... 11.5 V	20.0 ≙ 20 mA I: freely selectable between 0.0 ... 24 mA U: freely selectable between 0.5 ... 12 V	I ≙ I U ≙ U	0.0 ≙ 0 mA I: freely selectable between 0.0 ... 20 mA U: freely selectable between 0.0 ... 10.5 V	20.0 ≙ 20 mA I: freely selectable between 1.0 ... 21 mA U: freely selectable between 0.5 ... 11 V	I ≙ I U ≙ U	0.0 ≙ 0 mA I: freely selectable between 0.0 ... 20 mA U: freely selectable between 0.0 ... 10.5 V	20.0 ≙ 20 mA I: freely selectable between 1.0 ... 21 mA U: freely selectable between 0.5 ... 11 V	...
2905027 ≙ MINI MCR-2-UNI-UI-2UI-PT-C										
Measuring range span at least 0.5 V / 1 mA Increment 0.1 V / 0.1 mA				Output signal span at least 0.5 V / 1 mA Increment 0.1 V / 0.1 mA						

Sample rate	Factory calibration certificate
15	None
15 ≙ 15 Hz 60 ≙ 60 Hz 250 ≙ 240 Hz	None ≙ no factory calibration certificate Yes ≙ certificate but no test data YesPlus ≙ certificate with test data

Analog IN/Analog OUT
3-way signal conditioners

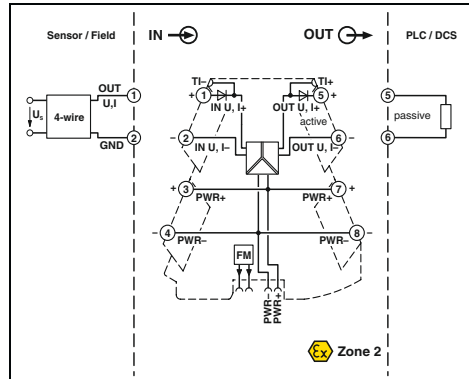
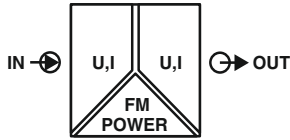

3-way signal conditioner for standard signals, configurable

Housing width 6.2 mm

- Configurable, ultra-compact signal conditioner for electrical isolation, conversion, amplification, and filtering of standard analog signals
- Plug-in connection system
- Safe 3-way isolation
- Standard signal combinations configurable via DIP switches
- Power supply and fault monitoring possible via DIN rail connector
- Status LED

Notes:
Information on MINI Analog Pro accessories can be found from page 107
To order a product with an order configuration, please enter the desired configuration by referring to the order key.

Input data	Input signal (configurable using the DIP switch)
Output data	Output signal (configurable using the DIP switch)
General data	Supply voltage range Nominal supply voltage Current consumption
Power consumption	
Conformance/approvals	ATEX UL, USA/Canada
DNV GL	

Technical data	
U input	I input
0 V ... 5 V	0 mA ... 20 mA
1 V ... 5 V	4 mA ... 20 mA
-5 V ... 5 V	-20 mA ... 20 mA
0 V ... 10 V	
2 V ... 10 V	
-10 V ... 10 V	
0 V ... 20 V	
4 V ... 20 V	
-20 V ... 20 V	
0 V ... 24 V	
4.8 V ... 24 V	
-24 V ... 24 V	
0 V ... 30 V	
6 V ... 30 V	
-30 V ... 30 V	
>1,000 kΩ	Approx. 63 Ω (+ 0.7 V for test diode)
U output	I output
0 V ... 5 V	0 mA ... 20 mA
1 V ... 5 V	4 mA ... 20 mA
-5 V ... 5 V	
0 V ... 10 V	
2 V ... 10 V	
-10 V ... 10 V	
<32 mA	22 mA
≥10 kΩ	<17 V
<20 mV _{pp} (at 600 Ω)	≤600 Ω (at 20 mA)
U output	I output
9.6 V DC ... 30 V DC	
24 V DC	
25 mA (current output, at 24 V DC incl. load)	54 mA (current output, at 12 V DC incl. load)
	≤800 mW (at I _{OUT} = 20 mA, 9.6 V DC, 600 Ω load)
Maximum transmission error	≤0.1% (of final value)
Temperature coefficient	0.01%/K, typically 0.01%/K
Limit frequency (3 dB)	30 Hz (via DIP switch)
Step response (10-90%)	<8.5 ms (with 30 Hz filter)
Electrical isolation	Reinforced insulation in accordance with IEC 61010-1
Degree of protection	IP20
EMC note	Class A product, see page 583
Conformance/approvals	CE-compliant Ex II 3 G Ex nA IIC T4 Gc X UL 508 Listed Class I, Div. 2, Groups A, B, C, D T6 Class I, Zone 2, Group IIC T6 C, EMC2

Ordering data			
Description	Type	Order No.	Pcs./Pkt.
3-way signal conditioner , for electrical isolation of analog signals			
Standard configuration	Push-in connection	MINI MCR-2-UI-UI-PT	1
Standard configuration	Screw connection	MINI MCR-2-UI-UI	1
Order configuration	Push-in connection	MINI MCR-2-UI-UI-PT-C	1
Order configuration	Screw connection	MINI MCR-2-UI-UI-C	1

MINI Analog Pro – Highly compact signal conditioners with plug-in connection technology

Order key for MINI MCR-2-UI-UI(-PT)(-C) 3-way signal conditioners (standard configuration entered as an example)

Order No.	Input	Output	Cut-off frequency
2902036	IN03	OUT01	5K
2902036 ≙ MINI MCR-2-UI-UI-C	IN 01 ≙ 0 ... 20 mA IN 02 ≙ 4 ... 20 mA IN 03 ≙ 0 ... 10 V IN 04 ≙ 2 ... 10 V IN 05 ≙ 0 ... 5 V IN 06 ≙ 1 ... 5 V IN 21 ≙ -5 ... 5 V IN 22 ≙ -10 ... 10 V IN 23 ≙ -20 ... 20 V IN 32 ≙ 0 ... 20 V IN 35 ≙ -20 ... 20 mA IN 38 ≙ 0 ... 24 V IN 39 ≙ 0 ... 30 V IN 80 ≙ -30 ... 30 V IN 93 ≙ -24 ... 24 V IN 94 ≙ 4.8 ... 24 V IN 95 ≙ 6 ... 30 V IN 96 ≙ 4 ... 20 V	OUT 01 ≙ 0 ... 20 mA OUT 02 ≙ 4 ... 20 mA OUT 03 ≙ 0 ... 10 V OUT 04 ≙ 2 ... 10 V OUT 05 ≙ 0 ... 5 V OUT 06 ≙ 1 ... 5 V OUT 13 ≙ -5 ... 5 V OUT 14 ≙ -10 ... 10 V	30 Hz 5 kHz
2902039 ≙ MINI MCR-2-UI-UI-PT-C			

Signal combinations for MINI MCR-2-UI-UI(-PT)(-C) signal conditioners

Input	Output							
	0 ... 20 mA	4 ... 20 mA	0 ... 5 V	1 ... 5 V	-5 ... 5 V	0 ... 10 V	2 ... 10 V	-10 ... 10 V
0 ... 20 mA	X	X	X	X	X	X	X	X
4 ... 20 mA	X	X	X	X	X	X	X	X
-20 ... 20 mA	X	X	X	X	X	X	X	X
0 ... 5 V	X	X	X	X	X	X	X	X
1 ... 5 V	X	X	X	X	X	X	X	X
-5 ... 5 V	X	X	X	X	X	X	X	X
0 ... 10 V	X	X	X	X	X	X	X	X
2 ... 10 V	X	X	X	X	X	X	X	X
-10 ... 10 V	X	X	X	X	X	X	X	X
0 ... 20 V	X	X	X	X	X	X	X	X
4 ... 20 V	X	X	X	X	X	X	X	X
-20 ... 20 V	X	X	X	X	X	X	X	X
0 ... 24 V	X	X	X	X	X	X	X	X
4.8 ... 24 V	X	X	X	X	X	X	X	X
-24 ... 24 V	X	X	X	X	X	X	X	X
0 ... 30 V	X	X	X	X	X	X	X	X
6 ... 30 V	X	X	X	X	X	X	X	X
-30 ... 30 V	X	X	X	X	X	X	X	X

Analog IN/Analog OUT
3-way signal conditioners

new

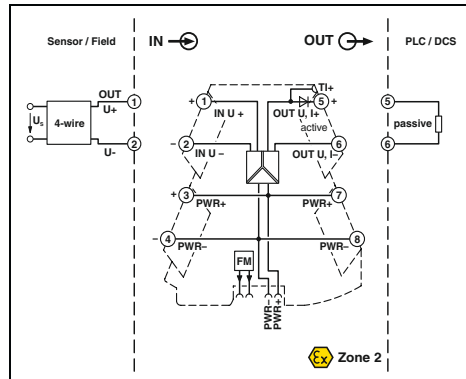
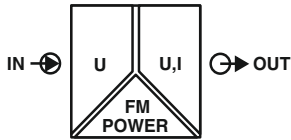

3-way signal conditioner for standard signals, configurable

Housing width 6.2 mm

- Configurable 3-way signal conditioner with plug-in connection technology
- Input and output signal range configurable via DIP switches
- Input signal range from ± 50 mV to ± 30 V
- Bipolar input/output signals
- Calibrated measuring range switch-over
- Approval for Ex zone 2 (nA)
- Screw or Push-in connection
- Reinforced insulation in accordance with IEC 61010-1
- Supply voltage range of 9.6 V ... 30 V DC

Notes:
Information on MINI Analog Pro accessories can be found from page 107
To order a product with an order configuration, please enter the desired configuration by referring to the order key.

Input data
Input signal (configurable using the DIP switch)
Input resistance
Output data
Output signal (configurable using the DIP switch)
Maximum output signal
No-load voltage
Short-circuit current
Load R_B
Ripple
General data
Supply voltage range
Nominal supply voltage
Current consumption
Power consumption
Maximum transmission error
Temperature coefficient
Limit frequency (3 dB)
Step response (10-90%)
Electrical isolation
Degree of protection
Conformance/approvals
Conformance
ATEX
UL, USA/Canada
DNV GL

Technical data	
See table	
>10 k Ω	
U output	I output
0 V ... 5 V	0 mA ... 20 mA
1 V ... 5 V	4 mA ... 20 mA
-5 V ... 5 V	
0 V ... 10 V	
2 V ... 10 V	
-10 V ... 10 V	
	22 mA
	<17 V
<32 mA	
≥ 10 k Ω	$\leq 600 \Omega$ (at 20 mA)
<20 mV _{PP} (at 600 Ω)	<20 mV _{PP} (at 600 Ω)
U output	I output
9.6 V DC ... 30 V DC	
24 V DC	
25 mA (current output, at 24 V DC incl. load)	54 mA (current output, at 12 V DC incl. load)
	≤ 800 mW (at $I_{OUT} = 20$ mA, 9.6 V DC, 600 Ω load)
$\leq 0.1\%$ (of final value)	
0.01%/K	
30 Hz (via DIP switch)	
<8.5 ms (with 30 Hz filter)	
Reinforced insulation in accordance with IEC 61010-1	
IP20	
CE-compliant	
Ex II 3 G Ex nA IIC T4 Gc X	
UL 508 Listed	
Class I, Div. 2, Groups A, B, C, D T6	
Class I, Zone 2, Group IIC T6	
-	

Description	Connection
Standard configuration	Push-in connection
Standard configuration	Screw connection
Order configuration	Push-in connection
Order configuration	Screw connection

Ordering data		
Type	Order No.	Pcs./Pkt.
MINI MCR-2-U-UI-PT	2902021	1
MINI MCR-2-U-UI	2902019	1
MINI MCR-2-U-UI-PT-C	2902020	1
MINI MCR-2-U-UI-C	2902018	1

MINI Analog Pro – Highly compact signal conditioners with plug-in connection technology

Order key for MINI MCR-2-U-UI(-PT)(-C) 3-way signal conditioners (standard configuration entered as an example)

Order No.	Input	Output	Cut-off frequency	
2902018	IN03	OUT01	5K	
2902018 ≙ MINI MCR-2- U-UI-C	IN40 ≙ 0 ... 50 mV IN53 ≙ ±50 mV IN24 ≙ 0 ... 60 mV IN13 ≙ ±60 mV IN41 ≙ 0 ... 75 mV IN54 ≙ ±75 mV IN42 ≙ 0 ... 80 mV IN55 ≙ ±80 mV IN25 ≙ 0 ... 100 mV IN14 ≙ ±100 mV IN43 ≙ 0 ... 120 mV IN56 ≙ ±120 mV IN44 ≙ 0 ... 150 mV IN57 ≙ ±150 mV IN26 ≙ 0 ... 200 mV IN15 ≙ ±200 mV IN45 ≙ 0 ... 240 mV IN58 ≙ ±240 mV IN27 ≙ 0 ... 300 mV IN16 ≙ ±300 mV IN28 ≙ 0 ... 500 mV IN17 ≙ ±500 mV IN46 ≙ 0 ... 600 mV IN59 ≙ ±600 mV IN47 ≙ 0 ... 750 mV IN60 ≙ ±750 mV IN48 ≙ 0 ... 800 mV IN61 ≙ ±800 mV	IN29 ≙ 0 ... 1 V IN18 ≙ ±1 V IN49 ≙ 0 ... 1.2 V IN62 ≙ ±1.2 V IN50 ≙ 0 ... 1.5 V IN63 ≙ ±1.5 V IN30 ≙ 0 ... 2 V IN19 ≙ ±2 V IN51 ≙ 0 ... 2.4 V IN64 ≙ ±2.4 V IN52 ≙ 0 ... 3 V IN65 ≙ ±3 V IN05 ≙ 0 ... 5 V IN21 ≙ ±5 V IN100 ≙ 0 ... 7.5 V IN107 ≙ ±7.5 V IN03 ≙ 0 ... 10 V IN22 ≙ ±10 V IN101 ≙ 0 ... 12 V IN108 ≙ ±12 V IN67 ≙ 0 ... 15 V IN79 ≙ ±15 V IN32 ≙ 0 ... 20 V IN23 ≙ ±20 V IN38 ≙ 0 ... 24 V IN93 ≙ ±24 V IN39 ≙ 0 ... 30 V IN80 ≙ ±30 V	OUT 01 ≙ 0 ... 20 mA OUT 02 ≙ 4 ... 20 mA OUT 03 ≙ 0 ... 10 V OUT 04 ≙ 2 ... 10 V OUT 05 ≙ 0 ... 5 V OUT 06 ≙ 1 ... 5 V OUT 13 ≙ -5 ... 5 V OUT 14 ≙ -10 ... 10 V	30 Hz 5 kHz

Signal combinations for MINI MCR-2-U-UI(-PT)(-C) signal conditioners

Input	Output							
	0 ... 20 mA	4 ... 20 mA	0 ... 5 V	1 ... 5 V	-5 ... 5 V	0 ... 10 V	2 ... 10 V	-10 ... 10 V
0 ... 50 mV (±50 mV)	X	X	X	X	X	X	X	X
0 ... 60 mV (±60 mV)	X	X	X	X	X	X	X	X
0 ... 75 mV (±75 mV)	X	X	X	X	X	X	X	X
0 ... 80 mV (±80 mV)	X	X	X	X	X	X	X	X
0 ... 100 mV (±100 mV)	X	X	X	X	X	X	X	X
0 ... 120 mV (±120 mV)	X	X	X	X	X	X	X	X
0 ... 150 mV (±150 mV)	X	X	X	X	X	X	X	X
0 ... 200 mV (±200 mV)	X	X	X	X	X	X	X	X
0 ... 240 mV (±240 mV)	X	X	X	X	X	X	X	X
0 ... 300 mV (±300 mV)	X	X	X	X	X	X	X	X
0 ... 500 mV (±500 mV)	X	X	X	X	X	X	X	X
0 ... 600 mV (±600 mV)	X	X	X	X	X	X	X	X
0 ... 750 mV (±750 mV)	X	X	X	X	X	X	X	X
0 ... 800 mV (±800 mV)	X	X	X	X	X	X	X	X
0 ... 1 V (±1 V)	X	X	X	X	X	X	X	X
0 ... 1.2 V (±1.2 V)	X	X	X	X	X	X	X	X
0 ... 1.5 V (±1.5 V)	X	X	X	X	X	X	X	X
0 ... 2 V (±2 V)	X	X	X	X	X	X	X	X
0 ... 2.4 V (±2.4 V)	X	X	X	X	X	X	X	X
0 ... 3 V (±3 V)	X	X	X	X	X	X	X	X
0 ... 5 V (±5 V)	X	X	X	X	X	X	X	X
0 ... 7.5 V (±7.5 V)	X	X	X	X	X	X	X	X
0 ... 10 V (±10 V)	X	X	X	X	X	X	X	X
0 ... 12 V (±12 V)	X	X	X	X	X	X	X	X
0 ... 15 V (±15 V)	X	X	X	X	X	X	X	X
0 ... 20 V (±20 V)	X	X	X	X	X	X	X	X
0 ... 24 V (±24 V)	X	X	X	X	X	X	X	X
0 ... 30 V (±30 V)	X	X	X	X	X	X	X	X

Unipolar or bipolar selection option available for input signal via DIP switch.

Analog IN/Analog OUT
3-way signal conditioners

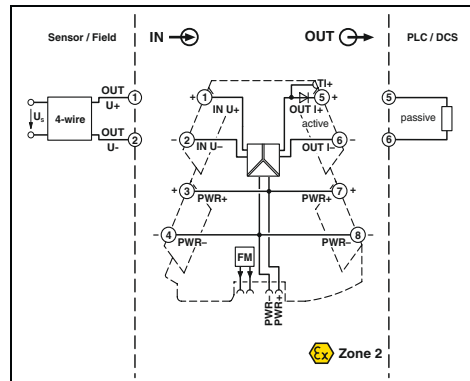
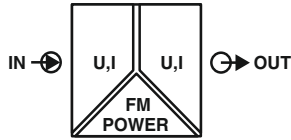

3-way signal conditioner with fixed signal combinations



- Highly compact signal conditioners for electrical isolation, conversion, amplification, and filtering of standard analog signals
- Fixed signal combinations
- Plug-in connection system
- Safe 3-way isolation
- Power supply and fault monitoring possible via DIN rail connector
- Status LED

Notes:
Information on MINI Analog Pro accessories can be found from page 107

Input data	U input	I input
Input resistance	Approx. 1 MΩ	Approx. 63 Ω (+ 0.7 V for test diode)
Output data	U output	I output
Maximum output signal	11 V	22 mA
No-load voltage	<15 mA	<17 V
Short-circuit current	≥10 kΩ	≤600 Ω (at 20 mA)
Load R _B	<20 mV _{pp} (at 10 kΩ)	<20 mV _{pp} (at 600 Ω)
Ripple		
General data		
Supply voltage U _B	9.6 V DC ... 30 V DC	
Nominal supply voltage	24 V DC	
Typ. current consumption	25 mA (24 V DC)	
Maximum transmission error	0.1% (of final value)	
Temperature coefficient	0.01%/K, typically 0.01%/K	
Limit frequency (3 dB)	Approx. 30 Hz	
Step response (10-90%)	Approx. 10 ms	
Degree of protection	IP20	
Electrical isolation	Reinforced insulation in accordance with IEC 61010-1	
EMC note	Class A product, see page 583	
Conformance/approvals		
Conformance	CE-compliant	
ATEX	Ex II 3 G Ex nA IIC T4 Gc X	
UL, USA/Canada	UL 508 Listed Class I, Div. 2, Groups A, B, C, D T6 Class I, Zone 2, Group IIC T6 C, EMC2	
DNV GL		

Technical data		
U input	I input	
Approx. 1 MΩ	Approx. 63 Ω (+ 0.7 V for test diode)	
U output	I output	
11 V	22 mA	
<15 mA	<17 V	
≥10 kΩ	≤600 Ω (at 20 mA)	
<20 mV _{pp} (at 10 kΩ)	<20 mV _{pp} (at 600 Ω)	
9.6 V DC ... 30 V DC		
24 V DC		
25 mA (24 V DC)		
0.1% (of final value)		
0.01%/K, typically 0.01%/K		
Approx. 30 Hz		
Approx. 10 ms		
IP20		
Reinforced insulation in accordance with IEC 61010-1		
Class A product, see page 583		
CE-compliant		
Ex II 3 G Ex nA IIC T4 Gc X		
UL 508 Listed		
Class I, Div. 2, Groups A, B, C, D T6		
Class I, Zone 2, Group IIC T6		
C, EMC2		

Description	Input signal	Output signal
3-way signal conditioner , for electrical isolation of analog signals		
Push-in connection	0 ... 10 V	0 ... 20 mA
Screw connection	0 ... 10 V	0 ... 20 mA
Push-in connection	0 ... 10 V	4 ... 20 mA
Screw connection	0 ... 10 V	4 ... 20 mA
Push-in connection	0 ... 20 mA	0 ... 10 V
Screw connection	0 ... 20 mA	0 ... 10 V
Push-in connection	4 ... 20 mA	0 ... 10 V
Screw connection	4 ... 20 mA	0 ... 10 V
Push-in connection	0 ... 20 mA	0 ... 20 mA
Screw connection	0 ... 20 mA	0 ... 20 mA
	4 ... 20 mA	4 ... 20 mA
Push-in connection	0 ... 10 V	0 ... 10 V
Screw connection	-10 ... 10 V	-10 ... 10 V
	0 ... 10 V	0 ... 10 V
	-10 ... 10 V	-10 ... 10 V

Ordering data		
Type	Order No.	Pcs./Pkt.
MINI MCR-2-U-I0-PT	2902023	1
MINI MCR-2-U-I0	2902022	1
MINI MCR-2-U-I4-PT	2902030	1
MINI MCR-2-U-I4	2902029	1
MINI MCR-2-I0-U-PT	2902001	1
MINI MCR-2-I0-U	2902000	1
MINI MCR-2-I4-U-PT	2902003	1
MINI MCR-2-I4-U	2902002	1
MINI MCR-2-I-I-PT	2901999	1
MINI MCR-2-I-I	2901998	1
MINI MCR-2-U-U-PT	2902043	1
MINI MCR-2-U-U	2902042	1

Analog IN/Analog OUT
3-way repeater power supplies

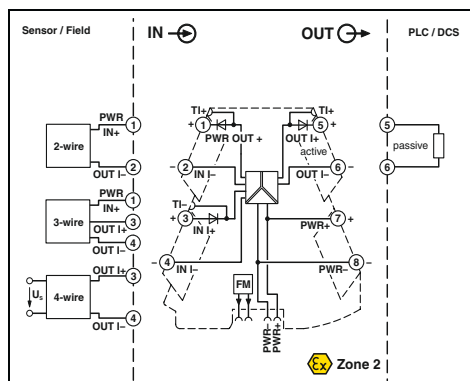
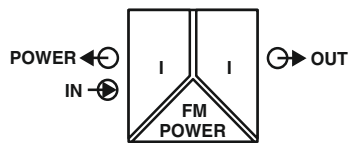

3-way repeater power supply



Housing width 6.2 mm

- Highly compact repeater power supply for electrical isolation, amplification, and filtering of standard analog signals
- Supply of 2-conductor and passive 3-conductor sensors
- Can also be used as an isolator without supply
- Plug-in connection system
- Safe 3-way isolation
- Power supply and fault monitoring possible via DIN rail connector
- Status LED

Notes:

Information about power bridging, system cabling, and marking components can be found starting at page 102

Input data	Input signal
Input resistance	Transmitter supply voltage
Output data	Output signal
Maximum output signal	No-load voltage
Load R_B	Ripple
General data	Supply voltage range
Nominal supply voltage	Current consumption
Power consumption	Maximum transmission error
Temperature coefficient	Limit frequency (3 dB)
Step response (10-90%)	Electrical isolation
Degree of protection	EMC note
Conformance/approvals	Conformance
ATEX	UL, USA/Canada
DNV GL	

Technical data

0 ... 20 mA, isolator operation / 4 ... 20 mA, repeater power supply and isolator operation
Approx. 68 Ω (+ 0.7 V for test diode)
>19.5 V
0 ... 20 mA / 4 ... 20 mA
24 mA
<20 V
≤600 Ω (at 20 mA)
<20 mV _{pp} (at 600 Ω)
9.6 V DC ... 30 V DC
24 V DC
25 mA (at 24 V DC and in isolator operation)
≤1400 mW (at I _{OUT} = 20 mA, 9.6 V DC, 600 Ω load)
0.05% (of final value, at 4 mA ... 20 mA)
0.0075%/K, typically 0.0075%/K
>1.75 kHz (typically)
<200 μs (typically)
Reinforced insulation in accordance with IEC 61010-1
IP20
Class A product, see page 583
CE-compliant
Ex II 3 G Ex nA IIC T4 Gc X
UL 508 Listed
Class I, Div. 2, Groups A, B, C, D T5
Class I, Zone 2, Group IIC T5
C, EMC2

Ordering data

Description	Type	Order No.	Pcs./Pkt.	
3-way repeater power supplies	Push-in connection	MINI MCR-2-RPSS-I-I-PT	2902015	1
	Screw connection	MINI MCR-2-RPSS-I-I	2902014	1

Analog IN / Analog OUT
Power supply doublers

new

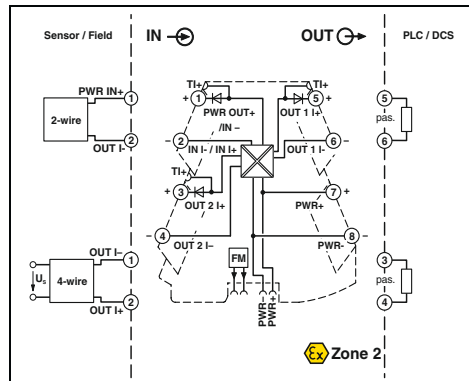
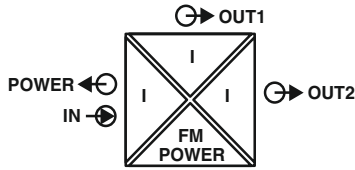

Power supply doubler with HART transmission



Housing width 6.2 mm

- Highly compact power supply doubler with electrical isolation for doubling, amplifying, and filtering standard analog signals
- Supply of 2-conductor sensors
- Can also be used as an isolator without supply
- Plug-in connection system
- Safe 3-way isolation
- Power supply and fault monitoring possible via DIN rail connector
- Status LED

Input data
Input signal

Input resistance
Transmitter supply voltage

Output data
Output signal
Maximum output signal
No-load voltage
Load R_B
Ripple

General data
Supply voltage range
Nominal supply voltage
Current consumption
Power consumption
Maximum transmission error
Temperature coefficient
Limit frequency (3 dB)
Step response (10-90%)
Electrical isolation
Degree of protection
EMC note

Conformance/approvals

Conformance
ATEX
UL, USA/Canada

DNV GL

Technical data

0 ... 20 mA, isolator operation /
4 ... 20 mA, repeater power supply and isolator operation

90 Ω (+1.6 V)
>19.5 V

0 ... 20 mA / 4 ... 20 mA
25 mA
<20 V
 $\leq 500 \Omega$ (per channel)
<20 mV_{pp} (at 500 Ω)

9.6 V DC ... 30 V DC
24 V DC
40 mA (at 24 V DC and in isolator operation)
1.6 W (at $I_{OUT} = 20$ mA, 500 Ω load)
0.05% (of final value)
0.0075%/K,
>1 kHz (typically)
<400 μ s (typically)
Reinforced insulation in accordance with IEC 61010-1
IP20
Class A product, see page 583

CE-compliant
Ex II 3 G Ex nA IIC T4 Gc X
UL 508 Listed
Class I, Div. 2, Groups A, B, C, D T5
Class I, Zone 2, Group IIC T5
B, B, A, A

Ordering data

Description

4-way power supply doubler, with HART transmission and automatic active/passive detection at the outputs

Push-in connection
Screw connection

Type

MINI MCR-2-RPSS-I-2I-PT
MINI MCR-2-RPSS-I-2I

Order No.

2905629
2905628

Pcs./Pkt.

1
1

new

Analog IN / Analog OUT
2-way repeater power supplies,
output loop-powered

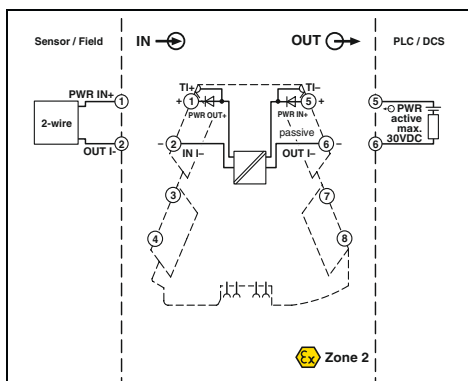
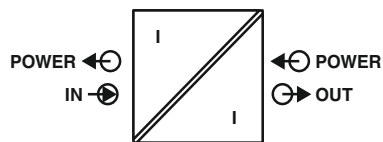

Either 1- or 2-channel



Ex:
 Housing width 6.2 mm

- The single or dual-channel output loop-powered 2-way repeater power supply with plug-in connection technology is used for the electrical isolation and filtering of analog signals
- This device allows operation on an active analog input module
- The module and the connected sensors are powered via the current loop of the controller
- As a result, no additional power supply is required
- Input signal = output signal: 0(4) mA ... 20 mA

Input data	
Input signal	0 ... 20 mA / 4 ... 20 mA
Transmitter supply voltage	U _A - 5 V
Output data	
Output signal	0 ... 20 mA / 4 ... 20 mA
Output signal	5 V ... 30 V
General data	
Maximum transmission error	≤ 0.1% (at 5 V)
Additional error, depending on the input voltage	(U _A - 5 V) x 0.06%
Temperature coefficient	≤ 0.001%/K
Limit frequency (3 dB)	100 Hz
Electrical isolation	Reinforced insulation in accordance with IEC 61010-1
Degree of protection	IP20
EMC note	Class A product, see page 583
Conformance/approvals	
Conformance	CE-compliant
ATEX	II 3 G Ex nA IIC T4 Gc X
UL, USA/Canada	UL 508 Listed Class I, Div. 2, Groups A, B, C, D T6 Class I, Zone 2, Group IIC T6

Technical data

Input data	
Input signal	0 ... 20 mA / 4 ... 20 mA
Transmitter supply voltage	U _A - 5 V
Output data	
Output signal	0 ... 20 mA / 4 ... 20 mA
Output signal	5 V ... 30 V
General data	
Maximum transmission error	≤ 0.1% (at 5 V)
Additional error, depending on the input voltage	(U _A - 5 V) x 0.06%
Temperature coefficient	≤ 0.001%/K
Limit frequency (3 dB)	100 Hz
Electrical isolation	Reinforced insulation in accordance with IEC 61010-1
Degree of protection	IP20
EMC note	Class A product, see page 583
Conformance/approvals	
Conformance	CE-compliant
ATEX	II 3 G Ex nA IIC T4 Gc X
UL, USA/Canada	UL 508 Listed Class I, Div. 2, Groups A, B, C, D T6 Class I, Zone 2, Group IIC T6

Ordering data

Description	
Output loop-powered 2-way repeater power supply, for isolating current signals without auxiliary power	
Push-in connection	MINI MCR-2-RPS-I-I-OLP-PT
Screw connection	MINI MCR-2-RPS-I-I-OLP
Push-in connection	MINI MCR-2-RPS-2I-2I-OLP-PT
Screw connection	MINI MCR-2-RPS-2I-2I-OLP

Type	Order No.	Pcs./Pkt.
MINI MCR-2-RPS-I-I-OLP-PT	2906447	1
MINI MCR-2-RPS-I-I-OLP	2906446	1
MINI MCR-2-RPS-2I-2I-OLP-PT	2906449	1
MINI MCR-2-RPS-2I-2I-OLP	2906448	1

Analog IN/Analog OUT
2-way passive isolators,
input loop-powered

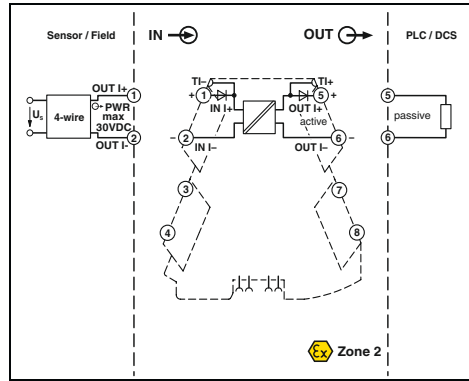
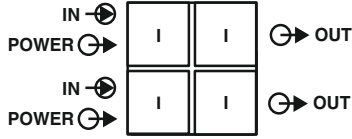

Either 1- or 2-channel

Ex:
Housing width 6.2 mm

- Highly-compact 2-way repeater power supply
- Input loop-supplied
- Does not require any additional auxiliary voltage
- For electrical isolation and filtering of analog signals
- Powered via the current loop of the sensor
- Input signal = output signal 0(4) to 20 mA
- Plug-in connection system
- Status LED

Notes:
Information on MINI Analog Pro accessories can be found from page 107

Input data
Input signal
Input voltage limitation
Voltage drop
Response current
Output data
Output signal
Load R_B
Transmission Behavior
General data
Maximum transmission error
Additional error per 100 Ω load
Temperature coefficient
Limit frequency (3 dB)
Electrical isolation
Degree of protection
EMC note
Conformance/approvals
Conformance
ATEX
UL, USA/Canada
GL

Technical data	
0 ... 20 mA / 4 ... 20 mA	
30 V	
3.1 V ($I = 20$ mA)	
Approx. 200 μ A	
0 ... 20 mA / 4 ... 20 mA	
<600 Ω (at $I = 20$ mA output signal)	
1:1 to input signal	
$\leq 0.1\%$ (of final value)	
<0.075% (of measured value / 100 Ω load)	
$\leq 0.002\%/K$ (of measured value / 100 Ω load)	
100 Hz	
Reinforced insulation in accordance with IEC 61010-1	
IP20	
Class A product, see page 583	
CE-compliant	
II 3 G Ex nA IIC T4 Gc X	
UL 508 Listed	
Class I, Div. 2, Groups A, B, C, D T6	
Class I, Zone 2, Group IIC T6	
GL applied for	

Description	
Input loop-powered 2-way isolator , for isolating current signals without auxiliary power	
single-channel	Push-in connection
single-channel	Screw connection
two-channel	Push-in connection
two-channel	Screw connection

Ordering data		
Type	Order No.	Pcs./Pkt.
MINI MCR-2-I-I-LP-PT	2901995	1
MINI MCR-2-I-I-LP	2901994	1
MINI MCR-2-2I-I-LP-PT	2901997	1
MINI MCR-2-2I-I-LP	2901996	1

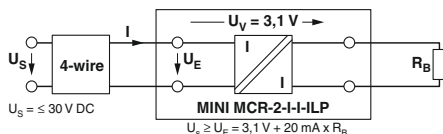

new

Analog IN/Analog OUT
2-way passive isolators,
output loop-powered

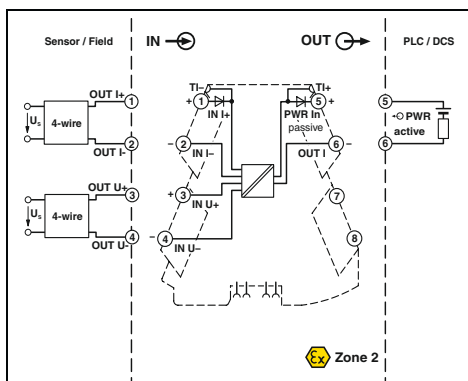
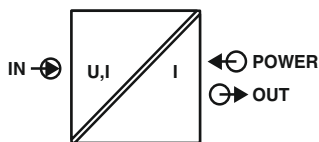

Ex n



Configurable,
up to 74 signal combinations



Housing width 6.2 mm

- Highly-compact passive isolator for electrical isolation and filtering of standard analog signals
- Safe 2-way isolation
- Supplied by an output loop
- Does not require any additional auxiliary voltage
- Up to 74 signal combinations can be configured using DIP switches
- Plug-in connection system
- Voltage input from mV voltages up to 30 V
- Current input from 2 to 40 mA
- Status LED

Notes:
To order a product with an order configuration, please enter the desired configuration by referring to the order key.
Information on MINI Analog Pro accessories can be found from page 107

Input data	Input signal (configurable using the DIP switch)
Maximum input signal	<30 V
Input resistance	Approx. 100 kΩ (at ≤1 V, otherwise approximately 1 MΩ)
Output data	Output signal
Maximum output signal	32 mA
Load R _B	<1,000 Ω ((U _B - 8 V) / 22 mA)
Ripple	<10 mV _{rms} (at 600 Hz)
General data	Current consumption
Maximum transmission error	≤20 mA
Temperature coefficient	≤0.1% (of final value)
Limit frequency (3 dB)	0.01%/K, typically 0.005%/K
Step response (10-90%)	Approx. 30 Hz
Electrical isolation	20 ms
Degree of protection	Reinforced insulation in accordance with IEC 61010-1
EMC note	IP20
Conformance/approvals	Class A product, see page 583
Conformance	CE-compliant
ATEX	Ex II 3 G Ex nA IIC T4 Gc X
UL, USA/Canada	UL 508 Listed
	Class I, Div. 2, Groups A, B, C, D T5
	Class I, Zone 2, Group IIC T5
	B, B, A, A
DNV GL	

Technical data	
U input	I input
2 ... 10 V, additional areas can be configured, see table	
Maximum input signal	50 mA (dielectric strength up to 30 V)
Input resistance	25 Ω (+ 0.7 V for test diode)
Output signal	4 ... 20 mA
Maximum output signal	32 mA
Load R _B	<1,000 Ω ((U _B - 8 V) / 22 mA)
Ripple	<10 mV _{rms} (at 600 Hz)
Current consumption	≤20 mA
Maximum transmission error	≤0.1% (of final value)
Temperature coefficient	0.01%/K, typically 0.005%/K
Limit frequency (3 dB)	Approx. 30 Hz
Step response (10-90%)	20 ms
Electrical isolation	Reinforced insulation in accordance with IEC 61010-1
Degree of protection	IP20
EMC note	Class A product, see page 583
Conformance/approvals	CE-compliant
Conformance	Ex II 3 G Ex nA IIC T4 Gc X
ATEX	UL 508 Listed
UL, USA/Canada	Class I, Div. 2, Groups A, B, C, D T5
	Class I, Zone 2, Group IIC T5
	B, B, A, A

Description	Output loop-powered 2-way isolator , for isolating current signals without auxiliary power
Standard configuration	Push-in connection
Standard configuration	Screw connection
Order configuration	Push-in connection
Order configuration	Screw connection

Ordering data		
Type	Order No.	Pcs./Pkt.
MINI MCR-2-UI-I-OLP-PT	2902063	1
MINI MCR-2-UI-I-OLP	2902061	1
MINI MCR-2-UI-I-OLP-PT-C	2902062	1
MINI MCR-2-UI-I-OLP-C	2902060	1

Order key for MINI MCR-2-UI-I-OLP(-PT)(-C)

Order No.	Input	Output
2902060	0 mV ... 1,000 mV	
2902060 ≙	0 mV ... 1,000 mV	0 V ... 10 V
MINI MCR-2-UI-I-OLP-C	0 mV ... 750 mV	0 V ... 7.5 V
	0 mV ... 500 mV	0 V ... 5 V
	0 mV ... 300 mV	0 V ... 3 V
2902062 ≙	0 mV ... 250 mV	0 V ... 2.5 V
MINI MCR-2-UI-I-OLP-PT-C	0 mV ... 200 mV	0 V ... 2 V
	0 mV ... 150 mV	0 V ... 1.5 V
	0 mV ... 125 mV	0 V ... 1.25 V
	0 mV ... 120 mV	0 V ... 1.2 V
	0 mV ... 100 mV	0 V ... 1 V
	0 mV ... 75 mV	0 V ... 0.75 V
	0 mV ... 60 mV	0 V ... 0.6 V
	0 mV ... 50 mV	0 V ... 0.5 V
		0 V ... 12 V
		0 V ... 15 V
		2 V ... 10 V
		-1,000 mV ... 1,000 mV
		-750 mV ... 750 mV
		-500 mV ... 500 mV
		-300 mV ... 300 mV
		-250 mV ... 250 mV
		-200 mV ... 200 mV
		-125 mV ... 125 mV
		-120 mV ... 120 mV
		-150 mV ... 150 mV
		-100 mV ... 100 mV
		-75 mV ... 75 mV
		-60 mV ... 60 mV
		-50 mV ... 50 mV
		-10 V ... 10 V
		-7.5 V ... 7.5 V
		-5 V ... 5 V
		-3 V ... 3 V
		-2.5 V ... 2.5 V
		-2 V ... 2 V
		-1.25 V ... 1.25 V
		-1.2 V ... 1.2 V
		-1.5 V ... 1.5 V
		-30 V ... 30 V
		-25 V ... 25 V
		-20 V ... 20 V
		-12.5 V ... 12.5 V
		-12 V ... 12 V
		-15 V ... 15 V
		1 V ... 5 V
		0 mA ... 40 mA
		0 mA ... 30 mA
		0 mA ... 20 mA
		0 mA ... 12 mA
		0 mA ... 10 mA
		0 mA ... 8 mA
		0 mA ... 7.5 mA
		0 mA ... 6 mA
		0 mA ... 5 mA
		0 mA ... 4 mA
		0 mA ... 3 mA
		0 mA ... 2.5 mA
		0 mA ... 2 mA
		4 mA ... 20 mA
		2 mA ... 10 mA
		1 mA ... 5 mA
		-2 mA ... 2 mA
		-3 mA ... 3 mA
		-10 mA ... 10 mA
		-15 mA ... 15 mA
		-20 mA ... 20 mA
		-30 mA ... 30 mA
		-40 mA ... 40 mA

Temperature
Temperature transducers
for resistance thermometers

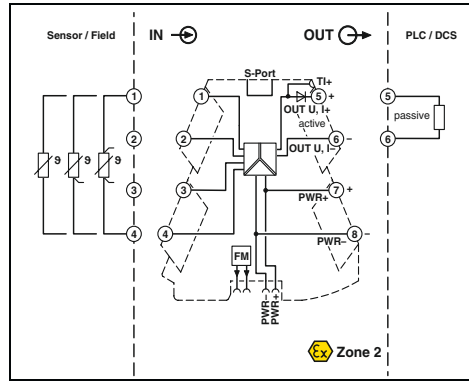
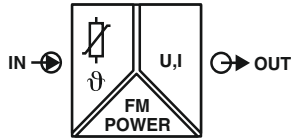

Universal temperature transducer for resistance thermometers



Housing width 6.2 mm

- Universally configurable, highly compact temperature transducer for electrical isolation, conversion, amplification, and filtering of resistance thermometer and remote resistance-type sensor signals
- For 2, 3 or 4-conductor sensors in accordance with IEC 751, JIS, GOST
- 2-conductor resistance measurement, up to 4,000 Ω
- Plug-in connection system
- Safe 3-way isolation
- Standard signal combinations configurable via DIP switches
- Freely-configurable with software or smartphone app
- Power supply and fault monitoring possible via DIN rail connector
- Status and error indicator LEDs

Notes:
The configuration software can be downloaded from the Internet: phoenixcontact.net/products .
Information on the programming adapters can be found on page 111
Information on MINI Analog Pro accessories can be found from page 107
To order a product with an order configuration, please enter the desired configuration by referring to the order key.

Input data	Input signal (can be configured using DIP switches) Temperature range
Measuring range span	Linear resistance measuring range
Output data	Output signal (configurable via DIP switch or freely via software)
Maximum output signal	No-load voltage Short-circuit current Load R_B Ripple
General data	Supply voltage range Current consumption Power consumption
Transmission error	
Temperature coefficient	Step response (0 - 99%)
Electrical isolation	EMC note
Conformance/approvals	Conformance ATEX UL, USA/Canada
DNV GL	

Technical data

Pt, Ni, Cu sensors : 2-, 3-, 4-conductor
-200°C ... 850°C (range depends on sensor type, range can be set freely via software or in increments from -150°C to 850°C via DIP switches)

≥20 K
0 Ω ... 4,000 Ω (minimum measuring span: 10% of the selected measuring range)

U output	I output
0 ... 5 V / 1 ... 5 V	0 ... 20 mA / 4 ... 20 mA

0 ... 10 V / 10 ... 0 V	20 ... 0 mA / 20 ... 4 mA
Approx. 12.3 V	24.6 mA <17.5 V

<31.5 mA	
≥10 kΩ	≤600 Ω (at 20 mA)
<10 mV _{rms}	<10 mV _{rms} (at 600 Ω)

9.6 V DC ... 30 V DC
32 mA (24 V DC)
≤850 mW (at I_{OUT} = 20 mA, 9.6 V DC, 600 Ω load)

0.1% * 350 K / set measuring range; 0.1% >350 K (Pt/Ni)
0.3% * 200 K / set measuring range; 0.3% >200 K (Cu)

0.01%/K
Typically 200 ms (2-conductor)
Typically 500 ms (3-conductor)
Typically 500 ms (4-conductor)
Reinforced insulation in accordance with IEC 61010-1
Class A product, see page 583

CE-compliant
Ex II 3 G Ex nA IIC T4 Gc X
UL 508 Listed
Class I, Div. 2, Groups A, B, C, D T6
Class I, Zone 2, Group IIC T6
C, EMC2

Ordering data

Type	Order No.	Pcs./Pkt.
MINI MCR-2-RTD-UI-PT	2902052	1
MINI MCR-2-RTD-UI	2902049	1
MINI MCR-2-RTD-UI-PT-C	2902051	1
MINI MCR-2-RTD-UI-C	2902048	1

Accessories

IFS-USB-PROG-ADAPTER	2811271	1
TWN4 MIFARE NFC USB ADAPTER	2909681	1
IFS-BT-PROG-ADAPTER	2905872	1

Description	
Temperature transducers for resistance thermometers	
Standard configuration	Push-in connection
Standard configuration	Screw connection
Order configuration	Push-in connection
Order configuration	Screw connection

Programming adapter for configuring modules with S-PORT interface
USB programming adapter for configuring modules with Windows software
Bluetooth programming adapter , with USB and S-PORT interface

MINI Analog Pro – Highly compact signal conditioners with plug-in connection technology

Order key for MINI MCR-2-RTD-UI(-PT)(-C) temperature transducers (standard configuration entered as example)

Order No.	Sensor type	Connection technology	Measuring unit	Measuring range		Output		
				Start	End	Output signal	Start	End
2902048	PT100	3	C	-50	150	I	4.0	20.0
2902048 ≙ MINI MCR-2-RTD-UI-C	PT100 ≙ Pt 100 IEC751 PT200 ≙ Pt 200 IEC751 PT500 ≙ Pt 500 IEC751 PT1000 ≙ Pt 1000 IEC751	2 ≙ 2-conductor 3 ≙ 3-conductor 4 ≙ 4-conductor	C ≙ °C F ≙ °F	Freely selectable between -200°C ... 850°C (measuring range limits depend on sensor type)	Freely selectable between -200°C ... 850°C (measuring range limits depend on sensor type)	I ≙ I U ≙ U	0.0 ≙ 0 mA I: freely selectable between 0.0 ... 21 mA U: freely selectable between 0.0 ... 10.5 V	20.0 ≙ 20 mA I: freely selectable between 0.0 ... 21 mA U: freely selectable between 0.0 ... 10.5 V
2902051 ≙ MINI MCR-2-RTD-UI-PT-C	PT100G ≙ Pt 100 GOST 6651-2009 (α = 0.00394) PT1000G ≙ Pt 1000 GOST 6651-2009 (α = 0.00394) PT100J ≙ Pt 100 JIS C1604/1997 PT1000J ≙ Pt 1000 JIS C1604/1997 Ni100 ≙ Ni 100 DIN 43760 Ni1000 ≙ Ni 1000 DIN 43760 Cu50 ≙ Cu 50 GOST 6651-2009 (α = 0.00428) Cu100 ≙ Cu 100 GOST 6651-2009 (α = 0.00428) Cu53 ≙ Cu 53 GOST 6651-2009 (α = 0.00426)							

Minimum measuring span 20 K

Output signal span at least 0.5 V / 1 mA
Increment 0.1 V / 0.1 mA

Failure information

Behavior in the event of an error

Open circuit

Short circuit

Measuring value over-range

Measured value under-range

Factory calibration certificate

NE43DO	0.0	0.0	0.0	0.0	None	
FD ≙ Freely definable	0.0 ≙ 0 mA I: freely selectable between 0.0 ... 21.5 mA U: freely selectable between 0.0 ... 11 V (signal type corresponds to selected output signal)	0.0 ≙ 0 mA I: freely selectable between 0.0 ... 21.5 mA U: freely selectable between 0.0 ... 11 V (signal type corresponds to selected output signal)	0.0 ≙ 0 mA I: freely selectable between 0.0 ... 21.5 mA U: freely selectable between 0.0 ... 11 V (signal type corresponds to selected output signal)	0.0 ≙ 0 mA I: freely selectable between 0.0 ... 21.5 mA U: freely selectable between 0.0 ... 11 V (signal type corresponds to selected output signal)	0.0 ≙ 0 mA I: freely selectable between 0.0 ... 21.5 mA U: freely selectable between 0.0 ... 11 V (signal type corresponds to selected output signal)	None ≙ no factory calibration certificate Yes ≙ certificate but no test data YesPlus ≙ certificate with test data
Note: Failure information in accordance with NE 43 can only be selected for 4 ... 20 mA output						
NE43UP ≙ NE 43 upsacle NE43DO ≙ NE 43 downscale NE430 ≙ NE 43 0 mA NE43UD ≙ NE 43 upsacle/ downscale	21.5 mA 3.5 mA 0 mA 3.5 mA	21.5 mA 3.5 mA 0 mA 3.5 mA	21.5 mA 3.5 mA 0 mA 3.5 mA	21.5 mA 3.5 mA 0 mA 21.5 mA	21.5 mA 3.5 mA 0 mA 21.5 mA	

Sensor types and measuring ranges for MINI MCR-2-RTD-UI(-PT)(-C) temperature transducers

Sensor type	Standard	Measuring range	Smallest measuring span	Adjustable using:
Pt 100	IEC 751 = GOST 6651-2009 (α = 0.00385)	-200°C ... +850°C	20 K	DIP switch
Pt 200	IEC 751 = GOST 6651-2009 (α = 0.00385)	-200°C ... +850°C	20 K	DIP switch
Pt 500	IEC 751 = GOST 6651-2009 (α = 0.00385)	-200°C ... +850°C	20 K	Software or smartphone app
Pt 1000	IEC 751 = GOST 6651-2009 (α = 0.00385)	-200°C ... +850°C	20 K	Software or smartphone app
Pt 100	GOST 6651-2009 (α = 0.00391)	-200°C ... +850°C	20 K	Software or smartphone app
Pt 1000	GOST 6651-2009 (α = 0.00391)	-200°C ... +850°C	20 K	Software or smartphone app
Pt 100	JIS C1604-1997	-200°C ... +850°C	20 K	Software or smartphone app
Pt 1000	JIS C1604-1997	-200°C ... +850°C	20 K	Software or smartphone app
Ni100	DIN 43760	-60°C ... +250°C	20 K	Software or smartphone app
Ni 1000	DIN 43760	-60°C ... +250°C	20 K	Software or smartphone app
Cu50	GOST 6651-2009 (α = 0.0428)	-180°C ... +200°C	20 K	Software or smartphone app
Cu100	GOST 6651-2009 (α = 0.0428)	-180°C ... +200°C	20 K	Software or smartphone app
Cu53	GOST 6651-2009 (α = 0.0426)	-50°C ... +180°C	20 K	Software or smartphone app
Customer-specific characteristic curves		-200°C ... +850°C	20 K	Software or smartphone app

Temperature
Temperature transducers
for thermocouples

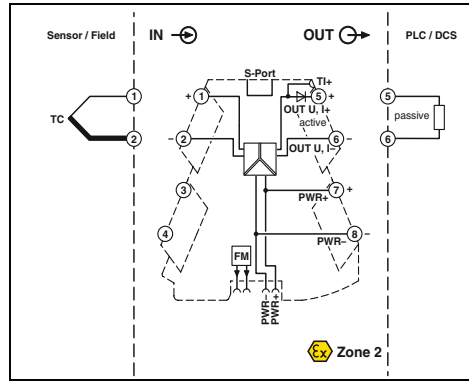
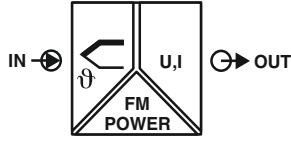

Universal temperature transducer for thermocouples



Housing width 6.2 mm

- Universally configurable, highly compact temperature transducer for electrical isolation, conversion, amplification, and filtering of thermocouple signals
- Voltage measurement from ±0 ... 15 mV to ±0 ... 500 mV, fully adjustable
- For thermocouples in accordance with IEC 584 and GOST
- Internal cold junction compensation
- Plug-in connection system
- Safe 3-way isolation
- Standard signal combinations configurable via DIP switches
- Freely-configurable with software or smartphone app
- Power supply and fault monitoring possible via DIN rail connector
- Status and error indicator LEDs

Notes:
The configuration software can be downloaded from the Internet: phoenixcontact.net/products .
Information on the programming adapters can be found on page 111
Information on MINI Analog Pro accessories can be found from page 107
To order a product with an order configuration, please enter the desired configuration by referring to the order key.

Input data	Input signal (can be configured using DIP switches) Temperature range
Measuring range span	
Output data	Output signal (configurable via DIP switch or freely via software)
Maximum output signal	No-load voltage Short-circuit current Load R _B Ripple
General data	Supply voltage range Current consumption Power consumption
Transmission error	
Cold junction errors	Temperature coefficient Step response (0 - 99%) Electrical isolation EMC note
Conformance/approvals	Conformance ATEX UL, USA/Canada
DNV GL	

Technical data

B, C, E, J, K, N, R, S, T, L, U, A-1, A-2, A-3, M, L
-250°C ... 2500°C (range depends on sensor type, range can be set freely via software or in increments from -150°C to 1350°C via DIP switches)

min. 50 K	
U output	I output
0 ... 5 V / 1 ... 5 V	0 ... 20 mA / 4 ... 20 mA
0 ... 10 V / 10 ... 0 V	20 ... 0 mA / 20 ... 4 mA
Approx. 12.3 V	24.6 mA
<31.5 mA	<17.5 V
≥10 kΩ	≤600 Ω (at 20 mA)
<10 mV _{rms}	<10 mV _{rms} (at 600 Ω)

9.6 V DC ... 30 V DC
32.7 mA (24 V DC)
≤850 mW (at I_{OUT} = 20 mA, 9.6 V DC, 600 Ω load)

0.1% * 600 K / set measuring range;
0.1% >600 K (C, E, J, K, N, T, L, U, M Gost, L Gost)
0.2% * 600 K / set measuring range;
0.2% >600 K (B, R, S, A1, A2, A3)
0.2% * 600 K / set measuring range;
0.2% >600 K (E, J, K, N, T, L, U, M Gost, L Gost); Highspeed Mode
0.4% * 600 K / set measuring range;
0.4% >600 K (B, R, S, A1, A2, A3); Highspeed Mode

- (typically 2 K (2 K + (0.2 K * ΔT)))
≤0.01%/K
Typically 400 ms (highspeed Mode: typically 150 ms)
Reinforced insulation in accordance with IEC 61010-1
Class A product, see page 583

CE-compliant
Ex II 3 G Ex nA IIC T4 Gc X
UL 508 Listed
Class I, Div. 2, Groups A, B, C, D T6
Class I, Zone 2, Group IIC T6
C, EMC2

Ordering data

Description	
Temperature transducers for thermocouples	
Standard configuration	Push-in connection
Standard configuration	Screw connection
Order configuration	Push-in connection
Order configuration	Screw connection

Type	Order No.	Pcs./Pkt.
MINI MCR-2-TC-UI-PT	2905249	1
MINI MCR-2-TC-UI	2902055	1
MINI MCR-2-TC-UI-PT-C	2905248	1
MINI MCR-2-TC-UI-C	2902053	1

Programming adapter for configuring modules with S-PORT interface	
USB programming adapter for configuring modules with Windows software	
Bluetooth programming adapter , with USB and S-PORT interface	

Accessories		
IFS-USB-PROG-ADAPTER	2811271	1
TWN4 MIFARE NFC USB ADAPTER	2909681	1
IFS-BT-PROG-ADAPTER	2905872	1

MINI Analog Pro – Highly compact signal conditioners with plug-in connection technology

Order key for MINI MCR-2-TC-UI(-PT)(-C) temperature transducers (standard configuration entered as an example)

Order No.	Sensor type	Cold junction error compensation	Measuring unit	Measuring range		Output	Output signal		...
				Start	End		Start	End	
2902053	J	1	C	-200	1200	I	4.0	20.0	...
2902053 ≙ MINI MCR-2-TC-UI-C	B ≙ B IEC 584-1 (Pt30Rh-Pt6Rh) E ≙ E IEC 584-1 (NiCr-CuNi) J ≙ J IEC 584-1 (Fe-CuNi) K ≙ K IEC 584-1 (NiCr-Ni) N ≙ N IEC 584-1 (NiCrSi-NiSi) R ≙ R IEC 584-1 (Pt13Rh-Pt) S ≙ S IEC 584-1 (Pt10Rh-Pt) T ≙ T IEC 584-1 (Cu-CuNi) L ≙ L DIN 43760 (Fe-CuNi) U ≙ U DIN 43760 (Cu-CuNi) A1G ≙ A-1 GOST 8.585-2001 A2G ≙ A-2 GOST 8.585-2001 A3G ≙ A-3 GOST 8.585-2001 MG ≙ M GOST 8.585-2001 LG ≙ L GOST 8.585-2001	0 ≙ OFF 1 ≙ AN	C ≙ °C F ≙ °F	Freely selectable between -250°C ... 2500°C (measuring range limits depend on sensor type)	Freely selectable between -250°C ... 2500°C (measuring range limits depend on sensor type)	I ≙ I U ≙ U	0.0 ≙ 0 mA I: freely selectable between 0.0 ... 21 mA U: freely selectable between 0.0 ... 10.5 V	20.0 ≙ 20 mA I: freely selectable between 0.0 ... 21 mA U: freely selectable between 0.0 ... 10.5 V	...

Minimum measuring span 50 K

Output signal span at least 0.5 V / 1 mA
Increment 0.1 V / 0.1 mA

Failure information

Behavior in the event of an error

Open circuit

Measuring value over-range

Measured value under-range

Factory calibration certificate

...	NE43DO	0.0	0.0	0.0	None
FD ≙ Freely definable	0.0 ≙ 0 mA I: freely selectable between 0.0 ... 21.5 mA U: freely selectable between 0.0 ... 11 V (signal type corresponds to selected output signal)	0.0 ≙ 0 mA I: freely selectable between 0.0 ... 21.5 mA U: freely selectable between 0.0 ... 11 V (signal type corresponds to selected output signal)	0.0 ≙ 0 mA I: freely selectable between 0.0 ... 21.5 mA U: freely selectable between 0.0 ... 11 V (signal type corresponds to selected output signal)	0.0 ≙ 0 mA I: freely selectable between 0.0 ... 21.5 mA U: freely selectable between 0.0 ... 11 V (signal type corresponds to selected output signal)	None ≙ no factory calibration certificate Yes ≙ certificate but no test data YesPlus ≙ certificate with test data
Note: Failure information in accordance with NE 43 can only be selected for 4 ... 20 mA output					
NE43UP ≙ NE 43 upscale NE43DO ≙ NE 43 downscale NE430 ≙ NE 43 0 mA NE43UD ≙ NE 43 upscale/downscale	21.5 mA 3.5 mA 0 mA 3.5 mA	21.5 mA 3.5 mA 0 mA 21.5 mA	21.5 mA 3.5 mA 0 mA 21.5 mA	21.5 mA 3.5 mA 0 mA 21.5 mA	

Sensor types and measuring ranges for MINI MCR-2-TC-UI(-PT)(-C) temperature transducers

Sensor type	Standard	Measuring range	Smallest measuring span	Adjustable using:
B	IEC 584-1	+500°C ... +1,820°C	50 K	Software or smartphone app
E	IEC 584-1	-230°C ... +1,000°C	50 K	Software or smartphone app
J	IEC 584-1	-210°C ... +1,200°C	50 K	DIP switch
K	IEC 584-1	-250°C ... +1,372°C	50 K	DIP switch
N	IEC 584-1	-200°C ... +1,300°C	50 K	Software or smartphone app
R	IEC 584-1	-50°C ... +1,768°C	50 K	Software or smartphone app
S	IEC 584-1	-50°C ... +1,768°C	50 K	Software or smartphone app
T	IEC 584-1	-200°C ... +400°C	50 K	Software or smartphone app
L	DIN 43710	-200°C ... +900°C	50 K	Software or smartphone app
U	DIN 43710	-200°C ... +600°C	50 K	Software or smartphone app
A-1	GOST 8.585	0°C ... +2,500°C	50 K	Software or smartphone app
A-2	GOST 8.585	0°C ... +1,800°C	50 K	Software or smartphone app
A-3	GOST 8.585	0°C ... +1,800°C	50 K	Software or smartphone app
M	GOST 8.585	-200°C ... +100°C	50 K	Software or smartphone app
L	GOST 8.585	-200°C ... +800°C	50 K	Software or smartphone app
Customer-specific characteristic curves		-250°C ... +2,500°C	50 K	Software or smartphone app

Frequency
Universal frequency transducers

new

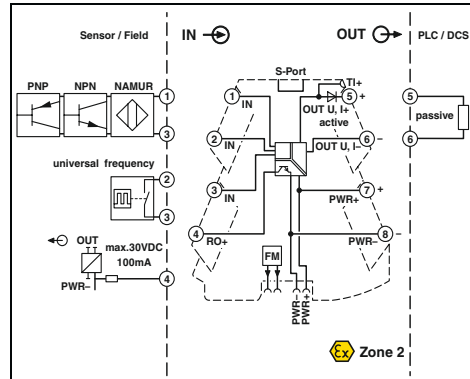
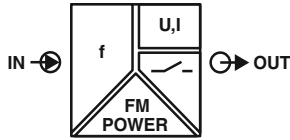

Configurable,
universal frequency or PWM input



Housing width 6.2 mm

- Universally configurable, highly compact 3-way isolated frequency transducer with inverting transistor switching output
- Suitable for the connection of NAMUR proximity sensors (IEC 60947-5-6 and EN 50227) as well as for sensors with NPN and PNP outputs that generate a frequency signal
- For electrical isolation, conversion, amplification, and filtering of frequency and PWM signals
- Frequency signals in the range from 0.002 to 200 kHz and PWM signals up to 1 kHz
- Supports fault monitoring
- Plug-in connection system
- Safe 3-way isolation
- Standard behavior can be configured via DIP switches
- Freely configurable via software or smartphone app
- Power supply and fault monitoring possible via DIN rail connector
- Status and error indicator LEDs

Notes:
The configuration software can be downloaded from the Internet: phoenixcontact.net/products.
Information on the programming adapters can be found on page 111

Input data
Input sources
Frequency measuring range
Maximum input signal
PWM (range)
Measuring range span
Output data
Output signal
Maximum output signal
Load R_B
Ripple
Switching output
Relay output
Max. switching voltage
Maximum switching current
Minimum switching current
General data
Supply voltage range
Current consumption
Power consumption
Maximum transmission error
Temperature coefficient
Step response (0 - 99%)
Electrical isolation
EMC note
Conformance/approvals
Conformance
ATEX
UL, USA/Canada
DNV GL

Technical data

NAMUR initiators	
NPN/PNP transistor outputs	
Floating contact (dry contact)	
Frequency generator	
Incremental encoder (speed only)	
HTL encoders	
TTL rotary transducer	
S0 signal	
0.002 Hz ... 200 kHz	
30 V (incl. DC voltage)	
0.002 Hz ... 60 Hz (Duty cycle 2 ... 98%)	
60 Hz ... 300 Hz (Duty cycle 5 ... 95%)	
300 Hz ... 600 Hz (Duty cycle 10 ... 90%)	
600 Hz ... 1,000 Hz (Duty cycle 20 ... 80%)	
≥ 2 V	
U output	I output
0 ... 10 V / 2 ... 10 V	0 ... 20 mA / 4 ... 20 mA
0 ... 5 V / 1 ... 5 V	0 ... 10 mA / 2 ... 10 mA
Approx. 12.3 V	24.6 mA
≥ 10 kΩ	≤ 600 Ω (at 20 mA)
< 20 mV _{pp} (at 600 Hz)	< 20 mV _{pp} (at 600 Ω)
1 N/O contact	
30 V DC	
100 mA (30 V)	
100 μA	
9.6 V DC ... 30 V DC	
32 mA (24 V DC)	
63 mA (12 V DC)	
≤ 1 W (at I _{OUT} = 20 mA, 9.6 V DC, 600 Ω load)	
0.1% (Frequency)	
1% (PWM signal)	
0.01%/K, typically 0.01%/K	
< 35 ms (f > 500 Hz)	
Reinforced insulation in accordance with IEC 61010-1	
Class A product, see page 583	
CE-compliant	
Ex II 3 G Ex nA IIC T4 Gc X	
UL 508 Listed	
Class I, Div. 2, Groups A, B, C, D T5	
Class I, Zone 2, Group IIC T5	
B, B, A, A	

Ordering data

Type	Order No.	Pcs./Pkt.
MINI MCR-2-F-UI-PT	2902058	1
MINI MCR-2-F-UI	2902056	1
MINI MCR-2-F-UI-PT-C	2902059	1
MINI MCR-2-F-UI-C	2902057	1

Accessories

IFS-USB-PROG-ADAPTER	2811271	1
TWN4 MIFARE NFC USB ADAPTER	2909681	1
IFS-BT-PROG-ADAPTER	2905872	1
MINI MCR-2-SPS-24-15-PT	1033201	1
MINI MCR-2-SPS-24-15	1033202	1

Description	
MCR frequency transducers	
Standard configuration	Push-in connection
Standard configuration	Screw connection
Order configuration	Push-in connection
Order configuration	Screw connection
Programming adapter for configuring modules with S-PORT interface	
USB programming adapter for configuring modules with Windows software	
Bluetooth programming adapter , with USB and S-PORT interface	
Constant voltage source	
with Push-in connection	
with screw connection	

MINI Analog Pro – Highly compact signal conditioners with plug-in connection technology

Order key for MINI MCR-2-F-UI(-PT)(-C) 3-way signal conditioners (standard configuration entered as an example)

Order No.	Input		Sensor		Frequency signal		PWM signal		Output signal	
	Input signal		Low voltage level	High voltage level	Start	End	Start	End		
2902057	f	NAMUR	0	30	0.002	200,000.000	2	98	I	...
2902057 ≙ MINI MCR-2-F-UI-C	f ≙ f PWM ≙ PWM	NAMUR ≙ NAMUR NPN ≙ NPN PNP ≙ PNP Frequency ≙ General frequency input	U: freely selectable between 0.0 ... 28 V The minimum measuring span must be 2 V.	U: freely selectable between 2.0 ... 30 V The minimum measuring span must be 2 V.	0.002 ≙ 0.002 Hz f: ≙ freely selectable between 0.002 ... 133,333.33 Hz	200,000.000 ≙ 200,000.000 Hz f: ≙ freely selectable between 0.003 ... 200,000 Hz	PWM: freely selectable between 2 ... 88%	PWM: freely selectable between 12 ... 98%	I ≙ I U ≙ U	

Measuring range span at least 10%/see below*
Increment 1% / 0.001 Hz

Output signal span at least 0.5 V / 1 mA
Increment 0.1 V / 0.1 mA

Output		Switching output		Factory calibration certificate		
Start	End	Switching function		Low switching point (SPL)	High switching point (SPH)	
4.0	20.0	0		0.0	0.0	NONE
0 ≙ 0 mA I: freely selectable between 0.0 ... 20 mA U: freely selectable between 0.0 ... 10 V	0 ≙ 0 mA I: freely selectable between 0.0 ... 21 mA U: freely selectable between 0.0 ... 10.5 V	0 ≙ L 1 ≙ H 2 ≙ L -->SPH -->H 3 ≙ H -->SPH -->L 4 ≙ L -->SPH -->H -->SPH -->L 5 ≙ H -->SPH -->L -->SPH -->H 6 ≙ L -->SPL -->H -->SPH -->L 7 ≙ H -->SPL -->L -->SPH -->H		f: ≙ freely selectable between 0.002 ... 133,333.33 Hz PWM: freely selectable between 2 ... 88% Only values for switching functions 4, 5, 6, 7 can be set	f: ≙ freely selectable between 0.003 ... 200,000 Hz PWM: freely selectable between 12 ... 98% Only values for switching functions 2, 3, 4, 5, 6, 7 can be set	NONE YES YES PLUS
				Values depend on the input range selected	Values depend on the input range selected	

Note:
L = Low (relay off)
H = High (relay on)
SPL = Setpoint Low
SPH = Setpoint High

*** Note:**
The minimum separation between the two values depends on the frequency range in which they are located.
If the start value is being set, then the maximum possible value that can be set depends on the already set final value.
If the final value is being set, then the smallest possible value that can be set depends on the already set start value.

If the start value is being set:

Final Value	Maximum possible start value that can be set
≤ 10.1 Hz	Final value 1.01
>10.1 Hz ... 110 Hz	Final value 1.1
>110 Hz ... 240 Hz	Final value 1.2
>240 Hz ... 364 Hz	Final value 1.3
>364 Hz ... 490 Hz	Final value 1.4
>490 Hz	Final value 1.5

If the final value is being set:

Start value	Smallest possible final value that can be set
≤ 10 Hz	Start value 1.01
>10 Hz ... 100 Hz	Start value 1.1
>100 Hz ... 200 Hz	Start value 1.2
>200 Hz ... 280 Hz	Start value 1.3
>280 Hz ... 350 Hz	Start value 1.4
>350 Hz	Start value 1.5

Frequency
Analog frequency transducers

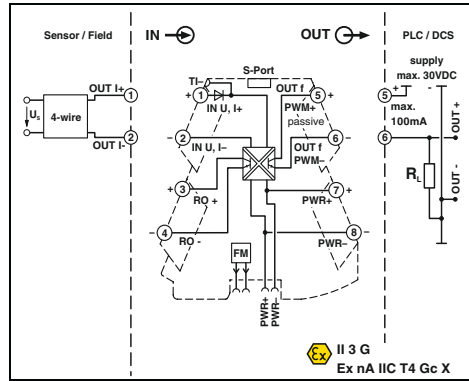
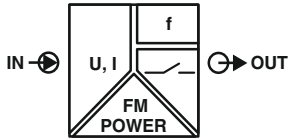

Configurable, frequency, PWM or switching output



Housing width 6.2 mm

- Universally configurable highly-compact analog-to-frequency measuring transducer for electrical isolation, amplification, conversion and filtering of analog standard signals to frequencies or PWM signals
- Plug-in connection system
- Safe 3-way isolation
- Additional switching output
- Frequency output can be used as second switching output
- Standard signal combinations configurable via DIP switches
- Freely-configurable with software or smartphone app
- Power supply and fault monitoring possible via DIN rail connector
- Status and error indicator LEDs

Notes:
The configuration software can be downloaded from the Internet: phoenixcontact.net/products .
Information on the programming adapters can be found on page 111
Information on MINI Analog Pro accessories can be found from page 107
To order a product with an order configuration, enter the required configuration by referring to the adjacent order key.

Input data
Input signal (configurable via DIP switch or freely via software)
Maximum input signal
Input resistance
Output data
Output signal (configurable via DIP switch or freely via software)
Minimum load
Load current maximum
Maximum switching voltage
Overrange/underrange
General data
Supply voltage range
Nominal supply voltage
Current consumption
Power consumption
Transmission error, maximum
Temperature coefficient
Step response (0 - 99%)
Electrical isolation
Degree of protection
EMC note
Conformance/approvals
Conformance
ATEX
UL, USA/Canada
DNV GL

Technical data	
U input	I input
0 V ... 10 V	0 mA ... 20 mA
2 V ... 10 V	4 mA ... 20 mA
0 V ... 5 V	0 mA ... 10 mA
1 V ... 5 V	2 mA ... 10 mA
10 V ... 0 V	20 mA ... 0 mA
10 V ... 2 V	20 mA ... 4 mA
5 V ... 0 V	10 mA ... 0 mA
5 V ... 1 V	10 mA ... 2 mA
0 V ... 12 V	0 mA ... 24 mA
12 V	24 mA
>120 kΩ	Approx. 50 Ω (+ 0.7 V for test diode)
Frequency output	PWM output
0 Hz ... 10 kHz / 0 Hz ... 5 kHz	15.6 kHz (10 bit) / 1.9 kHz (10 bit)
0 Hz ... 2.5 kHz / 0 Hz ... 1 kHz	3.9 kHz (12 bit) / 488 Hz (12 bit)
0 Hz ... 500 Hz / 0 Hz ... 250 Hz	977 Hz (14 bit) / 122 Hz (14 bit)
0 Hz ... 100 Hz / 0 Hz ... 50 Hz	50 Hz (15 Bit) / 244 Hz (16 bit)
4 mA ≤ (U _L / R _L) ≤ 100 mA	12 mA ≤ (U _L / R _L) ≤ 100 mA
100 mA	
30 V	
Can be set (via software)	
9.6 V DC ... 30 V DC	
24 V DC	
27 mA (12 V DC)	
13.5 mA (24 V DC)	
≤350 mW (9.6 V DC)	
≤0.1% (>7 kHz ≤0.2%)	
<0.01%/K, typically 0.01%/K	
120 ms (15 Hz sample rate)	
Further values can be set via software	
Reinforced insulation in accordance with IEC 61010-1	
IP20	
Class A product, see page 583	
CE-compliant	
Ex II 3 G Ex nA IIC T4 Gc X	
UL 508 Listed	
Class I, Div. 2, Groups A, B, C, D T6	
Class I, Zone 2, Group IIC T6	
B, B, A, A	

Description
Analog frequency converter with limit value function
Standard configuration Push-in connection
Standard configuration Screw connection
Order configuration Push-in connection
Order configuration Screw connection

Ordering data		
Type	Order No.	Pcs./Pkt.
MINI MCR-2-UI-FRO-PT	2902032	1
MINI MCR-2-UI-FRO	2902031	1
MINI MCR-2-UI-FRO-PT-C	2906202	1
MINI MCR-2-UI-FRO-C	2906201	1

Programming adapter for configuring modules with S-PORT interface
USB programming adapter for configuring modules with Windows software
Bluetooth programming adapter , with USB and S-PORT interface

Accessories		
Type	Order No.	Pcs./Pkt.
IFS-USB-PROG-ADAPTER	2811271	1
TWN4 MIFARE NFC USB ADAPTER	2909681	1
IFS-BT-PROG-ADAPTER	2905872	1

MINI Analog Pro – Highly compact signal conditioners with plug-in connection technology

Order key for MINI MCR-2-UI-FRO(-PT)(-C) analog frequency measuring transducers (standard configuration entered as example)

Order No.	Input		Output		Carrier frequency		Measuring range limit	
	Input signal	Start	End	Output signal	Start	End	Start	End
2906201	I	0.0	20.0	I	0	0	1,000	15
2906201 ≙ MINI MCR-2-UI-FRO-C	I ≙ I U ≙ U	0.0 ≙ 0 mA I: freely selectable between 0.0 ... 24 mA U: freely selectable between 0.0 ... 24 mA	20.0 ≙ 20 mA I: freely selectable between 0.0 ... 24 mA U: freely selectable between 0.0 ... 12 V	f ≙ f PWM ≙ PWM	0 ≙ at frequency output 15.6 k ≙ 15.6 kHz 15.6 kHz (10 bits) 1.9 kHz (10 bits) 7.8 kHz (11 bits) 977 Hz (11 bits) 3.9 kHz (12 bits) 488 Hz (12 bits) 1.9 kHz (13 bits) 244 Hz (13 bits) 977 Hz (14 bits) 122 Hz (14 bits) 488 Hz (15 bits) 61 Hz (15 bits) 244 Hz (16 bits) 31 Hz (16 bits)	0 ≙ 0 Hz f: freely selectable between 0 ... 10 kHz D: freely selectable between 0.0 ... 100%	10,000 ≙ 10 kHz f: freely selectable between 0 ... 10 kHz D: freely selectable between 0.0 ... 100%	0 ≙ off 1 ≙ on

Measuring range span at least 0.5 V / 1 mA
Increment 0.1 V / 0.1 mA

Output signal span at least 10 Hz / 1%
Increment 1 Hz / 0.1%

Cut-off frequency	Failure information Open circuit / short circuit	Behavior in the event of an error	Measuring value over-range	Measured value under-range	Factory calibration certificate
15	0	FD	0	0	NONE
15 Hz ≙ 15 Hz 60 Hz ≙ 60 Hz 240 Hz ≙ 240 Hz	0 ≙ 0 Hz f: freely selectable between 0 ... 11 kHz D: freely selectable between 0.0 and 100% (free definition only for unlimited output) (signal type corresponds to selected output signal)	FD ≙ Freely definable Failure information only adjustable for unlimited output	0 ≙ 0 Hz f: freely selectable between 0 ... 11 kHz D: freely selectable between 0.0 and 100% (free definition only for unlimited output) (signal type corresponds to selected output signal)	0 ≙ 0 Hz f: freely selectable between 0 ... 11 kHz D: freely selectable between 0.0 and 100% (free definition only for unlimited output) (signal type corresponds to selected output signal)	NONE ≙ no factory calibration certificate Yes ≙ certificate but no test data YesPlus ≙ certificate with test data

Potentiometers

Potentiometer transducers

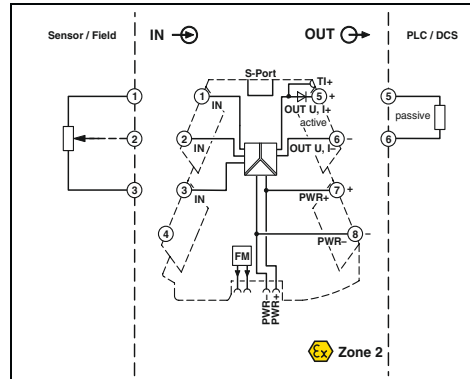
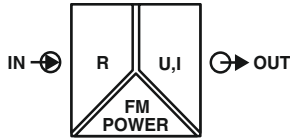

Potentiometer transducer, configurable



Housing width 6.2 mm

- Universally configurable, highly compact potentiometer transducer for electrical isolation, conversion, amplification, and filtering of potentiometer signals
- For potentiometers from 100 Ω to 100 kΩ
- Automatic potentiometer detection without manual adjustment
- Plug-in connection system
- Safe 3-way isolation
- Standard signal combinations configurable via DIP switches
- Freely-configurable with software or smartphone app
- Power supply and fault monitoring possible via DIN rail connector
- Status and error indicator LEDs

Notes:
The configuration software can be downloaded from the Internet: phoenixcontact.net/products .
Information on the programming adapters can be found on page 111
Information on MINI Analog Pro accessories can be found from page 107
To order a product with an order configuration, please enter the desired configuration by referring to the order key.

Input data	Potentiometer	100 Ω ... 100 kΩ
Output data	Output signal (configurable via DIP switch or freely via software)	U output 1 ... 5 V / 10 ... 0 V
	Maximum output signal	0 ... 5 V / 0 ... 10 V
	No-load voltage	Approx. 12.3 V
	Short-circuit current	<31.5 mA
	Load R _B	≥10 kΩ
	Ripple	<20 mV _{PP} (at 10 kΩ)
	Behavior in the event of a sensor error	configurable
General data	Supply voltage range	9.6 V DC ... 30 V DC
	Nominal supply voltage	24 V DC
	Current consumption	33 mA (24 V DC)
	Power consumption	≤850 mW (at I _{OUT} = 20 mA, 9.6 V DC, 600 Ω load)
	Maximum transmission error	<0.1% (R <240 Ω = <0.2%)
	Temperature coefficient	0.01%/K, typically 0.01%/K
	Step response (0 - 99%)	<60 ms
	Electrical isolation	Reinforced insulation in accordance with IEC 61010-1
	Degree of protection	IP20
	EMC note	Class A product, see page 583
Conformance/approvals	Conformance	CE-compliant
	ATEX	Ex II 3 G Ex nA IIC T4 Gc X
	UL, USA/Canada	UL 508 Listed Class I, Div. 2, Groups A, B, C, D T5 Class I, Zone 2, Group IIC T5 C, EMC2
	DNV GL	

Technical data

	I output	0 ... 20 mA / 4 ... 20 mA
	20 ... 0 mA / 20 ... 4 mA	24.6 mA
	<17.5 V	
	≤600 Ω (at 20 mA)	
	<20 mV _{PP}	
	configurable	
	9.6 V DC ... 30 V DC	
	24 V DC	
	33 mA (24 V DC)	
	≤850 mW (at I _{OUT} = 20 mA, 9.6 V DC, 600 Ω load)	
	<0.1% (R <240 Ω = <0.2%)	
	0.01%/K, typically 0.01%/K	
	<60 ms	
	Reinforced insulation in accordance with IEC 61010-1	
	IP20	
	Class A product, see page 583	
	CE-compliant	
	Ex II 3 G Ex nA IIC T4 Gc X	
	UL 508 Listed	
	Class I, Div. 2, Groups A, B, C, D T5	
	Class I, Zone 2, Group IIC T5	
	C, EMC2	

Ordering data

Type	Order No.	Pcs./Pkt.
MINI MCR-2-POT-UI-PT	2902017	1
MINI MCR-2-POT-UI	2902016	1
MINI MCR-2-POT-UI-PT-C	2905006	1
MINI MCR-2-POT-UI-C	2905005	1

Accessories

IFS-USB-PROG-ADAPTER	2811271	1
TWN4 MIFARE NFC USB ADAPTER	2909681	1
IFS-BT-PROG-ADAPTER	2905872	1

Description	
Potentiometer transducer	
Standard configuration	Push-in connection
Standard configuration	Screw connection
Order configuration	Push-in connection
Order configuration	Screw connection

Programming adapter for configuring modules with S-PORT interface	
USB programming adapter for configuring modules with Windows software	
Bluetooth programming adapter , with USB and S-PORT interface	

MINI Analog Pro – Highly compact signal conditioners with plug-in connection technology

Order key for MINI MCR-2-POT-UI(-PT)(-C) potentiometer measuring transducers (standard configuration entered as an example)

Order No.	Automatic potentiometer detection	Output			Sliding mean value	Open circuit detection
		Output signal	Start	End		
2905005	AUTO	I	4.0	20.0	1	ON / ...
2905005 ≙ MINI MCR-2-POT-UI-C	AUTO ≙ ON OFF ≙ OFF	I ≙ I U ≙ U	0.0 ≙ 0 mA I: freely selectable between 0.0 ... 21 mA U: freely selectable between 0.0 ... 10.5 V	20.0 ≙ 20 mA I: freely selectable between 0.0 ... 21 mA U: freely selectable between 0.0 ... 10.5 V	1 2 3 4 5 6 7 8 9 10	ON ≙ ON OFF ≙ OFF
2905006 ≙ MINI MCR-2-POT-UI-PT-C						

Output signal span at least 0.5 V / 1 mA
Increment 0.1 V / 0.1 mA

Failure information

Behavior in the event of an error

Open circuit slider

Input open (no potentiometer connected)

Measuring value over-range

Measured value under-range

...	NE43DO	0.0	0.0	0.0	0.0
FD ≙ Freely definable	0.0 ≙ 0 mA I: freely selectable between 0.0 ... 21.5 mA U: freely selectable between 0.0 ... 11 V (only if open circuit detection is on) (signal type corresponds to selected output signal)	0.0 ≙ 0 mA I: freely selectable between 0.0 ... 21.5 mA U: freely selectable between 0.0 ... 11 V (signal type corresponds to selected output signal)	0.0 ≙ 0 mA I: freely selectable between 0.0 ... 21.5 mA U: freely selectable between 0.0 ... 11 V (signal type corresponds to selected output signal)	0.0 ≙ 0 mA I: freely selectable between 0.0 ... 21.5 mA U: freely selectable between 0.0 ... 11 V (signal type corresponds to selected output signal)	0.0 ≙ 0 mA I: freely selectable between 0.0 ... 21.5 mA U: freely selectable between 0.0 ... 11 V (signal type corresponds to selected output signal)
Note: Failure information in accordance with NE 43 can only be selected for 4 ... 20 mA output					
NE43UP ≙ NE 43 upscale	21.5 mA	21.5 mA	21.5 mA	21.5 mA	21.5 mA
NE43DO ≙ NE 43 downscale	3.5 mA	3.5 mA	3.5 mA	3.5 mA	3.5 mA
NE430 ≙ NE 43 0 mA	0 mA	0 mA	0 mA	0 mA	0 mA
NE43UD ≙ NE 43 upscale/downscale	3.5 mA	3.5 mA	21.5 mA	21.5 mA	21.5 mA

Digital IN
Signal conditioners

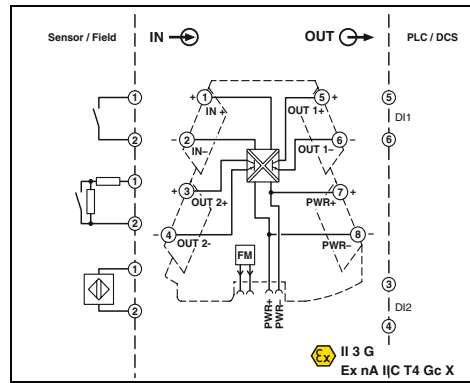
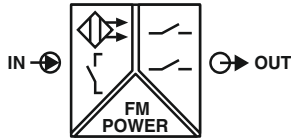

Configurable, for NAMUR sensors and floating contacts



Housing width 6.2 mm

- Highly compact signal conditioners for electrical isolation, amplification, and duplication of proximity sensor signals
- For proximity sensors in accordance with IEC 60947-5-6 and EN 50227
- Floating contacts and contacts with resistance circuit can be connected
- Plug-in connection system
- Input and output signals can be configured via DIP switches
- Transistor switching contacts on the output
- Second output can be used as a doubler or error signaling output
- Safe 3-way isolation
- Switchover between operating current and quiescent current (inverted switching behavior)
- Power supply and fault monitoring possible via DIN rail connector
- Status LEDs

Notes:
Information on MINI Analog Pro accessories can be found from page 107

Input data
Input signal
Control circuit
No-load voltage
Switching points (in accordance with IEC 60947-5-6)
Line error detection
Switching output
Transistor output
Max. switching voltage
Max. switching current
Switching frequency
General data
Supply voltage range
Nominal supply voltage
Current consumption
Power consumption
Electrical isolation
Degree of protection
EMC note
Conformance/approvals
Conformance
ATEX
UL, USA/Canada
DNV GL

Technical data

NAMUR proximity sensors (EN 60947-5-6)
open circuit switch contacts
Switch contacts with resistance circuit

8.2 V DC ±10%
<1.2 mA (blocking)
>2.1 mA (conductive)
>6 mA (in the event of a short-circuit)
<0.35 mA (with wire break)

N/O contact behavior 2x
30 V DC
50 mA
5 kHz

9.6 V DC ... 30 V DC
24 V DC
18 mA (24 V DC)
35 mA (12 V DC)
450 mW (9.6 V DC)
Reinforced insulation in accordance with IEC 61010-1
IP20
Class A product, see page 583

CE-compliant
Ex II 3 G Ex nA IIC T4 Gc X
UL 508 Listed
Class I, Div. 2, Groups A, B, C, D T6
Class I, Zone 2, Group IIC T6
B, B, A, A

Ordering data

Description	Type	Order No.	Pcs./Pkt.
NAMUR signal conditioner	Push-in connection	MINI MCR-2-NAM-2RO-PT	2902005 1
	Screw connection	MINI MCR-2-NAM-2RO	2902004 1



Limit values, threshold value switches

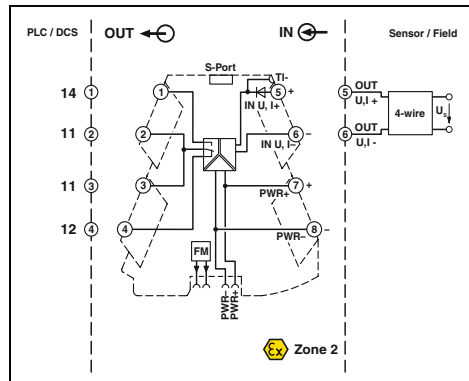
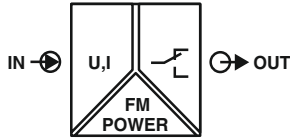

Configurable, with relay PDT output



Housing width 6.2 mm

- Universally configurable highly-compact threshold value switch for switching analog limit values
- Plug-in connection system
- Safe 3-way isolation
- Standard switching behavior can be configured via DIP switches
- Freely-configurable with software or smartphone app
- PDT relay at output
- Limiting continuous current up to 6 A
- Power supply and fault monitoring possible via DIN rail connector
- Status and error indicator LEDs

Notes:
The configuration software can be downloaded from the Internet: phoenixcontact.net/products .
Information on the programming adapters can be found on page 111
Information on MINI Analog Pro accessories can be found from page 107

Input data
Input signal (configurable using the DIP switch)
Maximum input signal
Input resistance
Specification of the switching point
Switching output
Relay output
Contact material
Max. switching voltage
Limiting continuous current
Hysteresis (configurable using the DIP switch)
Setting range of the response delay (configurable using the DIP switch)
General data
Supply voltage range
Nominal supply voltage
Current consumption
Power consumption
Maximum transmission error
Temperature coefficient
Step response (0 - 99%)
Electrical isolation
Degree of protection
Conformance/approvals
Conformance
ATEX
UL, USA/Canada
DNV GL

Technical data	
U input	I input
0 ... 10 V / 0 ... 12 V	0 ... 20 mA / 0 ... 24 mA
12 V	24 mA
>120 kΩ	Approx. 50 Ω (+ 0.7 V for test diode)
Can be set via software or in steps via DIP switches	
1 PDT	
AgSnO ₂ , hard gold-plated	
250 V AC	
6 A	
Can be set freely via software	
0 s ... 10 s (can be set freely via software)	
9.6 V DC ... 30 V DC	
24 V DC	
40 mA (12 V DC)	
20 mA (24 V DC)	
≤0.5 W	
0.1% (of final value)	
0.01%/K	
Typically 140 ms (can be set via software)	
Reinforced insulation in accordance with IEC 61010-1	
IP20	
CE-compliant	
Ex II 3 G Ex nA nC IIC T4 Gc X	
UL 508 Listed	
Class I, Div. 2, Groups A, B, C, D T4A	
Class I, Zone 2, Group IIC T4A	
B, B, A, A	

Description	Connection
Limit value switch with relay PDT output, standard configuration	Push-in connection
	Screw connection
	Push-in connection
	Screw connection

Ordering data		
Type	Order No.	Pcs./Pkt.
MINI MCR-2-UI-REL-PT	2902035	1
MINI MCR-2-UI-REL	2902033	1
MINI MCR-2-UI-REL-PT-C	2909887	1
MINI MCR-2-UI-REL-C	2909886	1

Programming adapter for configuring modules with S-PORT interface
USB programming adapter for configuring modules with Windows software
Bluetooth programming adapter , with USB and S-PORT interface

Accessories		
Type	Order No.	Pcs./Pkt.
IFS-USB-PROG-ADAPTER	2811271	1
TWN4 MIFARE NFC USB ADAPTER	2909681	1
IFS-BT-PROG-ADAPTER	2905872	1

MINI Analog Pro – Highly compact signal conditioners with plug-in connection technology

Order key for MINI MCR-2-UI-REL(-PT)(-C) 3-way signal conditioners (standard configuration entered as an example)

Order No.	Input	Start	End	Cut-off frequency
	Input signal			
2909886	I	0.0	24.0	15
2909886 ≙ MINI MCR-2- UI-REL-C	I ≙ I U ≙ U	0 ≙ 0 mA I: freely selectable between 0.0 ... 23.5 mA U: freely selectable between 0.0 ... 11.5 V	0 ≙ 0 mA I: freely selectable between 1 ... 24 mA U: freely selectable between 0.5 ... 12 V	15 ≙ 15 Hz 60 ≙ 60 Hz 240 ≙ 240 Hz
2909887 ≙ MINI MCR-2- UI-REL-PT-C				

Measuring range span at least 0.5 V/1 mA
Increment 0.1 V/0.1 mA

Output	Low switching point (SPL)	High switching point (SPH)	Switch-on delay	Switch-off delay	Error
Switching function					
2	--	10	0.0	0.0	0
0 ≙ L 1 ≙ H 2 ≙ L -->SPH -->H 3 ≙ H -->SPH -->L 4 ≙ L -->SPH -->H -->SPH -->L 5 ≙ H -->SPH -->L -->SPH -->H 6 ≙ L -->SPL -->H -->SPH -->L 7 ≙ H -->SPL -->L -->SPH -->H	-- ≙ Off I: ≙ freely selectable between 0.04 ... 23.96 mA U: freely selectable between 0.02 ... 11.98 V	10 ≙ 10 mA I: ≙ freely selectable between 0.08 ... 24 mA U: freely selectable between 0.04 ... 12 V	0 ≙ 0 sec. t: freely selectable between 0.0 ... 10 sec.	0 ≙ 0 sec. t: freely selectable between 0.0 ... 10 sec.	0 ≙ No response 1 ≙ 0 relay on 2 ≙ 0 relay off
	Only values for switching functions 4, 5, 6, 7 can be set	Only values for switching functions 2, 3, 4, 5, 6, 7 can be set			

Note:
L = Low (relay off)
H = High (relay on)
SPL = Setpoint Low
SPH = Setpoint High

Limit values
Temperature

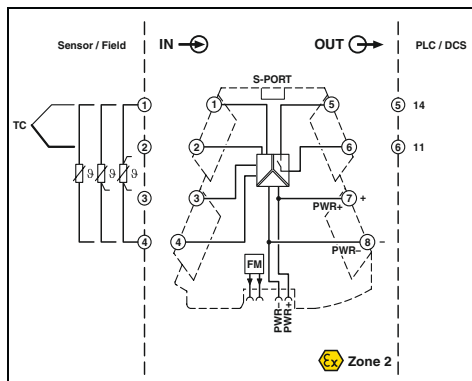
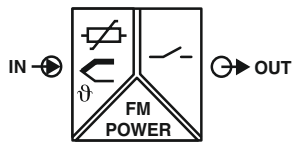

Configurable, temperature transducer with N/O relay output



Housing width 6.2 mm

- Universally configurable, highly-compact temperature limit value switch for switching analog limit values from resistance thermometers and remote resistance-type sensor signals
- For 2-, 3- or 4-conductor RTD sensors in accordance with IEC 751, JIS, GOST
- For thermocouples in accordance with IEC 584 and GOST
- 2-conductor resistance measurement, up to 4,000 Ω
- Internal cold junction compensation
- Plug-in connection system
- Safe 3-way isolation
- Standard behavior can be configured via DIP switches
- Freely configurable via software or smartphone app
- N/O relay output (N/C function can be set via software)
- Limiting continuous current up to 6 A
- Power supply and fault monitoring possible via DIN rail connector
- Status and error indicator LEDs

Input data

Input signal (can be configured using DIP switches)
Temperature range
Measuring range span
Linear resistance measuring range

Switching output

Relay output
Contact material
Max. switching voltage
Maximum switching current
Minimum switching current
Limiting continuous current
Hysteresis
Setting range of the response delay

General data

Supply voltage range
Current consumption

Switching point accuracy
Power consumption
Temperature coefficient
Step response (0 - 99%)

Electrical isolation

EMC note

Conformance/approvals

Conformance
ATEX
UL, USA/Canada

DNV GL

Technical data

Pt, Ni, Cu sensors : 2-, 3-, 4-conductor
-250°C ... 2500°C
min. 20 K
0 Ω ... 4,000 Ω

1 N/O contact
AgSnO₂, hard gold-plated
250 V AC
6 A (for 250 V AC)
100 mA (12 V DC)
6 A
Can be set freely via software
0 s ... 10 s (can be set freely via software)

9.6 V DC ... 30 V DC
44 mA (12 V DC)
22 mA (24 V DC)

<0.1%

570 mW

0.01%/K

Typically 300 ms
Typically 570 ms
Typically 380 ms
Typically 300 ms
Typically 570 ms

Reinforced insulation in accordance with IEC 61010-1
Class A product, see page 583

CE-compliant

Ex II 3 G Ex nA nC IIC T4 Gc X
UL 508 Listed
Class I, Div. 2, Groups A, B, C, D T4A
Class I, Zone 2, Group IIC T4A
B, B, A, A

Ordering data

Type	Order No.	Pcs./Pkt.
MINI MCR-2-T-REL-PT	2905633	1
MINI MCR-2-T-REL	2905632	1

Accessories

IFS-USB-PROG-ADAPTER	2811271	1
TWN4 MIFARE NFC USB ADAPTER	2909681	1
IFS-BT-PROG-ADAPTER	2905872	1

Notes:

The configuration software can be downloaded from the Internet: phoenixcontact.net/products.

Information on the programming adapters can be found on page 111

Description

Temperature limit value switches

Push-in connection
Screw connection

Programming adapter for configuring modules with S-PORT interface

USB programming adapter for configuring modules with Windows software

Bluetooth programming adapter, with USB and S-PORT interface

Limit values
Temperature

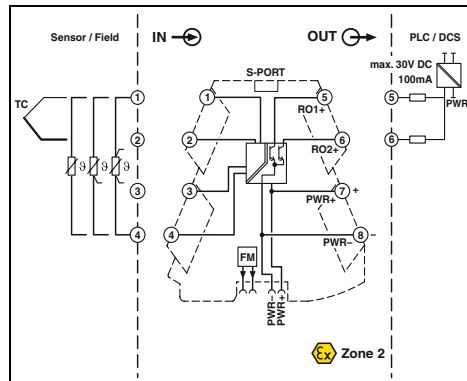
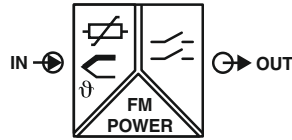

Configurable,
temperature transducer
with transistor output



Ex: Ex n Ex

Housing width 6.2 mm

- Universally configurable, highly-compact temperature limit value switch for switching analog limit values from resistance thermometers and remote resistance-type sensor signals
- For 2, 3 or 4-conductor RTD sensors in accordance with IEC 751, JIS, GOST
- For thermocouples in accordance with IEC 584 and GOST
- 2-conductor resistance measurement, up to 4,000 Ω
- Internal cold junction compensation
- Plug-in connection system
- Safe 3-way isolation
- Standard behavior can be configured via DIP switches
- Freely configurable via software or smartphone app
- 2 transistor switching contacts on the output
- Maximum switching current 30 V / 100 mA
- Power supply and fault monitoring possible via DIN rail connector
- Status and error indicator LEDs

Input data
Input signal (can be configured using DIP switches)
Temperature range
Measuring range span
Linear resistance measuring range
Switching output
Transistor output
Max. switching voltage
Maximum switching current
General data
Supply voltage range
Current consumption
Switching point accuracy
Power consumption
Temperature coefficient
Step response (0 - 99%)
Electrical isolation
EMC note
Conformance/approvals
Conformance
ATEX
UL, USA/Canada
DNV GL

Technical data

Pt, Ni, Cu sensors : 2-, 3-, 4-conductor
-250°C ... 2500°C
min. 20 K
0 Ω ... 4,000 Ω
2 N/O contacts
30 V DC
100 mA (30 V (≤50°C))
9.6 V DC ... 30 V DC
20 mA (12 V DC)
10 mA (24 V DC)
<0.1%
350 mW
0.01%/K
Typically 300 ms
Typically 570 ms
Typically 380 ms
Typically 300 ms
Typically 570 ms
Reinforced insulation in accordance with IEC 61010-1
Class A product, see page 583

CE-compliant
 Ex II 3 G Ex nA IIC T4 Gc X
 UL 508 Listed
 Class I, Div. 2, Groups A, B, C, D T6
 Class I, Zone 2, Group IIC T6
 B, B, A, A

Ordering data

Type	Order No.	Pcs./Pkt.
MINI MCR-2-T-2RO-PT	2906877	1
MINI MCR-2-T-2RO	2906876	1

Accessories

IFS-USB-PROG-ADAPTER	2811271	1
TWN4 MIFARE NFC USB ADAPTER	2909681	1
IFS-BT-PROG-ADAPTER	2905872	1

Notes:
The configuration software can be downloaded from the Internet: phoenixcontact.net/products.
Information on the programming adapters can be found on page 111

Description	Push-in connection Screw connection
Temperature limit value switches	
Programming adapter for configuring modules with S-PORT interface	
USB programming adapter for configuring modules with Windows software	
Bluetooth programming adapter , with USB and S-PORT interface	



Safely isolated from field to network. MINI Analog Pro signal conditioners with bus and network connections combine the benefits of safe electrical isolation with those of digital communication. With an overall width of less than 50 mm, you can transmit, free of interference, up to eight field signals to industrial networks, without the need for signal-specific input cards.

Further advantages:

- Gateways for different protocols: Modbus/RTU, Modbus/TCP, EtherNet/IP™, and PROFIBUS DP
- Interference-free signal transmission from the field level to the CPU, thanks to safe electrical isolation
- Fast, fault-free wiring, by bundling the signals in one network cable

MINI Analog Pro – Highly compact signal conditioners with plug-in connection technology



No need for input cards

- Cost and space savings, as signal-specific input cards are no longer needed



Modular and space-saving

- Space-saving network integration of freely combinable signal conditioners by means of plug-in gateways



Flexible configuration

- Quick configuration via rotary coding switch, software, web server or app



Smart configuration and monitoring

- Carry out on-site configuration and read current values directly off a smartphone with the MINI Analog Pro app



Easy startup and service

- Measure current signals during operation, without disconnecting current loops

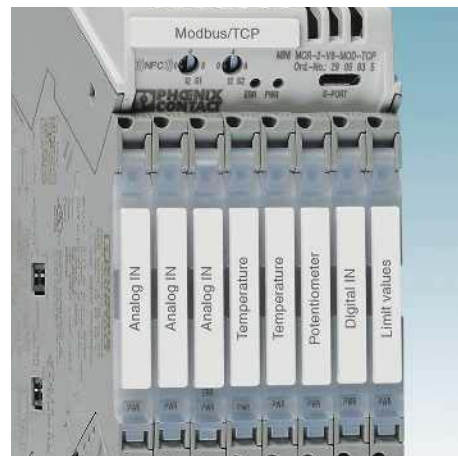

Easy maintenance

- Large-surface marking areas for standard marking material as well as permanently visible status and error LEDs on each module

MINI Analog Pro gateways

- Easy integration of up to eight field signals into the bus systems
- Any combination of signal conditioners is possible (standard signal, temperature, etc.)
- Easy attachment to the output side of MINI Analog Pro modules
- Huge savings in terms of input cards and bus couplers
- Safe channel-to-channel electrical isolation right through to the CPU
- Versions available with Modbus/RTU or PROFIBUS DP
- Can be configured via software or smartphone app

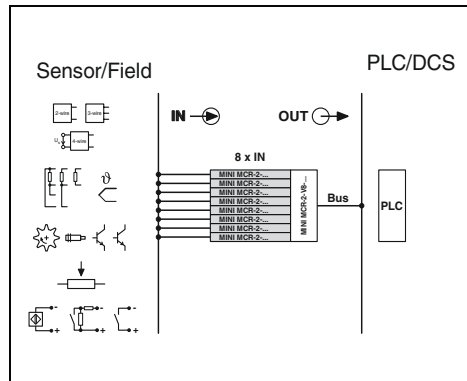

Gateway for bus and network connection

Ex: EAC
Housing width 51.1 mm

Notes:
The configuration software can be downloaded from the Internet: phoenixcontact.net/products.
Information on the programming adapters can be found on page 111

Input data	
Number of inputs	8
Configurable/programmable	Yes
Current input signal	4 mA ... 20 mA
Maximum input current	24 mA
Input resistance of current input	50 Ω
Maximum input voltage	5 V
Output data	
Number of outputs	1
Data update rate	15 ms
General data	
Nominal supply voltage range	12 V ... 24 V
Supply voltage range	9.6 V ... 30 V
Power consumption	<1,000 mW
Maximum transmission error	0.1%
Temperature coefficient	0.01%
Test voltage, input/output/supply	0.5 kV
Ambient temperature (operation)	-40°C ... 65°C
Housing material	PBT 7% GF V0
Dimensions W/H/D	51.1 / 104.1 / 56.8 mm
EMC note	Class A product, see page 583
Conformance/approvals	
Conformance	CE-compliant
UL, USA/Canada	UL 61010 Listed Class I, Div. 2, Groups A, B, C, D T5 Class I, Zone 2, Group IIC T5

Technical data

Number of inputs	8
Configurable/programmable	Yes
Current input signal	4 mA ... 20 mA
Maximum input current	24 mA
Input resistance of current input	50 Ω
Maximum input voltage	5 V
Number of outputs	1
Data update rate	15 ms
Nominal supply voltage range	12 V ... 24 V
Supply voltage range	9.6 V ... 30 V
Power consumption	<1,000 mW
Maximum transmission error	0.1%
Temperature coefficient	0.01%
Test voltage, input/output/supply	0.5 kV
Ambient temperature (operation)	-40°C ... 65°C
Housing material	PBT 7% GF V0
Dimensions W/H/D	51.1 / 104.1 / 56.8 mm
EMC note	Class A product, see page 583
Conformance/approvals	CE-compliant UL 61010 Listed Class I, Div. 2, Groups A, B, C, D T5 Class I, Zone 2, Group IIC T5

Description	
For bus and network connection	
Modbus/RTU	
PROFIBUS DP	
Programming adapter for configuring modules with S-PORT interface	
USB programming adapter for configuring modules with Windows software	
Bluetooth programming adapter , with USB and S-PORT interface	

Ordering data

Type	Order No.	Pcs./Pkt.
MINI MCR-2-V8-MOD-RTU	2905634	1
MINI MCR-2-V8-PB-DP	2905636	1

Accessories

IFS-USB-PROG-ADAPTER	2811271	1
TWN4 MIFARE NFC USB ADAPTER	2909681	1
IFS-BT-PROG-ADAPTER	2905872	1

MINI Analog Pro gateways

- Easy integration of up to eight field signals in the bus systems
- Any combination of signal conditioners is possible (standard signal, temperature, etc.)
- Easy attachment to the output side of MINI Analog Pro modules
- Huge savings in terms of input cards and bus couplers
- Safe channel-to-channel electrical isolation right through to the CPU
- Versions available with Modbus/TCP or EtherNet/IP™
- Can be configured via software or smartphone app

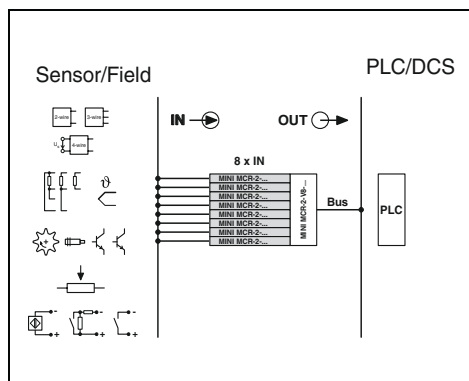

Gateway for bus and network connection



Housing width 51.1 mm

Notes:

The configuration software can be downloaded from the Internet: phoenixcontact.net/products.

Information on the programming adapters can be found on page 111

Input data	
Number of inputs	8
Configurable/programmable	Yes
Current input signal	4 mA ... 20 mA
Maximum input current	24 mA
Input resistance of current input	50 Ω
Maximum input voltage	5 V
Output data	
Number of outputs	1
Data update rate	15 ms
General data	
Nominal supply voltage range	12 V ... 24 V
Supply voltage range	9.6 V ... 30 V
Power consumption	<1200 mW
Maximum transmission error	0.1%
Temperature coefficient	0.01%
Test voltage, input/output/supply	0.5 kV
Ambient temperature (operation)	-40°C ... 55°C
Housing material	PBT 7% GF V0
Dimensions W/H/D	51.1 / 104.1 / 61 mm
EMC note	Class A product, see page 583
Conformance/approvals	
Conformance	CE-compliant
UL, USA/Canada	UL 508 Listed Class I, Div. 2, Groups A, B, C, D T5 Class I, Zone 2, Group IIC T5

Technical data

Description
Gateways for bus and network connection
Modbus/TCP

Ordering data

Type	Order No.	Pcs./Pkt.
MINI MCR-2-V8-MOD-TCP	2905635	1

Programming adapter for configuring modules with S-PORT interface
USB programming adapter for configuring modules with Windows software
Bluetooth programming adapter , with USB and S-PORT interface

Accessories

Type	Order No.	Pcs./Pkt.
IFS-USB-PROG-ADAPTER	2811271	1
TWN4 MIFARE NFC USB ADAPTER	2909681	1
IFS-BT-PROG-ADAPTER	2905872	1

System cabling solutions for your MINI Analog Pro signal conditioners



System cabling adapter for plugging on to up to eight MINI Analog Pro signal conditioners

Thanks to its innovative plug-in concept, the MINI MCR-2-V8-FLK 16 system adapter offers a time-saving wiring solution. Eight MINI Analog Pro signal converters connect easily to a controller using pluggable system cabling. This leads to a considerable reduction in cabling effort and the risk of wiring errors compared to individual wiring on the controller side: Using the system cabling allows you to connect the MINI Analog Pro modules by simply plugging them on to the PLC.

The FLK 16 system adapter also offers all the advantages of gateways to bus and network connection, such as configuration and readout of measurement values over NFC, continuous measurement of currents, a generous marking area, and always visible diagnostic and status LEDs.

Further advantages:

- Plug and Play solution for your MINI Analog Pro signal conditioners
- Safe galvanic isolation per channel combined with major time and cost savings
- Saves space, thanks to modular plugging of the system cabling adapter

Termination Carriers for your MINI Analog Pro signal conditioners



TC... Termination Carriers are compact solutions for conveniently and smoothly connecting standard DIN rail signal conditioners from the MINI Analog Pro series to input and output cards of automation systems using system cabling. Termination Carriers are also available for MACX Analog and PSR safety devices.

The most compact signal conditioners combined with the most compact and flexible module carriers on the market enable you to achieve a hitherto unparalleled packing density in your control cabinet together with professional system cabling.

Compact

- The compact design combined with MINI Analog saves up to 65% of space in the control cabinet

Rugged and reliable

- Stable, vibration-resistant aluminum carrier device profile
- PCB is completely decoupled from signal conditioners
- PCB without active electronics
- Redundant supply via separate DIN rail module
- Horizontal or vertical DIN rail mounting

Flexible

- Profile sections without pitch markings
- Quick and safe module connection with plug-in cable sets
- Horizontal or vertical DIN rail mounting
- Can be flexibly adapted to suit any controller or higher-level control system
- Solutions tailored to your requirements on request
- Available pre-assembled with modules and wired, or for self-assembly



Select standard DIN rail device

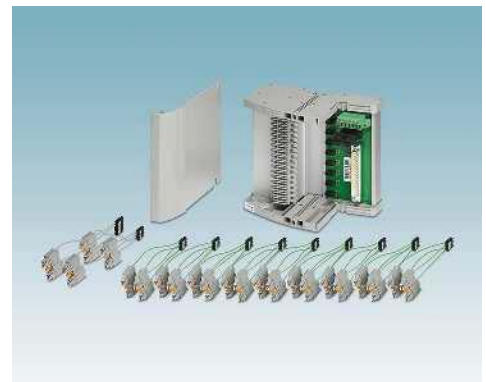

Select module carrier



Select controller-specific front adapter and system cable

MINI Analog Pro system adapters

- Time-saving wiring solution thanks to unique plug-in concept
- System cabling on PLC side
- Plug-and-Play
- For up to eight channels
- Reduces wiring costs and errors
- Easy attachment to the output side of MINI Analog Pro modules
- Especially easy to maintain, thanks to interruption-free current measurement function

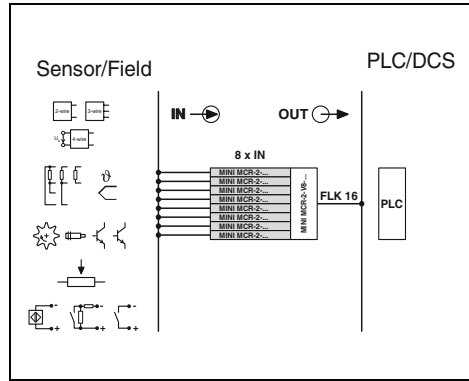

System cabling adapter

Ex: EAC
Housing width 51.1 mm

Input data	
Number of inputs	8
Configurable/programmable	no
Maximum input current	4 A (500 mA per ch.)
Maximum input voltage	30 V
Output data	
Number of outputs	8
Connection method	IDC/FLK pin strip
Configurable/programmable	no
General data	
Test voltage input/output	0.5 kV
Rated insulation voltage	50 V _{rms}
Degree of protection	IP20
Overvoltage category / Degree of pollution	II / 2
Ambient temperature (operation)	-40°C ... 70°C
Humidity	5% ... 95%
Maximum altitude for use above sea level	4,000 m
Housing material	PBT 7% GF V0
Dimensions W/H/D	51.1 / 104.1 / 56.8 mm
Conformance/approvals	
Conformance	CE-compliant
ATEX	II 3 G Ex nA IIC Gc U
UL, USA/Canada	UL 61010 Listed Class I, Div. 2, Groups A, B, C, D T5 Class I, Zone 2, Group IIC T5
GL	GL applied for

Technical data

Ordering data		
Type	Order No.	Pcs./Pkt.
MINI MCR-2-V8-FLK 16	2901993	1

Description
System cabling adapter for MINI Analog Pro modules

MINI Analog Pro – Highly compact signal conditioners with plug-in connection technology

Termination Carriers for your MINI Analog Pro signal conditioners

The **TC-D37SUB-ADIO16-MP-P-UNI** universal Termination Carrier is a compact solution which connects signal conditioners from the MINI Analog Pro series to analog or binary input and output cards of automation systems.

- The **TC-D37SUB-AIO16-MP-PS-UNI** Termination Carrier design, when combined with the MACX MCR-S-MUX HART multiplexer, also enables communication between HART-compatible field devices and a management system.
- Connection of up to 16 single-channel signal conditioners
- Universal 1:1 signal routing to a 37-pos. D-SUB connector
- For system cables with D-SUB socket and open ends for universal connection
- Redundant supply and monitoring via separate MINI MCR-2-PTB-PT feed-in terminal and MINI MCR-2-FM-RC-PT fault signaling module

Notes:
Contact us: together, we can develop optimum solutions for your automation system with the Termination Carrier for MINI Analog Pro.
TC-D37SUB-ADIO16-MP-P-UNI (Order No. 2906639) is not a class A product.

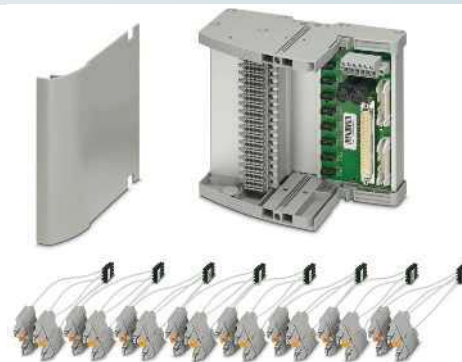

EAC
 Ex:
 Housing width 136 mm

Technical data	
General data	
Connection to the control system level	D-SUB pin strip
No. of pos.	37
Maximum operating voltage	<30 V DC (per signal/channel)
Maximum permissible current	23 mA (signal/channel)
Rated insulation voltage	50 V (basic insulation)
Rated surge voltage	0.5 kV
Degree of pollution	2
Overvoltage category	II
Air clearances and creepage distances	DIN EN 50178 (basic insulation)
Ambient temperature range	-20°C ... 60°C (please observe module specifications)
Shock	15g, in accordance with IEC 60068-2-27
Vibration (operation)	2g, in accordance with IEC 60068-2-6
Dimensions W/H/D	136 / 170 / 160 mm
Power supply via power module	
Input voltage range	19.2 V DC ... 30 V DC
Redundant supply	Yes, decoupled from diodes
Polarization and surge protection	Yes
Fuse	2x 2.5 A on PCB, slow-blow (replaceable)
Status indication	2 x red LED (error) 2 x green LEDs (PWR1 and PWR2) 1 N/C contact (alarm = open)

General data	
Connection to the control system level	D-SUB pin strip
No. of pos.	37
Maximum operating voltage	<30 V DC (per signal/channel)
Maximum permissible current	23 mA (signal/channel)
Rated insulation voltage	50 V (basic insulation)
Rated surge voltage	0.5 kV
Degree of pollution	2
Overvoltage category	II
Air clearances and creepage distances	DIN EN 50178 (basic insulation)
Ambient temperature range	-20°C ... 60°C (please observe module specifications)
Shock	15g, in accordance with IEC 60068-2-27
Vibration (operation)	2g, in accordance with IEC 60068-2-6
Dimensions W/H/D	136 / 170 / 160 mm
Power supply via power module	
Input voltage range	19.2 V DC ... 30 V DC
Redundant supply	Yes, decoupled from diodes
Polarization and surge protection	Yes
Fuse	2x 2.5 A on PCB, slow-blow (replaceable)
Status indication	2 x red LED (error) 2 x green LEDs (PWR1 and PWR2) 1 N/C contact (alarm = open)

Ordering data	
Description	
Module carrier for 16 MINI Analog channels, power and feed-through module	
- With connection for MACX MCR-S-MUX HART multiplexer	
Type	Order No. Pcs./Pkt.
TC-D37SUB-AIO16-MP-PS-UNI	2906640 1
TC-D37SUB-ADIO16-MP-P-UNI	2906639 1

Accessories	
MINI Analog Pro power terminal block	MINI MCR-2-PTB-PT 2902067 1
MINI Analog Pro error signaling module	MINI MCR-2-FM-RC-PT 2904508 1
HART multiplexer, 32-channel, including two 14-conductor flat-ribbon cable	MACX MCR-S-MUX 2865599 1

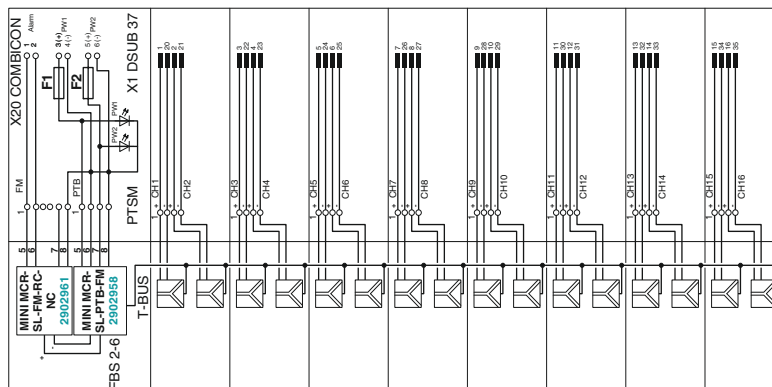

TC-D37SUB-ADIO16-M-P-UNI and TC-D37SUB-AIO16-M-PS-UNI connection scheme

Accessories

Constant voltage/constant current sources

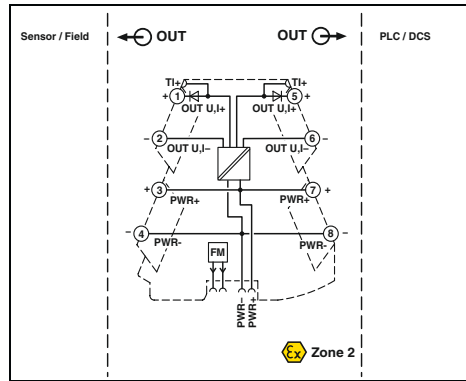
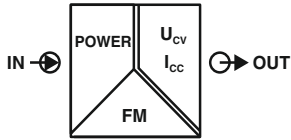

Configurable output signals



Housing width 6.2 mm

- Constant voltage/constant current source for potentiometers, measuring bridges, encoders, etc.
- Plug-in connection system
- Highly precise
- Output signals can be configured via DIP switches
- Input signal corresponds to power supply
- Input signal and therefore energy supply and fault monitoring via the DIN rail connector
- For voltages up to 10 V and currents up to 20 mA
- Status LED

Input data
Input signal
Output data
Output signal (can be configured using DIP switches)
Short-circuit current
Ripple
General data
Supply voltage range
Power consumption
Maximum transmission error
Temperature coefficient
Electrical isolation
Degree of protection
EMC note
Conformance/approvals
Conformance
ATEX
UL, USA/Canada
DNV GL

Technical data	
9.6 ... 30 V	
U output	I output
10 V DC	20 mA
8.75 V DC	17.5 mA
7.5 V DC	15 mA
6.25 V DC	12.5 mA
5 V DC	10 mA
3.75 V DC	7.5 mA
2.5 V DC	5 mA
1.25 V DC	2.5 mA
>32 mA	
<20 mV _{pp} (at 600 Ω)	
9.6 V DC ... 30 V DC	
<1.1 W (9.6 V DC)	
≤0.1% (of final value)	
<0.01%/K	
Reinforced insulation in accordance with IEC 61010-1	
IP20	
Class A product, see page 583	
CE-compliant	
Ex II 3 G Ex nA IIC T4 Gc X	
UL 508 Listed	
Class I, Div. 2, Groups A, B, C, D T6	
Class I, Zone 2, Group IIC T6	
B, B, A, A	

Description
Constant voltage/constant current source
Push-in connection
Screw connection
Setpoint potentiometer, to set setpoints individually
Resistance value 4.7 kΩ
Resistance value 10 kΩ

Ordering data		
Type	Order No.	Pcs./Pkt.
MINI MCR-2-CVCS-PT	2902065	1
MINI MCR-2-CVCS	2902064	1

Accessories		
Type	Order No.	Pcs./Pkt.
EMG 30-SP- 4K7LIN	2940252	10
EMG 30-SP-10K LIN	2942124	10

MINI Analog Pro – Highly compact signal conditioners with plug-in connection technology

Accessories
Connector set

- FASTCON Pro connector set
- Consisting of four connectors, one each for every position on the module
- Suitable for all MINI Analog Pro modules
- Four-way coding prevents incorrect insertion into the device
- Screw or Push-in connection technology



With Push-in connection



With screw connection

Technical data
Connection data solid/stranded/AWG
Description
FASTCON Pro connector set - with Push-in connection - with screw connection

Technical data		
0.14 ... 2.5 mm ² / 0.14 ... 2.5 mm ² / 24 - 12		
Ordering data		
Type	Order No.	Pcs./Pkt.
FASTCON PRO-SET-PT	2906228	1

Technical data		
0.2 ... 1.5 mm ² / 0.2 ... 1.5 mm ² / 24 - 12		
Ordering data		
Type	Order No.	Pcs./Pkt.
FASTCON PRO-SET	2906227	1

Accessories,
constant voltage sources

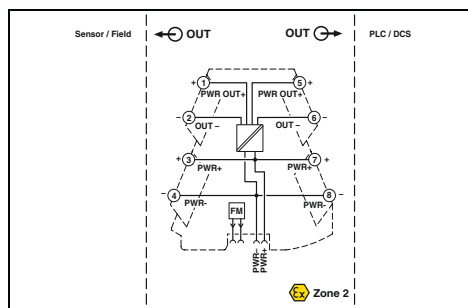
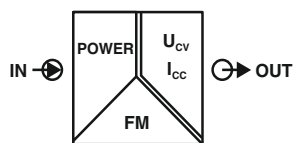

Ex n



new

- Sensor feed from 2-conductor or 3-conductor 15 V / 30 mA sensors
- 15 V constant voltage source for sensors, encoders, etc.
- Plug-in connection system
- Input signal corresponds to power supply
- Input signal and therefore energy supply and fault monitoring via the DIN rail connector
- Status LED

Input data
Input signal
Output data
Output signal (can be configured using DIP switches)
Short-circuit current
Ripple
General data
EMC note
Conformance/approvals
Conformance
ATEX
UL, USA/Canada

Description
Constant voltage source with Push-in connection with screw connection
Push-in connection Screw connection

Technical data	
9.6 ... 30 V	
U output	I output
15 V DC	
>35 mA	
<20 mV _{pp} (at 600 Ω)	
Class A product, see page 583	
CE-compliant	
II 3 G Ex nA IIC T4 Gc X	
UL 508 Listed	
Class I, Div. 2, Groups A, B, C, D T6	
Class I, Zone 2, Group IIC T6	

Ordering data		
Type	Order No.	Pcs./Pkt.
MINI MCR-2-SPS-24-15-PT	1033201	1
MINI MCR-2-SPS-24-15	1033202	1

MINI Analog Pro – Highly compact signal conditioners with plug-in connection technology

Accessories

DIN rail connectors for bridging the supply voltage

ME 6,2 TBUS

- Module replacement without interrupting the supply to the remaining modules (hot swappable)
- One DIN rail connector for two MINI Analog Pro modules

ME 17,5 TBUS

- For use with a MINI POWER system power supply unit



For bridging the supply voltage



For system power supply

Description	Ordering data			Ordering data		
	Type	Order No.	Pcs./Pkt.	Type	Order No.	Pcs./Pkt.
DIN rail connector , for bridging the supply voltage, can be snapped onto 35 mm DIN rails in accordance with EN 60715, UL-approved Color: gray Color: green	ME 6,2 TBUS-2 1,5/5-ST-3,81 GY ME 6,2 TBUS-2 1,5/5-ST-3,81 GN	2695439 2869728	10 10			
DIN rail connector , for bridging the supply voltage, can be snapped onto 35 mm DIN rails as per EN 60715, with UL approval, two pieces are required per system power supply Color: green				ME 17,5 TBUS 1,5/ 5-ST-3,81 GN	2709561	10

Accessories

System power supplies

- For supplying the supply voltage via the DIN rail connector where AC voltages are available
- Nominal input voltage range 100 ... 240 V AC
- 24 V DC output voltage
- For up to 60 MINI Analog modules
- For up to 1.5 A, secondary
- Status and error signaling via diagnostic LEDs



For applications with local voltages of over 100 V

Description	Ordering data		
	Type	Order No.	Pcs./Pkt.
System power supply , primary-switched, with zone 2 approval. Further information can be found in Catalog 4, surge protection and power supplies.	MINI-PS-100-240AC/24DC/1.5/EX	2866653	1
System power supply , primary-switched (not for zone 2). You can find further information in Catalog 4, surge protection and power supplies.	MINI-SYS-PS-100-240AC/24DC/1.5	2866983	1

Accessories

Power terminal blocks

- Power terminal block for supplying the supply voltage to the DIN rail connector
- Plug-in connection system
- Increased output current of 3.2 A
- For up to 115 MINI Analog Pro modules
- Monitoring of supplies in combination with the fault monitoring module
- Flexible redundant supply from one or both module sides
- Status and error indicator LEDs

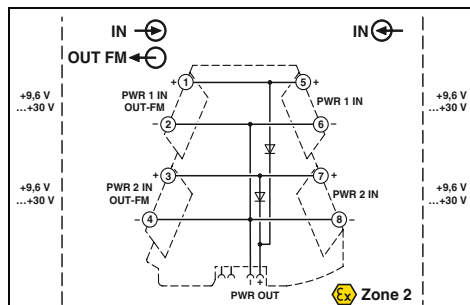

Redundant supply for existing 24 V

Notes:
Pay attention to the supply instructions for the MINI and MACX modules.

Input data/output data	
Input voltage range	9.9 V DC ... 30 V DC
Output voltage	9.6 V DC ... 29.7 V DC
Output current	≤3.2 A
General data	
EMC note	Class A product, see page 583
Conformance/approvals	
Conformance	CE-compliant
ATEX	Ex II 3 G Ex nA IIC T4 Gc X
UL, USA/Canada	UL 508 Listed Class I, Div. 2, Groups A, B, C, D T6 Class I, Zone 2, Group IIC T6 C, EMC2
DNV GL	

Technical data

Technical data		
9.9 V DC ... 30 V DC		
9.6 V DC ... 29.7 V DC		
≤3.2 A		
Class A product, see page 583		
CE-compliant		
Ex II 3 G Ex nA IIC T4 Gc X		
UL 508 Listed		
Class I, Div. 2, Groups A, B, C, D T6		
Class I, Zone 2, Group IIC T6		
C, EMC2		

Description	
MINI Analog Pro power terminal block	
Push-in connection	
Screw connection	

Ordering data

Type	Order No.	Pcs./Pkt.
MINI MCR-2-PTB-PT	2902067	1
MINI MCR-2-PTB	2902066	1

Accessories

Setpoint potentiometers

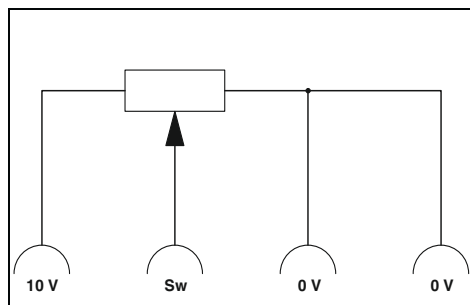
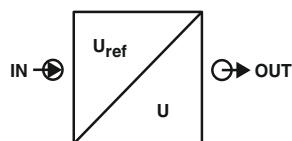

- For direct setpoint definition in combination with a constant voltage source

Input data	
Resistance value	4.7 kΩ ±20%
Linearity	5% (of final value)
Load capacity	0.5 W
General data	
Ambient temperature (operation)	0°C ... 40°C
Mounting	Any
Housing material	Polycarbonate fiber reinforced PC-F
Dimensions W/H/D	30 / 75 / 68 mm
Screw connection rigid / flexible / AWG	0.2 ... 4 mm² / 0.2 ... 2.5 mm² / 24 - 14

Technical data

Technical data		
EMG 30-SP- 4K7LIN	EMG 30-SP-10K LIN	
4.7 kΩ ±20%	10 kΩ ±20%	
5% (of final value)	5% (of final value)	
0.5 W	0.5 W	
0°C ... 40°C		
Any		
Polycarbonate fiber reinforced PC-F		
30 / 75 / 68 mm		
0.2 ... 4 mm² / 0.2 ... 2.5 mm² / 24 - 14		

Description	
Setpoint potentiometer, to set setpoints individually	
Resistance value 4.7 kΩ	
Resistance value 10 kΩ	

Ordering data

Type	Order No.	Pcs./Pkt.
EMG 30-SP- 4K7LIN	2940252	10
EMG 30-SP-10K LIN	2942124	10

MINI Analog Pro – Highly compact signal conditioners with plug-in connection technology

Accessories

Feed-through terminal blocks

- Feed-through terminal block for 1:1 forwarding of signals that are already electrically isolated in the MINI Analog Pro group
- Plug-in connection system

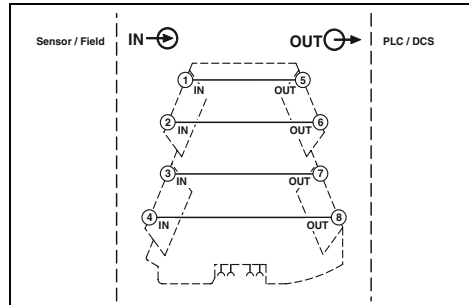

For signals already electrically isolated

General data	
Degree of protection	IP20
Ambient temperature (operation)	-40°C ... 70°C
Mounting	any
Housing material	PBT
Dimensions W/H/D	6.2 / 110.5 / 120.5 mm
Screw connection rigid / flexible / AWG	0.2 ... 1.5 mm ² / 0.2 ... 1.5 mm ² / 24 - 12
Conformance/approvals	
Conformance	CE-compliant
ATEX	Ex II 3 G Ex nA IIC T4 Gc X
UL, USA/Canada	UL 508 Listed Class I, Div. 2, Groups A, B, C, D T6 Class I, Zone 2, Group IIC T6 C, EMC2
DNV GL	

Technical data		
Type	Order No.	Pcs./Pkt.
MINI MCR-2-TB	2902068	1

Description	
MINI Analog Pro feed-through terminal block	Screw connection

Ordering data		
Type	Order No.	Pcs./Pkt.
MINI MCR-2-TB	2902068	1

Accessories

Error message modules

- Fault monitoring module for evaluating and reporting group errors from the fault monitoring system
- Monitoring of up to 115 connected MINI Analog Pro modules
- Plug-in connection system
- Monitoring of supply voltages of MINI MCR-2-PTB(-PT) power terminal blocks
- Drawing off the supply is possible
- Fault signaling via an N/C contact
- Status and error indicator LEDs
- CE-compliant

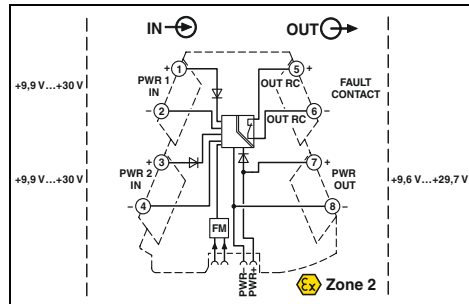

For group error message and supply monitoring

Input data/output data	
Input signal	9.9 V DC ... 30 V DC
Output signal	9.6 V DC ... 29.7 V DC
Switching output	
Max. switching voltage	30 V DC
Maximum switching current	50 mA
General data	
Test voltage input/output	1.5 kV AC (50 Hz, 1 min.)
EMC note	Class A product, see page 583
Conformance/approvals	
ATEX	Ex II 3 G Ex nA IIC T4 Gc X
UL, USA/Canada	UL 508 Listed Class I, Div. 2, Groups A, B, C, D T6 Class I, Zone 2, Group IIC T6 C, EMC2
DNV GL	

Technical data		
Type	Order No.	Pcs./Pkt.
MINI MCR-2-FM-RC-PT	2904508	1
MINI MCR-2-FM-RC	2904504	1

Description	
MINI Analog Pro error signaling module	Push-in connection Screw connection

Ordering data		
Type	Order No.	Pcs./Pkt.
MINI MCR-2-FM-RC-PT	2904508	1
MINI MCR-2-FM-RC	2904504	1

Accessories

Programming adapters

IFS-USB-PROG-ADAPTER programming adapter for configuring Phoenix Contact INTERFACE modules with S-PORT interface.

The adapters are used with the FDT/DTM or the ANALOG-CONF software. For programming the MACX Analog, MINI Analog Pro, and MINI Analog.



General data		Technical data		
EMC note		Class A product, see page 583		
Description		Ordering data		
Programming adapter for configuring modules with S-PORT interface		Type	Order No.	Pcs./Pkt.
Bluetooth programming adapter, with USB and S-PORT interface		IFS-USB-PROG-ADAPTER	2811271	1
		IFS-BT-PROG-ADAPTER	2905872	1

Accessories

Marking labels for transparent cover

- Snap-in labels and adhesive labels with large-area for marking
- For snapping into or sticking onto MINI Analog Pro covers, without overlapping the status and error LEDs
- The sheets can be marked quickly and easily using the BLUEMARK CLED and the THERMOMARK CARD...
- They can also be custom printed in accordance with customer requirements



Unlabeled or labeled in accordance with customer specifications

Description		Ordering data			Ordering data		
Description	Color	Type	Order No.	Pcs./Pkt.	Type	Order No.	Pcs./Pkt.
UniCard, for marking the CLIPFIX 35-5, 24-part end brackets, 8 individual labels per strip, lettering field size: 30 x 5 mm	white	UCT-EM (30X5)	0801505	10			
Lettering field size: 30 x 5 mm	white	UCT-EM (30X5) CUS	0801589	1			
10-section, lettering field size: 15 x 5 mm	white	UC-EMLP (15X5)	0819301	10			
10-section, lettering field size: 15 x 5 mm	white	UC-EMLP (15X5) CUS	0824550	1			
Continuous labels, can be marked with thermal transfer printer, can be separated with a cutter, pitch as desired, strip length up to 1,000 mm					SK 5,0 WH:REEL	0805221	1
1 roll = 90 m continuous, height: 5.0 mm, 10 strips	white						



Reliable and safe

In all phases of the product lifecycle, MACX signal conditioners have been developed and produced in accordance with IEC 61508 standards for functional safety. This ensures the highest level of safety for your machines and systems. Save planning and operating costs by combining high signal flexibility with comprehensive SIL certification.



From the cost-effective standard signal conditioner to multifunctional universal devices, MACX signal conditioners provide you with comprehensive solutions for signal processing.



In addition to being SIL-certified, certain MACX signal conditioners also feature performance level PL d. This means that you can integrate analog signals easily into your safety application in accordance with the Machinery Directive.

Versions with PL d and Ex i approval are also available.



All Ex i versions are SIL-certified and also have ATEX and IECEx approval. Single and two-channel signal isolators are available for intrinsically safe circuits up to zone 0 and zone 20 and for all gas and dust groups – with an overall width of just 12.5 mm. The products are type-tested by an independent NAMUR test laboratory in accordance with NE 95, ensuring that they satisfy the high requirements of the chemical industry.



Reliable and safe

Highest safety for your machines and systems.

Phoenix Contact meets the requirements of functional safety in accordance with IEC 61508 in a standardized development process. We take measures for fault avoidance and fault control into consideration, from the development and production of a device up to device operation.

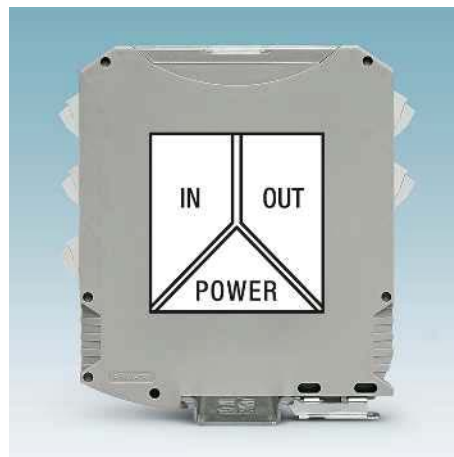

Precise, interference-free signal transmission and long service life

- Patented transmission concept with safe electrical isolation
- Low power consumption and self-heating



Easy configuration and monitoring

- Either via FDT/DTM or alternatively with user-friendly stand-alone software – with integrated monitoring function
- Or without software via DIP switches on the housing front



Intelligent concept for supply and diagnostics

- 24 Volt power bridging via DIN rail connector for easy wiring, system expansion, or hot-swap module replacement. Direct feed via a MACX module or via supply and fault reporting module with the option of redundant, diode-decoupled supply and fault reporting
- Wide-range power supply: Versions with wide range input for direct installation in all power supply networks – anywhere in the world with no additional power supply unit required



Fast, error-free signal connection

- Compact Termination Carriers for quickly and smoothly connecting MACX DIN rail devices to automation system input and output cards using preassembled VARIOFACE system cabling – Plug and Play
- Saves up to 30% of space when compared to other solutions on the market
- High system availability, thanks to robust aluminum profile with mechanically decoupled PCB
- Easy to service, with a single engineering design for both DIN rail and system applications



Easy-maintenance connection technology

- Plug-in connection technology, with either screw connection or a spring-cage version with fast Push-in technology
- Coding and clear marking ensure reliable protection against polarity reversal and prevent unintentional mismatching of pre-conductor connection terminal blocks
- Integrated sockets for testing, or for connecting to HART communicators, for example

Intrinsically safe signal transmission in potentially explosive areas

Many process technology systems have areas where potentially explosive atmospheres may occur. As such, measuring and control circuits around the world are usually designed with intrinsic safety protection (Ex i).

The **intrinsic safety type of protection**, as opposed to other types of protection (such as increased safety, or Ex e), refers not only to an individual item of equipment but to the entire circuit. A circuit is described as intrinsically safe if the current and voltage are limited to such an extent that no spark or thermal effect can cause a potentially explosive atmosphere to ignite.

An intrinsically safe circuit typically consists of at least one item of intrinsically safe equipment (field device) and one item of

associated equipment (Ex i signal conditioner) and the connecting cables. Intrinsically safe equipment and intrinsically safe parts of associated items of equipment are classed in accordance with IEC/EN 60079-11 in safety levels ia, ib, and ic. The demonstration of intrinsic safety that the user is required to carry out as described in IEC/EN 60079-14, among others, serves to ensure that the interconnection described above is intrinsically safe.

This type of protection offers the user the following advantages, among others:

- Service and conversions while the system is operating requiring no special permits
- Cost-effective, thanks to the lack of expensive housing designs
- Ex i field devices and Ex i signal conditioners can be combined regardless of manufacturer

See our free brochure for detailed information on the topic of explosion protection:

https://www.phoenixcontact.com/assets/downloads_ed/global/web_dwl_promotion/5149416_EN_HQ_Explosion_protection_LoRes.pdf

Order No. 5149416

Installation examples for intrinsically safe circuits:

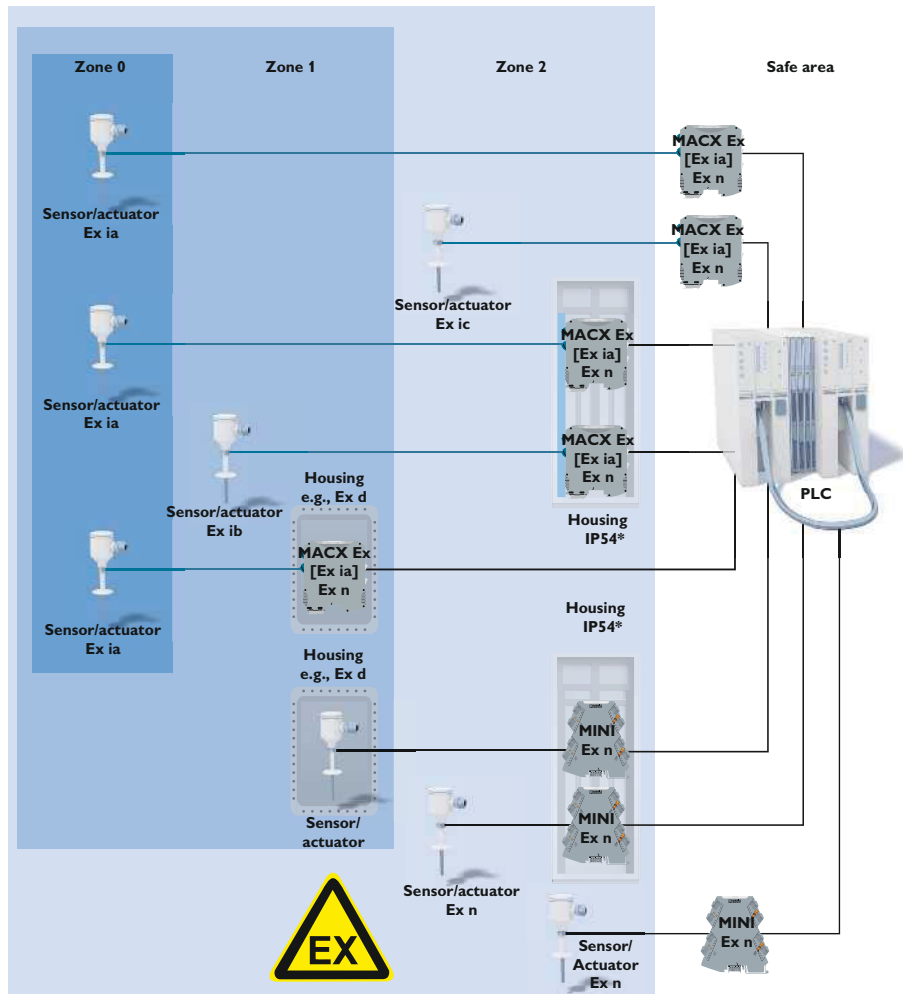

MACX Analog – Signal conditioners with functional safety and explosion protection

Functional safety (SIL)

The term SIL (safety integrity level) is an important one in the field of process technology. It defines the requirements that a device or a system is expected to fulfill so that the failure probability can be specified. If a device or system fails, a defined safe state is attained.

The basic standard **IEC 61508** “Functional safety of electrical/electronic/programmable electronic safety-related systems” describes the requirements that manufacturers must take into consideration for their devices or systems.

The standard **IEC 61511** “Functional safety – Safety instrumented systems for the process industry sector” describes the requirements for constructing systems with functional safety. The operator, proprietor, and planner are responsible for complying with this standard in observance of national regulations.

The attached table is an excerpt from IEC 61508 and IEC 61511 and describes the correlation between the average probability of failure and the SIL level of the safety instrumented function (SIF) attained and the reduction in risk.

SIL Safety Integrity Level	PFD _{avg} Low demand mode (average probability of failure of the function on demand)	PFH High demand mode (Probability of a dangerous failure per hour)	RRF Risk reduction factor (Risk Reduction Factor)
SIL 1	$\geq 10^{-2} \dots <10^{-1}$	$\geq 10^{-6} \dots <10^{-5}$	$\leq 100 \dots >10$
SIL 2	$\geq 10^{-3} \dots <10^{-2}$	$\geq 10^{-7} \dots <10^{-6}$	$\leq 1,000 \dots >100$
SIL 3	$\geq 10^{-4} \dots <10^{-3}$	$\geq 10^{-8} \dots <10^{-7}$	$\leq 10,000 \dots >1,000$
SIL 4	$\geq 10^{-5} \dots <10^{-4}$	$\geq 10^{-9} \dots <10^{-8}$	$\leq 100,000 \dots >10,000$

Functional safety (PL)

The term Performance Level (PL) in accordance with EN ISO 13849 refers to safety of machinery. The attached table depicts the correlation between the required Performance Level (PL) and the average probability of a dangerous failure per hour (PFH_d).

PL Performance level	PFH _d Probability of dangerous failure on average per hour
PL a	$10^{-5} \leq PFH_d <10^{-4}$
PL b	$3 \times 10^{-6} \leq PFH_d <10^{-5}$
PL c	$10^{-6} \leq PFH_d <3 \times 10^{-6}$
PL d	$10^{-7} \leq PFH_d <10^{-6}$
PL e	$10^{-8} \leq PFH_d <10^{-7}$

Furthermore, parameters such as category, degree of diagnostic coverage (DC), and mean time to dangerous failure (MTTF_d) must be taken into consideration for safety of machinery in accordance with EN ISO 13849.

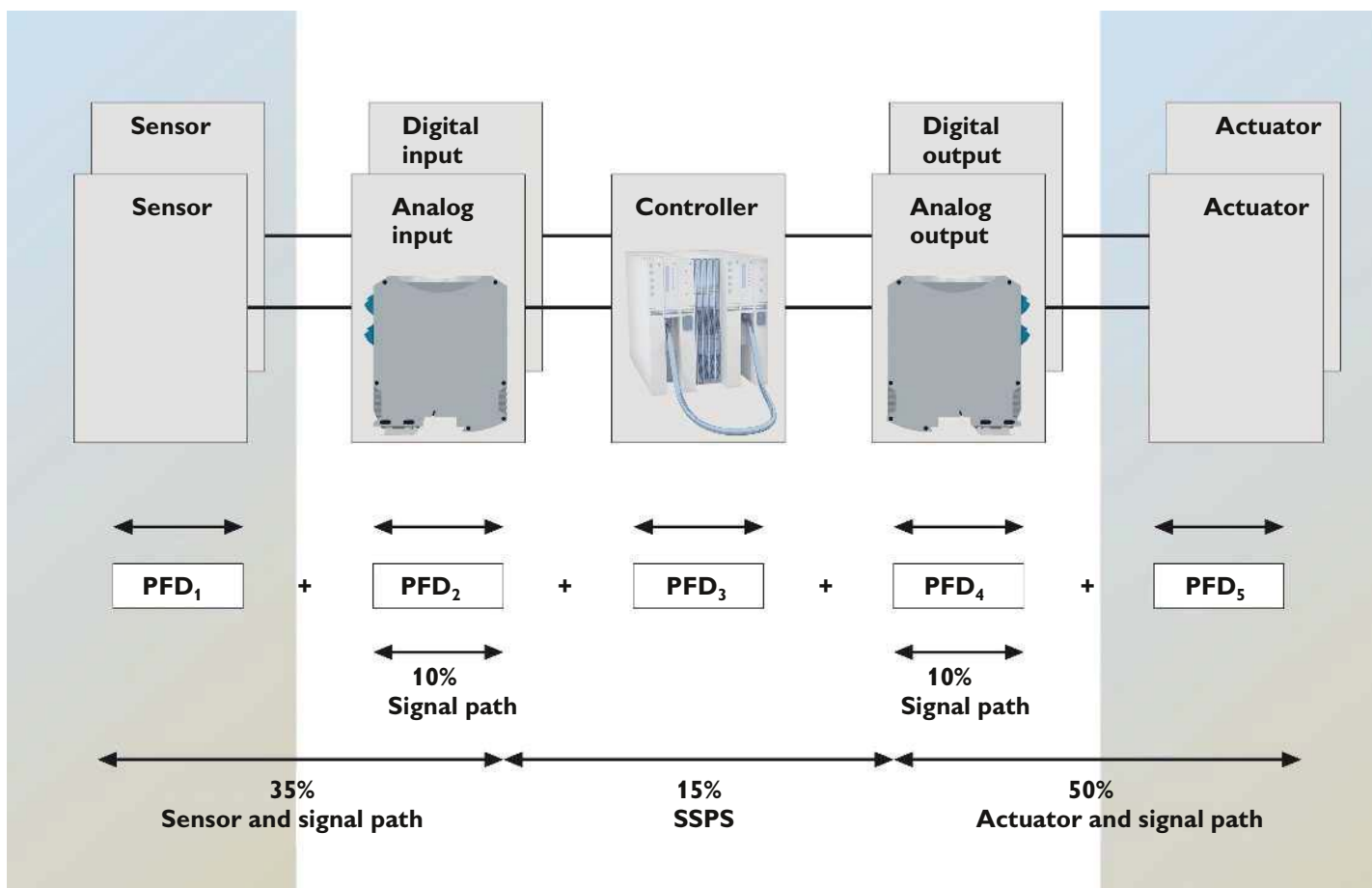

Example of error distribution in a safety-related closed-loop control circuit with low demand rate in accordance with IEC 61508

Analog IN/Analog OUT
3-way signal conditioners

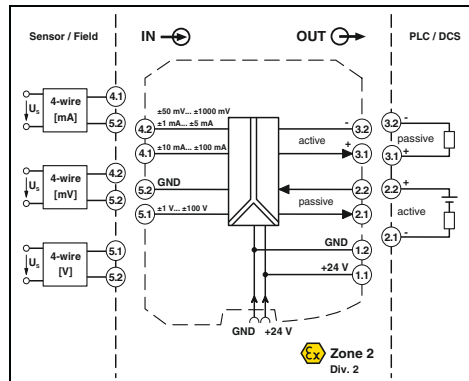
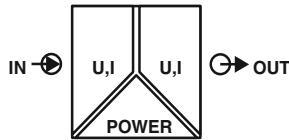

3-way signal conditioner, universal, configurable, over 1600 signal combinations

Functional Safety
Ex: Ex n
Housing width 12.5 mm

Universal signal conditioners for operating 4-conductor measuring transducers.

- Analog signal conditioners for isolating, filtering, amplifying, and converting standard analog signals
- Configurable input and output signals, including bipolar current and voltage signals
- 3-way electrical isolation
- Over 1600 signal conversions can be set via DIP switches on the front
- 10 kHz limit frequency for time-critical applications
- Output active or passive
- Plug-in screw or Push-in connection technology
- Power supply via DIN rail connector possible
- Status indicator for supply voltage
- Up to SIL 2 in accordance with IEC 61508
- Installation in zone 2 permitted

Notes:
To order a product with an order configuration, enter the required configuration by referring to the adjacent order key.
Information about the supply and error evaluation module as well as about the DIN rail connectors and marking material can be found from page 175

Input data	
Input signal (configurable using the DIP switch)	
Maximum input signal	
Input resistance	
Output data	
Output signal (configurable using the DIP switch)	
Load R_B	
General data	
Supply voltage range	
Power dissipation	
Maximum transmission error	
Temperature coefficient	
ZERO / SPAN adjustment	
Limit frequency (3 dB)	
Step response (10-90%)	
Electrical isolation	
Input/output/power supply	2.5 kV (50 Hz, 1 min., test voltage) 300 V _{rms} (rated insulation voltage (overvoltage category II; degree of pollution 2, safe isolation as per EN 61010-1))
Test voltage, input/output/supply	2.5 kV (50 Hz, 1 min.)
Degree of protection	IP20
Ambient temperature (operation)	-20°C ... 70°C
Mounting	any
Housing material	PA 6.6-FR
Dimensions W/H/D	12.5 / 99 / 114.5 mm
Screw connection rigid / flexible / AWG	0.2 ... 2.5 mm ² / 0.2 ... 2.5 mm ² / 24 - 14
Push-in connection rigid / flexible / AWG	0.2 ... 1.5 mm ² / 0.2 ... 1.5 mm ² / 24 - 16
EMC note	
Conformance/approvals	
Conformance	
ATEX	
IECEX	
UL, USA/Canada	
SIL in accordance with IEC 61508	

Technical data

U input	I input
0 ... 10 V, please indicate if different setting when ordering	0 ... 1 mA, configurable via DIP switches
± 100 V	± 100 mA
Approx. 1 MΩ (± 1 V DC ... ± 100 V DC)	Approx. 10 Ω (± 10 mA DC ... ± 100 mA DC)
U output	I output
0 ... 10 V, configurable via DIP switches	0 ... 20 mA, please indicate if different setting when ordering
≥ 1 kΩ (10 V)	≤ 600 Ω (20 mA; active) passive: ≤ (UB-2 V) / I _{outmax}
12 V DC ... 24 V DC (-20% ... +25%)	
< 0.7 W (at 24 V DC / 20 mA)	
≤ 0.1% (compared to the final value)	
0.0075%/K	
± 4% / ± 4%	
10 kHz (can be switched to 30 Hz)	
35 μs (at 10 kHz)	
11 ms (at 30 Hz)	

CE-compliant	
Ex II 3 G Ex nA IIC T4 Gc	
Ex nA IIC T4 Gc	
UL 61010 Listed	
Class I, Div. 2, Groups A, B, C, D T6	
Class I, Zone 2, Group IIC	
2	

Ordering data

Description	Type	Order No.	Pcs./Pkt.
3-way signal conditioner , for electrical isolation of analog signals			
Order configuration	Screw connection	MACX MCR-UI-UI	2811284
Order configuration	Push-in connection	MACX MCR-UI-UI-SP	2811572
Standard configuration	Screw connection	MACX MCR-UI-UI-NC	2811446
Standard configuration	Push-in connection	MACX MCR-UI-UI-SP-NC	2811556

Order key for MACX MCR-UI-UI(-SP) (standard configuration entered as an example)

Order No.	Input	Output	Cut-off frequency	Factory calibration certificate (FCC)
2811284	<p>IN03</p> <p>IN40 ≙ 0 ... 50 mV IN24 ≙ 0 ... 60 mV IN41 ≙ 0 ... 75 mV IN25 ≙ 0 ... 100 mV IN43 ≙ 0 ... 120 mV IN44 ≙ 0 ... 150 mV IN26 ≙ 0 ... 200 mV IN27 ≙ 0 ... 300 mV IN28 ≙ 0 ... 500 mV IN66 ≙ 0 ... 1,000 mV IN29 ≙ 0 ... 1.0 V IN50 ≙ 0 ... 1.5 V IN30 ≙ 0 ... 2.0 V IN52 ≙ 0 ... 3.0 V IN05 ≙ 0 ... 5 V IN03 ≙ 0 ... 10 V IN67 ≙ 0 ... 15 V IN32 ≙ 0 ... 20 V IN39 ≙ 0 ... 30 V IN68 ≙ 0 ... 50 V IN69 ≙ 0 ... 100 V</p> <p>IN06 ≙ 1 ... 5 V IN04 ≙ 2 ... 10 V</p>	<p>OUT01</p> <p>OUT19 ≙ 0 ... 2.5 V OUT05 ≙ 0 ... 5 V OUT03 ≙ 0 ... 10 V</p> <p>OUT20 ≙ -2.5 ... +2.5 V OUT13 ≙ -5 ... +5 V OUT14 ≙ -10 ... +10 V</p> <p>OUT24 ≙ 0.5 ... +2.5 V OUT06 ≙ 1 ... 5 V OUT04 ≙ 2 ... 10 V</p> <p>OUT27 ≙ 2.5 ... 0 V OUT09 ≙ 10 ... 0 V</p>	<p>10K</p> <p>30 ≙ 30 Hz 10K ≙ 10 kHz</p>	<p>NONE</p> <p>NONE ≙ Without FCC YES ≙ With FCC (a fee is charged)</p> <p>YESPLUS ≙ FCC with 5 measuring points (a fee is charged)</p>

Application example: Level measurement and active analog input card

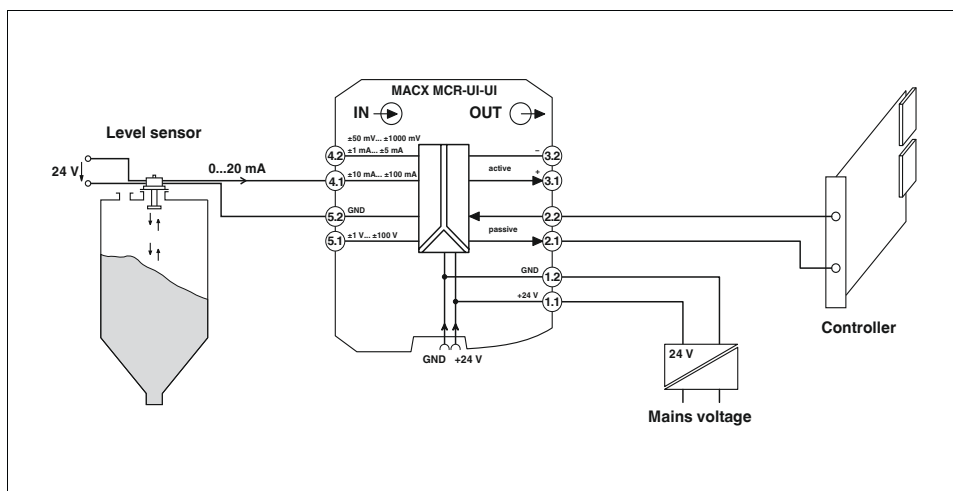

Application example: Shunt measurement and Inline terminal with passive analog input channels within an Inline station

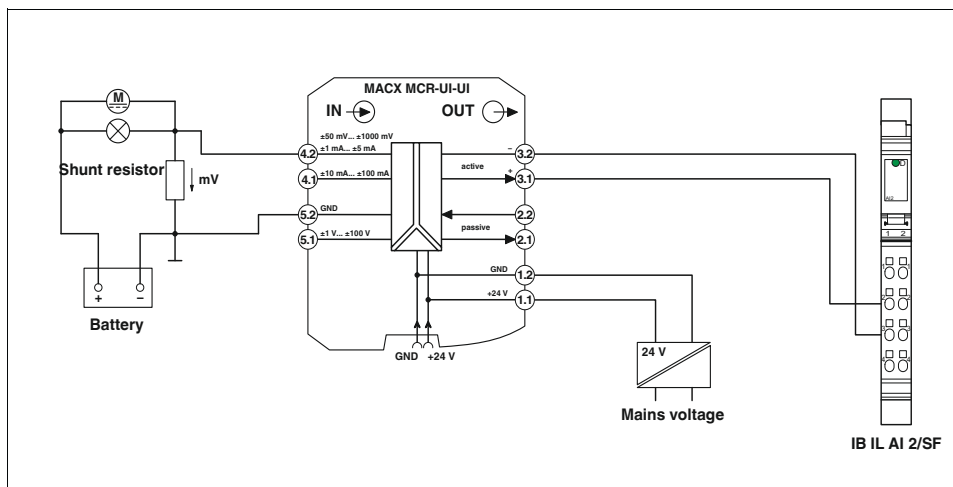

(Information on automation solutions from Phoenix Contact is to be found in Catalog 6 and at phoenixcontact.net/products)

Analog IN/Analog OUT
3-way signal conditioners

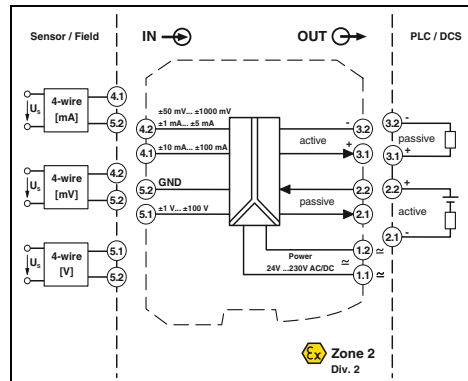
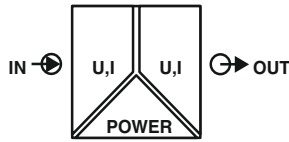

3-way signal conditioner, configurable,
over 1600 signal combinations

DNV GL Functional Safety
Ex: Ex n IEC 61508
Housing width 12.5 mm

- Analog signal conditioners for isolating, filtering, amplifying, and converting standard analog signals
- Configurable input and output signals, including bipolar current and voltage signals
- 3-way electrical isolation
- Over 1600 signal conversions can be set via DIP switches on the front
- Output active or passive
- Plug-in screw or Push-in connection technology
- Wide-range power supply of 19.2 to 253 V AC/DC
- Status indicator for supply voltage
- Up to SIL 2 in accordance with IEC 61508
- Installation in zone 2 permitted

Notes:

To order a product with an order configuration, enter the required configuration by referring to the adjacent order key.

Input data	Input signal (configurable using the DIP switch)
Maximum input signal	± 100 V
Input resistance	Approx. 1 MΩ (± 1 V DC ... ± 100 V DC)
Output data	Output signal (configurable using the DIP switch)
Maximum output signal	15 V
Load R _B	≥ 1 kΩ (10 V)
General data	Supply voltage range Power dissipation
Maximum transmission error	≤ 0.1% (compared to the final value)
Temperature coefficient	0.0075%/K
ZERO / SPAN adjustment	± 4% / ± 4%
Electrical isolation	2.5 kV (50 Hz, 1 min., test voltage) 300 V _{rms} (rated insulation voltage (overvoltage category II; degree of pollution 2, safe isolation as per EN 61010-1))
Degree of protection	IP20
Ambient temperature (operation)	-20°C ... 70°C
Housing material	PA 6.6-FR
Dimensions W/H/D	12.5 / 99 / 114.5 mm
Screw connection rigid / flexible / AWG	0.2 ... 2.5 mm ² / 0.2 ... 2.5 mm ² / 24 - 14
Push-in connection rigid / flexible / AWG	0.2 ... 1.5 mm ² / 0.2 ... 1.5 mm ² / 24 - 16
EMC note	
Conformance/approvals	CE-compliant Ex II 3 G Ex nA IIC T4 Gc 2
Conformance	
ATEX	
SIL in accordance with IEC 61508	

Technical data	
U input	I input
0 ... 10 V, please indicate if different setting when ordering	0 ... 10 V, please indicate if different setting when ordering
0 ... 1 mA, configurable via DIP switches	0 ... 1 mA, configurable via DIP switches
± 100 V	± 100 mA
Approx. 1 MΩ	Approx. 10 Ω
(± 1 V DC ... ± 100 V DC)	(± 10 mA DC ... ± 100 mA DC)
U output	I output
0 ... 10 V, configurable via DIP switches	0 ... 10 V, configurable via DIP switches
0 ... 20 mA, configurable via DIP switches	0 ... 20 mA, configurable via DIP switches
15 V	35 mA
≥ 1 kΩ (10 V)	≤ 600 Ω (20 mA; active) passive: ≤ (UB-2 V) / I _{outmax}
General data	
Supply voltage range	24 V ... 230 V AC/DC (-20%/+10%, 50/60 Hz)
Power dissipation	< 0.8 W (at 24 V DC / 20 mA) < 0.9 W (at 230 V AC / 20 mA)
Maximum transmission error	≤ 0.1% (compared to the final value)
Temperature coefficient	0.0075%/K
ZERO / SPAN adjustment	± 4% / ± 4%
Electrical isolation	2.5 kV (50 Hz, 1 min., test voltage) 300 V _{rms} (rated insulation voltage (overvoltage category II; degree of pollution 2, safe isolation as per EN 61010-1))
Degree of protection	IP20
Ambient temperature (operation)	-20°C ... 70°C
Housing material	PA 6.6-FR
Dimensions W/H/D	12.5 / 99 / 114.5 mm
Screw connection rigid / flexible / AWG	0.2 ... 2.5 mm ² / 0.2 ... 2.5 mm ² / 24 - 14
Push-in connection rigid / flexible / AWG	0.2 ... 1.5 mm ² / 0.2 ... 1.5 mm ² / 24 - 16
EMC note	
Conformance/approvals	CE-compliant Ex II 3 G Ex nA IIC T4 Gc 2
Conformance	
ATEX	
SIL in accordance with IEC 61508	

Description
3-way signal conditioner , for electrical isolation of analog signals with long-range power supply
Order configuration Screw connection
Order configuration Push-in connection
Standard configuration Screw connection
Standard configuration Push-in connection

Ordering data		
Type	Order No.	Pcs./Pkt.
MACX MCR-UI-UI-UP	2811459	1
MACX MCR-UI-UI-UP-SP	2811585	1
MACX MCR-UI-UI-UP-NC	2811297	1
MACX MCR-UI-UI-UP-SP-NC	2811569	1

Order key for MACX MCR-UI-UI(-SP) (standard configuration entered as an example)

Order No.	Input	Output	Cut-off frequency	Factory calibration certificate (FCC)			
2811459	IN03	OUT01	10K	NONE			
2811459 ≙ MACX MCR-UI-UI-UP	IN40 ≙ 0 ... 50 mV IN24 ≙ 0 ... 60 mV IN41 ≙ 0 ... 75 mV IN25 ≙ 0 ... 100 mV IN43 ≙ 0 ... 120 mV IN44 ≙ 0 ... 150 mV IN26 ≙ 0 ... 200 mV IN27 ≙ 0 ... 300 mV IN28 ≙ 0 ... 500 mV IN66 ≙ 0 ... 1,000 mV IN29 ≙ 0 ... 1.0 V IN50 ≙ 0 ... 1.5 V IN30 ≙ 0 ... 2.0 V IN52 ≙ 0 ... 3.0 V IN05 ≙ 0 ... 5 V IN03 ≙ 0 ... 10 V IN67 ≙ 0 ... 15 V IN32 ≙ 0 ... 20 V IN39 ≙ 0 ... 30 V IN68 ≙ 0 ... 50 V IN69 ≙ 0 ... 100 V IN06 ≙ 1 ... 5 V IN04 ≙ 2 ... 10 V	IN53 ≙ -50 ... +50 mV IN13 ≙ -60 ... +60 mV IN54 ≙ -75 ... +75 mV IN14 ≙ -100 ... +100 mV IN56 ≙ -120 ... +120 mV IN57 ≙ -150 ... +150 mV IN15 ≙ -200 ... +200 mV IN16 ≙ -300 ... +300 mV IN17 ≙ -500 ... +500 mV IN78 ≙ -1,000 ... +1,000 mV IN18 ≙ -1.0 ... +1.0 V IN63 ≙ -1.5 ... +1.5 V IN19 ≙ -2.0 ... +2.0 V IN58 ≙ -3.0 ... +3.0 V IN21 ≙ -5 ... +5 V IN22 ≙ -10 ... +10 V IN79 ≙ -15 ... +15 V IN23 ≙ -20 ... +20 V IN80 ≙ -30 ... +30 V IN81 ≙ -50 ... +50 V IN82 ≙ -100 ... +100 V	IN70 ≙ 0 ... 1.0 mA IN71 ≙ 0 ... 1.5 mA IN72 ≙ 0 ... 2.0 mA IN73 ≙ 0 ... 3.0 mA IN36 ≙ 0 ... 5 mA IN37 ≙ 0 ... 10 mA IN74 ≙ 0 ... 15 mA IN01 ≙ 0 ... 20 mA IN75 ≙ 0 ... 30 mA IN76 ≙ 0 ... 50 mA IN77 ≙ 0 ... 100 mA IN83 ≙ -1.0 ... +1.0 mA IN84 ≙ -1.5 ... +1.5 mA IN85 ≙ -2.0 ... +2.0 mA IN86 ≙ -3.0 ... +3.0 mA IN33 ≙ -5 ... +5 mA IN34 ≙ -10 ... +10 mA IN87 ≙ -15 ... +15 mA IN35 ≙ -20 ... +20 mA IN88 ≙ -30 ... +30 mA IN89 ≙ -50 ... +50 mA IN90 ≙ -100 ... +100 mA IN91 ≙ 1 ... 5 mA IN92 ≙ 2 ... 10 mA IN02 ≙ 4 ... 20 mA	OUT19 ≙ 0 ... 2.5 V OUT05 ≙ 0 ... 5 V OUT03 ≙ 0 ... 10 V OUT20 ≙ -2.5 ... +2.5 V OUT13 ≙ -5 ... +5 V OUT14 ≙ -10 ... +10 V OUT24 ≙ 0.5 ... +2.5 V OUT06 ≙ 1 ... 5 V OUT04 ≙ 2 ... 10 V OUT27 ≙ 2.5 ... 0 V OUT09 ≙ 10 ... 0 V	OUT15 ≙ 0 ... 5 mA OUT16 ≙ 0 ... 10 mA OUT01 ≙ 0 ... 20 mA OUT21 ≙ -5 ... +5 mA OUT22 ≙ -10 ... +10 mA OUT23 ≙ -20 ... +20 mA OUT25 ≙ 1 ... 5 mA OUT26 ≙ 2 ... 10 mA OUT02 ≙ 4 ... 20 mA OUT28 ≙ 5 ... 0 mA OUT29 ≙ 10 ... 0 mA OUT07 ≙ 20 ... 0 mA	30 ≙ 30 Hz 10K ≙ 10 kHz	NONE ≙ Without FCC YES ≙ With FCC (a fee is charged) YESPLUS ≙ FCC with 5 measuring points (a fee is charged)

Application example: Level measurement and active analog input card

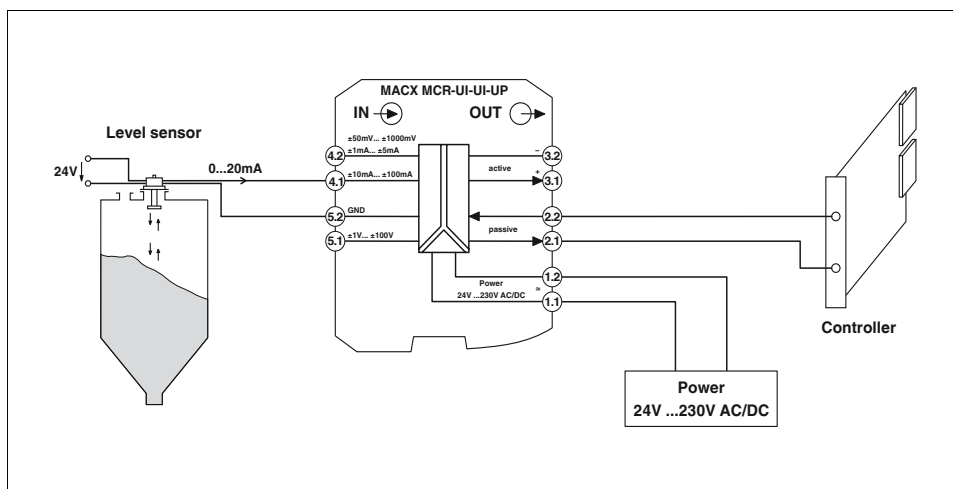

Application example: Shunt measurement and Inline terminal with analog input channels within an Inline station

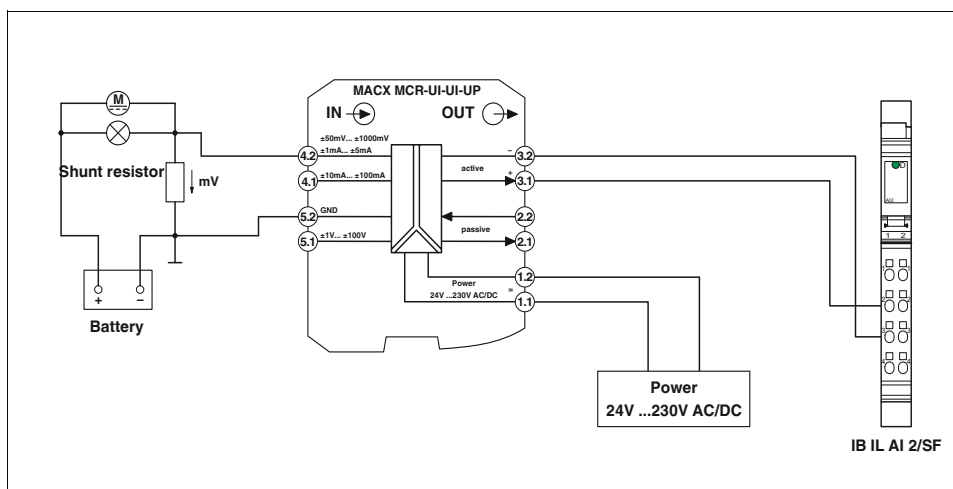

(Information on automation solutions from Phoenix Contact is to be found in Catalog 6 and at phoenixcontact.net/products)

Analog IN / Analog OUT
repeater power supplies

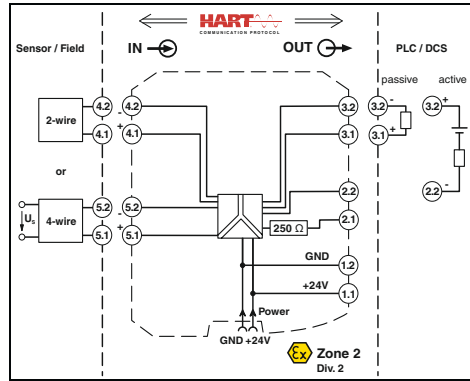
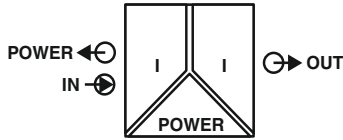

Repeater power supply and input signal conditioner

Functional Safety
Ex: Ex n
Housing width 12.5 mm

Repeater power supply and input signal conditioners for the operation of 2-conductor measuring transducers, 4-conductor measuring transducers, and mA current sources

- 0/4 to 20 mA input (powered or not powered)
- 0/4 to 20 mA output (active or passive)
- Bidirectional transmission of digital HART communication signals
- Plug-in screw or Push-in connection technology, with integrated sockets for HART communicators
- Terminal point with 250 Ω resistor to increase the HART impedance in the case of low-impedance systems
- 3-way electrical isolation
- Power supply via DIN rail connector possible
- Up to SIL 2 in accordance with IEC 61508
- Installation in zone 2 permitted

Notes:
Information about the supply and error evaluation module as well as about the DIN rail connectors and marking material can be found from page 175
Test plugs for test sockets can be found on page 177
Information on "Plug and play" connection using system cabling can be found from page 170

Technical data	
Input data	
Input signal	4 mA ... 20 mA
Transmitter supply voltage	>21.5 V (20 mA)
Voltage drop	<3.5 V (in input signal conditioner operation)
Output data	
Output signal	4 mA ... 20 mA (active) 4 mA ... 20 mA (14 ... 26 V ext. source voltage)
Load	<1,000 Ω (20 mA)
Output ripple	<20 mV _{rms}
General data	
Supply voltage range	19.2 V DC ... 30 V DC (24 V DC -20%...+25%)
Current consumption	<76 mA (24 V DC / 20 mA / 1,000 Ω); <55 mA (24 V DC / 20 mA / 250 Ω)
Power dissipation	<1.1 W (24 V DC / 20 mA) <0.95 W (24 V DC / 20 mA / 250 Ω) <1.2 W (24 V DC / 20 mA / 0 Ω)
Temperature coefficient	<0.01%/K
Step response (10-90%)	<200 μs (for jump 4 mA ... 20 mA, load 600 Ω)
Transmission error, typical	<0.05% (of final value)
Maximum transmission error	<0.1% (of final value)
Under-/overload range	In accordance with NE 43
Electrical isolation	
Input/output/power supply	300 V _{rms} (rated insulation voltage (overvoltage category II); degree of pollution 2, safe isolation as per EN 61010-1) 2.5 kV (50 Hz, 1 min., test voltage)
Ambient temperature range	-20°C ... 60°C (any mounting position)
Status indication	Green LED (supply voltage)
SMART communication	Yes
Signal bandwidth	as per HART specifications
Protocols supported	HART
Housing material	PA 6.6-FR
Dimensions W/H/D	12.5 / 112.5 / 114.5 mm
Screw connection rigid / flexible / AWG	0.2 ... 2.5 mm ² / 0.2 ... 2.5 mm ² / 24 - 14
Push-in connection rigid / flexible / AWG	0.2 ... 1.5 mm ² / 0.2 ... 1.5 mm ² / 24 - 16
Conformance/approvals	
Conformance	CE-compliant, additionally EN 61326
ATEX	Ex II 3 G Ex nA II T4 Gc X
UL, USA/Canada	UL 61010 Listed UL 508 Listed Class I, Div. 2, Groups A, B, C, D T4 Class I, Zone 2, Group IIC T4
SIL in accordance with IEC 61508	2

Ordering data				
Description	Type	Order No.	Pcs./Pkt.	
Repeater power supply, HART®-transparent	Screw connection	MACX MCR-SL-RPSSI-I	2865955	1
	Push-in connection	MACX MCR-SL-RPSSI-I-SP	2924207	1

Analog IN / Analog OUT
repeater power supplies

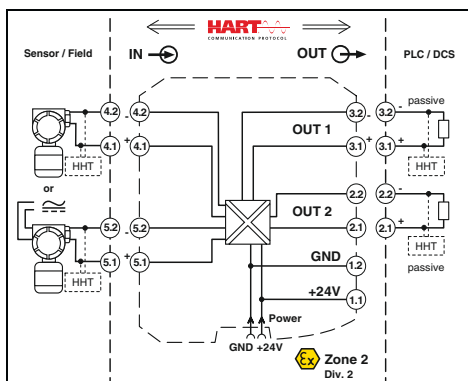
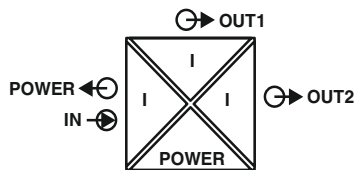

Repeater power supply and input signal conditioner, with two electrically isolated outputs

Functional Safety

Ex: Ex n

Housing width 12.5 mm

Technical data

Input data	
Input signal	4 mA ... 20 mA / 0 mA ... 20 mA
Transmitter supply voltage	>21.5 V (20 mA)
Voltage drop	<3.9 V (in input signal conditioner operation)
Output data	
Output signal (per output)	4 mA ... 20 mA (active) 0 mA ... 20 mA
Load	<450 Ω (20 mA)
Output ripple	<20 mV _{rms}
General data	
Supply voltage range	19.2 V DC ... 30 V DC (24 V DC -20%...+25%)
Current consumption	<75 mA (24 V DC / 20 mA)
Power dissipation	<1.45 W (24 V DC / 20 mA)
Temperature coefficient	<0.01%/K
Step response (10-90%)	1.3 ms (for jump 4 mA ... 20 mA, typical)
Transmission error, typical	<0.05% (of final value)
Maximum transmission error	<0.1% (of final value)
Under-/overload range	In accordance with NE 43
Electrical isolation	
	Input/output/power supply
	300 V _{rms} (rated insulation voltage (overvoltage category II; degree of pollution 2, safe isolation as per EN 61010-1)) 2.5 kV (50 Hz, 1 min., test voltage)
	Output 1/output 2
	1.5 kV AC (50 Hz, 1 min., test voltage) -20°C ... 60°C (any mounting position) -20°C ... 70°C (any mounting position, module distance > 5 mm, MTBF reduction factor 2.5, not assessed by UL)
Ambient temperature range	
Status indication	Green LED (PWR supply voltage)
SMART communication (per output)	Yes
Protocols supported	HART
Housing material	PA 6.6-FR
Dimensions W/H/D	12.5 / 112.5 / 114.5 mm
Screw connection rigid / flexible / AWG	0.2 ... 2.5 mm ² / 0.2 ... 2.5 mm ² / 24 - 14
Push-in connection rigid / flexible / AWG	0.2 ... 1.5 mm ² / 0.2 ... 1.5 mm ² / 24 - 16
Conformance/approvals	
Conformance	CE-compliant, additionally EN 61326-1
ATEX	Ex II 3 G Ex nA IIC T4 Gc X
SIL in accordance with IEC 61508	2

- Repeater power supply and input signal conditioners for the operation of 2-conductor measuring transducers, 4-conductor measuring transducers, and mA current sources
- 0/4 to 20 mA input (powered or not powered)
- Two electrically isolated outputs, 0/4 to 20 mA (active)
- Bidirectional transmission of digital HART communication signals (both outputs)
- Plug-in screw or Push-in connection technology, with integrated sockets for HART communicators
- 4-way electrical isolation
- Power supply via DIN rail connector possible
- Up to SIL 2 in accordance with IEC 61508
- PL d in accordance with EN ISO 13849-1
- Installation in zone 2 permitted

Notes:
Information about the supply and error evaluation module as well as about the DIN rail connectors and marking material can be found from page 175
Test plugs for test sockets can be found on page 177
Information on "Plug and play" connection using system cabling can be found from page 170

Description
Repeater power supply, HART®-transparent
Screw connection
Push-in connection

Ordering data

Type	Order No.	Pcs./Pkt.
MACX MCR-SL-RPSSI-2I	2924825	1
MACX MCR-SL-RPSSI-2I-SP	2924838	1

Analog IN / Analog OUT
repeater power supplies

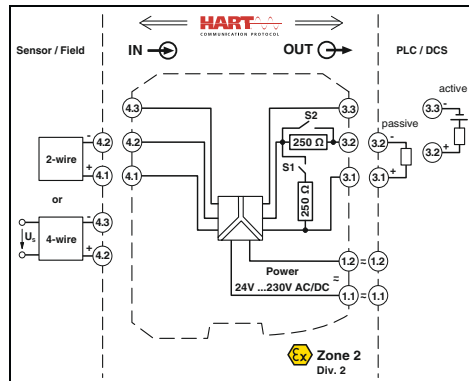
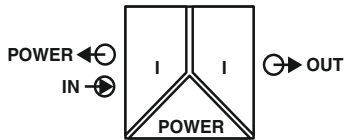

Repeater power supply and input signal conditioner, wide-range power supply

Functional Safety

Ex:

Housing width 17.5 mm

Repeater power supply and input signal conditioner for the operation of 2-conductor measuring transducers, 4-conductor measuring transducers, and mA current sources

- 0/4 to 20 mA input (powered or not powered)
- 0/4 to 20 mA output (active or passive), 0/1 to 5 V, can be selected via DIP switch
- Bidirectional transmission of digital HART communication signals
- Plug-in screw or Push-in connection technology, with integrated sockets for HART communicators
- 250 Ω resistor that can be activated via DIP switches to increase the HART impedance in the case of low-impedance systems
- 3-way electrical isolation
- Wide-range power supply of 19.2 to 253 V AC/DC
- Up to SIL 2 in accordance with IEC 61508
- Installation in zone 2 permitted

Notes:
Information about the supply and error evaluation module as well as about the DIN rail connectors and marking material can be found from page 175
Test plugs for test sockets can be found on page 177

Input data	Input signal Transmitter supply voltage Voltage drop
Output data	Output signal
Load	Output ripple
General data	Supply voltage range Current consumption Power dissipation Temperature coefficient Step response (10-90%) Transmission error, typical Maximum transmission error Under-/overload range Electrical isolation
Ambient temperature range	Status indication SMART communication Signal bandwidth Protocols supported Housing material Dimensions W/H/D Screw connection rigid / flexible / AWG Push-in connection rigid / flexible / AWG Conformance/approvals
Conformance	ATEX UL, USA/Canada
SIL in accordance with IEC 61508	

Technical data		
Input signal	4 mA ... 20 mA	
Transmitter supply voltage	>16 V (20 mA)	
Voltage drop	<3.5 V (in input signal conditioner operation)	
Output signal	4 mA ... 20 mA (active) 4 mA ... 20 mA (14 ... 26 V ext. source voltage) 1 V ... 5 V (internal resistance, 250 Ω, 0.1%) Configurable via DIP switches	
Output ripple	<600 Ω (20 mA) <20 mV _{rms}	
Supply voltage range	19.2 V AC/DC ... 253 V AC/DC (24 V AC/DC ... 230 V AC/DC (-20% ... +10%, 50/60 Hz))	
Current consumption	<75 mA (24 V DC / 20 mA)	
Power dissipation	<1.6 W (24 V DC/ 20 mA)	
Temperature coefficient	<0.01%/K	
Step response (10-90%)	<600 μs (for 4 mA ... 20 mA step)	
Transmission error, typical	<0.05% (of final value)	
Maximum transmission error	<0.1% (of final value)	
Under-/overload range	In accordance with NE 43	
Electrical isolation	300 V _{rms} (rated insulation voltage (overvoltage category II; degree of pollution 2, safe isolation as per EN 61010-1)) 2.5 kV (50 Hz, 1 min., test voltage)	
Ambient temperature range	-20°C ... 60°C (any mounting position)	
Status indication	Green LED (supply voltage)	
SMART communication	Yes	
Signal bandwidth	as per HART specifications	
Protocols supported	HART	
Housing material	PA 6.6-FR	
Dimensions W/H/D	17.5 / 112.5 / 114.5 mm	
Screw connection rigid / flexible / AWG	0.2 ... 2.5 mm ² / 0.2 ... 2.5 mm ² / 24 - 14	
Push-in connection rigid / flexible / AWG	0.2 ... 1.5 mm ² / 0.2 ... 1.5 mm ² / 24 - 16	
Conformance/approvals	CE-compliant, additionally EN 61326-1 II 3 G Ex nA IIC T4 Gc X UL 508 Listed UL 61010 Listed Class I, Div. 2, Groups A, B, C, D T4 Class I, Zone 2, Group IIC T4 2	

Ordering data				
Description	Type	Order No.	Pcs./Pkt.	
Repeater power supply, HART®-transparent	Screw connection	MACX MCR-SL-RPSSI-I-UP	2865968	1
	Push-in connection	MACX MCR-SL-RPSSI-I-UP-SP	2924210	1

Analog IN / Analog OUT
repeater power supplies

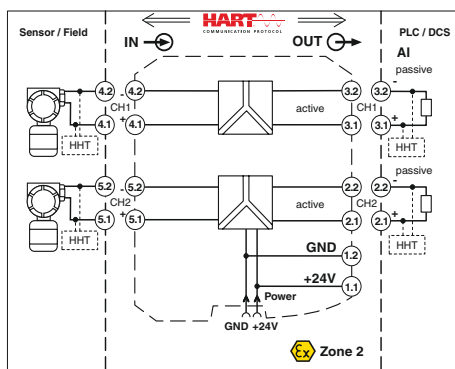
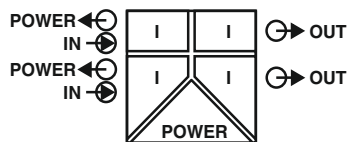

2-channel repeater power supply

Repeater power supply for the operation of 2-conductor measuring transducers.

- 2-channel
- Input: 4 to 20 mA (powered)
- Output: 4 to 20 mA (active)
- Bidirectional transmission of digital HART communication signals
- Plug-in screw or Push-in connection technology, with integrated sockets for HART communicators
- Safe 3-way electrical isolation
- Power supply via DIN rail connector possible
- Up to SIL 3 in accordance with IEC 61508
- PL d in accordance with EN ISO 13849-1
- Installation in zone 2 permitted

Notes:
Information about the supply and error evaluation module as well as about the DIN rail connectors and marking material can be found from page 175
Test plugs for test sockets can be found on page 177
Information on "Plug and play" connection using system cabling can be found from page 170

Input data	
Input signal	
Transmitter supply voltage	
Underload/overload signal range	
Output data	
Output signal	
Load	
Underload/overload signal range	
General data	
Supply voltage range	
Current consumption	
Power dissipation	
Temperature coefficient	
Step response (10-90%)	
Transmission error, typical	
Maximum transmission error	
Electrical isolation	
Input/output, power supply	
Output 1/output 2/ power supply	
Ambient temperature range	
Status indication	
SMART communication	
Signal bandwidth	
Protocols supported	
Housing material	
Dimensions W/H/D	
Screw connection rigid / flexible / AWG	
Push-in connection rigid / flexible / AWG	
Conformance/approvals	
Conformance	
ATEX	
UL, USA/Canada	
SIL in accordance with IEC 61508	
Systematic Capability	

Functional Safety

Ex:

Housing width 12.5 mm

Technical data

per channel	
4 mA ... 20 mA	
>16 V (at 20 mA)	
0 mA ... 24 mA	
per channel	
4 mA ... 20 mA (active)	
≤450 Ω (20 mA)	
0 mA ... 24 mA	
19.2 V DC ... 30 V DC (24 V DC -20%...+25%)	
<100 mA (24 V / 20 mA)	
<1.4 W (at 24 V DC / 20 mA)	
<0.01%/K	
<1.3 ms (for 4 mA ... 20 mA step)	
<0.05% (of final value)	
<0.1% (of final value)	
300 V _{rms} (rated insulation voltage (overvoltage category II; degree of pollution 2, safe isolation as per EN 61010-1))	
2.5 kV (50 Hz, 1 min., test voltage)	
1.5 kV (50 Hz, 1 min., test voltage)	
-20°C ... 60°C (any mounting position)	
Green LED (supply voltage)	
Yes	
as per HART specifications	
HART	
PA 6.6-FR	
12.5 / 112.5 / 114.5 mm	
0.2 ... 2.5 mm ² / 0.2 ... 2.5 mm ² / 24 - 14	
0.2 ... 1.5 mm ² / 0.2 ... 1.5 mm ² / 24 - 16	
CE-compliant, additionally EN 61326	
II 3 G Ex nA IIC T4 Gc X	
UL 61010 Listed	
Class I, Div. 2, Groups A, B, C, D T4	
Class I, Zone 2, Group IIC T4	
2	
3	
SC 3	

Ordering data

Description	Type	Order No.	Pcs./Pkt.
Repeater power supply, 2-channel, HART®-transparent			
Screw connection	MACX MCR-SL-RPSS-2I-2I	2904089	1
Push-in connection	MACX MCR-SL-RPSS-2I-2I-SP	2904090	1

Analog IN / Analog OUT passive isolators

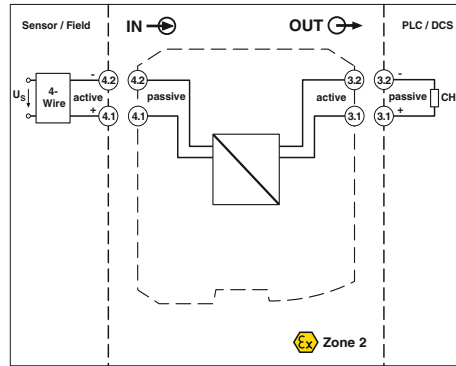
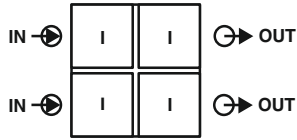

Passive isolator, one and two channel



Ex:

Housing width 12.5 mm

The single- or dual-channel input loop-powered 2-way isolator with increased isolation voltage and plug-in connection technology is used for the electrical isolation and filtering of analog signals.

The device allows operation on active sensor technology with a supply voltage of 6 to 30 V DC.

The device is powered via the current loop of the sensor. As a result, no additional power supply is required.

Input data

Max. voltage input signal
Input signal
Input voltage limitation
Voltage dissipation
Response current

Output data

Max. voltage output signal
Output signal
Residual ripple
Transmission Behavior
Load

General data

Supply voltage range

Temperature coefficient
Maximum transmission error
Electrical isolation

Input/output/power supply

Ambient temperature range
Humidity
Degree of protection
Inflammability class in accordance with UL 94
Housing material
Dimensions W/H/D
Screw connection rigid / flexible / AWG
Push-in connection rigid / flexible / AWG

Conformance/approvals

Conformance
ATEX
UL, USA/Canada

SIL in accordance with IEC 61508

Technical data

<30.5 V
0 mA ... 20 mA / 4 mA ... 20 mA
30.5 V
2.9 V (I = 20 mA)
Approx. 50 µA

27.5 V
0 mA ... 20 mA / 4 mA ... 20 mA
<10 mV_{rms} (500 Ω load)
1:1 to input signal
≤1375 Ω (I = 20 mA)

no separate supply voltage necessary

≤0.002%/K (of measured value / 100 Ω load)
≤0.1% (of final value)

300 V_{rms} (rated insulation voltage (overvoltage category II; degree of pollution 2, safe isolation as per EN 61010-1))
2.5 kV (50 Hz, 1 min., test voltage)

-40°C ... 85°C
5% ... 95% (non-condensing)
IP20
V0
PA 6.6-FR
12.5 / 99 / 114.5 mm
0.2 ... 2.5 mm² / 0.2 ... 2.5 mm² / 24 - 14
0.2 ... 1.5 mm² / 0.2 ... 1.5 mm² / 24 - 16

CE-compliant, additionally EN 61326-1
 II 3 G Ex nA IIC T4 Gc X
UL 61010 Listed
Class I, Div. 2, Groups A, B, C, D T4
Class I, Zone 2, Group IIC T4
3

Ordering data

Description

Passive isolator, one or two channel

Screw connection
Push-in connection
Screw connection
Push-in connection

Type

MACX MCR-SL-I-I-ILP
MACX MCR-SL-I-I-ILP-SP
MACX MCR-SL-2I-2I-ILP
MACX MCR-SL-2I-2I-ILP-SP

Order No.

2905278
2905279
2905280
2905281

Pcs./Pkt.

1
1
1
1

Analog IN / Analog OUT
passive isolators

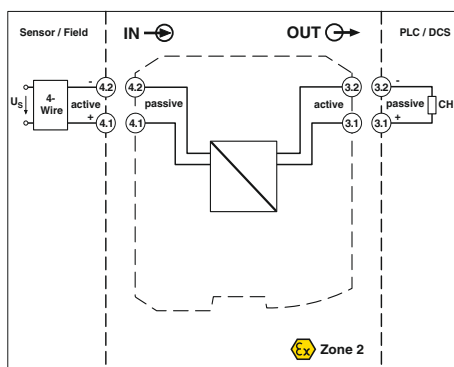
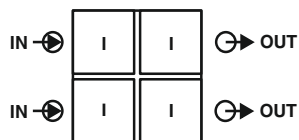

Ex n



Passive isolator, one and two channel
5 kV test voltage



Ex:
Housing width 12.5 mm

Technical data

Input data	
Max. voltage input signal	<30.5 V
Input signal	0 mA ... 20 mA / 4 mA ... 20 mA
Input voltage limitation	30.5 V
Voltage dissipation	2.9 V (I = 20 mA)
Response current	Approx. 50 µA
Output data	
Max. voltage output signal	27.5 V
Output signal	0 mA ... 20 mA / 4 mA ... 20 mA
Residual ripple	<10 mV _{rms} (500 Ω load)
Transmission Behavior	1:1 to input signal
Load	≤1375 Ω (I = 20 mA)
General data	
Supply voltage range	no separate supply voltage necessary
Temperature coefficient	≤0.002%/K (of measured value / 100 Ω load)
Maximum transmission error	≤0.1% (of final value)
Electrical isolation	
Input/output/power supply	600 V _{rms} (rated insulation voltage (overvoltage category II; degree of pollution 2, safe isolation as per EN 61010-1)) 5 kV (50 Hz, 1 min., test voltage)
Ambient temperature range	-40°C ... 85°C
Humidity	5% ... 95% (non-condensing)
Degree of protection	IP20
Inflammability class in accordance with UL 94	V0
Housing material	PA 6.6-FR
Dimensions W/H/D	12.5 / 99 / 114.5 mm
Screw connection rigid / flexible / AWG	0.2 ... 2.5 mm ² / 0.2 ... 2.5 mm ² / 24 - 14
Push-in connection rigid / flexible / AWG	0.2 ... 1.5 mm ² / 0.2 ... 1.5 mm ² / 24 - 16
Conformance/approvals	
Conformance	CE-compliant, additionally EN 61326-1
ATEX	II 3 G Ex nA IIC T4 Gc X
UL, USA/Canada	UL 61010 Listed Class I, Div. 2, Groups A, B, C, D T4 Class I, Zone 2, Group IIC T4
SIL in accordance with IEC 61508	3

Ordering data

Description	Type	Order No.	Pcs./Pkt.	
Passive isolator, one or two channel	Screw connection	MACX MCR-SL-I-I-HV-ILP	2907704	1
	Push-in connection	MACX MCR-SL-I-I-HV-ILP-SP	2907705	1
	Screw connection	MACX MCR-SL-2I-2I-HV-ILP	2907706	1
	Push-in connection	MACX MCR-SL-2I-2I-HV-ILP-SP	2907707	1

Temperature, temperature transducers

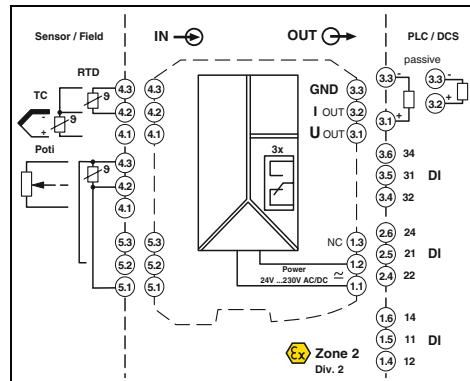
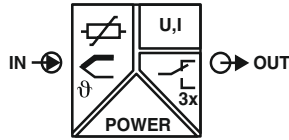

Temperature transducer, universal, with three limit value relays, wide range supply

Functional Safety

Ex: Ex n

Housing width 35 mm

Universal temperature transducers with freely configurable properties

- Input for resistance thermometers, thermocouples, resistance-type sensors, potentiometers, and mV sources
- Measure differential temperatures
- Freely programmable input and output
- Option of inverse output signal ranges
- Three limit value relays, can be used in combination as a safe limit value relay
- Configuration via software (FDT-DTM)
- Programming during operation and also voltage-free using IFS-USB-PROG-ADAPTER programming adapter
- Plug-in screw or Push-in connection technology
- Cold junction compensation with separate connector
- Wide-range power supply of 19.2 to 253 V AC/DC
- Status indicator for supply voltage, cable, sensor, and module errors
- Up to SIL 2 in accordance with IEC 61508
- PL d in accordance with EN ISO 13849-1
- Installation in zone 2 permitted

Notes:
 The configuration software can be downloaded from the Internet (phoenixcontact.net/products).
 For information on the programming adapter, refer to page 173

Input data	Resistance thermometers Thermocouple sensors
Resistor	Potentiometer
Voltage	
Output data	
Output signal	
Maximum output signal	
Load R_B	
Behavior in the event of a sensor error	
Switching output	
Contact type	
Contact material	
Max. switching voltage	
Maximum switching current	
General data	
Supply voltage range	
Power consumption	
Temperature coefficient	
Maximum transmission error	
Electrical isolation	
	Input/output/power supply
	Input/output
	Input/power supply
	Input/switching output
Ambient temperature range	
Humidity	
Inflammability class in accordance with UL 94	
Housing material	
Dimensions W/H/D	
Screw connection rigid / flexible / AWG	
Push-in connection rigid / flexible / AWG	
Conformance/approvals	
Conformance	
ATEX	
IECEX	
UL, USA/Canada	
SIL in accordance with IEC 61508	

Technical data		
Pt, Ni, Cu sensors: 2-, 3-, 4-conductor		
B, E, J, K, N, R, S, T, L, U, CA, DA, A1G, A2G, A3G, MG, LG		
0 Ω ... 50 kΩ		
0 Ω ... 50 kΩ		
-1,000 mV ... 1,000 mV		
U output	I output	
4 mA ... 20 mA (in the case of SIL; further free configuration without SIL)		
± 11 V	22 mA	
≥ 10 kΩ	≤ 600 Ω (at 20 mA)	
In accordance with NE 43 or freely configurable		
Relay output		
3 PDTs		
AgSnO ₂ , hard gold-plated		
250 V AC (250 V DC)		
2 A (250 V AC) / 2 A (28 V DC)		
24 V ... 230 V AC/DC (-20%/+10%, 50/60 Hz)		
< 2.4 W		
0.01%/K		
0.1% (e.g. for Pt 100, 300 K span, 4 ... 20 mA)		
300 V _{rms} (rated insulation voltage (overvoltage category II; degree of pollution 2, safe isolation as per EN 61010-1))		
2.5 kV (50 Hz, 1 min., test voltage)		
375 V (peak value in accordance with EN 60079-11)		
375 V (peak value in accordance with EN 60079-11)		
375 V (peak value in accordance with EN 60079-11)		
-20°C ... 65°C		
Typically 5% ... 95% (non-condensing)		
V0		
PA 6.6-FR		
35 / 99 / 114.5 mm		
0.2 ... 2.5 mm ² / 0.2 ... 2.5 mm ² / 24 - 14		
0.2 ... 1.5 mm ² / 0.2 ... 1.5 mm ² / 24 - 16		
CE-compliant		
Ex II 3 G Ex nA nC ic IIC T4 Gc X		
Ex nA nC ic IIC T4 Gc X		
UL 508 Listed		
Class I, Div. 2, Groups A, B, C, D T6		
Class I, Zone 2, Group IIC T6		
2		

Ordering data			
Description	Type	Order No.	Pcs./Pkt.
Temperature transducer			
Standard configuration	Screw connection	MACX MCR-T-UIREL-UP	2811378 1
Standard configuration	Push-in connection	MACX MCR-T-UIREL-UP-SP	2811828 1
Order configuration	Screw connection	MACX MCR-T-UIREL-UP-C	2811514 1
Order configuration	Push-in connection	MACX MCR-T-UIREL-UP-SP-C	2811831 1
Accessories			
Programming adapter for configuring modules with S-PORT interface		IFS-USB-PROG-ADAPTER	2811271 1
Cold junction compensation connector for thermocouples		MACX MCR-CJC	2924993 1

MACX Analog – Signal conditioners with functional safety

Order key for MACX MCR-T-UIREL-UP-(SP)-C temperature transducers (standard configuration entered as an example)

Order No.	SIL	Measuring unit	Sensor type	Connection technology	Measuring range:		Output signal	Switching function 1	Lower switching point 1	Upper switching point 1	Switching function 2	Lower switching point 2	Upper switching point 2	Factory calibration certificate
					Start	End								
2811514	ON	C	PT100	4	-50	150	OUT02	0	99999	99999	0	99999	99999	NONE
2811514 ≙ MACX MCR-T-UIREL-UP-C	ON ≙ Active NONE ≙ Not active ON only with output range = OUT02	Celsius [C] Ω [O] Millivolts [V]	See below	2 ≙ 2-conductor 3 ≙ 3-conductor 4 ≙ 4-conductor	See below	See below	0...20 mA [OUT01] 4...20 mA [OUT02] 0...10 V [OUT03] 2...10 V [OUT04] 0...5 V [OUT05] 1...5 V [OUT06] -5...+5 V [OUT13] -10...+10 V [OUT14] 0...5 mA [OUT15] 0...10 mA [OUT16] 1...5 mA [OUT25] 2...10 mA [OUT26]	L [0] H [1] L → SPH → H [2] H → SPH → L [3] L → SPH → H → SPL → L [4] H → SPH → L → SPL → H [5] L → SPL → H → SPH → L [6] H → SPL → L → SPH → H [7]	Free input, see web site for more	Free input, see web site for more		Free input, see web site for more	Free input, see web site for more	NONE ≙ Without FCC YES ≙ With FCC (a fee is charged) YESPLUS ≙ FCC with 5 measuring points (a fee is charged)

Resistance temperature detector (RTD)

°C	PT50	≙ Pt 50 IEC60751	-200	850	20k
°C	PT100	≙ Pt 100 IEC60751	-200	850	20k
°C	PT200	≙ Pt 200 IEC60751	-200	850	20k
°C	PT500	≙ Pt 500 IEC60751	-200	850	20k
°C	PT1000	≙ Pt 1000 IEC60751	-200	850	20k
°C	PT2000	≙ Pt 2000 IEC60751	-200	850	20k
°C	PT5000	≙ Pt 5000 IEC60751	-200	850	20k
°C	PT50S	≙ PT50 SAMA RC21-4-1966	-200	850	20k
°C	PT100S	≙ PT100 SAMA RC21-4-1966	-200	850	20k
°C	PT200S	≙ PT200 SAMA RC21-4-1966	-200	850	20k
°C	PT500S	≙ PT500 SAMA RC21-4-1966	-200	850	20k
°C	PT1000S	≙ PT1000 SAMA RC21-4-1966	-200	850	20k
°C	PT2000S	≙ PT2000 SAMA RC21-4-1966	-200	850	20k
°C	PT5000S	≙ PT5000 SAMA RC21-4-1966	-200	850	20k
°C	PT100G	≙ PT100 G GOST 6651-2009 (α=0.00391)	-200	850	20k
°C	PT200G	≙ PT200 G GOST 6651-2009 (α=0.00391)	-200	850	20k
°C	PT500G	≙ PT500 G GOST 6651-2009 (α=0.00391)	-200	850	20k
°C	PT1000G	≙ PT1000 G GOST 6651-2009 (α=0.00391)	-200	850	20k
°C	PT100J	≙ Pt 100 JIS C1604/1997	-200	850	20k
°C	PT200J	≙ Pt 200 JIS C1604/1997	-200	850	20k
°C	PT500J	≙ Pt 500 JIS C1604/1997	-200	850	20k
°C	PT1000J	≙ Pt 1000 JIS C1604/1997	-200	850	20k
°C	Ni100	≙ Ni100 DIN 43760	-60	250	20k
°C	Ni200	≙ Ni200 DIN 43760	-60	250	20k
°C	Ni500	≙ Ni500 DIN 43760	-60	250	20k
°C	Ni1000	≙ Ni1000 DIN 43760	-60	250	20k
°C	Ni100S	≙ Ni100 SAMA RC21-4-1966	-60	180	20k
°C	Ni200S	≙ Ni200 SAMA RC21-4-1966	-60	180	20k
°C	Ni500S	≙ Ni500 SAMA RC21-4-1966	-60	180	20k
°C	Ni1000S	≙ Ni1000 SAMA RC21-4-1966	-60	180	20k
°C	Ni1000L	≙ Ni1000 Landis&Gyr	-50	160	20k
°C	CU10	≙ CU10 SAMA RC21-4-1966	-70	500	20k
°C	CU50	≙ CU 50 GOST 6651-2009 (α=0.00428)	-50	200	20k
°C	CU100	≙ CU 100 GOST 6651-2009 (α=0.00428)	-50	200	20k
°C	CU53	≙ CU 53 GOST 6651-2009 (α=0.00426)	-50	180	20k
°C	KTY81	≙ KTY81 KTY81-110 (Philips)	-55	150	20k
°C	KTY84	≙ KTY81 KTY84-130 (Philips)	-40	300	20k

Smallest measuring range span

Other setting options can be configured with the IFS-CONF software:

- Freely configurable user characteristic curve with 30 support points
- Output behavior in the event of a short circuit, sensor break or overrange/underrange can be freely configured or set in accordance with NE43 (standard configuration: NE43 upscale)
- Filter setting (standard configuration: 1)
- Restart after failsafe (standard configuration: ON)
- Switching behavior: switching output (limit values, times, etc.) (standard configuration: OFF)

Thermocouples (TC)

°C	A1G	≙ A-1 GOST 8.585-2001	0	2,500	50k
°C	A2G	≙ A-2 GOST 8.585-2001	0	1,800	50k
°C	A3G	≙ A-3 GOST 8.585-2001	0	1,800	50k
°C	B	≙ B IEC584-1 (Pt30Rh-Pt6Rh)	500	1,820	50k
°C	C	≙ C ASTM E988	0	2,315	50k
°C	D	≙ DA ASTM E988(2002)	0	2,315	50k
°C	E	≙ E IEC584-1 (NiCr-CuNi)	-230	1,000	50k
°C	J	≙ J IEC584-1 (Fe-CuNi)	-210	1,200	50k
°C	K	≙ K IEC584-1 (NiCr-Ni)	-250	1,372	50k
°C	MG	≙ MG GOST 8.585-2001	-200	100	50k
°C	N	≙ N IEC 584-1 (NiCrSi-NiSi)	-200	1,300	50k
°C	R	≙ R IEC 584-1 (Pt13Rh-Pt)	-50	1,768	50k
°C	S	≙ S IEC 584-1 (Pt10Rh-Pt)	-50	1,768	50k
°C	T	≙ T IEC 584-1 (Cu-CuNi)	-200	400	50k
°C	L	≙ L DIN 43760 (Fe-CuNi)	-200	900	50k
°C	LG	≙ LG GOST 8.585-2001	-200	800	50k
°C	U	≙ U DIN 43760 (Cu-CuNi)	-200	600	50k

Remote resistance-type sensors (R) (2-, 3-, 4-conductor)

Ω	RES12	≙ Resistance 0...50,000 Ω For more values, visit www.phoenixcontact.com	0	50,000	10% of the selected measuring range
---	-------	--	---	--------	-------------------------------------

Potentiometers (3-conductor)

Ω	POT12	≙ Potentiometer 0...50,000 Ω For more values, visit www.phoenixcontact.com	0	50,000	10% of the selected measuring range
---	-------	---	---	--------	-------------------------------------

Voltage signals (mV)

mV	V04	≙ Voltage -1,000 mV...+1,000 mV For more values, visit www.phoenixcontact.com	-1,000	1,000	10% of nominal span
----	-----	--	--------	-------	---------------------

Temperature conversion guide for °C to °F:

$$T [°F] = \frac{9}{5} T [°C] + 32$$

Temperature, temperature transducers

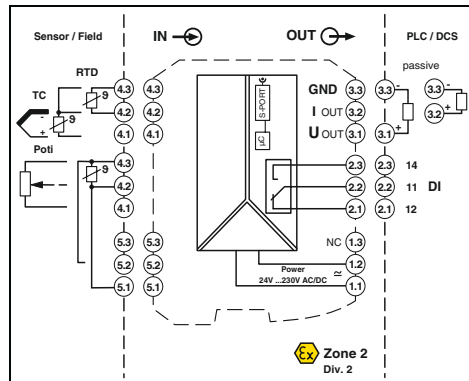
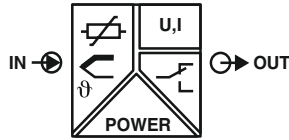

Temperature transducer, universal, with switching output, wide range supply

Functional Safety
 Ex: Ex n IEC 61508
 Housing width 17.5 mm

Universal temperature transducers with freely configurable properties

- Input for resistance thermometers, thermocouples, resistance-type sensors, potentiometers, and mV sources
- Measure differential temperatures
- Freely programmable input and output
- Option of inverse output signal ranges
- Relay switching output
- Configuration via software (FDT-DTM)
- Programming during operation and also voltage-free using IFS-USB-PROG-ADAPTER programming adapter
- Plug-in screw or Push-in connection technology
- Cold junction compensation with separate connector
- Wide-range power supply of 19.2 to 253 V AC/DC
- Status indicator for supply voltage, cable, sensor, and module errors
- Up to SIL 2 in accordance with IEC 61508
- Installation in zone 2 permitted

Notes:
To order a product with an order configuration, enter the required configuration by referring to the adjacent order key.
The configuration software can be downloaded from the Internet (phoenixcontact.net/products).
For information on the programming adapter, refer to page 173

Input data	Resistance thermometers Thermocouple sensors
Resistor	Potentiometer
Output data	Output signal
Maximum output signal	Load R_B
Behavior in the event of a sensor error	Switching output
Switching output	Contact type Contact material Max. switching voltage Maximum switching current
General data	Supply voltage range Power consumption Temperature coefficient Transmission error, total Electrical isolation
Ambient temperature range	Humidity
Inflammability class in accordance with UL 94	Housing material
Dimensions W/H/D	Screw connection rigid / flexible / AWG Push-in connection rigid / flexible / AWG
Conformance/approvals	Conformance ATEX IECEX SIL in accordance with IEC 61508
Input/output/power supply	300 V _{rms} (rated insulation voltage (overvoltage category II; degree of pollution 2, safe isolation as per EN 61010-1)) 2.5 kV (50 Hz, 1 min., test voltage)
Input/output	375 V (peak value in accordance with EN 60079-11)
Input/power supply	375 V (peak value in accordance with EN 60079-11)
Input/switching output	375 V (peak value in accordance with EN 60079-11) -20°C ... 65°C Typically 5% ... 95% (non-condensing) V0 PA 6.6-FR 17.5 / 99 / 114.5 mm 0.2 ... 2.5 mm ² / 0.2 ... 2.5 mm ² / 24 - 14 0.2 ... 1.5 mm ² / 0.2 ... 1.5 mm ² / 24 - 16

Technical data

Pt, Ni, Cu sensors: 2-, 3-, 4-conductor
 B, E, J, K, N, R, S, T, L, U, CA, DA, A1G, A2G, A3G, MG, LG

0 Ω ... 50 kΩ
 0 Ω ... 50 kΩ
 -1,000 mV ... 1,000 mV

U output I output
 4 mA ... 20 mA (in the case of SIL; further free configuration without SIL)

± 11 V 22 mA
 ≥ 10 kΩ ≤ 600 Ω (20 mA)

In accordance with NE 43 or freely configurable

Relay output
 1 PDT
 AgSnO₂, hard gold-plated
 30 V AC (30 V DC)
 0.5 A (30 V AC) / 1 A (30 V DC)

24 V ... 230 V AC/DC (-20%/+10%, 50/60 Hz)
 <1.5 W
 0.01%/K
 <0.1% (e.g., for Pt 100, 300 K span, 4 ... 20 mA)

Ordering data

Type	Order No.	Pcs./Pkt.
MACX MCR-T-UI-UP	2811394	1
MACX MCR-T-UI-UP-SP	2811860	1
MACX MCR-T-UI-UP-C	2811873	1
MACX MCR-T-UI-UP-SP-C	2811970	1

Accessories

IFS-USB-PROG-ADAPTER	2811271	1
MACX MCR-CJC	2924993	1

Programming adapter for configuring modules with S-PORT interface	
Cold junction compensation connector for thermocouples	

MACX Analog – Signal conditioners with functional safety

Order key for MACX MCR-T-UI-UP(-SP)-C temperature transducers (standard configuration entered as an example)

Order No.	Safety Integrity Level (SIL)	Sensor type	Connection technology	Cold junction compensation	Measuring range:		Measuring unit	Output range	Factory calibration certificate = FCC
					Start	End			
2811873	ON	PT100	4	0	-50	150	C	OUT02	NONE
2811873 ≙ MACX MCR-T-UI-UP-C	ON ≙ Active NONE ≙ Not active	See below	2 ≙ 2-conductor 3 ≙ 3-conductor 4 ≙ 4-conductor	0 ≙ Off, e.g., with RTD, R, potentiometer, mV 1 ≙ On, e.g., with TC	See below	See below	C ≙ °C F ≙ °F O ≙ Ω P ≙ % V ≙ mV	OUT15 ≙ 0 ... 5 mA OUT16 ≙ 0 ... 10 mA OUT01 ≙ 0 ... 20 mA OUT15 ≙ 0 ... 5 mA OUT25 ≙ 1 ... 5 mA OUT26 ≙ 2 ... 10 mA OUT02 ≙ 4 ... 20 mA OUT05 ≙ 0 ... 5 V OUT03 ≙ 0 ... 10 V OUT06 ≙ 1 ... 5 V OUT04 ≙ 2 ... 10 V OUT13 ≙ -5 ... +5 V OUT14 ≙ -10 ... +10 V Others can be freely configured in the software	NONE ≙ Without FCC YES ≙ With FCC (a fee is charged) YESPLUS ≙ FCC with 5 measuring points (a fee is charged)
2811970 ≙ MACX MCR-T-UI-UP-SP-C	ON only with output range = OUT02								
Resistance temperature detector (RTD)								Smallest measuring range span	Other setting options can be configured with the IFS-CONF software:
PT50 ≙ Pt 50 IEC60751					-200	850	°C	20k	- Freely configurable user characteristic curve with 30 support points - Output behavior in the event of a short circuit, sensor break or overrange/underrange can be freely configured or set in accordance with NE43 (standard configuration: NE43 upscale) - Filter setting (standard configuration: 1) - Restart after failsafe (standard configuration: ON) - Switching behavior: switching output (limit values, times, etc.) (standard configuration: OFF)
PT100 ≙ Pt 100 IEC60751					-200	850	°C	20k	
PT200 ≙ Pt 200 IEC60751					-200	850	°C	20k	
PT500 ≙ Pt 500 IEC60751					-200	850	°C	20k	
PT1000 ≙ Pt 1000 IEC60751					-200	850	°C	20k	
PT2000 ≙ Pt 2000 IEC60751					-200	850	°C	20k	
PT5000 ≙ Pt 5000 IEC60751					-200	850	°C	20k	
PT50S ≙ PT50 SAMA RC21-4-1966					-200	850	°C	20k	
PT100S ≙ PT100 SAMA RC21-4-1966					-200	850	°C	20k	
PT200S ≙ PT200 SAMA RC21-4-1966					-200	850	°C	20k	
PT500S ≙ PT500 SAMA RC21-4-1966					-200	850	°C	20k	
PT1000S ≙ PT1000 SAMA RC21-4-1966					-200	850	°C	20k	
PT2000S ≙ PT2000 SAMA RC21-4-1966					-200	850	°C	20k	
PT5000S ≙ PT5000 SAMA RC21-4-1966					-200	850	°C	20k	
PT100G ≙ PT100 G GOST 6651-2009 (α=0.00391)					-200	850	°C	20k	
PT200G ≙ PT200 G GOST 6651-2009 (α=0.00391)					-200	850	°C	20k	
PT500G ≙ PT500 G GOST 6651-2009 (α=0.00391)					-200	850	°C	20k	
PT1000G ≙ PT1000 G GOST 6651-2009 (α=0.00391)					-200	850	°C	20k	
PT100J ≙ Pt 100 JIS C1604/1997					-200	850	°C	20k	
PT200J ≙ Pt 200 JIS C1604/1997					-200	850	°C	20k	
PT500J ≙ Pt 500 JIS C1604/1997					-200	850	°C	20k	
PT1000J ≙ Pt 1000 JIS C1604/1997					-200	850	°C	20k	
NI100 ≙ Ni100 DIN 43760					-60	250	°C	20k	
NI200 ≙ Ni200 DIN 43760					-60	250	°C	20k	
NI500 ≙ Ni500 DIN 43760					-60	250	°C	20k	
NI1000 ≙ Ni1000 DIN 43760					-60	250	°C	20k	
NI100S ≙ Ni100 SAMA RC21-4-1966					-60	180	°C	20k	
NI200S ≙ Ni200 SAMA RC21-4-1966					-60	180	°C	20k	
NI500S ≙ Ni500 SAMA RC21-4-1966					-60	180	°C	20k	
NI1000S ≙ Ni1000 SAMA RC21-4-1966					-60	180	°C	20k	
NI1000L ≙ Ni1000 Landis&Gyr					-50	160	°C	20k	
CU10 ≙ CU10 SAMA RC21-4-1966					-70	500	°C	20k	
CU50 ≙ CU 50 GOST 6651-2009 (α=0.00428)					-50	200	°C	20k	
CU100 ≙ CU 100 GOST 6651-2009 (α=0.00428)					-50	200	°C	20k	
CU53 ≙ CU 53 GOST 6651-2009 (α=0.00426)					-50	180	°C	20k	
KTY81 ≙ KTY81 KTY81-110 (Philips)					-55	150	°C	20k	
KTY84 ≙ KTY81 KTY84-130 (Philips)					-40	300	°C	20k	
Thermocouples (TC)									
A1G ≙ A-1 GOST 8.585-2001					0	2,500	°C	50k	
A2G ≙ A-2 GOST 8.585-2001					0	1,800	°C	50k	
A3G ≙ A-3 GOST 8.585-2001					0	1,800	°C	50k	
B ≙ B IEC584-1 (Pt30Rh-Pt6Rh)					500	1,820	°C	50k	
C ≙ C ASTM E988					0	2,315	°C	50k	
D ≙ DA ASTM E988(2002)					0	2,315	°C	50k	
E ≙ E IEC584-1 (NiCr-CuNi)					-230	1,000	°C	50k	
J ≙ J IEC584-1 (Fe-CuNi)					-210	1,200	°C	50k	
K ≙ K IEC584-1 (NiCr-Ni)					-250	1,372	°C	50k	
MG ≙ MG GOST 8.585-2001					-200	100	°C	50k	
N ≙ N IEC 584-1 (NiCrSi-NiSi)					-200	1,300	°C	50k	
R ≙ R IEC 584-1 (Pt13Rh-Pt)					-50	1,768	°C	50k	
S ≙ S IEC 584-1 (Pt10Rh-Pt)					-50	1,768	°C	50k	
T ≙ T IEC 584-1 (Cu-CuNi)					-200	400	°C	50k	
L ≙ L DIN 43760 (Fe-CuNi)					-200	900	°C	50k	
LG ≙ LG GOST 8.585-2001					-200	800	°C	50k	
U ≙ U DIN 43760 (Cu-CuNi)					-200	600	°C	50k	
Remote resistance-type sensors (R) (2-, 3-, 4-conductor)									
RES12 ≙ Resistance 0...50,000 Ω For more values, visit www.phoenixcontact.com					0	50,000	Ω	10% of the selected measuring range	
Potentiometers (3-conductor)									
POT12 ≙ Potentiometer 0...50,000 Ω For more values, visit www.phoenixcontact.com					0	50,000	Ω	10% of the selected measuring range	
Voltage signals (mV)									
V04 ≙ Voltage -1,000 mV...+1,000 mV For more values, visit www.phoenixcontact.com					-1,000	1,000	mV	10% of nominal span	

Temperature conversion guide for °C to °F:

$$T [^{\circ}F] = \frac{9}{5} T [^{\circ}C] + 32$$

Temperature, temperature transducers

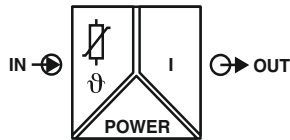

Programmable temperature transducers for operating resistance thermometers and resistance-type sensors. The measured values are converted into a linear 0 to 20 mA or 4 to 20 mA signal.

- Input for resistance thermometers, potentiometers, and resistance-type sensors
- 0 to 20 mA or 4 to 20 mA output
- Configuration via software (FDT/DTM): Sensor type, connection method, measuring range, measuring unit, filter, alarm signal, and output range
- Programming during operation and also voltage-free using IFS-USB-PROG-ADAPTER programming adapter
- Status indicator for supply voltage, cable, sensor, and module errors
- 3-way electrical isolation
- Power supply via DIN rail connector possible
- Installation in zone 2 permitted
- Up to SIL 2 in accordance with IEC 61508

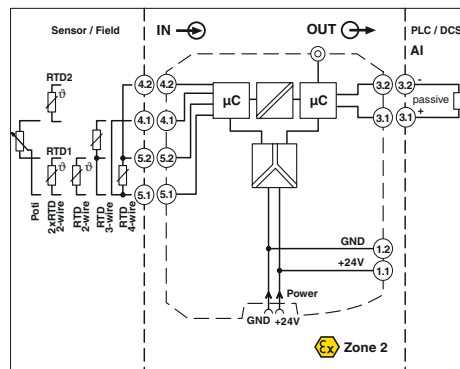

new

Temperature transducer for resistance thermometers and resistance-type sensors

Housing width 12.5 mm

Technical data

Input data	Resistance thermometers Resistor Potentiometer Cable resistance Sensor input current	Pt, Ni, Cu sensors: 2-, 3-, 4-conductor 0 Ω ... 50 kΩ 0 Ω ... 50 kΩ ≤50 Ω per cable 10 µA ... 210 µA (up to 2 x 210 µA for 3-conductor)
Measuring range span		≥50 K
Output data	Output signal Load Behavior in the event of a sensor error Output ripple	0 mA ... 20 mA / 4 mA ... 20 mA (SIL) ≤600 Ω As per NE 43 or can be freely defined <15 µA _{pp}
General data	Supply voltage range Current draw Power dissipation Temperature coefficient Step response (0 - 99%)	19.2 V DC ... 30 V DC (24 V DC -20%...+25%) ≤40 mA (24 V DC) ≤0.74 W 0.01%/K Typically 1 s ≤1.7 s
Transmission error, total ZERO / SPAN adjustment Electrical isolation	Input/output/power supply	300 V _{rms} (rated insulation voltage (overvoltage category II; degree of pollution 2, safe isolation as per EN 61010-1)) 2.5 kV (50 Hz, 1 min., test voltage)
Ambient temperature range Humidity Status indication	Input/output Input/power supply	375 V (peak value in accordance with EN 60079-11) 375 V (peak value in accordance with EN 60079-11) -40°C ... 70°C (any mounting position) 5% ... 95% (non-condensing) Green LED (supply voltage, PWR) Red LED, flashing 2.4 Hz (cable error, sensor error on input or output, ERR) Red LED, flashing 1.2 Hz (service operation, ERR) Red LED, permanently on (module error, ERR)
Inflammability class in accordance with UL 94 Housing material Dimensions W/H/D Screw connection rigid / flexible / AWG Push-in connection rigid / flexible / AWG		V0 PA 6.6-FR 12.5 / 112.5 / 114.5 mm 0.2 ... 2.5 mm ² / 0.2 ... 2.5 mm ² / 24 - 14 0.2 ... 1.5 mm ² / 0.2 ... 1.5 mm ² / 24 - 16
Conformance/approvals		CE-compliant, additionally EN 61326 Ex II 3(1) G Ex ec ic [ia Ga] IIC T4 Gc X Ex ec ic [ia Ga] IIC T4 Gc 2
Description		

Ordering data

Type	Order No.	Pcs./Pkt.
MACX MCR-RTD-I	1050192	1
MACX MCR-RTD-I-SP	1050201	1
MACX MCR-RTD-I-C	1052472	1
MACX MCR-RTD-I-SP-C	1052464	1

Accessories

IFS-USB-PROG-ADAPTER	2811271	1
----------------------	---------	---

Programming adapter for configuring modules with S-PORT interface

MACX Analog – Signal conditioners with functional safety

Order key for MACX MCR-RTD-I-(SP)-C temperature transducers (standard configuration entered as an example)

Order No.	SIL ON/OFF	Sensor type	Measuring unit	Connection technology	Measuring range:		Output signal	Sliding mean value	Alarm signal, short circuit	Alarm signal, sensor break	Factory calibration certificate
					Start	End					
1052472	ON	PT100	C	4	-50	150	OUT02	1	I000	I000	NONE
1052472 ≙ MACX MCR-RTD-I-C	ON ≙ Active NONE ≙ Not active	See below	Celsius [C] Ω [O] Millivolts [V]	2 ≙ 2-conductor 3 ≙ 3-conductor 4 ≙ 4-conductor	See below	See below	0...20 mA [OUT01] 4...20 mA [OUT02] 0...5 mA [OUT15] 0...10 mA [OUT16] 1...5 mA [OUT25] 2...10 mA [OUT26]	1 - 10	0 mA [I000] 3.5 mA [I035] 21.5 mA [I215]	0 mA [I000] 3.5 mA [I035] 21.5 mA [I215]	NONE ≙ Without FCC YES ≙ With FCC (a fee is charged) YESPLUS ≙ FCC with 5 measuring points (a fee is charged)
1052464 ≙ MACX MCR-RTD-I-SP-C	ON only with output range = OUT02										

Resistance temperature detector (RTD)

PT50	≙ Pt 50 IEC60751	°C	-200	850	20k
PT100	≙ Pt 100 IEC60751	°C	-200	850	20k
PT200	≙ Pt 200 IEC60751	°C	-200	850	20k
PT500	≙ Pt 500 IEC60751	°C	-200	850	20k
PT1000	≙ Pt 1000 IEC60751	°C	-200	850	20k
PT2000	≙ Pt 2000 IEC60751	°C	-200	850	20k
PT5000	≙ Pt 5000 IEC60751	°C	-200	850	20k
PT50S	≙ PT50 SAMA RC21-4-1966	°C	-200	850	20k
PT100S	≙ PT100 SAMA RC21-4-1966	°C	-200	850	20k
PT200S	≙ PT200 SAMA RC21-4-1966	°C	-200	850	20k
PT500S	≙ PT500 SAMA RC21-4-1966	°C	-200	850	20k
PT1000S	≙ PT1000 SAMA RC21-4-1966	°C	-200	850	20k
PT2000S	≙ PT2000 SAMA RC21-4-1966	°C	-200	850	20k
PT5000S	≙ PT5000 SAMA RC21-4-1966	°C	-200	850	20k
PT100G	≙ PT100 G GOST 6651-2009 (α=0.00391)	°C	-200	850	20k
PT200G	≙ PT200 G GOST 6651-2009 (α=0.00391)	°C	-200	850	20k
PT500G	≙ PT500 G GOST 6651-2009 (α=0.00391)	°C	-200	850	20k
PT1000G	≙ PT1000 G GOST 6651-2009 (α=0.00391)	°C	-200	850	20k
PT100J	≙ Pt 100 JIS C1604/1997	°C	-200	850	20k
PT200J	≙ Pt 200 JIS C1604/1997	°C	-200	850	20k
PT500J	≙ Pt 500 JIS C1604/1997	°C	-200	850	20k
PT1000J	≙ Pt 1000 JIS C1604/1997	°C	-200	850	20k
NI100	≙ Ni100 DIN 43760	°C	-60	250	20k
NI200	≙ Ni200 DIN 43760	°C	-60	250	20k
NI500	≙ Ni500 DIN 43760	°C	-60	250	20k
NI1000	≙ Ni1000 DIN 43760	°C	-60	250	20k
NI100S	≙ Ni100 SAMA RC21-4-1966	°C	-60	180	20k
NI200S	≙ Ni200 SAMA RC21-4-1966	°C	-60	180	20k
NI500S	≙ Ni500 SAMA RC21-4-1966	°C	-60	180	20k
NI1000S	≙ Ni1000 SAMA RC21-4-1966	°C	-60	180	20k
NI1000L	≙ Ni1000 Landis&Gyr	°C	-50	160	20k
CU10	≙ CU10 SAMA RC21-4-1966	°C	-70	500	100k
CU50	≙ CU 50 GOST 6651-2009 (α=0.00428)	°C	-50	200	100k
CU100	≙ CU 100 GOST 6651-2009 (α=0.00428)	°C	-50	200	100k
CU53	≙ CU 53 GOST 6651-2009 (α=0.00426)	°C	-50	180	100k
KTY81	≙ KTY81 KTY81-110 (Philips)	°C	-55	150	20k
KTY84	≙ KTY81 KTY84-130 (Philips)	°C	-40	300	20k
RES02	≙ Resistance 0...75 Ω	Ω	0	75	10% of the selected measuring range
RES03	≙ Resistance 0...150 Ω	Ω	0	150	
RES04	≙ Resistance 0...300 Ω	Ω	0	300	
RES05	≙ Resistance 0...600 Ω	Ω	0	600	
RES06	≙ Resistance 0...1,200 Ω	Ω	0	1200	
RES07	≙ Resistance 0...2,400 Ω	Ω	0	2400	
RES08	≙ Resistance 0...4,800 Ω	Ω	0	4800	
RES09	≙ Resistance 0...6,250 Ω	Ω	0	6250	
RES10	≙ Resistance 0...12,500 Ω	Ω	0	12500	
RES11	≙ Resistance 0...25,000 Ω	Ω	0	25000	
RES12	≙ Resistance 0...50,000 Ω	Ω	0	50,000	

Other setting options can be configured with the IFS-CONF software:

- Freely configurable user characteristic curve with 30 support points
- Output behavior in the event of a short circuit, sensor break or over-range/under-range can be freely configured or set in accordance with NE43 (standard configuration: NE43 upscale)
- Filter setting (standard configuration: 1)
- Restart after failsafe (standard configuration: ON)
- Switching behavior: switching output (limit values, times, etc.) (standard configuration: OFF)

Remote resistance-type sensors (R) (2-, 3-, 4-conductor)

Temperature conversion guide for °C to °F:

$$T [°F] = \frac{9}{5} T [°C] + 32$$

Temperature, temperature transducers

new

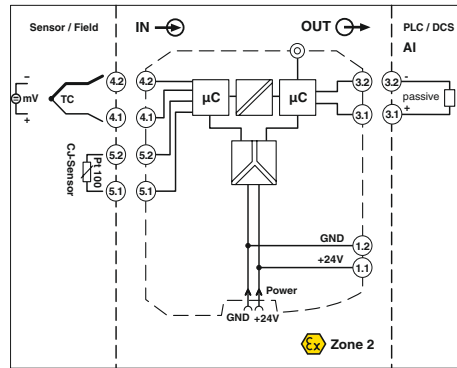
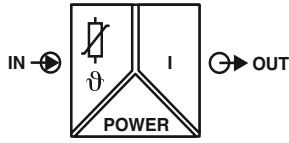

Temperature transducer for thermocouples

Housing width 12.5 mm

- Programmable temperature transducers for operating thermocouples and mV sources. The measured values are converted into a linear 0 to 20 mA or 4 to 20 mA signal.
- Input for thermocouples and mV signals
- 0 to 20 mA or 4 to 20 mA output
- Configuration via software (FDT/DTM): Sensor type, connection method, measuring range, measuring unit, filter, alarm signal, and output range
- Programming during operation and also voltage-free using IFS-USB-PROG-ADAPTER programming adapter
- Status indicator for supply voltage, cable, sensor, and module errors
- 3-way electrical isolation
- Power supply via DIN rail connector possible
- Installation in zone 2 permitted
- Up to SIL 2 in accordance with IEC 61508

Input data

Thermocouple sensors

Voltage
Measuring range span

Output data

Output signal
Load
Behavior in the event of a sensor error
Output ripple

General data

Supply voltage range
Current consumption
Power consumption
Power dissipation
Temperature coefficient
Step response (0 - 99%)

Transmission error, total
Cold junction errors
ZERO / SPAN adjustment
Electrical isolation

Input/output/power supply

Input/output
Input/power supply

Ambient temperature range
Humidity
Inflammability class in accordance with UL 94
Housing material
Dimensions W/H/D
Screw connection rigid / flexible / AWG
Conformance/approvals
SIL in accordance with IEC 61508

Technical data

B, E, J, K, N, R, S, T, L, U, C, D, A-1, A-2, A-3, M, Lr

-1,000 mV ... 1,000 mV
Min. 50 K with thermocouple, 10% of the nominal span of the respective range with mV sources

0 mA ... 20 mA / 4 mA ... 20 mA (SIL)
≤600 Ω
As per NE 43 or can be freely defined
<15 µA_{pp}

19.2 V DC ... 30 V DC (24 V DC -20%...+25%)
<40 mA (24 V DC)
≤1 W
≤0.74 W
0.01%/K
Typically 700 ms
≤1,000 ms
0.1% x 600 [K]/measuring span; 0.1% >600 [K]
± 1 K
± 5% / ± 5%

300 V_{rms} (rated insulation voltage (overvoltage category II; degree of pollution 2, safe isolation as per EN 61010-1))
2.5 kV (50 Hz, 1 min., test voltage)

375 V (peak value in accordance with EN 60079-11)
375 V (peak value in accordance with EN 60079-11)
-40°C ... 70°C (any mounting position)
5% ... 95% (non-condensing)
V0
PA 6.6-FR
12.5 / 112.5 / 114.5 mm
0.2 ... 2.5 mm² / 0.2 ... 2.5 mm² / 24 - 14

2

Ordering data

Type	Order No.	Pcs./Pkt.
MACX MCR-TC-I	1050228	1
MACX MCR-TC-I-C	1052459	1

Accessories

IFS-USB-PROG-ADAPTER	2811271	1
IOA MCR-CJC-PT100	1085776	1

Description

Programming adapter for configuring modules with S-PORT interface
Cold junction compensation connector for thermocouples

MACX Analog – Signal conditioners with functional safety

Order key for MACX MCR-TC-I-C temperature transducers (standard configuration entered as an example)

Order No.	SIL	Sensor type	Measuring unit	Cold junction compensation	Measuring range:		Output signal	Sliding mean value	Alarm signal, short circuit	Alarm signal, sensor break	Factory calibration certificate	
					Start	End					NONE	YES
1052459	ON	K	C	ON	-50	150	OUT02	1	I000	I000	NONE	
1052459 ≙ MACX MCR-TC-I-C	ON ≙ Active NONE ≙ Not active ON only with output range = OUT02	See below	Celsius [C] Ω [O] Millivolts [V]	ON OFF	See below	See below	0...20 mA [OUT01] 4...20 mA [OUT02] 0...5 mA [OUT15] 0...10 mA [OUT16] 1...5 mA [OUT25] 2...10 mA [OUT26]	1 - 10	0 mA [I000] 3.5 mA [I035] 21.5 mA [I215]	0 mA [I000] 3.5 mA [I035] 21.5 mA [I215]	NONE ≙ Without FCC YES ≙ With FCC (a fee is charged) YESPLUS ≙ FCC with 5 measuring points (a fee is charged)	

Thermocouples (TC)

A1G	≙ A-1 GOST 8.585-2001	°C	0	2,500	50k
A2G	≙ A-2 GOST 8.585-2001	°C	0	1,800	50k
A3G	≙ A-3 GOST 8.585-2001	°C	0	1,800	50k
B	≙ B IEC584-1 (Pt30Rh-Pt6Rh)	°C	500	1,820	50k
C	≙ C ASTM E988	°C	0	2,315	50k
D	≙ DA ASTM E988(2002)	°C	0	2,315	50k
E	≙ E IEC584-1 (NiCr-CuNi)	°C	-230	1,000	50k
J	≙ J IEC584-1 (Fe-CuNi)	°C	-210	1,200	50k
K	≙ K IEC584-1 (NiCr-Ni)	°C	-250	1,372	50k
MG	≙ MG GOST 8.585-2001	°C	-200	100	50k
N	≙ N IEC 584-1 (NiCrSi-NiSi)	°C	-200	1,300	50k
R	≙ R IEC 584-1 (Pt13Rh-Pt)	°C	-50	1,768	50k
S	≙ S IEC 584-1 (Pt10Rh-Pt)	°C	-50	1,768	50k
T	≙ T IEC 584-1 (Cu-CuNi)	°C	-200	400	50k
L	≙ L DIN 43760 (Fe-CuNi)	°C	-200	900	50k
LG	≙ LG GOST 8.585-2001	°C	-200	800	50k
U	≙ U DIN 43760 (Cu-CuNi)	°C	-200	600	50k
V04	≙ Voltage -1,000 mV...+1,000 mV	mV	-1,000	1,000	10% of nominal span
V05	≙ Voltage -500 mV...+500 mV	mV	-500	500	
V06	≙ Voltage -250 mV...+250 mV	mV	-250	250	
V07	≙ Voltage -125 mV...+125 mV	mV	-125	125	
V08	≙ Voltage -60 mV...+60 mV	mV	-60	60	
V09	≙ Voltage -30 mV...+30 mV	mV	-30	30	
V10	≙ Voltage -15 mV...+15 mV	mV	-15	150	

Smallest measuring range span

Other setting options can be configured with the IFS-CONF software:

- Freely configurable user characteristic curve with 30 support points
- Output behavior in the event of a short circuit, sensor break or over-range/under-range can be freely configured or set in accordance with NE43 (standard configuration: NE43 upscale)
- Filter setting (standard configuration: 1)
- Restart after failsafe (standard configuration: ON)
- Switching behavior: switching output (limit values, times, etc.) (standard configuration: OFF)

Temperature conversion guide for °C to °F:

$$T [°F] = \frac{9}{5} T [°C] + 32$$

Digital IN
NAMUR signal conditioners

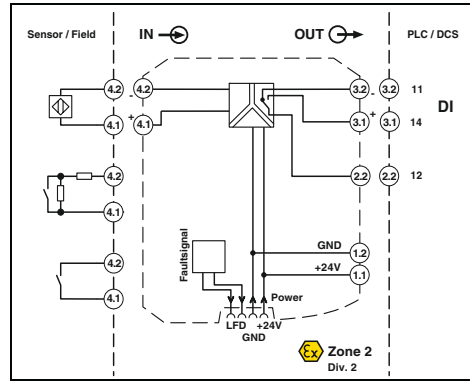
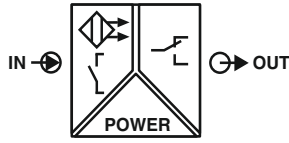

NAMUR signal conditioner,
signal output: PDT relay

ERIE DNV GL Functional Safety
Ex:
Housing width 12.5 mm

NAMUR signal conditioners for operating proximity sensors and mechanical contacts

- Input for NAMUR proximity sensors (EN 60947-5-6), floating contacts or contacts with resistance circuit
- Relay signal output (PDT)
- Reversible direction of action (operating current or closed-circuit current behavior)
- Line fault detection (LFD) can be activated and deactivated, error indicated by red flashing led and de-excitation of the output relay
- Power supply and error indication possible via the DIN rail connector
- LED displays for indicating supply voltage, circuit state, and malfunctions to NAMUR NE 44
- 3-way electrical isolation
- Up to SIL 2 in accordance with IEC 61508
- Installation in zone 2 permitted

Notes:
Information about the supply and error evaluation module as well as about the DIN rail connectors and marking material can be found from page 175
Information about resistance circuits is given on page 177
Information on "Plug and play" connection using system cabling can be found from page 170

Input data
Input signal

No-load voltage
Switching points
Switching hysteresis
Line error detection

Switching output

Contact type
Contact material
Max. switching voltage
Maximum switching capacity
Recommended minimum load
Mechanical service life
Switching behavior
Maximum switching frequency

General data

Supply voltage range
Current consumption
Power dissipation
Electrical isolation

Input/output
Input/output/supply, DIN rail connector

Output/input, supply, TBUS

Input/supply, DIN rail connector

Ambient temperature range
Humidity
Inflammability class in accordance with UL 94
Housing material
Dimensions W/H/D
Screw connection rigid / flexible / AWG
Push-in connection rigid / flexible / AWG
Conformance/approvals
Conformance
ATEX
UL, USA/Canada

SIL in accordance with IEC 61508

Technical data

NAMUR proximity sensors (EN 60947-5-6)
open circuit switch contacts
Switch contacts with resistance circuit
~ 8 V DC
>2.1 mA (conductive) / <1.2 mA (blocking)
<0.2 mA
Break 0.05 mA <IIN <0.35 mA
Short circuit 100 Ω <RSensor <360 Ω

Relay output

1 PDT
AgSnO₂, hard gold-plated
250 V AC (2 A) / 120 V DC (0.2 A) / 30 V DC (2 A)
500 VA
5 V / 10 mA
10⁷ cycles
Can be inverted via slide switch
≤20 Hz (without load)

19.2 V DC ... 30 V DC (24 V DC -20%...+25%)
21 mA (24 V DC)
<650 mW

375 V (peak value in accordance with EN 60079-11)
300 V_{rms} (rated insulation voltage (overvoltage category II);
degree of pollution 2, safe isolation as per EN 61010-1)
2.5 kV (50 Hz, 1 min., test voltage)

300 V_{rms} (rated insulation voltage (overvoltage category III);
degree of pollution 2, safe isolation as per EN 61010-1)
2.5 kV (50 Hz, 1 min., test voltage)

375 V (peak value in accordance with EN 60079-11)
-20°C ... 60°C (any mounting position)
10% ... 95% (non-condensing)
V0
PA 6.6-FR
12.5 / 112.5 / 114.5 mm
0.2 ... 2.5 mm² / 0.2 ... 2.5 mm² / 24 - 14
0.2 ... 1.5 mm² / 0.2 ... 1.5 mm² / 24 - 16

CE-compliant, additionally EN 61326-1
 II 3 G Ex nA nC IIC T4 Gc X
UL 508 Listed
UL 61010 Listed
Class I, Div. 2, Groups A, B, C, D T4
Class I, Zone 2, Group IIC T4
2

Ordering data

Description	Type	Order No.	Pcs./Pkt.	
NAMUR signal conditioners	Screw connection	MACX MCR-SL-NAM-R	2865997	1
	Push-in connection	MACX MCR-SL-NAM-R-SP	2924252	1

Digital IN
NAMUR signal conditioners

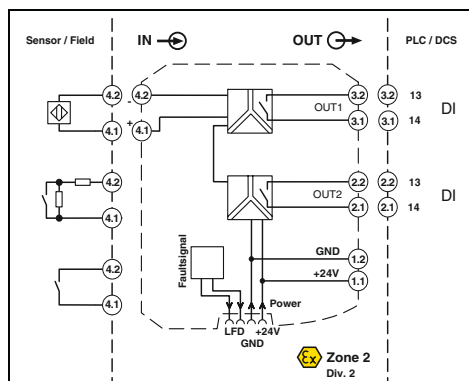
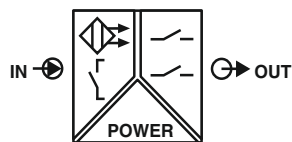

NAMUR signal conditioner,
2 signal outputs: N/O relay

DNV GL Functional Safety

Ex: Ex n

Housing width 12.5 mm

NAMUR signal conditioners for operating proximity sensors and mechanical contacts

- Input for NAMUR proximity sensors (EN 60947-5-6), floating contacts or contacts with resistance circuit
- 2 relay signal outputs (N/O contact), output 2 can also be used as an error signal output
- Reversible direction of action (operating current or closed-circuit current behavior)
- Line fault detection (LFD) can be activated and deactivated, error indicated by red flashing led and de-excitation of the output relay
- Power supply and error indication possible via the DIN rail connector
- LED displays for indicating supply voltage, circuit state, and malfunctions to NAMUR NE 44
- 4-way electrical isolation
- Up to SIL 2 in accordance with IEC 61508
- Installation in zone 2 permitted

Notes:
Information about the supply and error evaluation module as well as about the DIN rail connectors and marking material can be found from page 175
Information about resistance circuits is given on page 177
Information on "Plug and play" connection using system cabling can be found from page 170

Input data	Input signal
No-load voltage	
Switching points	
Switching hysteresis	
Line error detection	
Switching output	
Contact type	
Contact material	
Max. switching voltage	
Maximum switching capacity	
Recommended minimum load	
Mechanical service life	
Switching behavior	
Maximum switching frequency	
General data	
Supply voltage range	
Current consumption	
Power dissipation	
Electrical isolation	Input/supply, DIN rail connector
	Output 1/output 2/input/power supply, DIN rail connector
Ambient temperature range	
Humidity	
Inflammability class in accordance with UL 94	
Housing material	
Dimensions W/H/D	
Screw connection rigid / flexible / AWG	
Push-in connection rigid / flexible / AWG	
Conformance/approvals	
Conformance	
ATEX	
UL, USA/Canada	
SIL in accordance with IEC 61508	

Technical data

NAMUR proximity sensors (EN 60947-5-6)
open circuit switch contacts
Switch contacts with resistance circuit
~ 8 V DC
>2.1 mA (conductive) / <1.2 mA (blocking)
<0.2 mA
Break 0.05 mA <I_{IN} <0.35 mA
Short circuit 100 Ω <R_{Sensor} <360 Ω
Relay output
2 N/O contacts
AgSnO₂, hard gold-plated
250 V AC (2 A) / 120 V DC (0.2 A) / 30 V DC (2 A)
500 VA
5 V / 10 mA
10⁷ cycles
Can be inverted via slide switch
≤20 Hz (without load)

Supply voltage range

19.2 V DC ... 30 V DC (24 V DC -20%...+25%)
30 mA (24 V DC)
<950 mW

300 V_{rms} (rated insulation voltage (overvoltage category II; degree of pollution 2, safe isolation as per EN 61010-1))

2.5 kV (50 Hz, 1 min., test voltage)

-20°C ... 60°C (any mounting position)
10% ... 95% (non-condensing)
V0
PA 6.6-FR
12.5 / 112.5 / 114.5 mm
0.2 ... 2.5 mm² / 0.2 ... 2.5 mm² / 24 - 14
0.2 ... 1.5 mm² / 0.2 ... 1.5 mm² / 24 - 16

CE-compliant, additionally EN 61326-1
Ex II 3 G Ex nA nC IIC T4 Gc X
UL 508 Listed
UL 61010 Listed
Class I, Div. 2, Groups A, B, C, D T4
Class I, Zone 2, Group IIC T4
2

Ordering data

Description	Type	Order No.	Pcs./Pkt.	
NAMUR signal conditioners	Screw connection	MACX MCR-SL-NAM-2RO	2865010	1
	Push-in connection	MACX MCR-SL-NAM-2RO-SP	2924265	1

Digital IN
NAMUR signal conditioners

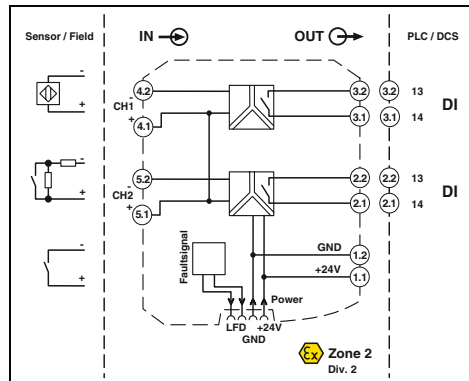
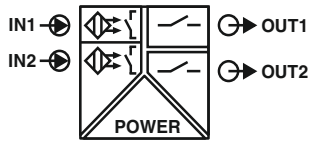

NAMUR signal conditioner, 2-channel,
output: 1 N/O contact per channel

DNV GL Functional Safety

Ex: Ex

Housing width 12.5 mm

NAMUR signal conditioners for intrinsically safe operation of proximity sensors and mechanical contacts installed in Ex areas.

- 2-channel
- Input for NAMUR proximity sensors (EN 60947-5-6), floating contacts or contacts with resistance circuit
- Relay signal output (N/O contact)
- Reversible direction of action (operating current or closed-circuit current behavior)
- Line fault detection (LFD) can be activated and deactivated, error indicated by red flashing led and de-excitation of the output relay
- Power supply and error indication possible via the DIN rail connector
- LED displays for indicating supply voltage, circuit state, and malfunctions to NAMUR NE 44
- 3-way electrical isolation
- Up to SIL 2 in accordance with IEC 61508
- Installation in zone 2 permitted

Notes:
Information about the supply and error evaluation module as well as about the DIN rail connectors and marking material can be found from page 175
Information about resistance circuits is given on page 177
Information on "Plug and play" connection using system cabling can be found from page 170

Input data
Input signal

No-load voltage
Switching points
Switching hysteresis
Line error detection

Switching output

Contact type
Contact material
Max. switching voltage
Maximum switching capacity
Recommended minimum load
Mechanical service life
Switching behavior
Maximum switching frequency

General data

Supply voltage range
Current consumption
Power dissipation
Electrical isolation

Input/supply, DIN rail connector

Output 1/output 2/input, power supply, DIN rail connector

Ambient temperature range
Humidity
Inflammability class in accordance with UL 94
Housing material
Dimensions W/H/D
Screw connection rigid / flexible / AWG
Push-in connection rigid / flexible / AWG

Conformance/approvals

Conformance
ATEX
UL, USA/Canada

SIL in accordance with IEC 61508

Technical data

NAMUR proximity sensors (EN 60947-5-6)
open circuit switch contacts
Switch contacts with resistance circuit
~ 8 V DC
>2.1 mA (conductive) / <1.2 mA (blocking)
<0.2 mA
Break 0.05 mA <IIN <0.35 mA
Short circuit 100 Ω <RSensor <360 Ω
Relay output
1 N/O contact per channel
AgSnO₂, hard gold-plated
250 V AC (2 A) / 120 V DC (0.2 A) / 30 V DC (2 A)
500 VA
5 V / 10 mA
10⁷ cycles
Can be inverted via slide switch
≤20 Hz (without load)

19.2 V DC ... 30 V DC (24 V DC -20%...+25%)
35 mA (24 V DC)
<1 W

300 V_{rms} (rated insulation voltage (overvoltage category II; degree of pollution 2, safe isolation as per EN 61010-1))

300 V_{rms} (rated insulation voltage (overvoltage category III; degree of pollution 2, safe isolation as per EN 61010-1))

-20°C ... 60°C (any mounting position)
5% ... 95% (non-condensing)
V0
PA 6.6-FR
12.5 / 112.5 / 114.5 mm
0.2 ... 2.5 mm² / 0.2 ... 2.5 mm² / 24 - 14
0.2 ... 1.5 mm² / 0.2 ... 1.5 mm² / 24 - 16

CE-compliant, additionally EN 61326-1
Ex II 3 G Ex nA nC IIC T4 Gc X
UL 508 Listed
UL 61010 Listed
Class I, Div. 2, Groups A, B, C, D T4
Class I, Zone 2, Group IIC T4
2

Ordering data

Description	Ordering data			
	Type	Order No.	Pcs./Pkt.	
NAMUR signal conditioner	Screw connection	MACX MCR-SL-2NAM-RO	2865049	1
	Push-in connection	MACX MCR-SL-2NAM-RO-SP	2924294	1

Digital IN
NAMUR signal conditioners

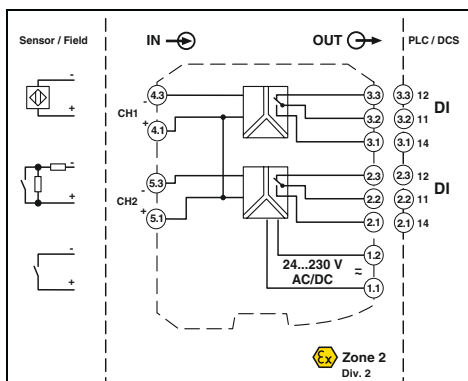
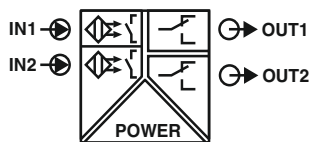

NAMUR signal conditioner, 2-channel,
output: 1 N/O contact per channel,
with wide range supply

Functional Safety

Ex: Ex n Ex

Housing width 17.5 mm

NAMUR signal conditioners for operating proximity sensors and mechanical contacts

- 2-channel
- Input for NAMUR proximity sensors (EN 60947-5-6), floating contacts or contacts with resistance circuit
- Relay signal output (PDT)
- Reversible direction of action (operating current or closed-circuit current behavior)
- Line fault detection (LFD) can be activated and deactivated, error indicated by red flashing led and de-excitation of the output relay
- Wide-range power supply of 19.2 to 253 V AC/DC
- LED displays for indicating supply voltage, circuit state, and malfunctions to NAMUR NE 44
- 3-way electrical isolation
- Up to SIL 2 in accordance with IEC 61508
- Installation in zone 2 permitted

Notes:
Information on resistance circuits and marking material can be found on page 177

Input data	Input signal
	No-load voltage Switching points Switching hysteresis Line error detection
Switching output	Contact type Contact material Max. switching voltage Maximum switching capacity Recommended minimum load Mechanical service life Switching behavior Maximum switching frequency
General data	Supply voltage range Current consumption Power dissipation Electrical isolation
	Ambient temperature range Humidity Inflammability class in accordance with UL 94 Housing material Dimensions W/H/D Screw connection rigid / flexible / AWG Push-in connection rigid / flexible / AWG
Conformance/approvals	Conformance ATEX UL, USA/Canada
	SIL in accordance with IEC 61508

Technical data

NAMUR proximity sensors (EN 60947-5-6) open circuit switch contacts Switch contacts with resistance circuit ~ 8 V DC >2.1 mA (conductive) / <1.2 mA (blocking) <0.2 mA Break 0.05 mA <I _{IN} <0.35 mA Short circuit 100 Ω <R _{Sensor} <360 Ω	Relay output 1 PDT per channel AgSnO ₂ , hard gold-plated 250 V AC (2 A, 60 Hz) / 120 V DC (0.2 A) / 30 V DC (2 A) 500 VA 5 V / 10 mA 10 ⁷ cycles Can be inverted using DIP switch ≤20 Hz (load-dependent)
19.2 V AC/DC ... 253 V AC/DC (24 V AC/DC ... 230 V AC/DC (-20% ... +10%, 50/60 Hz)) <80 mA ; <42 mA (24 V DC) ≤1.3 W	375 V (peak value in accordance with EN 60079-11) 375 V (peak value in accordance with EN 60079-11) 300 V _{rms} (rated insulation voltage (overvoltage category II; degree of pollution 2, safe isolation as per EN 61010-1)) 2.5 kV AC (50 Hz, 1 min., test voltage)
-20°C ... 60°C 10% ... 95% (non-condensing) V0 PA 6.6-FR 17.5 / 112.5 / 114.5 mm 0.2 ... 2.5 mm ² / 0.2 ... 2.5 mm ² / 24 - 14 0.2 ... 1.5 mm ² / 0.2 ... 1.5 mm ² / 24 - 16	CE-compliant, additionally EN 61326-1 Ex II 3 G Ex nA nC IIC T4 Gc X UL 508 Listed UL 61010 Listed Class I, Div. 2, Groups A, B, C, D T4 Class I, Zone 2, Group IIC T4 2

Ordering data

Description	Type	Order No.	Pcs./Pkt.	
NAMUR signal conditioner	Screw connection	MACX MCR-SL-2NAM-R-UP	2865052	1
	Push-in connection	MACX MCR-SL-2NAM-R-UP-SP	2924304	1

Digital IN
NAMUR signal conditioners

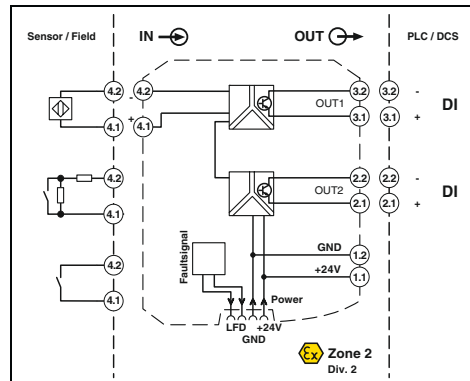
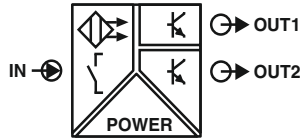

**NAMUR signal conditioner:
2 signal outputs: transistor (passive)**

DNV GL Functional Safety

Ex: Ex n

Housing width 12.5 mm

NAMUR signal conditioners for operating proximity sensors and mechanical contacts

- Input for NAMUR proximity sensors (EN 60947-5-6), floating contacts or contacts with resistance circuit
- 2 signal outputs transistor (passive), up to 5 kHz
- Signal output 2 can also be used as a fault signaling output
- Reversible direction of action (operating current or closed-circuit current behavior)
- Line fault detection (LFD) can be activated and deactivated, error indicated by red flashing LED and blocking the transistor output
- Power supply and error indication possible via the DIN rail connector
- LED displays for indicating supply voltage, circuit state, and malfunctions to NAMUR NE 44
- 4-way electrical isolation
- Up to SIL 2 in accordance with IEC 61508
- Installation in zone 2 permitted

Notes:
Information about the supply and error evaluation module as well as about the DIN rail connectors and marking material can be found from page 175
Information about resistance circuits is given on page 177
Information on "Plug and play" connection using system cabling can be found from page 170

Input data	
Input signal	
No-load voltage	
Switching points	
Line error detection	
Switching output	
Max. switching voltage	
Maximum switching current	
Drop (ΔU)	
Switching behavior	
Maximum switching frequency	
General data	
Supply voltage range	
Current consumption	
Power dissipation	
Electrical isolation	
Input/output/supply, DIN rail connector	
Output 1/output 2	
Ambient temperature range	
Humidity	
Inflammability class in accordance with UL 94	
Housing material	
Dimensions W/H/D	
Screw connection rigid / flexible / AWG	
Push-in connection rigid / flexible / AWG	
Conformance/approvals	
Conformance	
ATEX	
UL, USA/Canada	
SIL in accordance with IEC 61508	

Technical data

NAMUR proximity sensors (EN 60947-5-6)

open circuit switch contacts

Switch contacts with resistance circuit

~ 8 V DC

>2.1 mA (conductive) / <1.2 mA (blocking)

Break 0.05 mA <IIN <0.35 mA

Short circuit 100 Ω <RSensor <360 Ω

2 transistor outputs, passive

30 V DC

50 mA (short-circuit-proof)

<1.4 V

Can be inverted using DIP switch

\leq 5 kHz

19.2 V DC ... 30 V DC (24 V DC -20%...+25%)

<28 mA (24 V DC)

\leq 800 mW

300 V_{rms} (rated insulation voltage (overvoltage category II; degree of pollution 2, safe isolation as per EN 61010-1))
2.5 kV (50 Hz, 1 min., test voltage)

50 V_{rms} (rated insulation voltage (overvoltage category II; degree of pollution 2, basic insulation as per EN 61010-1))
1 kV (50 Hz, 1 min., test voltage)

-20°C ... 60°C (any mounting position)

10% ... 95% (non-condensing)

V0

PA 6.6-FR

12.5 / 112.5 / 114.5 mm

0.2 ... 2.5 mm² / 0.2 ... 2.5 mm² / 24 - 14

0.2 ... 1.5 mm² / 0.2 ... 1.5 mm² / 24 - 16

CE-compliant, additionally EN 61326-1

Ex II 3 G Ex nA IIC T4 Gc X

UL 508 Listed

UL 61010 Listed

Class I, Div. 2, Groups A, B, C, D T4

Class I, Zone 2, Group IIC T4

2

Ordering data

Description	Type	Order No.	Pcs./Pkt.
NAMUR signal conditioner	MACX MCR-SL-NAM-2T	2865023	1
Screw connection	MACX MCR-SL-NAM-2T-SP	2924278	1
Push-in connection			

Digital IN
NAMUR signal conditioners

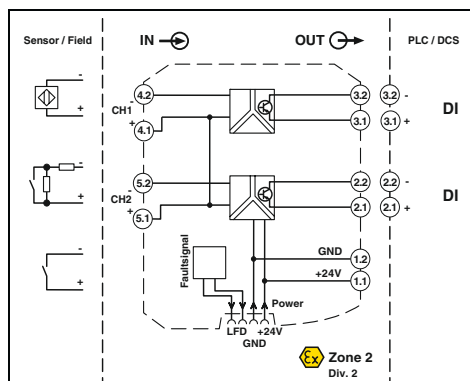
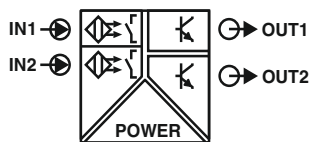

NAMUR signal conditioner, 2-channel,
signal output: transistor (passive)

DNV GL Functional Safety

Ex: Ex n Ex

Housing width 12.5 mm

NAMUR signal conditioners for operating proximity sensors and mechanical contacts

- 2-channel
- Input for NAMUR proximity sensors (EN 60947-5-6), floating contacts or contacts with resistance circuit
- Signal output transistor (passive), up to 5 kHz
- Reversible direction of action (operating current or closed-circuit current behavior)
- Line fault detection (LFD) can be activated and deactivated, error indicated by red flashing LED and blocking the transistor output
- Power supply and error indication possible via the DIN rail connector
- LED displays for indicating supply voltage, circuit state, and malfunctions to NAMUR NE 44
- 3-way electrical isolation
- Up to SIL 2 in accordance with IEC 61508
- Installation in zone 2 permitted

Notes:
Information about the supply and error evaluation module as well as about the DIN rail connectors and marking material can be found from page 175
Information about resistance circuits is given on page 177
Information on "Plug and play" connection using system cabling can be found from page 170

Input data		Technical data	
Input signal		NAMUR proximity sensors (EN 60947-5-6) open circuit switch contacts Switch contacts with resistance circuit ~ 8 V DC	
No-load voltage		>2.1 mA (conductive) / <1.2 mA (blocking)	
Switching points		Break 0.05 mA <IIN <0.35 mA	
Line error detection		Short circuit 100 Ω <RSensor <360 Ω	
Switching output		1 transistor output, passive (per channel)	
Max. switching voltage		30 V DC	
Maximum switching current		50 mA (short-circuit-proof)	
Drop (ΔU)		<1.4 V	
Switching behavior		Can be inverted using DIP switch	
Maximum switching frequency		≤5 kHz	
General data			
Supply voltage range		19.2 V DC ... 30 V DC (24 V DC -20%...+25%)	
Current consumption		<34 mA (24 V DC)	
Power dissipation		1,000 mW	
Electrical isolation			
Input/output/supply, DIN rail connector		300 V _{rms} (rated insulation voltage (overvoltage category II; degree of pollution 2, safe isolation as per EN 61010-1)) 2.5 kV (50 Hz, 1 min., test voltage)	
Output 1/output 2		50 V _{rms} (rated insulation voltage (overvoltage category II; degree of pollution 2, basic insulation as per EN 61010-1)) 1 kV (50 Hz, 1 min., test voltage)	
Ambient temperature range		-20°C ... 60°C (any mounting position)	
Humidity		10% ... 95% (non-condensing)	
Inflammability class in accordance with UL 94		V0	
Housing material		PA 6.6-FR	
Dimensions W/H/D		12.5 / 112.5 / 114.5 mm	
Screw connection rigid / flexible / AWG		0.2 ... 2.5 mm ² / 0.2 ... 2.5 mm ² / 24 - 14	
Push-in connection rigid / flexible / AWG		0.2 ... 1.5 mm ² / 0.2 ... 1.5 mm ² / 24 - 16	
Conformance/approvals			
Conformance		CE-compliant, additionally EN 61326	
ATEX		Ex II 3 G Ex nA IIC T4 Gc X	
UL, USA/Canada		UL 508 Listed UL 61010 Listed Class I, Div. 2, Groups A, B, C, D T4 Class I, Zone 2, Group IIC T4	
SIL in accordance with IEC 61508		2	

Description		Ordering data	
NAMUR signal conditioner		Type	Order No.
	Screw connection	MACX MCR-SL-2NAM-T	2865036
	Push-in connection	MACX MCR-SL-2NAM-T-SP	2924281
		Pcs./Pkt.	
			1
			1

Limit values, threshold value switches

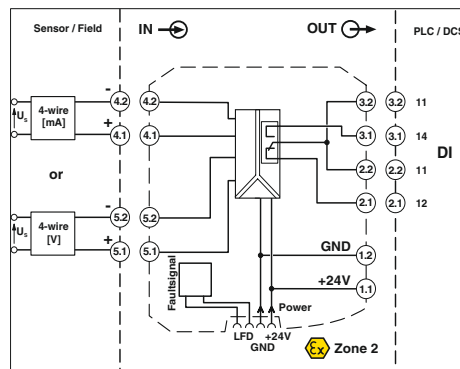
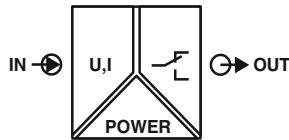

new

Configurable, with relay PDT output



Housing width 12.5 mm

- Input for analog standard current and voltage signals for switching analog limit values
- Safe 3-way isolation
- Configure limit values via DIP switch
- PDT relay at output
- Limiting continuous current up to 6 A
- Energy can be supplied via the DIN rail connector
- Status and error indicator LEDs
- Up to SIL 3 in accordance with IEC 61508
- PLC in accordance with ISO 13849
- Installation in zone 2 possible

Technical data

Input data	
Voltage input signal	0.1 V ... 10 V 0.1 V ... 10.5 V (maximum range)
Total error of the voltage input maximum	± 10 mV
Current input signal	0.2 mA ... 20 mA 0.18 mA ... 21 mA (maximum range)
Total error of the current input maximum	± 20 µA
Input resistance	<28 Ω / >100 kΩ
Switching points	- / configurable via DIP switch (in 1.25% increments) and potentiometer (linearly up to 2% of the switching threshold set via the DIP switch)
Switching hysteresis	Off: approx. 0.5%, on: approx. 1%
Line error detection	Break U <50 mV, I <0.1 mA Short circuit U >10.8 V, I >21.1 mA
Switching output	
Contact type	1 PDT
Maximum switching current	≤4 A AC (cos phi = 1)
Mechanical service life	≤10 ⁷ cycles
Switching voltage	≤250 V AC ≤120 V DC
General data	
Supply voltage range	9.6 V DC ... 30 V DC (12 V DC ... 24 V DC (-20% ... +25%))
Current consumption, maximum	90 mA (10 V DC)
Current consumption, typical	38 mA (24 V DC)
Current draw	≤30 mA (30 V DC)
Power consumption	≤1.2 W
Power dissipation	<0.9 W
Temperature coefficient	0.01%/K
Step response (0 - 99%)	≤22 ms
Switching point accuracy	<0.1%
Maximum transmission error	0.1%
Electrical isolation	
Input/output	375 V (peak value in accordance with EN 60079-11)
Input/output/supply, DIN rail connector	300 V _{rms} (rated insulation voltage (overvoltage category II; degree of pollution 2, safe isolation as per EN 61010-1)) 2.5 kV (50 Hz, 1 min., test voltage)
Ambient temperature (operation)	-20°C ... 65°C (any mounting position)
Ambient temperature (storage/transport)	-40°C ... 85°C
Humidity	5% ... 95% (non-condensing)
Altitude	≤2,000 m
Inflammability class in accordance with UL 94	V0
Dimensions W/H/D	12.5 / 99 / 114.5 mm
Conformance/approvals	
Conformance	CE-compliant, additionally EN 61326
ATEX	Ex II 3 G Ex ec nC IIC T4 Gc
UL, USA/Canada	UL applied for
SIL in accordance with IEC 61508	2 (single-channel) 3 (two-channel)

Ordering data

Description	Type	Order No.	Pcs./Pkt.
Screw connection	MACX MCR-SL-UI-REL	2906169	1
Spring-cage connection	MACX MCR-SL-UI-REL-SP	2906170	1



Analog IN

Repeater power supplies, Ex i

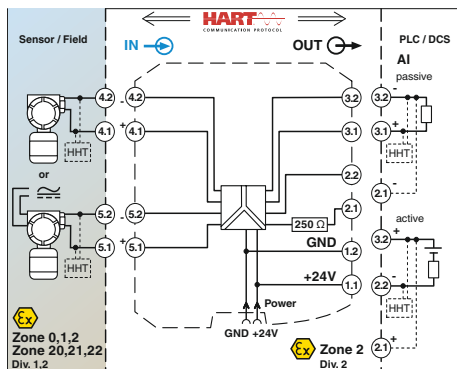
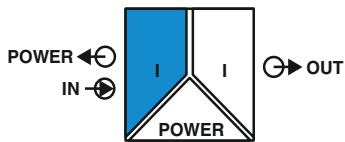

Repeater power supply and input signal conditioner

Functional Safety
 Ex: Ex i EAC Ex IEC Ex KC-s
 Housing width 12.5 mm

Repeater power supply and input signal conditioners for the operation of intrinsically safe (Ex i) 2-conductor measuring transducers, 4-conductor measuring transducers, and mA current sources installed in Ex areas.

- 0/4 to 20 mA input, [Ex ia] (powered or not powered)
- 0/4 to 20 mA output (active or passive)
- Bidirectional transmission of digital HART communication signals
- Plug-in screw or Push-in connection technology, with integrated sockets for HART communicators
- Terminal point with 250 Ω resistor to increase the HART impedance in the case of low-impedance systems
- 3-way electrical isolation
- Power supply via DIN rail connector possible
- Up to SIL 2 in accordance with IEC 61508
- Installation in zone 2 permitted

Notes:

Information about the supply and error evaluation module as well as about the DIN rail connectors and marking material can be found from page 175

Test plugs for test sockets can be found on page 177

Information on "Plug and play" connection using system cabling can be found from page 170

Input data

Input signal
 Transmitter supply voltage
 Voltage drop
 Output data
 Output signal

Load
 Output ripple

General data

Supply voltage range
 Current consumption

Power dissipation

Temperature coefficient
 Step response (10-90%)

Transmission error, typical
 Maximum transmission error
 Under-/overload range
 Electrical isolation

Input/output/power supply

Input/output
 Input/power supply

Ambient temperature range
 Humidity
 Status indication
 SMART communication
 Signal bandwidth
 Protocols supported
 Inflammability class in accordance with UL 94

Housing material
 Dimensions W/H/D
 Screw connection rigid / flexible / AWG
 Push-in connection rigid / flexible / AWG

Safety data as per ATEX

Maximum output voltage U_o
 Maximum output current I_o
 Maximum output power P_o
 Maximum voltage U_m

Conformance/approvals

Conformance
 ATEX

IECEX
 UL, USA/Canada

SIL in accordance with IEC 61508

4 mA ... 20 mA
 >16 V (20 mA)
 <3.5 V (in input signal conditioner operation)

4 mA ... 20 mA (active)
 4 mA ... 20 mA (14 ... 26 V ext. source voltage)
 <1,000 Ω (20 mA)
 <20 mV_{rms}

19.2 V DC ... 30 V DC (24 V DC -20%...+25%)
 <76 mA (24 V DC / 20 mA / 1,000 Ω) ;
 <55 mA (24 V DC / 20 mA / 250 Ω)
 <1.1 W (24 V DC / 20 mA / 1,000 Ω)
 <0.95 W (24 V DC / 20 mA / 250 Ω)
 <1.2 W (24 V DC / 20 mA / 0 Ω)

<0.01%/K
 <200 μs (for jump 4 mA ... 20 mA, load 600 Ω)

<0.05% (of final value)
 <0.1% (of final value)
 In accordance with NE 43

300 V_{rms} (rated insulation voltage (overvoltage category II); degree of pollution 2, safe isolation as per EN 61010-1)
 2.5 kV (50 Hz, 1 min., test voltage)

375 V (peak value in accordance with EN 60079-11)
 375 V (peak value in accordance with EN 60079-11)

-20°C ... 60°C (any mounting position)
 10% ... 95% (non-condensing)
 Green LED (supply voltage)
 Yes

as per HART specifications
 HART
 V0
 PA 6.6-FR
 12.5 / 112.5 / 114.5 mm
 0.2 ... 2.5 mm² / 0.2 ... 2.5 mm² / 24 - 14
 0.2 ... 1.5 mm² / 0.2 ... 1.5 mm² / 24 - 16

25.2 V
 93 mA
 587 mW
 253 V AC (125 V DC)

CE-compliant, additionally EN 61326
 Ex II (1) G [Ex ia Ga] IIC
 Ex II (1) D [Ex ia Da] IIIC
 Ex II 3 (1) G Ex nA [ia Ga] IIC T4 Gc
 Ex I (M1) [Ex ia Ma] I
 [Ex ia Ga] IIC, [Ex ia Da] IIIC, Ex nA [ia Ga] IIC T4 Gc
 UL 61010 Listed
 Class I Div 2; IS for Class I, II, III Div 1
 2

Ordering data

Description

Repeater power supply, HART®-transparent, intrinsically safe input

Screw connection
 Push-in connection

Type

MACX MCR-EX-SL-RPSSI-I
 MACX MCR-EX-SL-RPSSI-SP

Order No.

2865340
 2924016

Pcs./Pkt.

1
 1

Analog IN
Repeater power supplies, Ex i

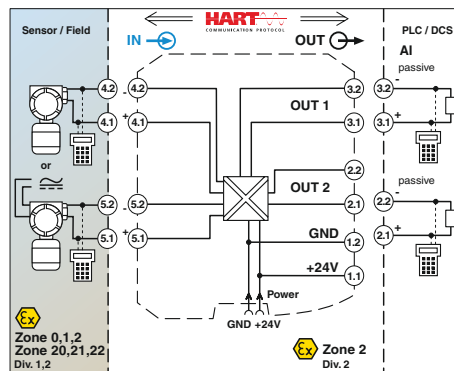
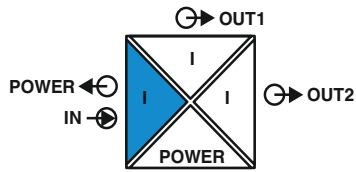

Repeater power supply and input signal conditioner, with two electrically isolated outputs

Functional Safety
Ex: EAC Ex IEC 61508
Housing width 12.5 mm

Repeater power supply and input signal conditioners for the operation of intrinsically safe (Ex i) 2-conductor measuring transducers, 4-conductor measuring transducers, and mA current sources installed in Ex areas.

- 0/4 to 20 mA input, [Ex ia] (powered or not powered)
- Two electrically isolated outputs, 0/4 to 20 mA (active)
- Bidirectional transmission of digital HART communication signals (both outputs)
- Plug-in screw or Push-in connection technology, with integrated sockets for HART communicators
- 4-way electrical isolation
- Power supply via DIN rail connector possible
- Up to SIL 2 in accordance with IEC 61508
- PL d in accordance with EN ISO 13849-1
- Installation in zone 2 permitted

Notes:
Information about the supply and error evaluation module as well as about the DIN rail connectors and marking material can be found from page 175
Test plugs for test sockets can be found on page 177
Information on "Plug and play" connection using system cabling can be found from page 170

Input data	Input signal Transmitter supply voltage Voltage drop
Output data	Output signal (per output)
Load	Output ripple
General data	Supply voltage range Current consumption Power dissipation Temperature coefficient Step response (10-90%) Transmission error, typical Maximum transmission error Under-/overload range Electrical isolation
Ambient temperature range	Status indication SMART communication (per output) Protocols supported Housing material Dimensions W/H/D Screw connection rigid / flexible / AWG Push-in connection rigid / flexible / AWG
Safety data as per ATEX	Maximum output voltage U _o Maximum output current I _o Maximum output power P _o Maximum voltage U _m
Conformance/approvals	Conformance ATEX IECEX UL, USA/Canada SIL in accordance with IEC 61508
Input/output/power supply	300 V _{rms} (rated insulation voltage (overvoltage category II; degree of pollution 2, safe isolation as per EN 61010-1)) 2.5 kV (50 Hz, 1 min., test voltage)
Input/output	375 V (peak value in accordance with EN 60079-11)
Input/power supply	375 V (peak value in accordance with EN 60079-11)
Output 1/output 2	1.5 kV AC (50 Hz, 1 min., test voltage) -20°C ... 60°C (any mounting position) Green LED (PWR supply voltage) Yes HART PA 6.6-FR 12.5 / 99 / 114.5 mm 0.2 ... 2.5 mm ² / 0.2 ... 2.5 mm ² / 24 - 14 0.2 ... 1.5 mm ² / 0.2 ... 1.5 mm ² / 24 - 16

Technical data		
4 mA ... 20 mA / 0 mA ... 20 mA	>16 V (20 mA)	Approx. 3.9 V (in input signal conditioner operation)
4 mA ... 20 mA (output 1 and output 2 active)	<450 Ω (20 mA)	<20 mV _{rms}
19.2 V DC ... 30 V DC (24 V DC -20%...+25%)	<75 mA (24 V DC / 20 mA)	<1.45 W (24 V DC / 20 mA)
<0.01%/K	1.3 ms (for jump 4 mA ... 20 mA, typical)	<0.05% (of final value)
<0.1% (of final value)	In accordance with NE 43	
300 V _{rms} (rated insulation voltage (overvoltage category II; degree of pollution 2, safe isolation as per EN 61010-1))	2.5 kV (50 Hz, 1 min., test voltage)	
375 V (peak value in accordance with EN 60079-11)	375 V (peak value in accordance with EN 60079-11)	1.5 kV AC (50 Hz, 1 min., test voltage)
-20°C ... 60°C (any mounting position)	Green LED (PWR supply voltage)	Yes
HART	PA 6.6-FR	12.5 / 99 / 114.5 mm
0.2 ... 2.5 mm ² / 0.2 ... 2.5 mm ² / 24 - 14	0.2 ... 1.5 mm ² / 0.2 ... 1.5 mm ² / 24 - 16	
25.2 V	93 mA	587 mW
253 V AC (125 V DC)		
CE-compliant, additionally EN 61326	Ex II (1) G [Ex ia Ga] IIC	Ex II (1) D [Ex ia Da] IIIC
Ex II (1) G Ex nA [ia Ga] IIC T4 Gc	[Ex ia Ga] IIC, [Ex ia Da] IIIC, Ex nA [ia Ga] IIC T4 Gc	Class I Div 2; IS for Class I, II, III Div 1
2		

Description	Type	Order No.	Pcs./Pkt.
Repeater power supply, HART®-transparent, intrinsically safe input	Screw connection	MACX MCR-EX-SL-RPSSI-2I	2865366
	Push-in connection	MACX MCR-EX-SL-RPSSI-2I-SP	2924236
With just one HART-transparent output	Screw connection	MACX MCR-EX-SL-RPSSI-2I-1S	2908855
	Push-in connection	MACX MCR-EX-SL-RPSSI-2I-1S-SP	2908856

Ordering data			
Type	Order No.	Pcs./Pkt.	
Screw connection	MACX MCR-EX-SL-RPSSI-2I	2865366	1
Push-in connection	MACX MCR-EX-SL-RPSSI-2I-SP	2924236	1
Screw connection	MACX MCR-EX-SL-RPSSI-2I-1S	2908855	1
Push-in connection	MACX MCR-EX-SL-RPSSI-2I-1S-SP	2908856	1

Analog IN

Repeater power supplies, Ex i

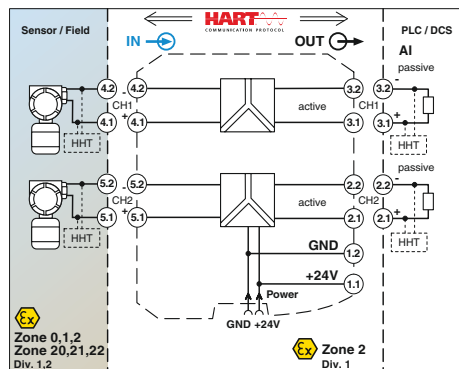
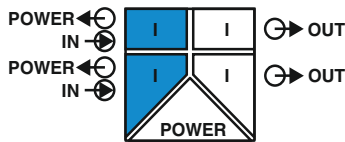

2-channel repeater power supply

Functional Safety
 Ex: EAC Ex IEC Ex KC-s
 Housing width 12.5 mm

Repeater power supply for the operation of intrinsically safe (Ex i) 2-conductor measuring transducers installed in the Ex area.

- 2-channel
- 4 to 20 mA input, [Ex ia] (powered)
- 4 to 20 mA output (active)
- Bidirectional transmission of digital HART communication signals
- Plug-in screw or Push-in connection technology, with integrated sockets for HART communicators
- Safe 3-way electrical isolation
- Power supply via DIN rail connector possible
- Up to SIL 3 in accordance with IEC 61508
- PL d in accordance with EN ISO 13849-1
- Installation in zone 2 permitted

Notes:
Information on the supply and error evaluation module, DIN rail connectors, system cabling, and marking material can be found from page 175
Test plugs for test sockets can be found on page 177
Information on "Plug and play" connection using system cabling can be found from page 170

Input data	
Input signal	
Transmitter supply voltage	
Underload/overload signal range	
Output data	
Output signal	
Load	
Underload/overload signal range	
General data	
Supply voltage range	
Current consumption	
Power dissipation	
Temperature coefficient	
Step response (10-90%)	
Transmission error, typical	
Maximum transmission error	
Electrical isolation	Input/output, power supply
	Input/output
	Input/power supply
	Output 1/output 2/ power supply
Ambient temperature range	
Status indication	
SMART communication	
Signal bandwidth	
Protocols supported	
Housing material	
Dimensions W/H/D	
Screw connection rigid / flexible / AWG	
Push-in connection rigid / flexible / AWG	
Safety data as per ATEX	
Maximum output voltage U _o	25.2 V
Maximum output current I _o	93 mA
Maximum output power P _o	587 mW
Maximum voltage U _m	253 V AC (125 V DC)
Conformance/approvals	
Conformance	CE-compliant, additionally EN 61326
ATEX	Ex II (1) G [Ex ia Ga] IIC Ex II (1) D [Ex ia Da] IIIC Ex II 3(1) G Ex nA [ia Ga] IIC T4 Gc [Ex ia Ga] IIC, [Ex ia Da] IIIC, Ex nA [ia Ga] IIC T4 Gc Class I Div 2; IS for Class I, II, III Div 1 3
IECEX	
UL, USA/Canada	
SIL in accordance with IEC 61508	

Technical data

per channel	
4 mA ... 20 mA	
>16 V (20 mA)	
0 mA ... 24 mA	
per channel	
4 mA ... 20 mA (active)	
≤450 Ω (20 mA)	
0 mA ... 24 mA	
19.2 V DC ... 30 V DC (24 V DC -20%...+25%)	
<100 mA (24 V / 20 mA)	
<1.4 W (at 24 V DC / 20 mA)	
<0.01%/K	
<1.3 ms (for 4 mA ... 20 mA step)	
<0.05% (of final value)	
<0.1% (of final value)	
300 V _{rms} (rated insulation voltage (overvoltage category II; degree of pollution 2, safe isolation as per EN 61010-1))	
2.5 kV (50 Hz, 1 min., test voltage)	
375 V (peak value in accordance with EN 60079-11)	
375 V (peak value in accordance with EN 60079-11)	
1.5 kV (50 Hz, 1 min., test voltage)	
-20°C ... 60°C (any mounting position)	
Green LED (supply voltage)	
Yes	
as per HART specifications	
HART	
PA 6.6-FR	
12.5 / 99 / 114.5 mm	
0.2 ... 2.5 mm ² / 0.2 ... 2.5 mm ² / 24 - 14	
0.2 ... 1.5 mm ² / 0.2 ... 1.5 mm ² / 24 - 16	
25.2 V	
93 mA	
587 mW	
253 V AC (125 V DC)	
Ordering data	
CE-compliant, additionally EN 61326	
Ex II (1) G [Ex ia Ga] IIC	
Ex II (1) D [Ex ia Da] IIIC	
Ex II 3(1) G Ex nA [ia Ga] IIC T4 Gc	
[Ex ia Ga] IIC, [Ex ia Da] IIIC, Ex nA [ia Ga] IIC T4 Gc	
Class I Div 2; IS for Class I, II, III Div 1	
3	

Description
Repeater power supply , 2-channel, HART®-transparent, intrinsically safe input
Screw connection
Push-in connection

Type	Order No.	Pcs./Pkt.
MACX MCR-EX-SL-RPSS-2I-2I	2865382	1
MACX MCR-EX-SL-RPSS-2I-2I-SP	2924676	1

Analog IN

Repeater power supplies with wide range power supply, Ex i

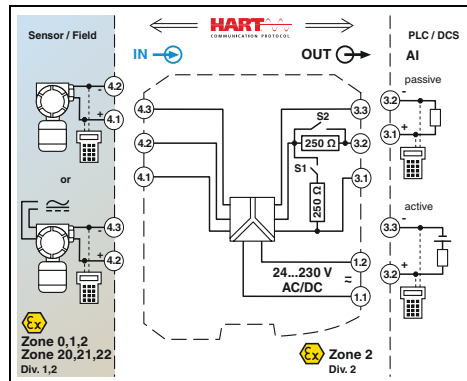
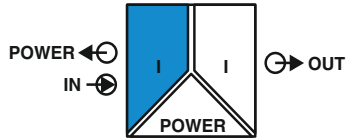

Repeater power supply and input signal conditioner, wide-range power supply

Ex: EAC Ex IEC Ex II Ex III Ex IV Ex V // Applied for: GL
Housing width 17.5 mm

Repeater power supply and input signal conditioners for the operation of intrinsically safe (Ex i) 2-conductor measuring transducers, 4-conductor measuring transducers, and mA current sources installed in Ex areas.

- 0/4 to 20 mA input, [Ex ia] (powered or not powered)
- 0/4 to 20 mA output (active or passive), 0/1 to 5 V, can be selected via DIP switch
- Bidirectional transmission of digital HART communication signals
- Plug-in screw or Push-in connection technology, with integrated sockets for HART communicators
- 250 Ω resistor that can be activated via DIP switches to increase the HART impedance in the case of low-impedance systems
- 3-way electrical isolation
- Wide-range power supply of 19.2 to 253 V AC/DC
- Up to SIL 2 in accordance with IEC 61508
- Installation in zone 2 permitted

Notes:
Information on marking material can be found on page 178
Test plugs for test sockets can be found on page 177

Input data	Input signal Transmitter supply voltage Voltage drop
Output data	Output signal (configurable using the DIP switch)
Load	Output ripple
General data	Supply voltage range Current consumption Power dissipation Temperature coefficient Step response (10-90%) Transmission error, typical Maximum transmission error Under-/overload range Electrical isolation
Ambient temperature range	Humidity Status indication SMART communication Signal bandwidth Protocols supported Inflammability class in accordance with UL 94 Housing material Dimensions W/H/D
Safety data as per ATEX	Screw connection rigid / flexible / AWG Push-in connection rigid / flexible / AWG
Conformance/approvals	Conformance ATEX IECEX UL, USA/Canada SIL in accordance with IEC 61508

Technical data	4 mA ... 20 mA >16 V (20 mA) <3.5 V (in input signal conditioner operation)
	4 mA ... 20 mA (active) 4 mA ... 20 mA (14 ... 26 V ext. source voltage) 1 V ... 5 V (internal resistance, 250 Ω, 0.1%) Configurable via DIP switches <600 Ω (20 mA) <20 mV _{rms}
	24 V ... 230 V AC/DC (-20%/+10%, 50/60 Hz) <80 mA (24 V DC / 20 mA) <1.6 W (24 V DC/ 20 mA) <0.01%/K <600 μs (for 4 mA ... 20 mA step) <0.05% (of final value) <0.1% (of final value) In accordance with NE 43
	300 V _{rms} (rated insulation voltage (overvoltage category II; degree of pollution 2, safe isolation as per EN 61010-1)) 2.5 kV (50 Hz, 1 min., test voltage)
	375 V (peak value in accordance with EN 60079-11) 375 V (peak value in accordance with EN 60079-11) -20°C ... 60°C (any mounting position) 10% ... 95% (non-condensing) Green LED (supply voltage) Yes as per HART specifications HART V0 PA 6.6-FR 17.5 / 99 / 114.5 mm 0.2 ... 2.5 mm ² / 0.2 ... 2.5 mm ² / 24 - 14 0.2 ... 1.5 mm ² / 0.2 ... 1.5 mm ² / 24 - 16
	25.2 V 93 mA 587 mW 253 V AC/DC (supply terminals) 253 V AC (output terminals) 125 V DC (output terminals)
	CE-compliant, additionally EN 61326 Ex II (1) G [Ex ia Ga] IIC/IIB Ex II (1) D [Ex ia Da] IIIC Ex II 3(1) G Ex nA [ia Ga] IIC/IIB T4 Gc [Ex ia Ga] IIC/IIB, [Ex ia Da] IIIC, Ex nA [ia Ga] IIC/IIB T4 Gc Class I Div 2; IS for Class I, II, III Div 1 2

Description	Repeater power supply, 2-channel, HART®-transparent, intrinsically safe input
	Screw connection Push-in connection

Ordering data	Type	Order No.	Pcs./Pkt.
	MACX MCR-EX-SL-RPSSI-I-UP	2865793	1
	MACX MCR-EX-SL-RPSSI-I-UP-SP	2924029	1

Temperature

Temperature transducers, Ex i

new

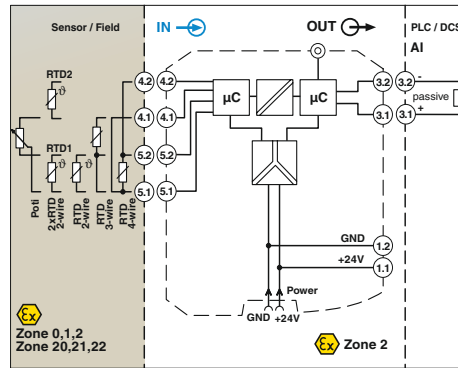
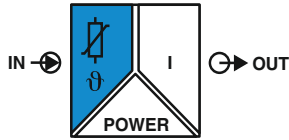

Temperature transducer for resistance thermometers and resistance-type sensors

Housing width 12.5 mm

Programmable temperature transducer for intrinsically safe operation of resistance thermometers and resistance-type sensors installed in Ex areas. The measured values are converted into a linear 0 to 20 mA or 4 to 20 mA signal.

- Input for resistance thermometers and resistance-type sensors, [Ex ia]
- 0 to 20 mA or 4 to 20 mA output
- Configuration via software (FDT/DTM): Sensor type, connection method, measuring range, measuring unit, filter, alarm signal, and output range
- Programming during operation with Ex measuring circuit connected and also voltage-free using IFS-USB-PROG-ADAPTER programming adapter
- Status indicator for supply voltage, cable, sensor, and module errors
- 3-way electrical isolation
- Power supply via DIN rail connector possible
- Installation in zone 2 permitted

Input data

Resistance thermometers
Resistor
Cable resistance
Sensor input current

Measuring range span

Output data

Output signal
Load
Behavior in the event of a sensor error
Output ripple

General data

Supply voltage range
Current draw
Power dissipation
Temperature coefficient
Step response (0 - 99%)

Transmission error, total
ZERO / SPAN adjustment
Electrical isolation

Input/output/power supply

Input/output
Input/power supply

Ambient temperature range
Humidity
Status indication

Inflammability class in accordance with UL 94
Housing material
Dimensions W/H/D
Screw connection rigid / flexible / AWG
Push-in connection rigid / flexible / AWG

Safety data as per ATEX

Maximum output voltage U_o
Maximum output current I_o
Maximum output power P_o

Conformance/approvals

Conformance
ATEX

IECEX
UL, USA/Canada

Sensors (2-, 3-, 4-conductor)
0 Ω ... 50 kΩ
≤50 Ω per cable
10 µA ... 210 µA (up to 2 x 210 µA for 3-conductor)

≥50 K

0 mA ... 20 mA / 4 mA ... 20 mA (SIL)
≤600 Ω
As per NE 43 or can be freely defined
<15 µA_{pp}

19.2 V DC ... 30 V DC (24 V DC -20%...+25%)
≤40 mA (24 V DC)
≤0.74 W
0.01%/K
Typically 1 s
≤1.7 s
0.1% x 1,000 [K]/measuring span
± 5% / ± 5%

300 V_{rms} (rated insulation voltage (overvoltage category II); degree of pollution 2, safe isolation as per EN 61010-1)
2.5 kV (50 Hz, 1 min., test voltage)

375 V (peak value in accordance with EN 60079-11)
375 V (peak value in accordance with EN 60079-11)
-40°C ... 70°C (any mounting position)
5% ... 95% (non-condensing)
Green LED (supply voltage, PWR)
Red LED, flashing 2.4 Hz (cable error, sensor error on input or output, ERR)
Red LED, flashing 1.2 Hz (service operation, ERR)
Red LED, permanently on (module error, ERR)

V0
PA 6.6-FR
12.5 / 112.5 / 114.5 mm
0.2 ... 2.5 mm² / 0.2 ... 2.5 mm² / 24 - 14
0.2 ... 1.5 mm² / 0.2 ... 1.5 mm² / 24 - 16

6 V
16.6 mA
9.7 mW

CE-compliant, additionally EN 61326
Ex II (1) G [Ex ia Ga] IIC/IIB
Ex II (1) D [Ex ia Da] IIIC
Ex II 3(1) G Ex ec ic [ia Ga] IICT4 Gc X
[Ex ia Ga] IIC, [Ex ia Da] IIIC, Ex ec ic [ia Ga] IIC T4 Gc

Ordering data

Type	Order No.	Pcs./Pkt.
MACX MCR-EX-RTD-I	1050222	1
MACX MCR-EX-RTD-I-SP	1050252	1
MACX MCR-EX-RTD-I-C	1052463	1
MACX MCR-EX-RTD-I-SP-C	1052652	1

Accessories

IFS-USB-PROG-ADAPTER	2811271	1
----------------------	---------	---

Programming adapter for configuring modules with S-PORT interface

MACX Analog – Ex i signal conditioners with functional safety

Order key for MACX MCR-EX-RTD-I-(SP)-C temperature transducers (standard configuration entered as an example)

Order No.	SIL ON/OFF	Sensor type	Measuring unit	Connection technology	Measuring range:		Output signal	Sliding mean value	Alarm signal, short circuit	Alarm signal, sensor break	Factory calibration certificate
					Start	End					
1052463	ON	PT100	C	4	-50	150	OUT02	1	I000	I000	NONE
1052463 ≙ MACX MCR-EX-RTD-I-C	ON ≙ Active NONE ≙ Not active	See below	Celsius [C] Ω [O] Millivolts [V]	2 ≙ 2-conductor 3 ≙ 3-conductor 4 ≙ 4-conductor	See below	See below	0...20 mA [OUT01] 4...20 mA [OUT02] 0...5 mA [OUT15] 0...10 mA [OUT16] 1...5 mA [OUT25] 2...10 mA [OUT26]	1 - 10	0 mA [I000] 3.5 mA [I035] 21.5 mA [I215]	0 mA [I000] 3.5 mA [I035] 21.5 mA [I215]	NONE ≙ Without FCC YES ≙ With FCC (a fee is charged) YESPLUS ≙ FCC with 5 measuring points (a fee is charged)

Resistance temperature detector (RTD)

PT50	≙ Pt 50 IEC60751	°C	-200	850	20k
PT100	≙ Pt 100 IEC60751	°C	-200	850	20k
PT200	≙ Pt 200 IEC60751	°C	-200	850	20k
PT500	≙ Pt 500 IEC60751	°C	-200	850	20k
PT1000	≙ Pt 1000 IEC60751	°C	-200	850	20k
PT2000	≙ Pt 2000 IEC60751	°C	-200	850	20k
PT5000	≙ Pt 5000 IEC60751	°C	-200	850	20k
PT50S	≙ PT50 SAMA RC21-4-1966	°C	-200	850	20k
PT100S	≙ PT100 SAMA RC21-4-1966	°C	-200	850	20k
PT200S	≙ PT200 SAMA RC21-4-1966	°C	-200	850	20k
PT500S	≙ PT500 SAMA RC21-4-1966	°C	-200	850	20k
PT1000S	≙ PT1000 SAMA RC21-4-1966	°C	-200	850	20k
PT2000S	≙ PT2000 SAMA RC21-4-1966	°C	-200	850	20k
PT5000S	≙ PT5000 SAMA RC21-4-1966	°C	-200	850	20k
PT100G	≙ PT100 G GOST 6651-2009 (α=0.00391)	°C	-200	850	20k
PT200G	≙ PT200 G GOST 6651-2009 (α=0.00391)	°C	-200	850	20k
PT500G	≙ PT500 G GOST 6651-2009 (α=0.00391)	°C	-200	850	20k
PT1000G	≙ PT1000 G GOST 6651-2009 (α=0.00391)	°C	-200	850	20k
PT100J	≙ Pt 100 JIS C1604/1997	°C	-200	850	20k
PT200J	≙ Pt 200 JIS C1604/1997	°C	-200	850	20k
PT500J	≙ Pt 500 JIS C1604/1997	°C	-200	850	20k
PT1000J	≙ Pt 1000 JIS C1604/1997	°C	-200	850	20k
NI100	≙ Ni100 DIN 43760	°C	-60	250	20k
NI200	≙ Ni200 DIN 43760	°C	-60	250	20k
NI500	≙ Ni500 DIN 43760	°C	-60	250	20k
NI1000	≙ Ni1000 DIN 43760	°C	-60	250	20k
NI100S	≙ Ni100 SAMA RC21-4-1966	°C	-60	180	20k
NI200S	≙ Ni200 SAMA RC21-4-1966	°C	-60	180	20k
NI500S	≙ Ni500 SAMA RC21-4-1966	°C	-60	180	20k
NI1000S	≙ Ni1000 SAMA RC21-4-1966	°C	-60	180	20k
NI1000L	≙ Ni1000 Landis&Gyr	°C	-50	160	20k
CU10	≙ CU10 SAMA RC21-4-1966	°C	-70	500	100k
CU50	≙ CU 50 GOST 6651-2009 (α=0.00428)	°C	-50	200	100k
CU100	≙ CU 100 GOST 6651-2009 (α=0.00428)	°C	-50	200	100k
CU53	≙ CU 53 GOST 6651-2009 (α=0.00426)	°C	-50	180	100k
KTY81	≙ KTY81 KTY81-110 (Philips)	°C	-55	150	20k
KTY84	≙ KTY81 KTY84-130 (Philips)	°C	-40	300	20k
RES02	≙ Resistance 0...75 Ω	Ω	0	75	10% of the selected measuring range
RES03	≙ Resistance 0...150 Ω	Ω	0	150	
RES04	≙ Resistance 0...300 Ω	Ω	0	300	
RES05	≙ Resistance 0...600 Ω	Ω	0	600	
RES06	≙ Resistance 0...1,200 Ω	Ω	0	1200	
RES07	≙ Resistance 0...2,400 Ω	Ω	0	2400	
RES08	≙ Resistance 0...4,800 Ω	Ω	0	4800	
RES09	≙ Resistance 0...6,250 Ω	Ω	0	6250	
RES10	≙ Resistance 0...12,500 Ω	Ω	0	12500	
RES11	≙ Resistance 0...25,000 Ω	Ω	0	25000	
RES12	≙ Resistance 0...50,000 Ω	Ω	0	50,000	

Other setting options can be configured with the IFS-CONF software:

- Freely configurable user characteristic curve with 30 support points
- Output behavior in the event of a short circuit, sensor break or over-range/under-range can be freely configured or set in accordance with NE43 (standard configuration: NE43 upscale)
- Filter setting (standard configuration: 1)
- Restart after failsafe (standard configuration: ON)
- Switching behavior: switching output (limit values, times, etc.) (standard configuration: OFF)

Remote resistance-type sensors (R) (2-, 3-, 4-conductor)

Temperature conversion guide for °C to °F:

$$T [°F] = \frac{9}{5} T [°C] + 32$$

Temperature

Temperature transducers, Ex i

new

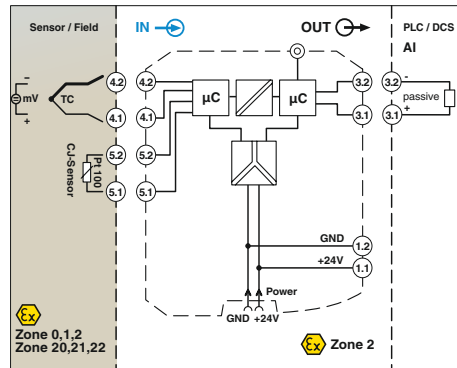
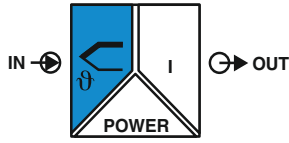

Temperature transducer for thermocouples

Housing width 12.5 mm

Programmable temperature transducer for intrinsically safe operation of thermocouples and mV sources installed in Ex areas. The measured values are converted into a linear 0 to 20 mA or 4 to 20 mA signal.

- Input for thermocouples and mV sources, [Ex ia]
- 0 to 20 mA or 4 to 20 mA output
- Configuration via software (FDT/DTM): Sensor type, connection method, measuring range, measuring unit, filter, alarm signal, and output range
- Programming during operation with Ex measuring circuit connected and also voltage-free using IFS-USB-PROG-ADAPTER programming adapter
- Status indicator for supply voltage, cable, sensor, and module errors
- 3-way electrical isolation
- Power supply via DIN rail connector possible
- Installation in zone 2 permitted

Input data

Thermocouple sensors

Voltage

Measuring range span

Output data

Output signal

Load

Behavior in the event of a sensor error

Output ripple

General data

Supply voltage range

Current consumption

Power dissipation

Temperature coefficient

Step response (0 - 99%)

Transmission error, total

Cold junction errors

ZERO / SPAN adjustment

Electrical isolation

Input/output/power supply

Input/output

Input/power supply

Ambient temperature range

Humidity

Status indication

Inflammability class in accordance with UL 94

Housing material

Dimensions W/H/D

Screw connection rigid / flexible / AWG

Safety data as per ATEX

Maximum output voltage U_o

Maximum output current I_o

Maximum output power P_o

Maximum voltage U_m

Conformance/approvals

Conformance

ATEX

IECEX

UL, USA/Canada

Technical data

B, E, J, K, N, R, S, T, L, U, C, D, A-1, A-2, A-3, M, Lr

-1,000 mV ... 1,000 mV

Min. 50 K with thermocouple, 10% of the nominal span of the respective range with mV sources

0 mA ... 20 mA / 4 mA ... 20 mA (SIL)

≤600 Ω

As per NE 43 or can be freely defined

<15 μA_{pp}

19.2 V DC ... 30 V DC (24 V DC -20%...+25%)

<40 mA (24 V DC)

≤0.74 W

0.01%/K

Typically 700 ms

≤1,000 ms

0.1%

± 1 K

± 5% / ± 5%

300 V_{rms} (rated insulation voltage (overvoltage category II; degree of pollution 2, safe isolation as per EN 61010-1))
2.5 kV (50 Hz, 1 min., test voltage)

375 V (peak value in accordance with EN 60079-11)

375 V (peak value in accordance with EN 60079-11)

-40°C ... 70°C (any mounting position)

5% ... 95% (non-condensing)

Green LED (supply voltage, PWR)

Red LED, flashing 2.4 Hz (cable error, sensor error on input or output, ERR)

Red LED, flashing 1.2 Hz (service operation, ERR)

Red LED, permanently on (module error, ERR)

V0

PA 6.6-FR

12.5 / 112.5 / 114.5 mm

0.2 ... 2.5 mm² / 0.2 ... 2.5 mm² / 24 - 14

6 V

4.3 mA

9.7 mW

253 V AC (125 V DC)

CE-compliant, additionally EN 61326

Ex II (1) G [Ex ia Ga] IIC/IIB

Ex II (1) D [Ex ia Da] IIIC

Ex II 3(1) G Ex ec ic [ia Ga] IIC T4 Gc X

[Ex ia Ga] IIC, [Ex ia Da] IIIC, Ex ec ic [ia Ga] IIC T4 Gc

Ordering data

Type	Order No.	Pcs./Pkt.
MACX MCR-EX-TC-I	1050233	1
MACX MCR-EX-TC-I-C	1052458	1

Accessories

IFS-USB-PROG-ADAPTER	2811271	1
IOA MCR-CJC-PT100	1085776	1

Programming adapter for configuring modules with S-PORT interface
Cold junction compensation connector for thermocouples

MACX Analog – Ex i signal conditioners with functional safety

Order key for MACX MCR-EX-TC-I-C temperature transducers (standard configuration entered as an example)

Order No.	SIL	Sensor type	Measuring unit	Cold junction compensation	Measuring range:		Output signal	Sliding mean value	Alarm signal, short circuit	Alarm signal, sensor break	Factory calibration certificate	
					Start	End					NONE	YES
1052458	ON	K	C	ON	-50	150	OUT02	1	I000	I000	NONE	
1052458 ≙ MACX MCR-EX-TC-I-C	ON ≙ Active NONE ≙ Not active ON only with output range = OUT02	See below	Celsius [C] Ω [O] Millivolts [V]	ON OFF	See below	See below	0...20 mA [OUT01] 4...20 mA [OUT02] 0...5 mA [OUT15] 0...10 mA [OUT16] 1...5 mA [OUT25] 2...10 mA [OUT26]	1 - 10	0 mA [I000] 3.5 mA [I035] 21.5 mA [I215]	0 mA [I000] 3.5 mA [I035] 21.5 mA [I215]	NONE ≙ Without FCC YES ≙ With FCC (a fee is charged) YESPLUS ≙ FCC with 5 measuring points (a fee is charged)	

Thermocouples (TC)

A1G	≙ A-1 GOST 8.585-2001	°C	0	2,500	50k
A2G	≙ A-2 GOST 8.585-2001	°C	0	1,800	50k
A3G	≙ A-3 GOST 8.585-2001	°C	0	1,800	50k
B	≙ B IEC584-1 (Pt30Rh-Pt6Rh)	°C	500	1,820	50k
C	≙ C ASTM E988	°C	0	2,315	50k
D	≙ DA ASTM E988(2002)	°C	0	2,315	50k
E	≙ E IEC584-1 (NiCr-CuNi)	°C	-230	1,000	50k
J	≙ J IEC584-1 (Fe-CuNi)	°C	-210	1,200	50k
K	≙ K IEC584-1 (NiCr-Ni)	°C	-250	1,372	50k
MG	≙ MG GOST 8.585-2001	°C	-200	100	50k
N	≙ N IEC 584-1 (NiCrSi-NiSi)	°C	-200	1,300	50k
R	≙ R IEC 584-1 (Pt13Rh-Pt)	°C	-50	1,768	50k
S	≙ S IEC 584-1 (Pt10Rh-Pt)	°C	-50	1,768	50k
T	≙ T IEC 584-1 (Cu-CuNi)	°C	-200	400	50k
L	≙ L DIN 43760 (Fe-CuNi)	°C	-200	900	50k
LG	≙ LG GOST 8.585-2001	°C	-200	800	50k
U	≙ U DIN 43760 (Cu-CuNi)	°C	-200	600	50k
V04	≙ Voltage -1,000 mV...+1,000 mV	mV	-1,000	1,000	10% of nominal span
V05	≙ Voltage -500 mV...+500 mV	mV	-500	500	
V06	≙ Voltage -250 mV...+250 mV	mV	-250	250	
V07	≙ Voltage -125 mV...+125 mV	mV	-125	125	
V08	≙ Voltage -60 mV...+60 mV	mV	-60	60	
V09	≙ Voltage -30 mV...+30 mV	mV	-30	30	
V10	≙ Voltage -15 mV...+15 mV	mV	-15	150	

Smallest measuring range span

Other setting options can be configured with the IFS-CONF software:

- Freely configurable user characteristic curve with 30 support points
- Output behavior in the event of a short circuit, sensor break or overrange/underrange can be freely configured or set in accordance with NE43 (standard configuration: NE43 upscale)
- Filter setting (standard configuration: 1)
- Restart after failsafe (standard configuration: ON)
- Switching behavior: switching output (limit values, times, etc.) (standard configuration: OFF)

Temperature conversion guide for °C to °F:

$$T [°F] = \frac{9}{5} T [°C] + 32$$

Temperature

Temperature transducers, Ex i

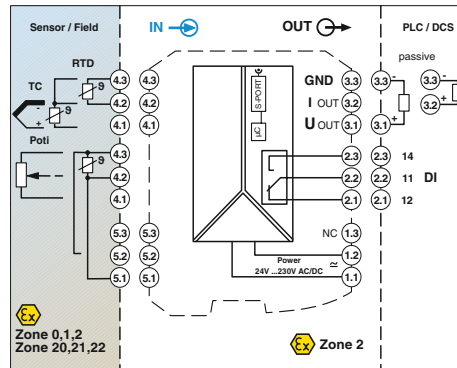
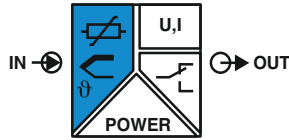

Temperature transducer, universal, with switching output, wide range supply

Functional Safety
 Ex: EAC Ex IEC 61508, KC-s
 Housing width 17.5 mm

Universal temperature transducer with freely configurable properties for intrinsically safe operation of resistance thermometers, thermocouples, resistance-type sensors, and potentiometers installed in Ex areas

- Input for resistance thermometers, thermocouples, resistance-type sensors, potentiometers, and mV sources, [Ex ia]
- Measure differential temperatures
- Freely programmable input and output
- Option of inverse output signal ranges
- Relay switching output
- Configuration via software (FDT-DTM)
- Programming during operation with Ex measuring circuit connected and also voltage-free using IFS-USB-PROG-ADAPTER programming adapter
- Plug-in screw or Push-in connection technology
- Cold junction compensation with separate connector
- Wide-range power supply of 19.2 to 253 V AC/DC
- Status indicator for supply voltage, cable, sensor, and module errors
- Up to SIL 2 in accordance with IEC 61508
- PL d in accordance with EN ISO 13849-1
- Installation in zone 2 permitted

Notes:
To order a product with an order configuration, enter the required configuration by referring to the adjacent order key.
The configuration software can be downloaded from the Internet (phoenixcontact.net/products).
For information on the programming adapter, refer to page 111

Input data	Resistance thermometers Thermocouple sensors
Resistor	Potentiometer
Output data	Output signal
Maximum output signal	Load R_B
Behavior in the event of a sensor error	Switching output
Switching output	Contact type
Contact type	Contact material
Contact material	Max. switching voltage
Max. switching voltage	Maximum switching current
Maximum switching current	General data
General data	Supply voltage range
Supply voltage range	Power consumption
Power consumption	Temperature coefficient
Temperature coefficient	Transmission error, total
Transmission error, total	Electrical isolation
Electrical isolation	Input/output/power supply
Input/output/power supply	Input/output
Input/output	Input/power supply
Input/power supply	Input/switching output
Input/switching output	Output/supply
Output/supply	Ambient temperature range
Ambient temperature range	Humidity
Humidity	Inflammability class in accordance with UL 94
Inflammability class in accordance with UL 94	Housing material
Housing material	Dimensions W/H/D
Dimensions W/H/D	Screw connection rigid / flexible / AWG
Screw connection rigid / flexible / AWG	Push-in connection rigid / flexible / AWG
Push-in connection rigid / flexible / AWG	Safety data as per ATEX
Safety data as per ATEX	Maximum output voltage U_o
Maximum output voltage U_o	Maximum output current I_o
Maximum output current I_o	Maximum output power P_o
Maximum output power P_o	Conformance/approvals
Conformance/approvals	Conformance
Conformance	ATEX
ATEX	IECEX
IECEX	SIL in accordance with IEC 61508

Technical data

Pt, Ni, Cu sensors: 2-, 3-, 4-conductor
 B, E, J, K, N, R, S, T, L, U, CA, DA, A1G, A2G, A3G, MG, LG

0 Ω ... 50 kΩ
 0 Ω ... 50 kΩ
 -1,000 mV ... 1,000 mV

U output I output
 4 mA ... 20 mA (in the case of SIL; further free configuration without SIL)

± 11 V 22 mA
 ≥ 10 kΩ ≤ 600 Ω (20 mA)
 In accordance with NE 43 or freely configurable

Switching output
 1 PDT
 AgSnO₂, hard gold-plated
 30 V AC (30 V DC)
 0.5 A (30 V AC) / 1 A (30 V DC)

24 V ... 230 V AC/DC (-20%/+10%, 50/60 Hz)
 <1.5 W
 0.01%/K
 <0.1% (e.g., for Pt 100, 300 K span, 4 ... 20 mA)

2.5 kV (50 Hz, 1 min., test voltage)
 375 V (peak value in accordance with EN 60079-11)
 375 V (peak value in accordance with EN 60079-11)
 375 V (peak value in accordance with EN 60079-11)
 300 V_{rms} (rated insulation voltage (overvoltage category II; degree of pollution 2, safe isolation as per EN 61010-1))

-20°C ... 65°C
 Typically 5% ... 95% (non-condensing)
 V0
 PA 6.6-FR
 17.5 / 99 / 114.5 mm
 0.2 ... 2.5 mm² / 0.2 ... 2.5 mm² / 24 - 14
 0.2 ... 1.5 mm² / 0.2 ... 1.5 mm² / 24 - 16

6 V
 7.4 mA
 11 mW
 CE-compliant
 Ex II (1) G [Ex ia Ga] IIC
 Ex II (1) D [Ex ia Da] IIIC
 Ex II 3 G Ex nA nC ic IIC T4 Gc X
 [Ex ia Ga] IIC, [Ex ia Da] IIIC, Ex nA nC ic IIC T4 Gc X
 2

Ordering data

Type	Order No.	Pcs./Pkt.
MACX MCR-EX-T-UI-UP	2865654	1
MACX MCR-EX-T-UI-UP-SP	2924689	1
MACX MCR-EX-T-UI-UP-C	2811763	1
MACX MCR-EX-T-UI-UP-SP-C	2924692	1

Accessories

IFS-USB-PROG-ADAPTER	2811271	1
----------------------	---------	---

Description	
Temperature transducer, intrinsically safe input	
Standard configuration	Screw connection
Standard configuration	Push-in connection
Order configuration	Screw connection
Order configuration	Push-in connection

Programming adapter for configuring modules with S-PORT interface
--

MACX Analog – Ex i signal conditioners with functional safety

Order key for MACX MCR-EX-T-UI-UP(-SP)-C temperature transducers (standard configuration entered as an example)

Order No.	Safety Integrity Level (SIL)	Sensor type	Connection technology	Cold junction compensation	Measuring range:		Measuring unit	Output range	Factory calibration certificate = FCC
					Start	End			
2811763	ON	PT100	4	0	-50	150	C	OUT02	NONE
2811763 ≙ MACX MCR-EX-T-UI-UP-C	ON ≙ Active NONE ≙ Not active	See below	2 ≙ 2-conductor 3 ≙ 3-conductor 4 ≙ 4-conductor	0 ≙ Off, e.g., with RTD, R, potentiometer, mV 1 ≙ On, e.g., with TC	See below	See below	C ≙ °C F ≙ °F O ≙ Ω P ≙ % V ≙ mV	OUT15 ≙ 0 ... 5 mA OUT16 ≙ 0 ... 10 mA OUT01 ≙ 0 ... 20 mA OUT15 ≙ 0 ... 5 mA OUT25 ≙ 1 ... 5 mA OUT26 ≙ 2 ... 10 mA OUT02 ≙ 4 ... 20 mA OUT05 ≙ 0 ... 5 V OUT03 ≙ 0 ... 10 V OUT06 ≙ 1 ... 5 V OUT04 ≙ 2 ... 10 V OUT13 ≙ -5 ... +5 V OUT14 ≙ -10 ... +10 V Others can be freely configured in the software	NONE ≙ Without FCC YES ≙ With FCC (a fee is charged) YESPLUS ≙ FCC with 5 measuring points (a fee is charged)
2924692 ≙ MACX MCR-EX-T-UI-UP-SP-C	ON only with output range = OUT02							Smallest measuring range span	Other setting options can be configured with the IFS-CONF software:
Resistance temperature detector (RTD)									
		PT50 ≙ Pt 50 IEC60751			-200	850	°C	20k	- Freely configurable user characteristic curve with 30 support points
		PT100 ≙ Pt 100 IEC60751			-200	850	°C	20k	
		PT200 ≙ Pt 200 IEC60751			-200	850	°C	20k	
		PT500 ≙ Pt 500 IEC60751			-200	850	°C	20k	
		PT1000 ≙ Pt 1000 IEC60751			-200	850	°C	20k	
		PT2000 ≙ Pt 2000 IEC60751			-200	850	°C	20k	
		PT5000 ≙ Pt 5000 IEC60751			-200	850	°C	20k	
		PT50S ≙ PT50 SAMA RC21-4-1966			-200	850	°C	20k	
		PT100S ≙ PT100 SAMA RC21-4-1966			-200	850	°C	20k	
		PT200S ≙ PT200 SAMA RC21-4-1966			-200	850	°C	20k	- Filter setting (standard configuration: 1)
		PT500S ≙ PT500 SAMA RC21-4-1966			-200	850	°C	20k	
		PT1000S ≙ PT1000 SAMA RC21-4-1966			-200	850	°C	20k	
		PT2000S ≙ PT2000 SAMA RC21-4-1966			-200	850	°C	20k	- Restart after failsafe (standard configuration: ON)
		PT5000S ≙ PT5000 SAMA RC21-4-1966			-200	850	°C	20k	
		PT100G ≙ PT100 G GOST 6651-2009 (α=0.00391)			-200	850	°C	20k	
		PT200G ≙ PT200 G GOST 6651-2009 (α=0.00391)			-200	850	°C	20k	
		PT500G ≙ PT500 G GOST 6651-2009 (α=0.00391)			-200	850	°C	20k	
		PT1000G ≙ PT1000 G GOST 6651-2009 (α=0.00391)			-200	850	°C	20k	- Switching behavior: switching output (limit values, times, etc.) (standard configuration: OFF)
		PT100J ≙ Pt 100 JIS C1604/1997			-200	850	°C	20k	
		PT200J ≙ Pt 200 JIS C1604/1997			-200	850	°C	20k	
		PT500J ≙ Pt 500 JIS C1604/1997			-200	850	°C	20k	
		PT1000J ≙ Pt 1000 JIS C1604/1997			-200	850	°C	20k	
		NI100 ≙ NI100 DIN 43760			-60	250	°C	20k	
		NI200 ≙ NI200 DIN 43760			-60	250	°C	20k	
		NI500 ≙ NI500 DIN 43760			-60	250	°C	20k	
		NI1000 ≙ NI1000 DIN 43760			-60	250	°C	20k	
		NI100S ≙ NI100 SAMA RC21-4-1966			-60	180	°C	20k	
		NI200S ≙ NI200 SAMA RC21-4-1966			-60	180	°C	20k	
		NI500S ≙ NI500 SAMA RC21-4-1966			-60	180	°C	20k	
		NI1000S ≙ NI1000 SAMA RC21-4-1966			-60	180	°C	20k	
		NI1000L ≙ NI1000 Landis&Gyr			-50	160	°C	20k	
		CU10 ≙ CU10 SAMA RC21-4-1966			-70	500	°C	20k	
		CU50 ≙ CU 50 GOST 6651-2009 (α=0.00428)			-50	200	°C	20k	
		CU100 ≙ CU 100 GOST 6651-2009 (α=0.00428)			-50	200	°C	20k	
		CU53 ≙ CU 53 GOST 6651-2009 (α=0.00426)			-50	180	°C	20k	
		KTY81 ≙ KTY81 KTY81-110 (Philips)			-55	150	°C	20k	
		KTY84 ≙ KTY81 KTY84-130 (Philips)			-40	300	°C	20k	
Thermocouples (TC)		A1G ≙ A-1 GOST 8.585-2001			0	2,500	°C	50k	
		A2G ≙ A-2 GOST 8.585-2001			0	1,800	°C	50k	
		A3G ≙ A-3 GOST 8.585-2001			0	1,800	°C	50k	
		B ≙ B IEC584-1 (Pt30Rh-Pt6Rh)			500	1,820	°C	50k	
		C ≙ C ASTM E988			0	2,315	°C	50k	
		D ≙ DA ASTM E988(2002)			0	2,315	°C	50k	
		E ≙ E IEC584-1 (NiCr-CuNi)			-230	1,000	°C	50k	
		J ≙ J IEC584-1 (Fe-CuNi)			-210	1,200	°C	50k	
		K ≙ K IEC584-1 (NiCr-Ni)			-250	1,372	°C	50k	
		MG ≙ MG GOST 8.585-2001			-200	100	°C	50k	
		N ≙ N IEC 584-1 (NiCrSi-NiSi)			-200	1,300	°C	50k	
		R ≙ R IEC 584-1 (Pt13Rh-Pt)			-50	1,768	°C	50k	
		S ≙ S IEC 584-1 (Pt10Rh-Pt)			-50	1,768	°C	50k	
		T ≙ T IEC 584-1 (Cu-CuNi)			-200	400	°C	50k	
		L ≙ L DIN 43760 (Fe-CuNi)			-200	900	°C	50k	
		LG ≙ LG GOST 8.585-2001			-200	800	°C	50k	
		U ≙ U DIN 43760 (Cu-CuNi)			-200	600	°C	50k	
Remote resistance-type sensors (R) (2-, 3-, 4-conductor)		RES12 ≙ Resistance 0...50,000 Ω For more values, visit www.phoenixcontact.com			0	50,000	Ω	10% of the selected measuring range	
Potentiometers (3-conductor)		POT12 ≙ Potentiometer 0...50,000 Ω For more values, visit www.phoenixcontact.com			0	50,000	Ω	10% of the selected measuring range	
Voltage signals (mV)		V04 ≙ Voltage -1,000 mV...+1,000 mV For more values, visit www.phoenixcontact.com			-1,000	1,000	mV	10% of nominal span	

Temperature conversion guide for °C to °F: $T [°F] = T [°C] + 32$

Temperature

Temperature transducers, Ex i

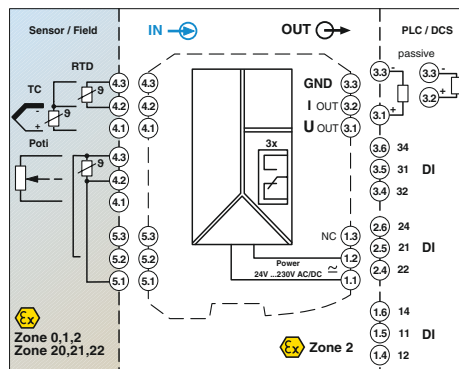
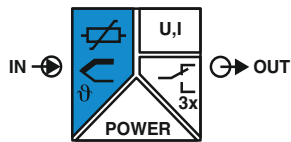

Temperature transducer, universal, with three limit value relays, wide range supply

Functional Safety
Ex: EAC Ex IEC Ex EN Ex
Housing width 35 mm

Universal temperature transducer with freely configurable properties for intrinsically safe operation of resistance thermometers, thermocouples, resistance-type sensors, and potentiometers installed in Ex areas

- Input for resistance thermometers, thermocouples, resistance-type sensors, potentiometers, and mV sources, [Ex ia]
- Measure differential temperatures
- Freely programmable input and output
- Option of inverse output signal ranges
- Three limit value relays, can be used in combination as a safe limit value relay
- Configuration via software (FDT-DTM)
- Programming during operation with Ex measuring circuit connected and also voltage-free using IFS-USB-PROG-ADAPTER programming adapter
- Plug-in screw or Push-in connection technology
- Cold junction compensation with separate connector
- Wide-range power supply of 19.2 to 253 V AC/DC
- Status indicator for supply voltage, cable, sensor, and module errors
- Up to SIL 2 in accordance with IEC 61508
- PL d in accordance with EN ISO 13849-1
- Installation in zone 2 permitted

Notes:
The configuration software can be downloaded from the Internet (phoenixcontact.net/products).
For information on the programming adapter, refer to page 173

Input data	Resistance thermometers Thermocouple sensors
Resistor	Potentiometer
Output data	Output signal
Maximum output signal	Load R_B
Behavior in the event of a sensor error	Switching output
Contact type	Contact material
Max. switching voltage	Maximum switching current
General data	Supply voltage range
Power consumption	Temperature coefficient
Maximum transmission error	Electrical isolation
Ambient temperature range	Humidity
Inflammability class in accordance with UL 94	Housing material
Dimensions W/H/D	Screw connection rigid / flexible / AWG
Push-in connection rigid / flexible / AWG	Safety data as per ATEX
Maximum output voltage U_o	Maximum output current I_o
Maximum output power P_o	Conformance/approvals
Conformance	ATEX
IECEX	SIL in accordance with IEC 61508

Technical data

Pt, Ni, Cu sensors: 2-, 3-, 4-conductor	B, E, J, K, N, R, S, T, L, U, CA, DA, A1G, A2G, A3G, MG, LG
0 Ω ... 50 kΩ	0 Ω ... 50 kΩ
-1,000 mV ... 1,000 mV	U output
4 mA ... 20 mA (in the case of SIL; further free configuration without SIL)	I output
± 11 V	22 mA
≥ 10 kΩ	≤ 600 Ω (20 mA)
In accordance with NE 43 or freely configurable	Relay output
3 PDTs	AgSnO ₂ , hard gold-plated
250 V AC (250 V DC)	2 A (250 V AC) / 2 A (28 V DC)
24 V ... 230 V AC/DC (-20%/+10%, 50/60 Hz)	< 2.4 W
0.01%/K	0.1% (e.g. for Pt 100, 300 K span, 4 ... 20 mA)
2.5 kV (50 Hz, 1 min., test voltage)	Input/output/power supply
375 V (peak value in accordance with EN 60079-11)	Input/output
375 V (peak value in accordance with EN 60079-11)	Input/power supply
375 V (peak value in accordance with EN 60079-11)	Input/switching output
300 V _{rms} (rated insulation voltage (overvoltage category II; degree of pollution 2, safe isolation as per EN 61010-1))	Output/supply
-20°C ... 65°C	
Typically 5% ... 95% (non-condensing)	
V0	
PA 6.6-FR	
35 / 99 / 114.5 mm	
0.2 ... 2.5 mm ² / 0.2 ... 2.5 mm ² / 24 - 14	
0.2 ... 1.5 mm ² / 0.2 ... 1.5 mm ² / 24 - 16	
6 V	
7.4 mA	
11 mW	
CE-compliant	
Ex II (1) G [Ex ia Ga] IIC	
Ex II (1) D [Ex ia Da] IIC	
Ex II 3 G Ex nA nC ic IIC T4 Gc X	
[Ex ia Ga] IIC, [Ex ia Da] IIC, Ex nA nC ic IIC T4 Gc X	
2	

Ordering data

Type	Order No.	Pcs./Pkt.
MACX MCR-EX-T-UIREL-UP	2865751	1
MACX MCR-EX-T-UIREL-UP-SP	2924799	1
MACX MCR-EX-T-UIREL-UP-C	2865722	1
MACX MCR-EX-T-UIREL-UP-SP-C	2924809	1

Accessories

IFS-USB-PROG-ADAPTER	2811271	1
----------------------	---------	---

Description	Temperature transducer, intrinsically safe input
Standard configuration	Screw connection
Standard configuration	Push-in connection
Order configuration	Screw connection
Order configuration	Push-in connection

Programming adapter for configuring modules with S-PORT interface

MACX Analog – Ex i signal conditioners with functional safety

Order key for MACX MCR-EX-TUIREL-UP(-SP)-C temperature transducers (standard configuration entered as an example)

Order No.	SIL	Measuring unit	Sensor type	Connection technology	Measuring range: Start End		Output signal	Switching function 1	Lower switching point 1	Upper switching point 1	Switching function 2	Lower switching point 2	Upper switching point 2	Factory calibration certificate
2865722	ON	C	PT100	4	-50	150	OUT02	0	99999	99999	0	99999	99999	NONE
2865722 ≙ MACX MCR-EX-TUIREL-UP-C	ON ≙ Active NONE ≙ Not active	Celsius [C] Ω [O] Millivolts [V]	See below	2 ≙ 2-conductor 3 ≙ 3-conductor 4 ≙ 4-conductor	See below	See below	0...20 mA [OUT01] 4...20 mA [OUT02] 0...10 V [OUT03] 2...10 V [OUT04] 0...5 V [OUT05] 1...5 V [OUT06] -5...+5 V [OUT13] -10...+10 V [OUT14] 0...5 mA [OUT15] 0...10 mA [OUT16] 1...5 mA [OUT25] 2...10 mA [OUT26]	L [0] H [1] L → SPH → H [2] H → SPH → L [3] L → SPH → H → SPL → L [4] H → SPH → L → SPL → H [5] L → SPL → H → SPH → L [6] H → SPL → L → SPH → H [7]	Free input, see web site for more	Free input, see web site for more		Free input, see web site for more	Free input, see web site for more	NONE ≙ Without FCC YES ≙ With FCC (a fee is charged) YESPLUS ≙ FCC with 5 measuring points (a fee is charged)
2924809 ≙ MACX MCR-EX-TUIREL-UP-SP-C	ON only with output range = OUT02													

Resistance temperature detector (RTD)

°C										Smallest measuring range span
°C	PT50	≙ Pt 50 IEC60751	-200	850	20k					
°C	PT100	≙ Pt 100 IEC60751	-200	850	20k					
°C	PT200	≙ Pt 200 IEC60751	-200	850	20k					
°C	PT500	≙ Pt 500 IEC60751	-200	850	20k					
°C	PT1000	≙ Pt 1000 IEC60751	-200	850	20k					
°C	PT2000	≙ Pt 2000 IEC60751	-200	850	20k					
°C	PT5000	≙ Pt 5000 IEC60751	-200	850	20k					
°C	PT50S	≙ PT50 SAMA RC21-4-1966	-200	850	20k					
°C	PT100S	≙ PT100 SAMA RC21-4-1966	-200	850	20k					
°C	PT200S	≙ PT200 SAMA RC21-4-1966	-200	850	20k					
°C	PT500S	≙ PT500 SAMA RC21-4-1966	-200	850	20k					
°C	PT1000S	≙ PT1000 SAMA RC21-4-1966	-200	850	20k					
°C	PT2000S	≙ PT2000 SAMA RC21-4-1966	-200	850	20k					
°C	PT5000S	≙ PT5000 SAMA RC21-4-1966	-200	850	20k					
°C	PT100G	≙ PT100 G GOST 6651-2009 (α=0,00391)	-200	850	20k					
°C	PT200G	≙ PT200 G GOST 6651-2009 (α=0,00391)	-200	850	20k					
°C	PT500G	≙ PT500 G GOST 6651-2009 (α=0,00391)	-200	850	20k					
°C	PT1000G	≙ PT1000 G GOST 6651-2009 (α=0,00391)	-200	850	20k					
°C	PT100J	≙ Pt 100 JIS C1604/1997	-200	850	20k					
°C	PT200J	≙ Pt 200 JIS C1604/1997	-200	850	20k					
°C	PT500J	≙ Pt 500 JIS C1604/1997	-200	850	20k					
°C	PT1000J	≙ Pt 1000 JIS C1604/1997	-200	850	20k					
°C	NI100	≙ Ni100 DIN 43760	-60	250	20k					
°C	NI200	≙ Ni200 DIN 43760	-60	250	20k					
°C	NI500	≙ Ni500 DIN 43760	-60	250	20k					
°C	NI1000	≙ Ni1000 DIN 43760	-60	250	20k					
°C	NI100S	≙ Ni100 SAMA RC21-4-1966	-60	180	20k					
°C	NI200S	≙ Ni200 SAMA RC21-4-1966	-60	180	20k					
°C	NI500S	≙ Ni500 SAMA RC21-4-1966	-60	180	20k					
°C	NI1000S	≙ Ni1000 SAMA RC21-4-1966	-60	180	20k					
°C	NI1000L	≙ Ni1000 Landis&Gyr	-50	160	20k					
°C	CU10	≙ CU10 SAMA RC21-4-1966	-70	500	20k					
°C	CU50	≙ CU 50 GOST 6651-2009 (α=0,00428)	-50	200	20k					
°C	CU100	≙ CU 100 GOST 6651-2009 (α=0,00428)	-50	200	20k					
°C	CU53	≙ CU 53 GOST 6651-2009 (α=0,00426)	-50	180	20k					
°C	KTY81	≙ KTY81 KTY81-110 (Philips)	-55	150	20k					
°C	KTY84	≙ KTY81 KTY84-130 (Philips)	-40	300	20k					

Other setting options can be configured with the IFS-CONF software:

- Freely configurable user characteristic curve with 30 support points
- Output behavior in the event of a short circuit, sensor break or overrange/underrange can be freely configured or set in accordance with NE43 (standard configuration: NE43 upscale)
- Filter setting (standard configuration: 1)
- Restart after failsafe (standard configuration: ON)
- Switching behavior: switching output (limit values, times, etc.) (standard configuration: OFF)

Thermocouples (TC)

°C	A1G	≙ A-1 GOST 8.585-2001	0	2,500	50k
°C	A2G	≙ A-2 GOST 8.585-2001	0	1,800	50k
°C	A3G	≙ A-3 GOST 8.585-2001	0	1,800	50k
°C	B	≙ B IEC584-1 (Pt30Rh-Pt6Rh)	500	1,820	50k
°C	C	≙ C ASTM E988	0	2,315	50k
°C	D	≙ DA ASTM E988(2002)	0	2,315	50k
°C	E	≙ E IEC584-1 (NiCr-CuNi)	-230	1,000	50k
°C	J	≙ J IEC584-1 (Fe-CuNi)	-210	1,200	50k
°C	K	≙ K IEC584-1 (NiCr-Ni)	-250	1,372	50k
°C	MG	≙ MG GOST 8.585-2001	-200	100	50k
°C	N	≙ N IEC 584-1 (NiCrSi-NiSi)	-200	1,300	50k
°C	R	≙ R IEC 584-1 (Pt13Rh-Pt)	-50	1,768	50k
°C	S	≙ S IEC 584-1 (Pt10Rh-Pt)	-50	1,768	50k
°C	T	≙ T IEC 584-1 (Cu-CuNi)	-200	400	50k
°C	L	≙ L DIN 43760 (Fe-CuNi)	-200	900	50k
°C	LG	≙ LG GOST 8.585-2001	-200	800	50k
°C	U	≙ U DIN 43760 (Cu-CuNi)	-200	600	50k

Remote resistance-type sensors (R) (2-, 3-, 4-conductor)

Ω	RES12	≙ Resistance 0...50,000 Ω For more values, visit www.phoenixcontact.com	0	50,000	10% of the selected measuring range
---	-------	--	---	--------	-------------------------------------

Potentiometers (3-conductor)

Ω	POT12	≙ Potentiometer 0...50,000 Ω For more values, visit www.phoenixcontact.com	0	50,000	10% of the selected measuring range
---	-------	---	---	--------	-------------------------------------

Voltage signals (mV)

mV	V04	≙ Voltage -1,000 mV...+1,000 mV For more values, visit www.phoenixcontact.com	-1,000	1,000	10% of nominal span
----	-----	--	--------	-------	---------------------

Temperature conversion guide for °C to °F:
$$T [°F] = \frac{9}{5} T [°C] + 32$$

Digital IN
NAMUR signal conditioners, Ex i

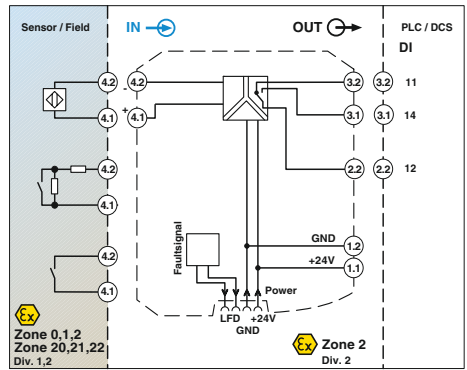
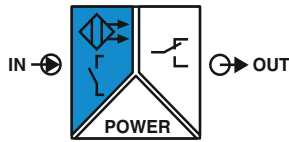

NAMUR signal conditioner, signal output: PDT relay

DNV GL Functional Safety
Ex: EAC Ex IEC Ex KC-s
Housing width 12.5 mm

NAMUR signal conditioners for intrinsically safe operation of proximity sensors and mechanical contacts installed in Ex areas.

- Input for NAMUR proximity sensors (EN 60947-5-6), floating contacts or contacts with resistance circuit, [Ex ia]
- Relay signal output (PDT)
- Reversible direction of action (operating current or closed-circuit current behavior)
- Line fault detection (LFD) can be activated and deactivated, error indicated by red flashing led and de-excitation of the output relay
- Power supply and error indication possible via the DIN rail connector
- LED displays for indicating supply voltage, circuit state, and malfunctions to NAMUR NE 44
- 3-way electrical isolation
- Up to SIL 2 in accordance with IEC 61508
- Installation in zone 2 permitted

Notes:

Information about the supply and error evaluation module as well as about the DIN rail connectors and marking material can be found from page 175

Information about resistance circuits is given on page 177

Information on "Plug and play" connection using system cabling can be found from page 170

Input data	Input signal
	No-load voltage Switching points Switching hysteresis Line error detection
Switching output	Contact type Contact material Max. switching voltage Maximum switching capacity Recommended minimum load Mechanical service life Switching behavior Maximum switching frequency
General data	Supply voltage range Current consumption Power dissipation Number of channels Electrical isolation
	Input/output Input/output/supply, DIN rail connector
	Output/input, supply, TBUS
Ambient temperature range	-20°C ... 60°C (any mounting position)
Humidity	10% ... 95% (non-condensing)
Status indication	Green LED (supply voltage) LED yellow (switching state) Red LED (line errors) V0
Inflammability class in accordance with UL 94	V0
Dimensions W/H/D	12.5 / 99 / 114.5 mm
Screw connection rigid / flexible / AWG	0.2 ... 2.5 mm ² / 0.2 ... 2.5 mm ² / 24 - 14
Push-in connection rigid / flexible / AWG	0.2 ... 1.5 mm ² / 0.2 ... 1.5 mm ² / 24 - 16
Safety data as per ATEX	9.6 V 10 mA 25 mW 253 V AC (125 V DC)
Maximum output voltage U_o	
Maximum output current I_o	
Maximum output power P_o	
Maximum voltage U_m	
Conformance/approvals	CE-compliant, additionally EN 61326 Ex II (1) G [Ex ia Ga] IIC Ex II (1) D [Ex ia Da] IIIC Ex II 3 (1) G Ex nA nC [ia Ga] IIC T4 Gc [Ex ia Ga] IIC, [Ex ia Da] IIIC, Ex nA nC [ia Ga] IIC T4 Gc Class I Div 2; IS for Class I, II, III Div 1 UL 61010 Listed
Conformance	
ATEX	
IECEX	
UL, USA/Canada	
SIL in accordance with IEC 61508	2

Technical data

NAMUR proximity sensors (IEC/EN 60947-5-6)
Floating switch contacts
Switch contacts with resistance circuit
~ 8 V DC
>2.1 mA (conductive) / <1.2 mA (blocking)
<0.2 mA
Break 0.05 mA <IIN <0.35 mA
Short circuit 100 Ω <RSensor <360 Ω
Relay output
1 PDT
AgSnO ₂ , hard gold-plated
250 V AC (2 A) / 120 V DC (0.2 A) / 30 V DC (2 A)
500 VA
5 V / 10 mA
10 ⁷ cycles
Can be inverted via slide switch
≤20 Hz (without load)
19.2 V DC ... 30 V DC (24 V DC -20%...+25%)
21 mA (24 V DC)
<650 mW
1
375 V (peak value in accordance with EN 60079-11)
300 V _{rms} (rated insulation voltage (overvoltage category II; degree of pollution 2, safe isolation as per EN 61010-1))
2.5 kV (50 Hz, 1 min., test voltage)
300 V _{rms} (rated insulation voltage (overvoltage category III; degree of pollution 2, safe isolation as per EN 61010-1))
2.5 kV (50 Hz, 1 min., test voltage)
-20°C ... 60°C (any mounting position)
10% ... 95% (non-condensing)
Green LED (supply voltage)
LED yellow (switching state)
Red LED (line errors)
V0
12.5 / 99 / 114.5 mm
0.2 ... 2.5 mm ² / 0.2 ... 2.5 mm ² / 24 - 14
0.2 ... 1.5 mm ² / 0.2 ... 1.5 mm ² / 24 - 16
9.6 V
10 mA
25 mW
253 V AC (125 V DC)
CE-compliant, additionally EN 61326
Ex II (1) G [Ex ia Ga] IIC
Ex II (1) D [Ex ia Da] IIIC
Ex II 3 (1) G Ex nA nC [ia Ga] IIC T4 Gc
[Ex ia Ga] IIC, [Ex ia Da] IIIC, Ex nA nC [ia Ga] IIC T4 Gc
Class I Div 2; IS for Class I, II, III Div 1
UL 61010 Listed
2

Ordering data

Description	Type	Order No.	Pcs./Pkt.
NAMUR signal conditioner, 1-channel, input intrinsically safe, output: PDT contact			
Screw connection	MACX MCR-EX-SL-NAM-R	2865434	1
Push-in connection	MACX MCR-EX-SL-NAM-R-SP	2924045	1

Digital IN
NAMUR signal conditioners, Ex i

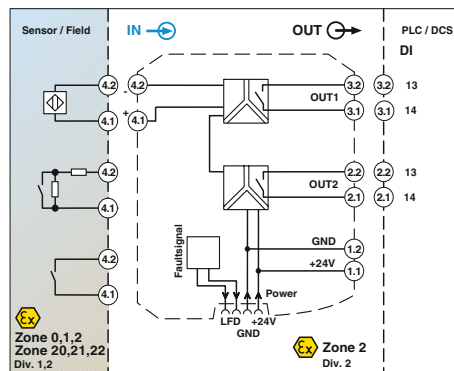
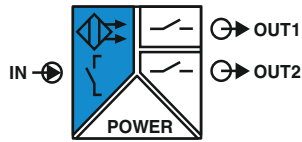

NAMUR signal conditioner:
2 signal outputs: N/O relay

DNV GL Functional Safety
Ex: Ex i Ex ia Ex ib Ex ic Ex nC Ex nD Ex nE Ex nF Ex nG Ex nH Ex nI Ex nJ Ex nK Ex nL Ex nM Ex nN Ex nO Ex nP Ex nQ Ex nR Ex nS Ex nT Ex nU Ex nV Ex nW Ex nX Ex nY Ex nZ Ex nAA Ex nAB Ex nAC Ex nAD Ex nAE Ex nAF Ex nAG Ex nAH Ex nAI Ex nAJ Ex nAK Ex nAL Ex nAM Ex nAN Ex nAO Ex nAP Ex nAQ Ex nAR Ex nAS Ex nAT Ex nAU Ex nAV Ex nAW Ex nAX Ex nAY Ex nAZ Ex nBA Ex nBB Ex nBC Ex nBD Ex nBE Ex nBF Ex nBG Ex nBH Ex nBI Ex nBJ Ex nBK Ex nBL Ex nBM Ex nBN Ex nBO Ex nBP Ex nBQ Ex nBR Ex nBS Ex nBT Ex nBU Ex nBV Ex nBW Ex nBX Ex nBY Ex nBZ Ex nCA Ex nCB Ex nCC Ex nCD Ex nCE Ex nCF Ex nCG Ex nCH Ex nCI Ex nCJ Ex nCK Ex nCL Ex nCM Ex nCN Ex nCO Ex nCP Ex nCQ Ex nCR Ex nCS Ex nCT Ex nCU Ex nCV Ex nCW Ex nCX Ex nCY Ex nCZ Ex nDA Ex nDB Ex nDC Ex nDD Ex nDE Ex nDF Ex nDG Ex nDH Ex nDI Ex nDJ Ex nDK Ex nDL Ex nDM Ex nDN Ex nDO Ex nDP Ex nDQ Ex nDR Ex nDS Ex nDT Ex nDU Ex nDV Ex nDW Ex nDX Ex nDY Ex nDZ Ex nEA Ex nEB Ex nEC Ex nED Ex nEE Ex nEF Ex nEG Ex nEH Ex nEI Ex nEJ Ex nEK Ex nEL Ex nEM Ex nEN Ex nEO Ex nEP Ex nEQ Ex nER Ex nES Ex nET Ex nEU Ex nEV Ex nEW Ex nEX Ex nEY Ex nEZ Ex nFA Ex nFB Ex nFC Ex nFD Ex nFE Ex nFF Ex nFG Ex nFH Ex nFI Ex nFJ Ex nFK Ex nFL Ex nFM Ex nFN Ex nFO Ex nFP Ex nFQ Ex nFR Ex nFS Ex nFT Ex nFU Ex nFV Ex nFW Ex nFX Ex nFY Ex nFZ Ex nGA Ex nGB Ex nGC Ex nGD Ex nGE Ex nGF Ex nGG Ex nGH Ex nGI Ex nGJ Ex nGK Ex nGL Ex nGM Ex nGN Ex nGO Ex nGP Ex nGQ Ex nGR Ex nGS Ex nGT Ex nGU Ex nGV Ex nGW Ex nGX Ex nGY Ex nGZ Ex nHA Ex nHB Ex nHC Ex nHD Ex nHE Ex nHF Ex nHG Ex nHH Ex nHI Ex nHJ Ex nHK Ex nHL Ex nHM Ex nHN Ex nHO Ex nHP Ex nHQ Ex nHR Ex nHS Ex nHT Ex nHU Ex nHV Ex nHW Ex nHX Ex nHY Ex nHZ Ex nIA Ex nIB Ex nIC Ex nID Ex nIE Ex nIF Ex nIG Ex nIH Ex nII Ex nIJ Ex nIK Ex nIL Ex nIM Ex nIN Ex nIO Ex nIP Ex nIQ Ex nIR Ex nIS Ex nIT Ex nIU Ex nIV Ex nIW Ex nIX Ex nIY Ex nIZ Ex nJA Ex nJB Ex nJC Ex nJD Ex nJE Ex nJF Ex nJG Ex nJH Ex nJI Ex nJJ Ex nJK Ex nJL Ex nJM Ex nJN Ex nJO Ex nJP Ex nJQ Ex nJR Ex nJS Ex nJT Ex nJU Ex nJV Ex nJW Ex nJX Ex nJY Ex nJZ Ex nKA Ex nKB Ex nKC Ex nKD Ex nKE Ex nKF Ex nKG Ex nKH Ex nKI Ex nKJ Ex nKL Ex nKM Ex nKN Ex nKO Ex nKP Ex nKQ Ex nKR Ex nKS Ex nKT Ex nKU Ex nKV Ex nKW Ex nKX Ex nKY Ex nKZ Ex nLA Ex nLB Ex nLC Ex nLD Ex nLE Ex nLF Ex nLG Ex nLH Ex nLI Ex nLJ Ex nLK Ex nLL Ex nLM Ex nLN Ex nLO Ex nLP Ex nLQ Ex nLR Ex nLS Ex nLT Ex nLU Ex nLV Ex nLW Ex nLX Ex nLY Ex nLZ Ex nMA Ex nMB Ex nMC Ex nMD Ex nME Ex nMF Ex nMG Ex nMH Ex nMI Ex nMJ Ex nMK Ex nML Ex nMN Ex nMO Ex nMP Ex nMQ Ex nMR Ex nMS Ex nMT Ex nMU Ex nMV Ex nMW Ex nMX Ex nMY Ex nMZ Ex nNA Ex nNB Ex nNC Ex nND Ex nNE Ex nNF Ex nNG Ex nNH Ex nNI Ex nNJ Ex nNK Ex nNL Ex nNM Ex nNN Ex nNO Ex nNP Ex nNQ Ex nNR Ex nNS Ex nNT Ex nNU Ex nNV Ex nNW Ex nNX Ex nNY Ex nNZ Ex nOA Ex nOB Ex nOC Ex nOD Ex nOE Ex nOF Ex nOG Ex nOH Ex nOI Ex nOJ Ex nOK Ex nOL Ex nOM Ex nON Ex nOO Ex nOP Ex nOQ Ex nOR Ex nOS Ex nOT Ex nOU Ex nOV Ex nOW Ex nOX Ex nOY Ex nOZ Ex nPA Ex nPB Ex nPC Ex nPD Ex nPE Ex nPF Ex nPG Ex nPH Ex nPI Ex nPJ Ex nPK Ex nPL Ex nPM Ex nPN Ex nPO Ex nPP Ex nPQ Ex nPR Ex nPS Ex nPT Ex nPU Ex nPV Ex nPW Ex nPX Ex nPY Ex nPZ Ex nQA Ex nQB Ex nQC Ex nQD Ex nQE Ex nQF Ex nQG Ex nQH Ex nQI Ex nQJ Ex nQK Ex nQL Ex nQM Ex nQN Ex nQO Ex nQP Ex nQQ Ex nQR Ex nQS Ex nQT Ex nQU Ex nQV Ex nQW Ex nQX Ex nQY Ex nQZ Ex nRA Ex nRB Ex nRC Ex nRD Ex nRE Ex nRF Ex nRG Ex nRH Ex nRI Ex nRJ Ex nRK Ex nRL Ex nRM Ex nRN Ex nRO Ex nRP Ex nRQ Ex nRR Ex nRS Ex nRT Ex nRU Ex nRV Ex nRW Ex nRX Ex nRY Ex nRZ Ex nSA Ex nSB Ex nSC Ex nSD Ex nSE Ex nSF Ex nSG Ex nSH Ex nSI Ex nSJ Ex nSK Ex nSL Ex nSM Ex nSN Ex nSO Ex nSP Ex nSQ Ex nSR Ex nSS Ex nST Ex nSU Ex nSV Ex nSW Ex nSX Ex nSY Ex nSZ Ex nTA Ex nTB Ex nTC Ex nTD Ex nTE Ex nTF Ex nTG Ex nTH Ex nTI Ex nTJ Ex nTK Ex nTL Ex nTM Ex nTN Ex nTO Ex nTP Ex nTQ Ex nTR Ex nTS Ex nTT Ex nTU Ex nTV Ex nTW Ex nTX Ex nTY Ex nTZ Ex nUA Ex nUB Ex nUC Ex nUD Ex nUE Ex nUF Ex nUG Ex nUH Ex nUI Ex nUJ Ex nUK Ex nUL Ex nUM Ex nUN Ex nUO Ex nUP Ex nUQ Ex nUR Ex nUS Ex nUT Ex nUU Ex nUV Ex nUW Ex nUX Ex nUY Ex nUZ Ex nVA Ex nVB Ex nVC Ex nVD Ex nVE Ex nVF Ex nVG Ex nVH Ex nVI Ex nVJ Ex nVK Ex nVL Ex nVM Ex nVN Ex nVO Ex nVP Ex nVQ Ex nVR Ex nVS Ex nVT Ex nVU Ex nVV Ex nVW Ex nVX Ex nVY Ex nVZ Ex nWA Ex nWB Ex nWC Ex nWD Ex nWE Ex nWF Ex nWG Ex nWH Ex nWI Ex nWJ Ex nWK Ex nWL Ex nWM Ex nWN Ex nWO Ex nWP Ex nWQ Ex nWR Ex nWS Ex nWT Ex nWU Ex nWV Ex nWW Ex nWX Ex nWY Ex nWZ Ex nXA Ex nXB Ex nXC Ex nXD Ex nXE Ex nXF Ex nXG Ex nXH Ex nXI Ex nXJ Ex nXK Ex nXL Ex nXM Ex nXN Ex nXO Ex nXP Ex nXQ Ex nXR Ex nXS Ex nXT Ex nXU Ex nXV Ex nXW Ex nXX Ex nXY Ex nXZ Ex nYA Ex nYB Ex nYC Ex nYD Ex nYE Ex nYF Ex nYG Ex nYH Ex nYI Ex nYJ Ex nYK Ex nYL Ex nYM Ex nYN Ex nYO Ex nYP Ex nYQ Ex nYR Ex nYS Ex nYT Ex nYU Ex nYV Ex nYW Ex nYX Ex nYY Ex nYZ Ex nZA Ex nZB Ex nZC Ex nZD Ex nZE Ex nZF Ex nZG Ex nZH Ex nZI Ex nZJ Ex nZK Ex nZL Ex nZM Ex nZN Ex nZO Ex nZP Ex nZQ Ex nZR Ex nZS Ex nZT Ex nZU Ex nZV Ex nZW Ex nZX Ex nZY Ex nZZ

NAMUR signal conditioners for intrinsically safe operation of proximity sensors and mechanical contacts installed in Ex areas.

- Input for NAMUR proximity sensors (EN 60947-5-6), floating contacts or contacts with resistance circuit, [Ex ia]
- 2 relay signal outputs (N/O contact), output 2 can also be used as an error signal output
- Reversible direction of action (operating current or closed-circuit current behavior)
- Line fault detection (LFD) can be activated and deactivated, error indicated by red flashing led and de-excitation of the output relay
- Power supply and error indication possible via the DIN rail connector
- LED displays for indicating supply voltage, circuit state, and malfunctions to NAMUR NE 44
- 4-way electrical isolation
- Up to SIL 2 in accordance with IEC 61508
- Installation in zone 2 permitted

Notes:
Information about the supply and error evaluation module as well as about the DIN rail connectors and marking material can be found from page 175
Information about resistance circuits is given on page 177
Information on "Plug and play" connection using system cabling can be found from page 170

Input data	
Input signal	
No-load voltage	
Switching points	
Switching hysteresis	
Line error detection	
Switching output	
Contact type	
Contact material	
Max. switching voltage	
Maximum switching capacity	
Recommended minimum load	
Mechanical service life	
Switching behavior	
Maximum switching frequency	
General data	
Supply voltage range	
Current consumption	
Power dissipation	
Electrical isolation	
	Input/output Input/supply, DIN rail connector
	Output 1/output 2/input, power supply, DIN rail connector
	Output 1/output 2/input/power supply, DIN rail connector
Ambient temperature range	
Humidity	
Status indication	
Inflammability class in accordance with UL 94	
Dimensions W/H/D	
Screw connection rigid / flexible / AWG	
Push-in connection rigid / flexible / AWG	
Safety data as per ATEX	
Maximum output voltage U _o	
Maximum output current I _o	
Maximum output power P _o	
Maximum voltage U _m	
Conformance/approvals	
Conformance	
ATEX	
IECEX	
UL, USA/Canada	
SIL in accordance with IEC 61508	

Technical data

NAMUR proximity sensors (EN 60947-5-6)
Floating switch contacts
Switch contacts with resistance circuit
~ 8 V DC
>2.1 mA (conductive) / <1.2 mA (blocking)
<0.2 mA
Break 0.05 mA <I _{IN} <0.35 mA
Short circuit 100 Ω <R _{Sensor} <360 Ω
Relay output
2 N/O contacts
AgSnO ₂ , hard gold-plated
250 V AC (2 A) / 120 V DC (0.2 A) / 30 V DC (2 A)
500 VA
5 V / 10 mA
10 ⁷ cycles
Can be inverted via slide switch
≤20 Hz (without load)
19.2 V DC ... 30 V DC (24 V DC -20%...+25%)
30 mA (24 V DC)
<950 mW
375 V (peak value in accordance with EN 60079-11)
375 V (peak value in accordance with EN 60079-11)
300 V _{rms} (rated insulation voltage (overvoltage category II; degree of pollution 2, safe isolation as per EN 61010-1))
300 V _{rms} (rated insulation voltage (overvoltage category III; degree of pollution 2, safe isolation as per EN 61010-1))
2.5 kV (50 Hz, 1 min., test voltage)
-20°C ... 60°C (any mounting position)
10% ... 95% (non-condensing)
Green LED (supply voltage)
LED yellow (switching state)
Red LED (line errors)
V0
12.5 / 99 / 114.5 mm
0.2 ... 2.5 mm ² / 0.2 ... 2.5 mm ² / 24 - 14
0.2 ... 1.5 mm ² / 0.2 ... 1.5 mm ² / 24 - 16
9.6 V
10 mA
25 mW
253 V AC (125 V DC)
CE-compliant, additionally EN 61326
Ex II (1) G [Ex ia Ga] IIC
Ex II (1) D [Ex ia Da] IIC
Ex II 3 (1) G Ex nA nC [ia Ga] IIC T4 Gc
[Ex ia Ga] IIC, [Ex ia Da] IIC, Ex nA nC [ia Ga] IIC T4 Gc
Class I Div 2; IS for Class I, II, III Div 1
UL 61010 Listed
2

Ordering data

Description	Type	Order No.	Pcs./Pkt.
NAMUR signal conditioner, 1-channel, input intrinsically safe, output: 2 N/O contacts	Screw connection	MACX MCR-EX-SL-NAM-2RO	2865450 1
	Push-in connection	MACX MCR-EX-SL-NAM-2RO-SP	2924061 1

Digital IN
NAMUR signal conditioners, Ex i

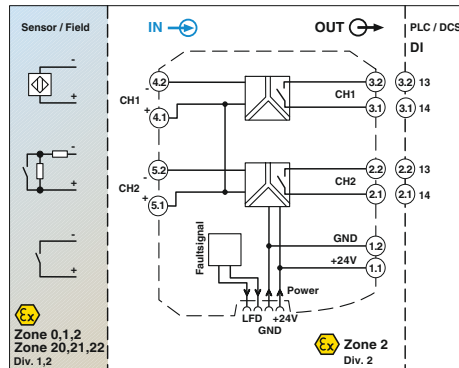
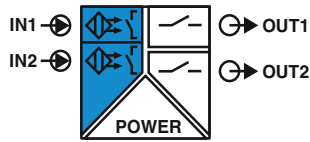

NAMUR signal conditioner, 2-channel, signal output: N/O relay

DNV GL Functional Safety
Ex: EAC Ex IEC Ex KC-s
Housing width 12.5 mm

NAMUR signal conditioners for intrinsically safe operation of proximity sensors and mechanical contacts installed in Ex areas.

- 2-channel
- Input for NAMUR proximity sensors (EN 60947-5-6), floating contacts or contacts with resistance circuit, [Ex ia]
- Relay signal output (N/O contact)
- Reversible direction of action (operating current or closed-circuit current behavior)
- Line fault detection (LFD) can be activated and deactivated, error indicated by red flashing led and de-excitation of the output relay
- Power supply and error indication possible via the DIN rail connector
- LED displays for indicating supply voltage, circuit state, and malfunctions to NAMUR NE 44
- 3-way electrical isolation
- Up to SIL 2 in accordance with IEC 61508
- Installation in zone 2 permitted

Notes:
Information about the supply and error evaluation module as well as about the DIN rail connectors and marking material can be found from page 175
Information about resistance circuits is given on page 177
Information on "Plug and play" connection using system cabling can be found from page 170

Input data	
Input signal	
No-load voltage	
Switching points	
Switching hysteresis	
Line error detection	
Switching output	
Contact type	
Contact material	
Max. switching voltage	
Maximum switching capacity	
Recommended minimum load	
Mechanical service life	
Switching behavior	
Maximum switching frequency	
General data	
Supply voltage range	
Current consumption	
Power dissipation	
Electrical isolation	
Input/output	375 V (peak value in accordance with EN 60079-11)
Input/supply, DIN rail connector	375 V (peak value in accordance with EN 60079-11) 300 V _{rms} (rated insulation voltage (overvoltage category II; degree of pollution 2, safe isolation as per EN 61010-1))
Output 1/output 2/input, power supply, DIN rail connector	300 V _{rms} (rated insulation voltage (overvoltage category III; degree of pollution 2, safe isolation as per EN 61010-1))
Output 1/output 2/input/power supply, DIN rail connector	2.5 kV (50 Hz, 1 min., test voltage)
Ambient temperature range	-20°C ... 60°C (any mounting position)
Humidity	5% ... 95% (non-condensing)
Status indication	Green LED (supply voltage) LED yellow (switching state) Red LED (line errors) V0
Inflammability class in accordance with UL 94	12.5 / 99 / 114.5 mm
Dimensions W/H/D	0.2 ... 2.5 mm ² / 0.2 ... 2.5 mm ² / 24 - 14
Screw connection rigid / flexible / AWG	0.2 ... 1.5 mm ² / 0.2 ... 1.5 mm ² / 24 - 16
Push-in connection rigid / flexible / AWG	
Safety data as per ATEX	
Maximum output voltage U _o	9.6 V
Maximum output current I _o	10 mA
Maximum output power P _o	25 mW
Maximum voltage U _m	253 V AC (125 V DC)
Conformance/approvals	
Conformance	CE-compliant, additionally EN 61326
ATEX	[Ex] II (1) G [Ex ia Ga] IIC [Ex] II (1) D [Ex ia Da] IIIC [Ex] II 3 (1) G Ex nA nC [ia Ga] IIC T4 Gc [Ex ia Ga] IIC, [Ex ia Da] IIIC, Ex nA nC [ia Ga] IIC T4 Gc Class I Div 2; IS for Class I, II, III Div 1 UL 61010 Listed
IECEX	
UL, USA/Canada	
SIL in accordance with IEC 61508	2

Technical data

NAMUR proximity sensors (IEC/EN 60947-5-6)
Floating switch contacts
Switch contacts with resistance circuit
~ 8 V DC
>2.1 mA (conductive) / <1.2 mA (blocking)
<0.2 mA
Break 0.05 mA <IIN <0.35 mA
Short circuit 100 Ω <RSensor <360 Ω
Relay output
1 N/O contact per channel
AgSnO₂, hard gold-plated
250 V AC (2 A) / 120 V DC (0.2 A) / 30 V DC (2 A)
500 VA
5 V / 10 mA
10⁷ cycles
Can be inverted via slide switch
≤20 Hz (without load)

19.2 V DC ... 30 V DC (24 V DC -20%...+25%)
35 mA (24 V DC)
<1 W
375 V (peak value in accordance with EN 60079-11)
375 V (peak value in accordance with EN 60079-11)
300 V_{rms} (rated insulation voltage (overvoltage category II; degree of pollution 2, safe isolation as per EN 61010-1))
300 V_{rms} (rated insulation voltage (overvoltage category III; degree of pollution 2, safe isolation as per EN 61010-1))
2.5 kV (50 Hz, 1 min., test voltage)

-20°C ... 60°C (any mounting position)
5% ... 95% (non-condensing)
Green LED (supply voltage)
LED yellow (switching state)
Red LED (line errors)
V0

12.5 / 99 / 114.5 mm
0.2 ... 2.5 mm² / 0.2 ... 2.5 mm² / 24 - 14
0.2 ... 1.5 mm² / 0.2 ... 1.5 mm² / 24 - 16

9.6 V
10 mA
25 mW
253 V AC (125 V DC)

CE-compliant, additionally EN 61326
[Ex] II (1) G [Ex ia Ga] IIC
[Ex] II (1) D [Ex ia Da] IIIC
[Ex] II 3 (1) G Ex nA nC [ia Ga] IIC T4 Gc
[Ex ia Ga] IIC, [Ex ia Da] IIIC, Ex nA nC [ia Ga] IIC T4 Gc
Class I Div 2; IS for Class I, II, III Div 1
UL 61010 Listed

2

Ordering data

Description
NAMUR signal conditioner, 2-channel, input intrinsically safe, output: N/O contact
Screw connection
Push-in connection

Type	Order No.	Pcs./Pkt.
MACX MCR-EX-SL-2NAM-RO	2865476	1
MACX MCR-EX-SL-2NAM-RO-SP	2924087	1

Digital IN
NAMUR signal conditioners, Ex i

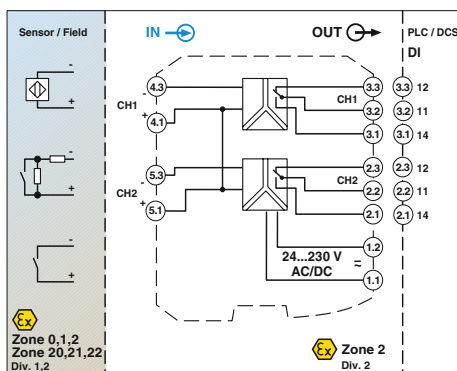
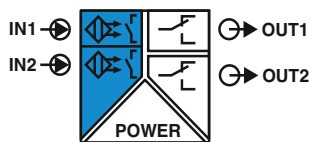

NAMUR signal conditioner, 2-channel, signal output: PDT relay, wide range supply

Functional Safety

Ex: Ex EAC Ex IEC Ex

Housing width 17.5 mm

Technical data

NAMUR signal conditioners for intrinsically safe operation of proximity sensors and mechanical contacts installed in Ex areas.

- 2-channel
- Input for NAMUR proximity sensors (EN 60947-5-6), floating contacts or contacts with resistance circuit, [Ex ia]
- Relay signal output (PDT)
- Reversible direction of action (operating current or closed-circuit current behavior)
- Line fault detection (LFD) can be activated and deactivated, error indicated by red flashing led and de-excitation of the output relay
- Wide-range power supply of 19.2 to 253 V AC/DC
- LED displays for indicating supply voltage, circuit state, and malfunctions to NAMUR NE 44
- 3-way electrical isolation
- Up to SIL 2 in accordance with IEC 61508
- Installation in zone 2 permitted

Input data

Input signal

No-load voltage
Switching points
Switching hysteresis
Line error detection

Switching output

Contact type
Contact material
Max. switching voltage
Maximum switching capacity
Recommended minimum load
Mechanical service life
Switching behavior
Maximum switching frequency

General data

Supply voltage range

Current consumption
Power dissipation
Electrical isolation

Input/output
Input/power supply

Output 1/output 2/input, power supply

Ambient temperature range
Humidity
Inflammability class in accordance with UL 94
Housing material
Dimensions W/H/D
Screw connection rigid / flexible / AWG
Push-in connection rigid / flexible / AWG

Safety data as per ATEX

Maximum output voltage U_o
Maximum output current I_o
Maximum output power P_o
Maximum voltage U_m

Conformance/approvals

Conformance
ATEX

IECEX
UL, USA/Canada
SIL in accordance with IEC 61508

NAMUR proximity sensors (EN 60947-5-6)

Open circuit switch contacts
Switch contacts with resistance circuit
~ 8 V DC

>2.1 mA (conductive) / <1.2 mA (blocking)
<0.2 mA

Break 0.05 mA <I_{IN} <0.35 mA

Short circuit 100 Ω <R_{Sensor} <360 Ω

Relay output

1 PDT per channel
AgSnO₂, hard gold-plated
250 V AC (2 A, 60 Hz) / 120 V DC (0.2 A) / 30 V DC (2 A)
500 VA
5 V / 10 mA
10⁷ cycles
Can be inverted using DIP switch
≤20 Hz (load-dependent)

24 V ... 230 V AC/DC (-20% ... +10%, 50 Hz ... 60 Hz)

<80 mA ; <42 mA (24 V DC)
≤1.3 W

375 V (peak value in accordance with EN 60079-11)
375 V (peak value in accordance with EN 60079-11)
300 V_{rms} (rated insulation voltage (overvoltage category II; degree of pollution 2, safe isolation as per EN 61010-1))
2.5 kV AC (50 Hz, 1 min., test voltage)

300 V_{rms} (rated insulation voltage (overvoltage category III; degree of pollution 2, safe isolation as per EN 61010-1))
2.5 kV (50 Hz, 1 min., test voltage)

-20°C ... 60°C
10% ... 95% (non-condensing)
V0

PA 6.6-FR
17.5 / 99 / 114.5 mm
0.2 ... 2.5 mm² / 0.2 ... 2.5 mm² / 24 - 14
0.2 ... 1.5 mm² / 0.2 ... 1.5 mm² / 24 - 16

9.56 V
10.3 mA
25 mW
253 V AC/DC (supply terminals)
250 V AC (output terminals)
120 V DC (output terminals)

CE-compliant, additionally EN 61326
Ex II (1) G [Ex ia Ga] IIC
Ex II (1) D [Ex ia Da] IIC
Ex II 3(1) G Ex nA nC [ia Ga] IIC T4 Gc X
[Ex ia Ga] IIC, [Ex ia Da] IIC, Ex nA nC [ia Ga] IIC T4 Gc
Class I Div 2; IS for Class I, II, III Div 1
2

Ordering data

Description

NAMUR signal conditioner, 2-channel, input intrinsically safe, output: Changeover contact

Screw connection

Push-in connection

Type	Order No.	Pcs./Pkt.
MACX MCR-EX-SL-2NAM-R-UP	2865984	1
MACX MCR-EX-SL-2NAM-R-UP-SP	2924249	1

Notes:

Information on resistance circuits and marking material can be found on page 177

Digital IN
NAMUR signal conditioners, Ex i

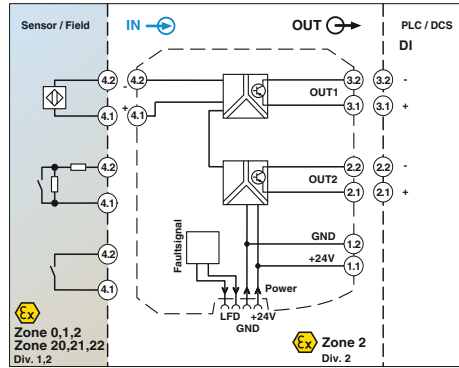
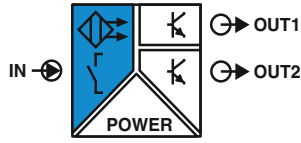

NAMUR signal conditioner:
2 signal outputs: transistor (passive)

DNV GL Functional Safety
Ex: EAC Ex IEC Ex Ex Ex Ex
Housing width 12.5 mm

NAMUR signal conditioners for intrinsically safe operation of proximity sensors and mechanical contacts installed in Ex areas.

- Input for NAMUR proximity sensors (EN 60947-5-6), floating contacts or contacts with resistance circuit, [Ex ia]
- 2 signal outputs transistor (passive), up to 5 kHz
- Signal output 2 can also be used as a fault signaling output
- Reversible direction of action (operating current or closed-circuit current behavior)
- Line fault detection (LFD) can be activated and deactivated, error indicated by red flashing LED and blocking the transistor output
- Power supply and error indication possible via the DIN rail connector
- LED displays for indicating supply voltage, circuit state, and malfunctions to NAMUR NE 44
- 4-way electrical isolation
- Up to SIL 2 in accordance with IEC 61508
- Installation in zone 2 permitted

Notes:

Information about the supply and error evaluation module as well as about the DIN rail connectors and marking material can be found from page 175
Information about resistance circuits is given on page 177
Information on "Plug and play" connection using system cabling can be found from page 170

Input data	
Input signal	
No-load voltage	
Switching points	
Line error detection	
Switching output	
Max. switching voltage	
Maximum switching current	
Drop (ΔU)	
Switching behavior	
Maximum switching frequency	
General data	
Supply voltage range	
Current consumption	
Power dissipation	
Number of channels	
Electrical isolation	
Input/output	375 V (peak value in accordance with EN 60079-11)
Input/output/supply, DIN rail connector	300 V _{rms} (rated insulation voltage (overvoltage category II; degree of pollution 2, safe isolation as per EN 61010-1)) 2.5 kV (50 Hz, 1 min., test voltage)
Input/supply, DIN rail connector	375 V (peak value in accordance with EN 60079-11)
Output 1/output 2	50 V _{rms} (rated insulation voltage (overvoltage category II; degree of pollution 2, basic insulation as per EN 61010-1)) 1 kV (50 Hz, 1 min., test voltage)
Ambient temperature range	-20°C ... 60°C (any mounting position)
Humidity	10% ... 95% (non-condensing)
Status indication	Green LED (supply voltage) LED yellow (switching state) Red LED (line errors)
Inflammability class in accordance with UL 94	V0
Housing material	PA 6.6-FR
Dimensions W/H/D	12.5 / 99 / 114.5 mm
Screw connection rigid / flexible / AWG	0.2 ... 2.5 mm ² / 0.2 ... 2.5 mm ² / 24 - 14
Push-in connection rigid / flexible / AWG	0.2 ... 1.5 mm ² / 0.2 ... 1.5 mm ² / 24 - 16
Safety data as per ATEX	
Maximum output voltage U _o	
Maximum output current I _o	
Maximum output power P _o	
Maximum voltage U _m	
Conformance/approvals	
Conformance	
ATEX	
IECEX	
UL, USA/Canada	
SIL in accordance with IEC 61508	

Technical data

NAMUR proximity sensors (EN 60947-5-6)
Floating switch contacts
Switch contacts with resistance circuit
~ 8 V DC
>2.1 mA (conductive) / <1.2 mA (blocking)
Break 0.05 mA <I_{IN} <0.35 mA
Short circuit 100 Ω <R_{Sensor} <360 Ω
2 transistor outputs, passive
30 V DC
50 mA (short-circuit-proof)
<1.4 V
Can be inverted using DIP switch
≤5 kHz

19.2 V DC ... 30 V DC (24 V DC -20%...+25%)
<28 mA (24 V DC)
≤800 mW
1

375 V (peak value in accordance with EN 60079-11)
300 V_{rms} (rated insulation voltage (overvoltage category II; degree of pollution 2, safe isolation as per EN 61010-1))
2.5 kV (50 Hz, 1 min., test voltage)

375 V (peak value in accordance with EN 60079-11)
50 V_{rms} (rated insulation voltage (overvoltage category II; degree of pollution 2, basic insulation as per EN 61010-1))
1 kV (50 Hz, 1 min., test voltage)

-20°C ... 60°C (any mounting position)
10% ... 95% (non-condensing)
Green LED (supply voltage)
LED yellow (switching state)
Red LED (line errors)

V0
PA 6.6-FR
12.5 / 99 / 114.5 mm
0.2 ... 2.5 mm² / 0.2 ... 2.5 mm² / 24 - 14
0.2 ... 1.5 mm² / 0.2 ... 1.5 mm² / 24 - 16

9.6 V
10 mA
25 mW
253 V AC (125 V DC)

CE-compliant, additionally EN 61326
Ex II (1) G [Ex ia Ga] IIC
Ex II (1) D [Ex ia Da] IIIC
Ex II 3 (1) G Ex nA [ia Ga] IIC T4 Gc
[Ex ia Ga] IIC, [Ex ia Da] IIIC, Ex nA [ia Ga] IIC T4 Gc
Class I Div 2; IS for Class I, II, III Div 1
2

Ordering data

Description	Type	Order No.	Pcs./Pkt.
NAMUR signal conditioner , input intrinsically safe, output: Transistor, passive	Screw connection	MACX MCR-EX-SL-NAM-2T 2865463	1
	Push-in connection	MACX MCR-EX-SL-NAM-2T-SP 2924074	1

Digital IN
NAMUR signal conditioners, Ex i

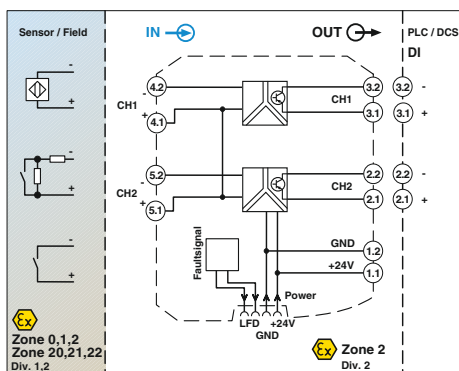
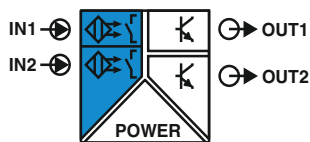

NAMUR signal conditioner, 2-channel,
signal output: transistor (passive)

DNV GL Functional Safety

Ex: Ex EAC Ex IEC Ex SIL

Housing width 12.5 mm

NAMUR signal conditioners for intrinsically safe operation of proximity sensors and mechanical contacts installed in Ex areas.

- 2-channel
- Input for NAMUR proximity sensors (EN 60947-5-6), floating contacts or contacts with resistance circuit, [Ex ia]
- Signal output transistor (passive), up to 5 kHz
- Reversible direction of action (operating current or closed-circuit current behavior)
- Line fault detection (LFD) can be activated and deactivated, error indicated by red flashing LED and blocking the transistor output
- Power supply and error indication possible via the DIN rail connector
- LED displays for indicating supply voltage, circuit state, and malfunctions to NAMUR NE 44
- 3-way electrical isolation
- Up to SIL 2 in accordance with IEC 61508
- Installation in zone 2 permitted

Notes:
Information about the supply and error evaluation module as well as about the DIN rail connectors and marking material can be found from page 175
Information about resistance circuits is given on page 177
Information on "Plug and play" connection using system cabling can be found from page 170

Input data	
Input signal	
No-load voltage	
Switching points	
Line error detection	
Switching output	
Max. switching voltage	
Maximum switching current	
Drop (ΔU)	
Switching behavior	
Maximum switching frequency	
General data	
Supply voltage range	
Current consumption	
Power dissipation	
Number of channels	
Electrical isolation	
Ambient temperature range	
Humidity	
Status indication	
Inflammability class in accordance with UL 94	
Housing material	
Dimensions W/H/D	
Screw connection rigid / flexible / AWG	
Push-in connection rigid / flexible / AWG	
Safety data as per ATEX	
Maximum output voltage U _o	
Maximum output current I _o	
Maximum output power P _o	
Maximum voltage U _m	
Conformance/approvals	
Conformance	
ATEX	
IECEX	
UL, USA/Canada	
SIL in accordance with IEC 61508	

Technical data

NAMUR proximity sensors (EN 60947-5-6)	
Floating switch contacts	
Switch contacts with resistance circuit	
~ 8 V DC	
>2.1 mA (conductive) / <1.2 mA (blocking)	
Break 0.05 mA <I _{IN} <0.35 mA	
Short circuit 100 Ω <R _{Sensor} <360 Ω	
1 transistor output, passive (per channel)	
30 V DC	
50 mA (short-circuit-proof)	
<1.4 V	
Can be inverted using DIP switch	
≤5 kHz	
General data	
Supply voltage range	19.2 V DC ... 30 V DC (24 V DC -20%...+25%)
Current consumption	<34 mA (24 V DC)
Power dissipation	≤1,000 mW
Number of channels	2
Electrical isolation	
Input/output	375 V (peak value in accordance with EN 60079-11)
Input/output/supply, DIN rail connector	300 V _{rms} (rated insulation voltage (overvoltage category II; degree of pollution 2, safe isolation as per EN 61010-1)) 2.5 kV (50 Hz, 1 min., test voltage)
Input/supply, DIN rail connector	375 V (peak value in accordance with EN 60079-11)
Output 1/output 2	50 V _{rms} (rated insulation voltage (overvoltage category II; degree of pollution 2, basic insulation as per EN 61010-1)) 1 kV (50 Hz, 1 min., test voltage)
Ambient temperature range	-20°C ... 60°C (any mounting position)
Humidity	10% ... 95% (non-condensing)
Status indication	Green LED (supply voltage) LED yellow (switching state) Red LED (line errors)
Inflammability class in accordance with UL 94	V0
Housing material	PA 6.6-FR
Dimensions W/H/D	12.5 / 99 / 114.5 mm
Screw connection rigid / flexible / AWG	0.2 ... 2.5 mm ² / 0.2 ... 2.5 mm ² / 24 - 14
Push-in connection rigid / flexible / AWG	0.2 ... 1.5 mm ² / 0.2 ... 1.5 mm ² / 24 - 16
Safety data as per ATEX	
Maximum output voltage U _o	9.6 V
Maximum output current I _o	10 mA
Maximum output power P _o	25 mW
Maximum voltage U _m	253 V AC (125 V DC)
Conformance/approvals	
Conformance	CE-compliant, additionally EN 61326
ATEX	Ex II (1) G [Ex ia Ga] IIC Ex II (1) D [Ex ia Da] IIIC Ex II 3 (1) G Ex nA [ia Ga] IIC T4 Gc [Ex ia Ga] IIC, [Ex ia Da] IIIC, Ex nA [ia Ga] IIC T4 Gc Class I Div 2; IS for Class I, II, III Div 1
IECEX	
UL, USA/Canada	
SIL in accordance with IEC 61508	2

Ordering data

Description	Type	Order No.	Pcs./Pkt.
NAMUR signal conditioner, 2-channel, input intrinsically safe, output: Transistor, passive			
Screw connection	MACX MCR-EX-SL-2NAM-T	2865489	1
Push-in connection	MACX MCR-EX-SL-2NAM-T-SP	2924090	1

Digital IN
NAMUR signal conditioners, Ex i

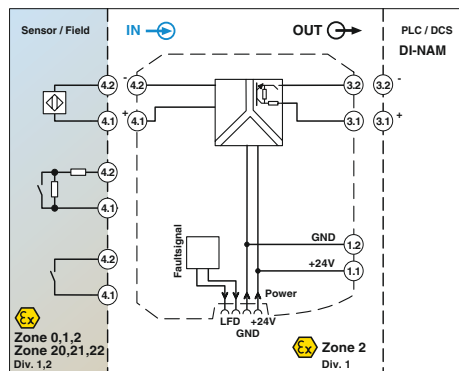
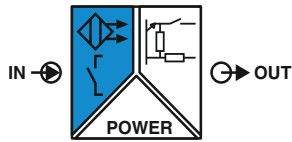

NAMUR signal conditioner, with line fault transparency

Functional Safety
Ex: EAC Ex IEC SIL
Housing width 12.5 mm

NAMUR signal conditioners for the intrinsically safe operation of proximity sensors or mechanical contacts installed in the Ex area.

- Input for NAMUR proximity sensors (EN 60947-5-6), floating contacts or contacts with resistance circuit, [Ex ia]
- Signal output with resistive behavior (transistor)
- Signal output with line fault transparency: line error message directly via output to PLC or PCS. The output responds in accordance with EN 60947-5-6
- Up to 5 kHz
- Direction of operation can be selected
- Line fault detection can be activated and deactivated
- Power supply and error indication possible via the DIN rail connector
- LED indicators for supply voltage, status, and fault in accordance with NAMUR NE 44
- Plug-in screw or Push-in connection technology
- Safe 3-way electrical isolation
- Up to SIL 2 in accordance with IEC 61508
- Installation in zone 2 permitted

Notes:
Information on the supply and error evaluation module, DIN rail connectors, system cabling, and marking material can be found from page 175
Information about resistance circuits is given on page 177

Input data	
Input signal	
No-load voltage	
Switching points	
Line error detection	
Switching output	
Switching voltage	
Switching frequency	
Impedance 0-signal	
Impedance 1-signal	
Impedance fault	
Switching behavior	
General data	
Supply voltage range	
Current draw	
Power dissipation	
Electrical isolation	
Ambient temperature range	
Humidity	
Status indication	
Inflammability class in accordance with UL 94	
Housing material	
Dimensions W/H/D	
Screw connection rigid / flexible / AWG	
Push-in connection rigid / flexible / AWG	
Safety data as per ATEX	
Maximum output voltage U _o	
Maximum output current I _o	
Maximum output power P _o	
Maximum voltage U _m	
Conformance/approvals	
Conformance	
ATEX	
IECEX	
SIL in accordance with IEC 61508	

Technical data		
NAMUR proximity sensors (EN 60947-5-6)		
Open circuit switch contacts		
Switch contacts with resistance circuit		
8 V DC ±10%		
>2.1 mA (conductive) / <1.2 mA (blocking)		
Break 0.05 mA <I _{IN} <0.35 mA		
Short circuit 100 Ω <R _{Sensor} <360 Ω		
Resistive (transistor, passive)		
8.2 V DC ±10% (in accordance with EN 60947-5-6)		
≤5 kHz (ohmic load)		
11 kΩ ±5%		
1.4 kΩ ±5%		
>100 kΩ		
Can be inverted using DIP switch		
9.6 V DC ... 30 V DC (12 V DC ... 24 V DC (-20% ... +25%))		
25 mA (24 V DC)		
<0.6 W		
375 V (peak value in accordance with EN 60079-11)		
300 V _{rms} (rated insulation voltage (overvoltage category II; degree of pollution 2, safe isolation as per EN 61010-1))		
2.5 kV (50 Hz, 1 min., test voltage)		
375 V (peak value in accordance with EN 60079-11)		
-20°C ... 60°C (any mounting position)		
10% ... 95% (non-condensing)		
Green LED (supply voltage)		
LED yellow (switching state)		
Red LED (line errors)		
V0		
PA 6.6-FR		
12.5 / 99 / 114.5 mm		
0.2 ... 2.5 mm ² / 0.2 ... 2.5 mm ² / 24 - 14		
0.2 ... 1.5 mm ² / 0.2 ... 1.5 mm ² / 24 - 16		
9.6 V		
10 mA		
25 mW		
253 V AC/DC		
CE-compliant, additionally EN 61326		
Ex II (1) G [Ex ia Ga] IIC		
Ex II (1) D [Ex ia Da] IIC		
Ex II 3G Ex nA IIC T4 Gc X		
[Ex ia Ga] IIC, [Ex ia Da] IIC, Ex nA IIC T4 Gc		
2		

Description	
NAMUR signal conditioner, intrinsically safe input, output with line fault transparency	
Screw connection	
Push-in connection	
Specifically for Yokogawa systems	
Screw connection	
Push-in connection	
Specifically for Honeywell systems	
Screw connection	
Push-in connection	

Ordering data		
Type	Order No.	Pcs./Pkt.
MACX MCR-EX-SL-NAM-NAM	2866006	1
MACX MCR-EX-SL-NAM-NAM-SP	2924883	1
MACX MCR-EX-SL-NAM-YO	2905723	1
MACX MCR-EX-SL-NAM-YO-SP	2905724	1
MACX MCR-EX-SL-NAM-HO	2907404	1
MACX MCR-EX-SL-NAM-HO-SP	2907405	1



MACX Analog – Ex i signal conditioners with functional safety

Solenoid drivers for controlling solenoid valves

In order to control intrinsically safe Ex i solenoid valves, you have to have an intrinsically safe control circuit. This is provided by the solenoid drivers that are available from Phoenix Contact.

The following must be taken into account when dimensioning your intrinsically safe control circuit:

- Valve
- Cable with corresponding resistance
- Solenoid driver

As a result, it may be the case that not all valves are compatible with the solenoid drivers.

Below is an extract from a table showing possible combinations of valves and solenoid drivers.

A complete and updated list (along with details of the technical data of suitable valves, the maximum cable lengths, and the maximum cable resistances of the individual combinations) can be found on the Internet at:

phoenixcontact.net/products

Example circuit

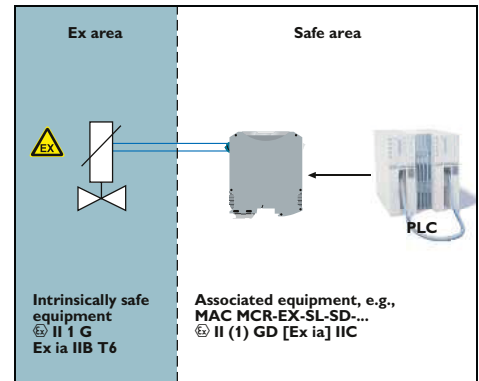

Valves overview				MACX Analog Ex solenoid drivers					
Manufacturer	Type Description		Ex certificate	Condition	MACX MCR-EX-SL-SD-21-25-LP	MACX MCR-EX-SL-SD-21-40-LP	MACX MCR-EX-SL-SD-24-48-LP	MACX MCR-EX-SL-SD-21-60-LP	
ASCO	Coil	195	LCIE 08 ATEX 6083			✓	✓	✓	
	Coil	302 (12 V)	INERIS 03 ATEX 0249X				✓	✓	
	Coil	302 (24 V)	INERIS 03 ATEX 0249X					✓	
Bürkert	Coil	AC 10, standard	PTB 01 ATEX 2101			✓	✓		
	Coil	AC 10, high-resistance	PTB 01 ATEX 2101			✓	✓		
	Coil	AC 21, standard	PTB 01 ATEX 2175	700 mW / 65°C		✓	✓		
	Coil	AC 21, high-resistance	PTB 01 ATEX 2175	700 mW / 65°C		✓	✓		
	Coil	AC 21, standard	PTB 01 ATEX 2175	900 mW / 45°C		✓	✓		
	Coil	AC 21, high-resistance	PTB 01 ATEX 2175	900 mW / 45°C		✓	✓		
	Coil	AC 21, standard	PTB 01 ATEX 2175	900 mW / 60°C		✓	✓		
	Coil	AC 21, high-resistance	PTB 01 ATEX 2175	900 mW / 60°C		✓	✓		
	Coil	G1 642735, standard		600 mW / 50°C		✓			
	Coil	G1 642735, high-resistance		600 mW / 50°C		✓			
	Coil	G1 642735, standard	PTB 01 ATEX 2173	800 mW / 40°C		✓	✓		
	Coil	G1 642735, high-resistance	PTB 01 ATEX 2173	800 mW / 40°C		✓	✓		
	Coil	G1 642735, standard	PTB 01 ATEX 2173	1,000 mW / 40°C		✓	✓		
Coil	G1 642735, high-resistance	PTB 01 ATEX 2173	1,000 mW / 40°C		✓	✓			
FESTO	Coil	MFH-...IA-SA-EX GBXE022AIAD03	PTB 03 ATEX 2097				✓	✓	
	Coil	(J)MFH-...BIA-SA-EX GBXE022AIAD03	PTB 03 ATEX 2097				✓	✓	
Norgren Herion	Coil	2050	PTB 07 ATEX 2019			✓	✓	✓	
	Coil	2051	PTB 07 ATEX 2019			✓	✓	✓	
	Coil	2052	PTB 07 ATEX 2019			✓	✓	✓	
	Coil	2053	PTB 07 ATEX 2019			✓	✓	✓	
	Coil	2085	PTB 06 ATEX 2001 U		✓				
	Coil	2086	PTB 06 ATEX 2001 U		✓	✓		✓	
	Coil	3039	PTB 03 ATEX 2134				✓		
Hörbiger	Piezo	P8 38x RF-Nx-SPN65	DMT 01 ATEX E026X	30 V type	✓	✓			
	Piezo	P20 381RF-NG-CPN61	DMT 01 ATEX E025X	30 V type	✓	✓			
Parker	Coil VZ07	488650.01	LCIE 02 ATEX 6024X			✓	✓		
	Coil VZ33	494035.10	LCIE 02 ATEX 6024X			✓	✓		
	Coil VZ08	488660.01	LCIE 02 ATEX 6024X			✓	✓		
	Coil VZ09	488670.01	LCIE 02 ATEX 6024X			✓	✓		
	Coil VZ95	482160.01	LCIE 02 ATEX 6024X	EEx ia IIB T6		✓	✓	✓	
	Coil VZ23	482870.01	LCIE 02 ATEX 6024X			✓	✓		
Samson	Coil	3701-11 (6 V)	PTB 02 ATEX 2178		✓				
	Coil	3701-12 (12 V)	PTB 02 ATEX 2178		✓	✓	✓		
	Coil	3701-13 (24 V)	PTB 02 ATEX 2178		✓	✓	✓		
	Coil	3963-11 (6 V)	PTB 01 ATEX 2085		✓				
	Coil	3963-12 (12 V)	PTB 01 ATEX 2085		✓	✓	✓		
	Coil	3963-13 (24 V)	PTB 01 ATEX 2085		✓	✓	✓		
	Coil	3964-11 (6 V)	PTB 02 ATEX 2047		✓				
	Coil	3964-12 (12 V)	PTB 02 ATEX 2047		✓	✓	✓		
	Coil	3964-13 (24 V)	PTB 02 ATEX 2047		✓	✓	✓		
	Coil	3965-11 (6 V)	PTB 05 ATEX 2044X		✓				
	Coil	3965-12 (12 V)	PTB 05 ATEX 2044X		✓	✓	✓		
	Coil	3965-13 (24 V)	PTB 05 ATEX 2044X		✓	✓	✓		
	Coil	3967-11 (6 V)	PTB 06 ATEX 2027		✓				
	Coil	3967-12 (12 V)	PTB 06 ATEX 2027		✓	✓	✓		
	Coil	3967-13 (24 V)	PTB 06 ATEX 2027		✓	✓	✓		
	Seitz	Pilot valve	PV 12F73 Ci oH	PTB 99 ATEX 2146		✓	✓	✓	
		Pilot valve	PV 12F73 Xi oH	PTB 00 ATEX 2030		✓	✓	✓	
Pilot valve		PV 12F73 Xi oH-2	PTB 00 ATEX 2030		✓	✓	✓		
Solenoid		11 G 52	PTB 01 ATEX 2020				✓		

Digital OUT
Solenoid drivers, Ex i

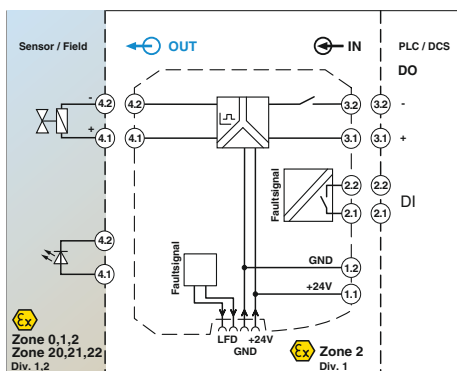
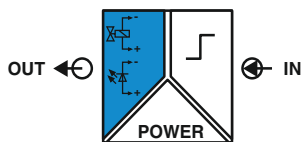

Solenoid driver, 48 mA current limitation with line fault detection

Functional Safety
Ex: EAC Ex IEC Ex KC-s
Housing width 12.5 mm

Solenoid drivers for the intrinsically safe control of Ex i solenoid valves, alarm transmitters or indicators installed in the Ex area.

- Input: logic (low/high signal)
- Output: 48 mA current limitation at 9.5 V, [Ex ia]
- Line fault detection (can be activated and deactivated)
 - Directly via signal channel
 - Or via switching output
- Transparent for test pulses
- Power supply and error indication possible via the DIN rail connector
- LED indicators for supply voltage, status, and fault in accordance with NAMUR NE 44
- Plug-in screw or Push-in connection technology
- Safe 3-way electrical isolation
- Up to SIL 2 in accordance with IEC 61508
- Installation in zone 2 permitted

Notes:
Information on the supply and error evaluation module, DIN rail connectors, system cabling, and marking material can be found from page 175

Input data	Switching level 0 signal ("L") Switching level 1 signal ("H") Current input signal Input impedance in the event of a line fault at the output
Transparent for test pulses	Yes
Output data	Output voltage Current limitation No-load voltage Internal resistance Immunity to short-circuiting Response time t_A Line error detection
Error message output	Switch contact Max. switching voltage Maximum switching current Short-circuit-proof
General data	Supply voltage range Current draw Power dissipation Electrical isolation
Ambient temperature range	-20°C ... 60°C (any mounting position)
Humidity	10% ... 95% (non-condensing)
Status indication	Green LED (supply voltage) LED yellow (switching state) Red LED (line errors)
Degree of protection	IP20
Inflammability class in accordance with UL 94	V0
Housing material	PA 6.6-FR
Dimensions W/H/D	12.5 / 112.5 / 114.5 mm
Screw connection rigid / flexible / AWG	0.2 ... 2.5 mm ² / 0.2 ... 2.5 mm ² / 24 - 14
Push-in connection rigid / flexible / AWG	0.2 ... 1.5 mm ² / 0.2 ... 1.5 mm ² / 24 - 16
Safety data as per ATEX	
Maximum output voltage U_o	25.3 V
Maximum output current I_o	94 mA
Maximum output power P_o	595 mW
Maximum voltage U_m	253 V AC/DC
Conformance/approvals	
Conformance	CE-compliant, additionally EN 61326
ATEX	Ex II (1) G [Ex ia Ga] IIC Ex II (1) D [Ex ia Da] IIC Ex II 3(1) G Ex nA [ia Ga] IIC T4 Gc X [Ex ia Ga] IIC, [Ex ia Da] IIC, Ex nA [ia Ga] IIC T4 Gc
IECEX	3
SIL in accordance with IEC 61508	

Technical data

0 V DC ... 5 V DC (open)	15 V DC ... 30 V DC	<12 mA	3 M Ω (high resistance (Mega Ω))
Yes			
≥ 9.36 V DC (at 48 mA)	>48 mA (with cable error detection)	>22.5 V DC	$\geq 269.3 \Omega$ (internal resistance R_i)
Yes		<30 ms	<50 Ω (short circuit on the line) >10 k Ω (line break)
N/O contact	30 V DC	50 mA	Yes
19.2 V DC ... 30 V DC (24 V DC -20%...+25%)	<90 mA (24 V DC)	<1.8 W	
375 V (peak value in accordance with EN 60079-11)	300 V _{rms} (rated insulation voltage (overvoltage category II; degree of pollution 2, safe isolation as per EN 61010-1))	2.5 kV (50 Hz, 1 min., test voltage)	
25.3 V	94 mA	595 mW	253 V AC/DC
CE-compliant, additionally EN 61326	Ex II (1) G [Ex ia Ga] IIC Ex II (1) D [Ex ia Da] IIC Ex II 3(1) G Ex nA [ia Ga] IIC T4 Gc X [Ex ia Ga] IIC, [Ex ia Da] IIC, Ex nA [ia Ga] IIC T4 Gc	3	

Ordering data

Description	Type	Order No.	Pcs./Pkt.
Solenoid driver, logic input, intrinsically safe output, line fault detection			
Screw connection	MACX MCR-EX-SL-SD-23-48-LFD	2924867	1
Push-in connection	MACX MCR-EX-SL-SD-23-48-LFD-SP	2924870	1

Digital OUT
Solenoid drivers, Ex i

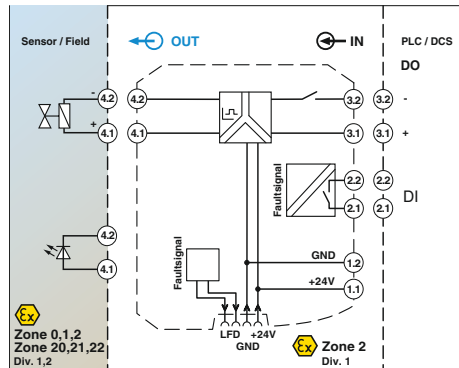
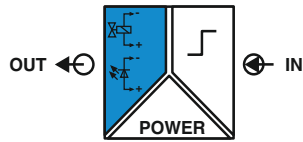

Solenoid driver, 25.1 mA current limitation with line fault detection

ERC Functional Safety
Ex: Ex i IEC 61508
Housing width 12.5 mm

Solenoid drivers for the intrinsically safe control of Ex i solenoid valves, alarm transmitters or indicators installed in the Ex area.

- Input: logic (low/high signal)
- Output: 25.1 mA current limitation at 4.64 V, [Ex ia]
- Line fault detection (can be activated and deactivated)
 - Directly via signal channel
 - Or via switching output
- Transparent for test pulses
- Power supply and error indication possible via the DIN rail connector
- LED indicators for supply voltage, status, and fault in accordance with NAMUR NE 44
- Plug-in screw or Push-in connection technology
- Safe 3-way electrical isolation
- Up to SIL 3 in accordance with IEC/EN 61508
- Installation in zone 2 permitted

Notes:

A list of suitable valves and notes for calculating a valve circuit are available from the download center at phoenixcontact.net/products.

Information on marking material can be found on page 178

Information on "Plug and play" connection using system cabling can be found from page 170

Input data

Switching level 0 signal ("L")
Switching level 1 signal ("H")
Current input signal
Input impedance in the event of a line fault at the output

Transparent for test pulses

Output data

Output voltage
Current limitation
No-load voltage
Internal resistance
Immunity to short-circuiting
Response time t_A
Line error detection

Error message output

Switch contact
Max. switching voltage
Maximum switching current
Short-circuit-proof

General data

Supply voltage range
Current draw
Power dissipation
Electrical isolation

Output/input, error message output

Ambient temperature range
Humidity
Status indication

Degree of protection
Inflammability class in accordance with UL 94
Housing material
Dimensions W/H/D
Screw connection rigid / flexible / AWG
Push-in connection rigid / flexible / AWG

Safety data as per ATEX

Maximum output voltage U_o
Maximum output current I_o
Maximum output power P_o
Maximum voltage U_m

Conformance/approvals

Conformance
ATEX

IECEX

SIL in accordance with IEC 61508

Technical data

0 V DC ... 5 V DC (open)
15 V DC ... 30 V DC
<12 mA
3 M Ω (high resistance (Mega Ω))

Yes

≥ 4.64 V DC (at 25.1 mA)
>25.1 mA (with cable error detection)
>21.1 V DC
 ≥ 641 Ω (internal resistance R_i)
Yes
<30 ms
<50 Ω (short circuit on the line)
>10 k Ω (line break)

N/O contact

30 V DC
50 mA
Yes

19.2 V DC ... 30 V DC (24 V DC -20%...+25%)
<50 mA (24 V DC)
<0.8 W

375 V (peak value in accordance with EN 60079-11)
300 V_{rms} (rated insulation voltage (overvoltage category II); degree of pollution 2, safe isolation as per EN 61010-1)
2.5 kV (50 Hz, 1 min., test voltage)

-20°C ... 60°C (any mounting position)
10% ... 95% (non-condensing)
Green LED (supply voltage)
LED yellow (switching state)
Red LED (line errors)

IP20
V0
PA 6.6-FR
12.5 / 112.5 / 114.5 mm
0.2 ... 2.5 mm² / 0.2 ... 2.5 mm² / 24 - 14
0.2 ... 1.5 mm² / 0.2 ... 1.5 mm² / 24 - 16

23.98 V
37.4 mA
224 mW
253 V AC/DC

CE-compliant, additionally EN 61326
Ex i IIC
Ex ia IIC
Ex ia IIC
Ex ia IIC
Ex ia IIC T4 Gc X
[Ex ia Ga] IIC, [Ex ia Da] IIC, Ex nA [ia Ga] IIC T4 Gc
3

Ordering data

Description

Solenoid driver, logic input, intrinsically safe output, line fault detection

Screw connection
Push-in connection

Type

MACX MCR-EX-SL-SD-21-25-LFD
MACX MCR-EX-SL-SD-21-25-LFD-SP

Order No.

2905669
2905674

Pcs./Pkt.

1
1

Digital OUT
Solenoid drivers, Ex i

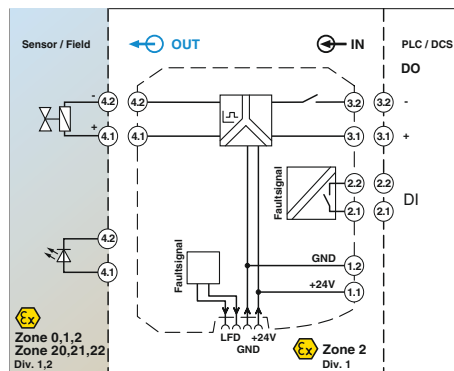
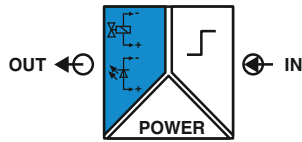

Solenoid driver, 48 mA current limitation with line fault detection

ERC Functional Safety
Ex:
Housing width 12.5 mm

Solenoid drivers for the intrinsically safe control of Ex i solenoid valves, alarm transmitters or indicators installed in the Ex area.

- Input: logic (low/high signal)
- Output: 48 mA current limitation at 9.7 V, [Ex ia]
- Line fault detection (can be activated and deactivated)
 - Directly via signal channel
 - Or via switching output
- Transparent for test pulses
- Power supply and error indication possible via the DIN rail connector
- LED indicators for supply voltage, status, and fault in accordance with NAMUR NE 44
- Plug-in screw or Push-in connection technology
- Safe 3-way electrical isolation
- Up to SIL 3 in accordance with IEC/EN 61508
- Installation in zone 2 permitted

Notes:
A list of suitable valves and notes for calculating a valve circuit are available from the download center at phoenixcontact.net/products .
Information on marking material can be found on page 178
Information on "Plug and play" connection using system cabling can be found from page 170

Input data	Switching level 0 signal ("L") Switching level 1 signal ("H") Current input signal Input impedance in the event of a line fault at the output
Output data	Output voltage Current limitation No-load voltage Internal resistance Immunity to short-circuiting Response time t_A Line error detection
Error message output	Switch contact Max. switching voltage Maximum switching current Short-circuit-proof
General data	Supply voltage range Current draw Power dissipation Electrical isolation
Safety data as per ATEX	Maximum output voltage U_o Maximum output current I_o Maximum output power P_o Maximum voltage U_m
Conformance/approvals	Conformance ATEX
IECEX	SIL in accordance with IEC 61508

Technical data		
0 V DC ... 5 V DC (open)	15 V DC ... 30 V DC	<12 mA
3 M Ω (high resistance (Mega Ω))	Yes	
≥ 9.7 V DC (at 48 mA)	>48 mA (with cable error detection)	>24.3 V DC
$\geq 297 \Omega$ (internal resistance R_i)	Yes	<30 ms
>10 k Ω (line break)	N/O contact	30 V DC
	50 mA	Yes
19.2 V DC ... 30 V DC (24 V DC -20%...+25%)	<90 mA (24 V DC)	<1.62 W
375 V (peak value in accordance with EN 60079-11)	300 V_{rms} (rated insulation voltage (overvoltage category II; degree of pollution 2, safe isolation as per EN 61010-1))	2.5 kV (50 Hz, 1 min., test voltage)
-20°C ... 60°C (any mounting position)	10% ... 95% (non-condensing)	Green LED (supply voltage)
		LED yellow (switching state)
		Red LED (line errors)
		IP20
		V0
		PA 6.6-FR
		12.5 / 112.5 / 114.5 mm
		0.2 ... 2.5 mm ² / 0.2 ... 2.5 mm ² / 24 - 14
		0.2 ... 1.5 mm ² / 0.2 ... 1.5 mm ² / 24 - 16
27.06 V	91.11 mA	616 mW
253 V AC/DC		
CE-compliant, additionally EN 61326	II (1) G [Ex ia Ga] IIC	II (1) D [Ex ia Da] IIIC
	II 3(1) G Ex nA [ia Ga] IIC T4 Gc X	[Ex ia Ga] IIC, [Ex ia Da] IIIC, Ex nA [ia Ga] IIC T4 Gc
		3

Description	Solenoid driver, logic input, intrinsically safe output, line fault detection
	Screw connection
	Push-in connection

Ordering data		
Type	Order No.	Pcs./Pkt.
MACX MCR-EX-SL-SD-24-48-LFD	2906155	1
MACX MCR-EX-SL-SD-24-48-LFD-SP	2906156	1

Digital OUT
Solenoid drivers, Ex i

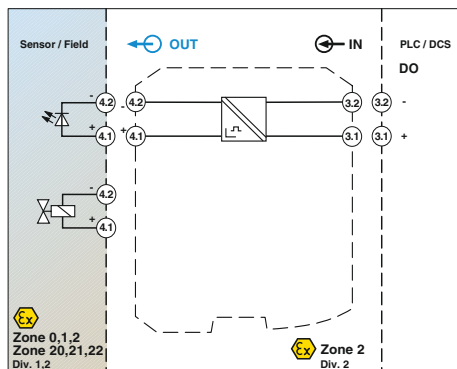
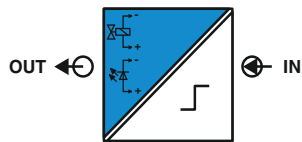

Solenoid driver, current limitation 25 mA

Functional Safety
Ex: EAC Ex IEC Ex
Housing width 12.5 mm

Solenoid drivers for controlling intrinsically safe solenoid valves, alarm transmitters, and indicators installed in Ex areas.

- 20 to 30 V DC input
- Output [Ex ia]
- Various output characteristic curves compatible with the commercial solenoid valves
- Loop-powered: The required power is supplied via the control signal on the input side
- Mechanically compatible with DIN rail connector
- Galvanic 2-way isolation
- Up to SIL 3 in accordance with IEC 61508
- Installation in zone 2 permitted

Notes:
A list of suitable valves and notes for calculating a valve circuit are available from the download center at phoenixcontact.net/products .
Information on marking material can be found on page 178
Information on "Plug and play" connection using system cabling can be found from page 170

Input data	
Voltage input signal	19.2 V DC ... 30 V DC (24 V DC -20%...+25%)
Current input signal	45 mA (at U _e = 24 V DC)
Output data	
Output voltage	5.5 V DC (at 25 mA)
Current limitation	25 mA
No-load voltage	21.9 V DC
Internal resistance	641.1 Ω (internal resistance R _i)
Immunity to short-circuiting	Yes
Response time t _A	20 ms
General data	
Power dissipation	<0.845 W
Temperature coefficient	0.01%/K
Electrical isolation	
Output/input	375 V (peak value in accordance with EN 60079-11) 300 V _{rms} (rated insulation voltage (overvoltage category II; degree of pollution 2, safe isolation as per EN 61010-1)) 2.5 kV (50 Hz, 1 min., test voltage)
Ambient temperature range	-40°C ... 60°C (any mounting position)
Status indication	Yellow LED (switching state / status, lights up when output circuit is active)
Degree of protection	IP20
Inflammability class in accordance with UL 94	V0
Dimensions W/H/D	12.5 / 99 / 114.5 mm
Screw connection rigid / flexible / AWG	0.2 ... 2.5 mm ² / 0.2 ... 2.5 mm ² / 24 - 14
Push-in connection rigid / flexible / AWG	0.2 ... 1.5 mm ² / 0.2 ... 1.5 mm ² / 24 - 16
Safety data as per ATEX	
Maximum output voltage U _o	25.1 V
Maximum output current I _o	39 mA
Maximum output power P _o	245 mW
Maximum voltage U _m	253 V AC (125 V DC)
Conformance/approvals	
Conformance	CE-compliant, additionally EN 61326
ATEX	Ex II (1) G [Ex ia Ga] IIC/IIB/IIA Ex II (1) D [Ex ia Da] IIIC Ex II 3 (1)G Ex nA [ia IIC Ga] IIC T4 Gc X
IECEX	[Ex ia Ga] IIC/IIB/IIA, [Ex ia Da] IIIC, Ex nA [ia IIC Ga] IIC T4 Gc
UL, USA/Canada	Class I Div 2; IS for Class I, II, III Div 1
SIL in accordance with IEC 61508	3

Technical data

Input data	
Voltage input signal	19.2 V DC ... 30 V DC (24 V DC -20%...+25%)
Current input signal	45 mA (at U _e = 24 V DC)
Output data	
Output voltage	5.5 V DC (at 25 mA)
Current limitation	25 mA
No-load voltage	21.9 V DC
Internal resistance	641.1 Ω (internal resistance R _i)
Immunity to short-circuiting	Yes
Response time t _A	20 ms
General data	
Power dissipation	<0.845 W
Temperature coefficient	0.01%/K
Output/input	375 V (peak value in accordance with EN 60079-11) 300 V _{rms} (rated insulation voltage (overvoltage category II; degree of pollution 2, safe isolation as per EN 61010-1)) 2.5 kV (50 Hz, 1 min., test voltage)
Ambient temperature range	-40°C ... 60°C (any mounting position)
Status indication	Yellow LED (switching state / status, lights up when output circuit is active)
Degree of protection	IP20
Inflammability class in accordance with UL 94	V0
Dimensions W/H/D	12.5 / 99 / 114.5 mm
Screw connection rigid / flexible / AWG	0.2 ... 2.5 mm ² / 0.2 ... 2.5 mm ² / 24 - 14
Push-in connection rigid / flexible / AWG	0.2 ... 1.5 mm ² / 0.2 ... 1.5 mm ² / 24 - 16
Safety data as per ATEX	
Maximum output voltage U _o	25.1 V
Maximum output current I _o	39 mA
Maximum output power P _o	245 mW
Maximum voltage U _m	253 V AC (125 V DC)
Conformance/approvals	
Conformance	CE-compliant, additionally EN 61326
ATEX	Ex II (1) G [Ex ia Ga] IIC/IIB/IIA Ex II (1) D [Ex ia Da] IIIC Ex II 3 (1)G Ex nA [ia IIC Ga] IIC T4 Gc X
IECEX	[Ex ia Ga] IIC/IIB/IIA, [Ex ia Da] IIIC, Ex nA [ia IIC Ga] IIC T4 Gc
UL, USA/Canada	Class I Div 2; IS for Class I, II, III Div 1
SIL in accordance with IEC 61508	3

Description
Solenoid driver , loop-powered, output intrinsically safe
Screw connection
Push-in connection

Ordering data

Type	Order No.	Pcs./Pkt.
MACX MCR-EX-SL-SD-21-25-LP	2865492	1
MACX MCR-EX-SL-SD-21-25-LP-SP	2924113	1

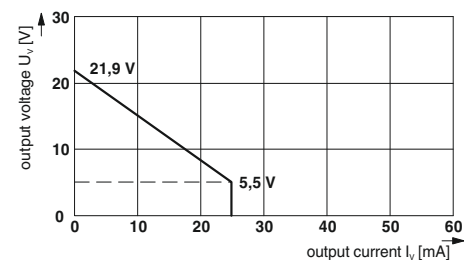



Solenoid driver, current limitation 40 mA



Solenoid driver, current limitation 48 mA



Solenoid driver, current limitation 58 mA, [Ex ia] IIB

Functional Safety
Ex: EAC Ex IEC IEC IEC
Housing width 12.5 mm

Technical data
19.2 V DC ... 30 V DC (24 V DC -20%...+25%) 85 mA (at U _o = 24 V DC)
10 V DC (at 40 mA) 40 mA 21.9 V DC 287 Ω (internal resistance R _i) Yes 20 ms
<1.055 W 0.01%/K
375 V (peak value in accordance with EN 60079-11) 300 V _{rms} (rated insulation voltage (overvoltage category II; degree of pollution 2, safe isolation as per EN 61010-1)) 2.5 kV (50 Hz, 1 min., test voltage)
-40°C ... 60°C (any mounting position, pay attention to the derating curve in the data sheet) Yellow LED (switching state / status, lights up when output circuit is active) IP20 V0 12.5 / 99 / 114.5 mm 0.2 ... 2.5 mm ² / 0.2 ... 2.5 mm ² / 24 - 14 0.2 ... 1.5 mm ² / 0.2 ... 1.5 mm ² / 24 - 16
25.1 V 87 mA 550 mW 253 V AC (125 V DC)
CE-compliant, additionally EN 61326 Ex II (1) G [Ex ia Ga] IIC/II B/II A Ex II (1) D [Ex ia Da] IIIC Ex II 3 (1) G Ex nA [ia IIC Ga] IIC T4 Gc X [Ex ia Ga] IIC/II B/II A Class I Div 2; IS for Class I, II, III Div 1 3

Functional Safety
Ex: EAC Ex IEC IEC IEC
Housing width 12.5 mm

Technical data
19.2 V DC ... 30 V DC (24 V DC -20%...+25%) 85 mA (at U _o = 24 V DC)
10.5 V DC (at 48 mA) 48 mA 24 V DC 275.7 Ω (internal resistance R _i) Yes 20 ms
<1.41 W 0.01%/K
375 V (peak value in accordance with EN 60079-11) 300 V _{rms} (rated insulation voltage (overvoltage category II; degree of pollution 2, safe isolation as per EN 61010-1)) 2.5 kV (50 Hz, 1 min., test voltage)
-40°C ... 60°C (any mounting position, pay attention to the derating curve in the data sheet) Yellow LED (switching state / status, lights up when output circuit is active) IP20 V0 12.5 / 99 / 114.5 mm 0.2 ... 2.5 mm ² / 0.2 ... 2.5 mm ² / 24 - 14 0.2 ... 1.5 mm ² / 0.2 ... 1.5 mm ² / 24 - 16
27.7 V 101 mA 697 mW 253 V AC (125 V DC)
CE-compliant, additionally EN 61326 Ex II (1) G [Ex ia Ga] IIC/II B/II A Ex II (1) D [Ex ia Da] IIIC Ex II 3 (1) G Ex nA [ia IIC Ga] IIC T4 Gc X [Ex ia Ga] IIC/II B/II A Class I Div 2; IS for Class I, II, III Div 1 3

Functional Safety
Ex: EAC Ex IEC IEC IEC
Housing width 12.5 mm

Technical data
19.2 V DC ... 30 V DC (24 V DC -20%...+25%) 95 mA (at U _o = 24 V DC)
12.9 V DC (at 58 mA) 58 mA 21.9 V DC 133.4 Ω (internal resistance R _i) Yes 20 ms
<1.325 W 0.01%/K
375 V (peak value in accordance with EN 60079-11) 300 V _{rms} (rated insulation voltage (overvoltage category II; degree of pollution 2, safe isolation as per EN 61010-1)) 2.5 kV (50 Hz, 1 min., test voltage)
-40°C ... 60°C (any mounting position, pay attention to the derating curve in the data sheet) Yellow LED (switching state / status, lights up when output circuit is active) IP20 V0 12.5 / 99 / 114.5 mm 0.2 ... 2.5 mm ² / 0.2 ... 2.5 mm ² / 24 - 14 0.2 ... 1.5 mm ² / 0.2 ... 1.5 mm ² / 24 - 16
25.1 V 188 mA 1.18 W 253 V AC (125 V DC)
CE-compliant, additionally EN 61326 Ex II (1) G [Ex ia Ga] II B/II A Ex II (1) D [Ex ia Da] IIIC Ex II 3 (1) G Ex nA [ia II B Ga] IIC T4 Gc X [Ex ia Ga] II B/II A Class I Div 2; IS for Class I, II, III Div 1 3

Ordering data		
Type	Order No.	Pcs./Pkt.
MACX MCR-EX-SL-SD-21-40-LP	2865764	1
MACX MCR-EX-SL-SD-21-40-LP-SP	2924139	1

Ordering data		
Type	Order No.	Pcs./Pkt.
MACX MCR-EX-SL-SD-24-48-LP	2865609	1
MACX MCR-EX-SL-SD-24-48-LP-SP	2924126	1

Ordering data		
Type	Order No.	Pcs./Pkt.
MACX MCR-EX-SL-SD-21-60-LP	2865515	1
MACX MCR-EX-SL-SD-21-60-LP-SP	2924100	1

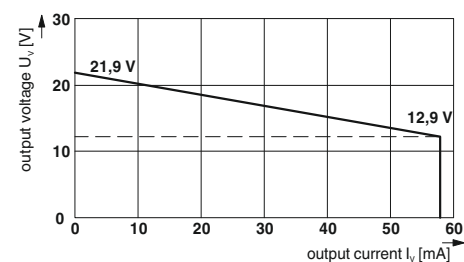
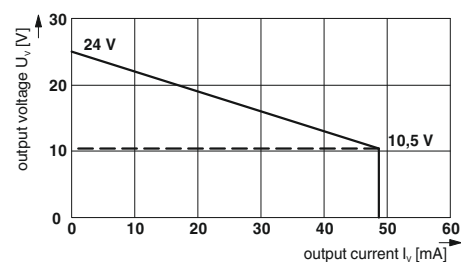
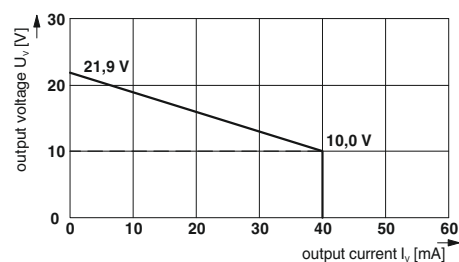

Limit values, threshold value switches

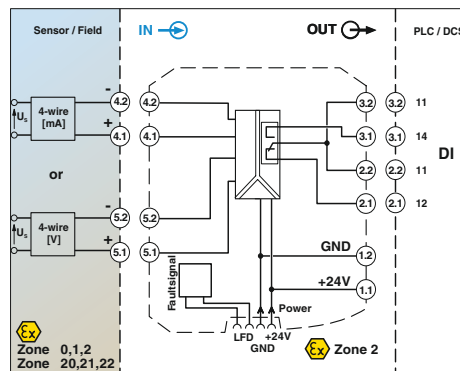
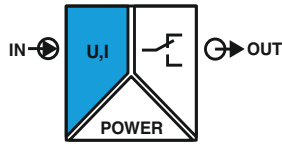

new

Configurable, with relay PDT output



Housing width 12.5 mm

Limit switch with unlimited configurable limit values

- Input [Ex ia] for analog standard current and voltage signals from Ex area for switching analog limit values
- Safe 3-way isolation
- Configure limit values via DIP switch
- PDT relay at output
- Limiting continuous current up to 6 A
- Energy can be supplied via the DIN rail connector
- Status and error indicator LEDs
- Up to SIL 3 in accordance with IEC 61508
- PLC in accordance with ISO 13849
- Installation in zone 2 possible

Input data

Voltage input signal
Total error of the voltage input maximum
Current input signal
Total error of the current input maximum
Input resistance
Switching points

Current/voltage input

Switching hysteresis
Line error detection

Switching output

Contact type
Maximum switching current
Mechanical service life
Switching voltage

General data

Supply voltage range
Current consumption, maximum
Current consumption, typical
Current draw
Power consumption
Power dissipation
Temperature coefficient
Step response (0 - 99%)
Switching point accuracy
Maximum transmission error
Electrical isolation

Input/output
Input/output/supply, DIN rail connector

Ambient temperature (operation)
Ambient temperature (storage/transport)
Humidity
Altitude
Inflammability class in accordance with UL 94
Dimensions W/H/D

Conformance/approvals

Conformance
ATEX

UL, USA/Canada
SIL in accordance with IEC 61508

Technical data

0.1 V ... 10 V
0.1 V ... 10.5 V (maximum range)
± 10 mV
0.2 mA ... 20 mA
0.18 mA ... 21 mA (maximum range)
± 20 µA
<28 Ω / >100 kΩ
- / configurable via DIP switch (in 1.25% increments) and potentiometer (linearly up to 2% of the switching threshold set via the DIP switch)
off: approx. 0.5%, on: approx. 1%
Break U <50 mV, I <0.1 mA
Short circuit U >10.8 V, I >21.1 mA
Relay output
1 PDT
≤4 A AC (cos phi = 1)
≤10⁷ cycles
≤250 V AC
≤120 V DC
9.6 V DC ... 30 V DC (12 V DC ... 24 V DC (-20% ... +25%))
90 mA (10 V DC)
38 mA (24 V DC)
≤30 mA (30 V DC)
≤1.2 W
<0.9 W
0.01%/K
≤22 ms
<0.1%
0.1%
375 V (peak value in accordance with EN 60079-11)
300 V_{rms} (rated insulation voltage (overvoltage category II); degree of pollution 2, safe isolation as per EN 61010-1)
2.5 kV (50 Hz, 1 min., test voltage)
-20°C ... 65°C (any mounting position)
-40°C ... 85°C
5% ... 95% (non-condensing)
≤2,000 m
V0
12.5 / 99 / 114.5 mm
CE-compliant, additionally EN 61326
Ex II (1) G [Ex ia Ga] IIC
Ex II (1) D [Ex ia Da] IIIC
Ex II 3(1) G Ex ec nC [ia Ga] IIC T4 Gc
UL applied for
2 (single-channel)
3 (two-channel)

Ordering data

Description	Ordering data		
	Type	Order No.	Pcs./Pkt.
Screw connection	MACX MCR-EX-SL-UI-REL	2906164	1
Spring-cage connection	MACX MCR-EX-SL-UI-REL-SP	2906165	1



Termination Carriers for MACX Analog signal conditioners



TC... Termination Carriers are compact solutions for quickly and smoothly connecting DIN rail devices from the MACX Analog series to input and output cards of automation systems using system cabling.

The Termination Carriers combine the advantages of modular DIN rail devices with those offered by plug and play rapid cabling solutions to provide a consistent solution for system technology.

Termination carriers are also available for MINI Analog Pro and PSR safety devices.

Compact

- Saves up to 30% of space due to compact design

Rugged and reliable

- Stable, vibration-resistant aluminum carrier device profile
- PCB is completely decoupled from modules
- PCB without active components
- Redundant supply and monitoring in separate DIN rail module

Easy maintenance

- Use of standard DIN rail devices
- Easy access to connection points
- Quick and safe module connection with plug-in and coded cable sets

Flexible

- Horizontal or vertical DIN rail mounting
- Profile section without pitch markings for I/O cards with specific number of channels
- Can be specifically adapted for I/O cards of various automation systems with different system plug types



Select standard DIN rail device



Select module carrier



Select controller-specific front adapter and system cable

Termination Carriers for MACX Analog signal conditioners

The **TC-D37SUB-ADIO16-EX-P-UNI** universal Termination Carrier is a compact solution for connecting signal conditioners from the MACX Analog series to analog or binary input and output cards of automation systems.

The **TC-D37SUB-AIO16-EX-PS-UNI** termination-carrier design, when combined with the MACX MCR-S-MUX HART multiplexer, also enables communication between HART-compatible field devices and a management system.

The **TC-D37SUB-ADIO16-2EX-P-UNI** universal Termination Carrier is a compact solution for connecting two-channel signal conditioners from the MACX Analog series to analog or binary input and output cards of automation systems.

- Connection of up to 16 single-channel (Ex i-)signal conditioners
- Universal 1:1 signal routing to a 37-pos. D-SUB connector
- For system cables with D-SUB socket and open ends for universal connection
- Redundant supply and monitoring in separate DIN rail module

Notes:
You will find information about signal conditioners from the MACX Analog product range in the INTERFACE catalog or at phoenixcontact.com.
You can find information about available system cables for D-SUB connectors in the INTERFACE catalog or at phoenixcontact.com.
Contact us: specific Termination Carriers designs for I/O modules of various automation systems are available, planned or can be implemented in accordance with your specification.



EAC
 Ex: **Ex**
 Housing width 242 mm

General data
Connection to the control system level
No. of pos.
Maximum operating voltage
Maximum permissible current
Rated insulation voltage
Rated surge voltage
Degree of pollution
Overvoltage category
Air clearances and creepage distances
Ambient temperature range
Shock
Vibration (operation)
Dimensions W/H/D
EMC note
Power supply via power module
Input voltage range
Redundant supply
Polarization and surge protection
Fuse
Status indication
Switching output
Maximum switching voltage

Technical data	
D-SUB pin strip	37
<30 V DC (per signal/channel)	
1 A (signal/channel)	
50 V (basic insulation)	
0.5 kV	
2	
II	
DIN EN 50178 (basic insulation)	
-20°C ... 60°C (please observe module specifications)	
15g, in accordance with IEC 60068-2-27	
2g, in accordance with IEC 60068-2-6	
242 / 170 / 160 mm	
19.2 V DC ... 30 V DC	
Yes, decoupled from diodes	
Yes	
2x 2.5 A on PCB, slow-blow (replaceable)	
1x red LED (error)	
2x green LEDs (PWR1 and PWR2)	
1 N/C contact (alarm = open)	
50 V DC (0.3 A) / 30 V DC (2 A) / 33 V AC (2 A)	

Description
Universal Termination Carrier for 16 single-channel MACX MCR isolators
- With connection for multiplexer
Universal Termination Carrier for 16 two-channel MACX MCR isolators

Ordering data		
Type	Order No.	Pcs./Pkt.
TC-D37SUB-ADIO16-EX-P-UNI	2924854	1
TC-D37SUB-AIO16-EX-PS-UNI	2902932	1
TC-2D37SUB-ADIO32-2EX-P-UNI	2904684	1

Power and fault signaling module
HART multiplexer, 32-channel

Accessories		
TC-MACX-MCR-PTB	2904673	1
MACX MCR-S-MUX	2865599	1

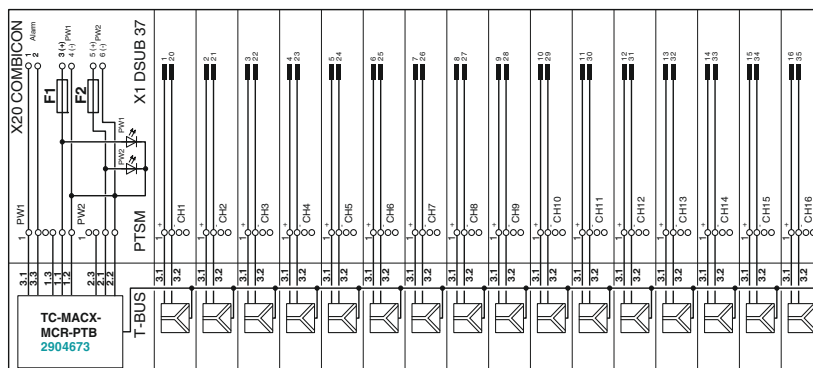

TC-D37SUB-ADIO16-EX-P-UNI and TC-D37SUB-AIO16-EX-PS-UNI connection scheme

Multiplexers for HART signals

Multiplexers for digital connection of HART-compatible field devices (such as measuring transducers or control valves) to a PC or management system.

- Supports online configuration and diagnostics for the connected HART-compatibles field devices
- Constant documentation of process variables and states
- 32 HART channels per multiplexer
- Up to 128 HART multiplexers at one PC interface
- Communication via software tool (e.g. HART OPC Server) using RS-485 interface
- Electrical isolation between auxiliary energy, RS-485 bus and the HART channels
- HART field devices are accessed at the same time that the measurement signal is transmitted without affecting measured value processing
- HART field devices connected via universal HART connection boards; direct connection if processing non-Ex signals, with separate Ex i signal isolator connected upstream if processing Ex signals
- Power supplied via HART connection board



HART multiplexer, 32-channel

ERIC

Housing width 35.2 mm

Technical data

Field devices interface (HART)	Channels Connection method Signal HART specification	16 or 32; adjustable using a switch Flat-ribbon cable, 14-pos. (inclusive) HART FSK HART Field Communication Protocol Rev. 6.0 (downward compatible up to Rev 4.0); FSK Physical Layer Specification (Rev. 8.1) Two yellow "Tx" and "Rx" "HART" LEDs Red "ERR" LED (flashes in case of an error in the HART bus)
Data transmission display	Display error	
RS-485 interface	Connection method Signal Data flow control/protocols	D-SUB-9 female connector RS-485 Compatible with OPC HART server, PDM, PRM, and FDT/DTM
Number of HART multiplexers per bus segment	Address setting Data rate	Max 31 0...127; using a rotary switch at the front 9600 / 19200 / 38400 / 57600 [bps]; via rotary switch at the front
Transmission length	Display	≤1200 m Two yellow "Tx" and "Rx" "RS-485" LEDs
General data	Supply voltage range Nominal supply voltage Current consumption Power consumption Operating voltage display Undervoltage monitoring	18 V ... 31.2 V 24 V DC 55 mA 1.35 W Green "PWR" LED Yes (no faulty devices / output states)
	Galvanic isolation of HART signal/RS-485 Galvanic isolation of HART signals between each other Galvanic isolation of HART signal/supply Galvanic isolation of RS-485/supply Error monitoring	350 V AC 100 V DC (capacitive) 350 V AC 350 V AC Processor error: The "PWR" LED flashes; error in the HART communication: the "ERR" LED flashes
	Ambient temperature range Humidity Dimensions W/H/D	-20°C ... 60°C ≤95% (non-condensing) 35.2 / 99 / 114.5 mm
Conformance/approvals	Conformance	CE-compliant

Ordering data

Description	Type	Order No.	Pcs./Pkt.
HART multiplexer, 32-channel, including two 14-conductor flat-ribbon cable	MACX MCR-S-MUX	2865599	1

Accessories

Universal Termination Carrier for 16 single-channel MACX MCR isolators - With connection for multiplexer	TC-D37SUB-AIO16-EX-PS-UNI	2902932	1
Module carrier for 16 MINI Analog channels, power and feed-through module - With connection for MACX MCR-S-MUX HART multiplexer	TC-D37SUB-AIO16-M-PS-UNI	2902934	1
HART connection board	MACX MCR-S-MUX-TB	2308124	1
Interface converter	PSM-ME-RS232/RS485-P	2744416	1
Repeater, for electrical isolation and increased range	PSM-ME-RS485/RS485-P	2744429	1

Accessories

Programming adapters

The IFS-USB-PROG-ADAPTER programming adapter is used for configuring Phoenix Contact Interface modules with S-PORT interface.

The adapter is used with FDT/DTM software or ANALOG-CONF software. For programming the MACX Analog, MINI Analog Pro, and MINI Analog.



Description	Ordering data		
	Type	Order No.	Pcs./Pkt.
Programming adapter for configuring modules with S-PORT interface	IFS-USB-PROG-ADAPTER	2811271	1

Accessories

Shield fast connection

- For connecting cable shielding to cable terminal points
- Can be connected to PLUGTRAB PT
- Easy assembly



Description	Ordering data		
	Type	Order No.	Pcs./Pkt.
Shield fast connection , for connection to PLUGTRAB PT			
For Ø 3-6 mm	SSA 3-6	2839295	10
For Ø 5-10 mm	SSA 5-10	2839512	10

Accessories

ME 6,2 TBUS... DIN rail connectors

DIN rail connector (5-pos.) for bridging the supply voltage of 12.5 mm wide MACX analog modules

- Reduces wiring costs
- System can be extended or module replaced even while process is active
- Inter-extendable



Description	Ordering data		
	Type	Order No.	Pcs./Pkt.
DIN rail connector , for bridging the supply voltage, can be snapped onto 35 mm DIN rails in accordance with EN 60715, UL-approved Color: gray Color: green	ME 6,2 TBUS-2 1,5/5-ST-3,81 GY ME 6,2 TBUS-2 1,5/5-ST-3,81 GN	2695439 2869728	10 10

Accessories

Dummy – MACX MCR-EX-DUMMY-ISOLATOR

Dummy module with no function for connecting unused intrinsically safe signal cables, with plug-in connection terminal blocks.



Description	Ordering data		
	Type	Order No.	Pcs./Pkt.
Dummy module with no function with screw connection with Push-in connection	MACX MCR-EX-DUMMY-ISOLATOR MACX MCR-EX-DUMMY-ISOLATOR-SP	2904970 2905846	1 1

Accessories

Power and error message modules

Power and fault signaling module for feeding the 24 V supply voltage to the DIN rail connectors and signaling line faults and power supply failures.

- One-time or redundant supply, decoupled from diode, protected against polarization
- Supply current up to 3.75 A
- Relay output (PDT) and flashing LED for error messages
- Error message in the event of a power supply failure or fuse fault
- Bus cable fault message for MACX MCR-...(2)NAM... devices connected via DIN rail connectors
- Replaceable fuse
- Installation in zone 2 permitted

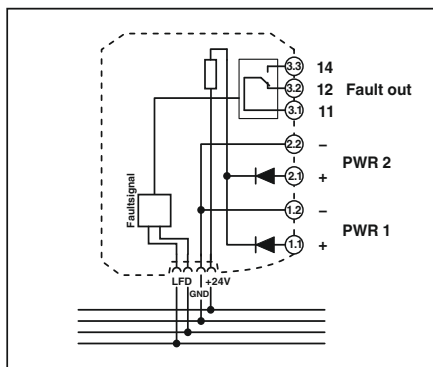

Ex n



Ex: Ex n

Housing width 17.5 mm

Technical data

Input data	
Voltage input signal	19.2 V DC ... 30 V DC (24 V DC -20%...+25%)
Redundant supply	Yes, decoupled from diodes
Polarization and surge protection	Yes
Output data	
Maximum output signal	3.75 A
Output voltage	Input voltage - max 0.8 V at 3.75 A
Switching output	
Contact type	Relay
Contact material	1 PDT
Max. switching voltage	Gold (Au)
General data	50 V AC (2 A) / 30 V DC (2 A) / 50 V DC (0.22 A)
Ambient temperature range	-20°C ... 60°C (any mounting position)
Humidity	5% ... 95% (non-condensing)
Fuse	5 A (replaceable), slow-blow 250 V AC
Status indication	1 x red LED (error) 2 x green LEDs (PWR1 and PWR2)
Inflammability class in accordance with UL 94	V0
Housing material	Polyamide (PA 6.6)
Dimensions W/H/D	17.5 / 99 / 114.5 mm
Screw connection rigid / flexible / AWG	0.2 ... 2.5 mm ² / 0.2 ... 2.5 mm ² / 24 - 14
Push-in connection rigid / flexible / AWG	0.2 ... 1.5 mm ² / 0.2 ... 1.5 mm ² / 24 - 16
Conformance/approvals	
Conformance	CE-compliant
ATEX	II 3 G Ex nA nC IIC T4 Gc X
IECEX	Ex nA nC IIC T4 Gc X
UL, USA/Canada	UL 61010 Listed Class I, Div. 2, Groups A, B, C, D T5 Class I, Zone 2, Group IIC

Ordering data

Description	Type	Order No.	Pcs./Pkt.
Supply and error message module , including the relevant DIN rail connector ME 17,5 TBUS 1,5/5-ST-3,81 GN	Screw connection	MACX MCR-PTB	2865625 1
	Push-in connection	MACX MCR-PTB-SP	2924184 1

Accessories

Power and error message modules

Power and fault signaling module for supplying the 24 V supply voltage to the DIN rail connectors of the MACX Analog Termination Carriers and signaling line faults and energy supply failures.

- One-time or redundant supply, decoupled from diode, protected against polarization
- Feed-in current up to 2 A protected by Termination Carrier PCB
- Relay output (PDT) and flashing LED for error messages
- Error message in the event of a power supply failure or fuse fault
- Bus cable fault message for MACX MCR-...(2)NAM... devices connected via DIN rail connectors
- Installation in zone 2 possible



Housing width 17.5 mm

Input data
Voltage input signal
Redundant supply
Polarization and surge protection
Output data
Maximum output signal
Output voltage
Switching output
Contact type
Contact material
Max. switching voltage
General data
Ambient temperature range
Humidity
Status indication
Inflammability class in accordance with UL 94
Housing material
Dimensions W/H/D
Screw connection rigid / flexible / AWG
Push-in connection rigid / flexible / AWG
Conformance/approvals
Conformance
ATEX
IECEX
UL, USA/Canada

Technical data	
19.2 V DC ... 30 V DC	Yes, decoupled from diodes
Yes	Yes
2 A (redundancy range)	Input voltage - 0.7 V
Relay	1 PDT
Gold (Au)	50 V AC/DC (33 V AC (2 A) / 50 V DC (0.3 A) / 30 V DC (2 A))
-20°C ... 60°C (only on Termination Carrier)	5% ... 95% (non-condensing)
1 x red LED (error)	2 x green LEDs (PWR1 and PWR2)
V0	Polyamide (PA 6.6)
17.5 / 99 / 114.5 mm	0.2 ... 2.5 mm ² / 0.2 ... 2.5 mm ² / 24 - 14
0.2 ... 2.5 mm ² / 0.2 ... 2.5 mm ² / 24 - 14	CE-compliant
	Ex II 3 G Ex nA nC IIC T4 Gc X
	Ex nA nC IIC T4 Gc X
	UL 61010 Listed
	Class I, Div. 2, Groups A, B, C, D T5
	Class I, Zone 2, Group IIC

Description
Power and fault signaling module without integrated fuse
Screw connection

Ordering data		
Type	Order No.	Pcs./Pkt.
TC-MACX-MCR-PTB	2904673	1

Accessories

Resistance circuits

Double-level terminal block with resistance circuit in accordance with NAMUR for line fault detection in the case of mechanical contacts

Important:

- For intrinsically safe circuits, only in combination with D-UKK 3/5 cover



		Ordering data		
Description	Color	Type	Order No.	Pcs./Pkt.
Double-level terminal block , with preassembled resistors				
with screw connection	gray	UKK 5-2R/NAMUR	2941662	50
Cover , width 2.5 mm	gray	D-UKK 3/5	2770024	50
	blue	D-UKK 3/5 BU	2770105	50

Accessories

Test plugs



		Ordering data		
Description	Color	Type	Order No.	Pcs./Pkt.
Test plug , consisting of:				
Metal part for 2.3 mm Ø socket hole and	gray	MPS-MT	0201744	10
Insulating sleeve , for MPS metal part	red	MPS-IH RD	0201676	10
	black	MPS-IH BK	0201731	10
	gray	MPS-IH GY	0201728	10
	green	MPS-IH GN	0201702	10
	yellow	MPS-IH YE	0201692	10
	blue	MPS-IH BU	0201689	10
	white	MPS-IH WH	0201663	10

Accessories

Marking material for device marking

- For device marking inside the control cabinet and in the field
- Self-adhesive with high adhesive strengths
- Large temperature range



		Ordering data		
Description	Color	Type	Order No.	Pcs./Pkt.
UniCard , with self-adhesive plastic labels				
10-part, lettering field size: 11 x 9 mm	white	UC-EMLP (11X9)	0819291	10
UniCard , with self-adhesive plastic labels, marked in accordance with customer specifications For ordering details, see Catalog 3 or phoenixcontact.net/product.				
10-part, lettering field size: 11 x 9 mm	white	UC-EMLP (11X9) CUS	0824547	1





The Field Analog process indicators allow you to monitor and display analog and temperature signals as well as control them via digital and analog inputs and outputs.

Further advantages:

- 2-conductor sensors are powered by the integrated measuring transducer supply
- International use, thanks to UL and CSA approvals



Universal use

Field Analog process indicators are available for field and control panel installation. The universal inputs allow you to record current, voltage, RTDs, and TCs.



Everything at a glance

Real-time process values are easy to read on the five-digit backlit displays. The bar graph also provides you with a quick overview. You can recognize alarm statuses easily from a distance by their changing color.



Easy installation and startup

Thanks to the standardized housing dimensions and plug-in connection terminal blocks, the indicators are easy to install. The devices are easy to configure via the keyboard on the front or via FDT/DTM software.



Intrinsic safety zone 0, zone 20

Also for intrinsically safe circuits in the Ex area: versions with ATEX, CSA, and FM approval.



Distributed control cabinet installation

Measurement and control temperature transducer for resistance thermometers, thermocouples, resistance-type sensors, and voltage sensors are also available for control cabinet installation.



Head-mounted transducer

With head-mounted transducers you can record temperatures directly in the field and convert them into standard signals.

Multifunctional process indicators

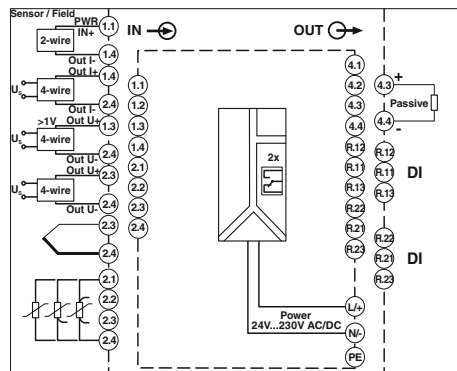
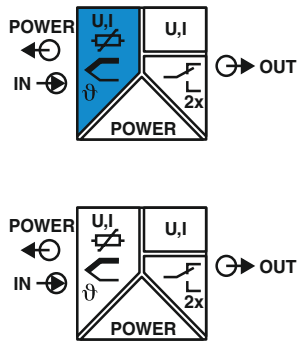

Block diagram FA-MCR-D-TUI-UI-2REL-UP



Multifunctional process indicator for installation in the control cabinet



Housing width 96 mm

For installation in the control cabinet

- Multifunctional process indicator, in control panel component housing for monitoring and displaying analog measurement data
- Supply of 2-conductor sensors
- Safe 4-way isolation
- Configurable via software or hardware keyboard on the front
- Universal inputs for connection of current, voltage, RTDs, and TCs
- Limit value monitoring with two relay outputs
- Process signal transmission via analog output
- Display changes color in the event of an error

Notes:
The configuration software can be downloaded from the Internet (phoenixcontact.net/products).

Input data	Input signal
Input data	Sensor types that can be used
	Connection method
	Measuring rate
	Temperature measuring range
Input resistance	
Output data	Output signal
Display	
Number of the displayed positions	
Switching output	
Number of outputs	
Switching output	Contact type
	Max. switching voltage
	Maximum switching current
	Minimum switching current
General data	Supply voltage range
	Degree of protection
	Ambient temperature (operation)
	Housing material
	Dimensions W/H/D
	Control panel cutout
	Screw connection rigid / flexible / AWG
Conformance/approvals	Conformance
	ATEX
	UL, USA/Canada
	FM approval
	CSA
	GL

Technical data	
U input	I input
0 V ... 10 V	0 mA ... 20 mA +10%
2 V ... 10 V	4 mA ... 20 mA +10%
0 V ... 5 V	
0 V ... 1 V	
1 V ... 5 V	
-1 V ... 1 V	
-10 V ... 10 V	
-30 V ... 30 V	
-100 mV ... 100 mV	
RTD	TC
Pt, Ni, Cu sensors	J, K, T, N, B, S, R, U, L, C, D
2-, 3-, 4-conductor	-
200 ms	200 ms
-200°C ... 1,100°C	-200°C ... 2,495°C
(range depends on sensor type, adjustable)	(range depends on sensor type, adjustable)
-	10 Ω
U output	I output
0 V ... 10 V	0 mA ... 20 mA
2 V ... 10 V	4 mA ... 20 mA
0 V ... 5 V	
1 V ... 5 V	
7-segment LC display, with backlight, dot matrix for text/bar graph	
5	
Transistor output, active	
Open collector output	
1	
Relay output	
2 PDT	
30 V DC (3 A) / 230 V AC (3 A)	
3 A	
10 mA	
24 V DC ... 230 V DC	
IP65 from the front	
-20°C ... 60°C	
PC-GF10	
96 / 48 / 151.8 mm	
92 x 45 mm	
0.14 ... 1.5 mm ² / 0.14 ... 1.5 mm ² / 26 - 16	
FA MCR-D-TUI-UI-2REL-UP	FA MCR-EX-D-TUI-UI-2REL-UP
CE-compliant	CE-compliant
-	Ex II (1) G [Ex ia Ga] IIC
UL 61010 Recognized	UL 61010 Recognized
-	AIS, NI/1/2/ABCDEF/T4
CSA GP	AIS, NI/1/2/ABCDEF/T4
GL EMC 1 C	EMC 1 C

Description
Programming adapter for configuring modules with T-PORT interface
DIN rail adapters for displays

Ordering data		
Type	Order No.	Pcs./Pkt.
FA MCR-EX-D-TUI-UI-2REL-UP	2907216	1
FA MCR-D-TUI-UI-2REL-UP	2907064	1

Accessories		
Type	Order No.	Pcs./Pkt.
MCR-PAC-T-USB	2309000	1
FA MCR-D-RM	1032996	1

Multifunctional process indicators

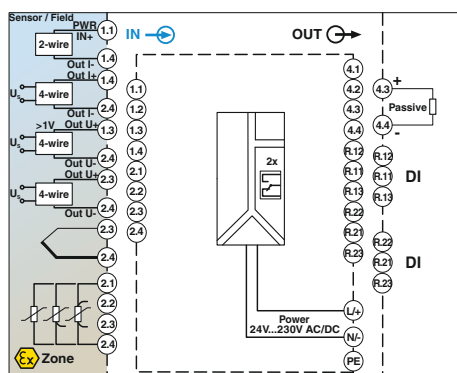
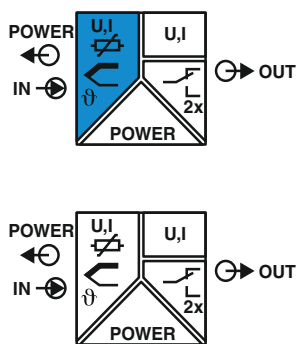

Block diagram FA MCR-EX-FD-TUI-UI-2REL-UP



Ex: Housing width 199 mm

Field housing

- Multifunctional process indicator, in control panel component housing for monitoring and displaying analog measurement data
- Supply of 2-conductor sensors
- Safe 4-way isolation
- Configurable via software or hardware keyboard on the front
- Universal inputs for connection of current, voltage, RTDs, and TCs
- Limit value monitoring with two relay outputs
- Process signal transmission via analog output
- Display changes color in the event of an error

Technical data	
Input data	
Input signal	U input I input
	0 V ... 10 V 0 mA ... 20 mA +10%
	2 V ... 10 V - 4 mA ... 20 mA +10%
	0 V ... 5 V
	0 V ... 1 V
	1 V ... 5 V
	-1 V ... 1 V
	-10 V ... 10 V
	-30 V ... 30 V
	-100 mV ... 100 mV
	RTD TC
	Pt, Ni, Cu sensors J, K, T, N, B, S, R, U, L, C, D
	2-, 3-, 4-conductor -
	200 ms 200 ms
	-200°C ... 1,100°C -200°C ... 2,495°C
	(range depends on sensor type, adjustable) (range depends on sensor type, adjustable)
	- 10 Ω
Output data	
Output signal	U output I output
	0 V ... 10 V 0 mA ... 20 mA
	2 V ... 10 V 4 mA ... 20 mA
	0 V ... 5 V
	1 V ... 5 V
	7-segment LC display, with backlight, dot matrix for text/bar graph
Display	
Number of the displayed positions	5
Switching output	
	Transistor output, active
	Open collector output
	1
Relay output	
	2 PDT
	30 V DC (3 A) / 230 V AC (3 A)
	3 A
	10 mA
General data	
Supply voltage range	24 V DC ... 230 V DC
Degree of protection	IP67
Ambient temperature (operation)	-40°C ... 50°C (The readability of the display is no longer guaranteed at temperatures below -30°C (-22°F).)
Housing material	
Dimensions W/H/D	PBT GF30
Screw connection rigid / flexible / AWG	199 / 160 / 96 mm
	0.2 ... 2.5 mm ² / 0.2 ... 2.5 mm ² / 24 - 14
Conformance/approvals	
Conformance	FA MCR-EX-FD-TUI-UI-2REL-UP FA MCR-FD-TUI-UI-2REL-UP
ATEX	CE-compliant CE-compliant
UL, USA/Canada	Ex II (1) G [Ex ia Ga] IIC -
FM approval	UL 61010 Recognized UL 61010 Recognized
CSA	AIS / I / 1 / ABCDEFG -
	Associated Apparatus CSA GP

Ordering data		
Type	Order No.	Pcs./Pkt.
FA MCR-EX-FD-TUI-UI-2REL-UP	2907781	1
FA MCR-FD-TUI-UI-2REL-UP	2907780	1

Accessories		
Accessories	Order No.	Pcs./Pkt.
Programming adapter for configuring modules with T-PORT interface	2309000	1
Pipe or wall mounting set, for use with multi-functional process indicator in field housing	2908739	1

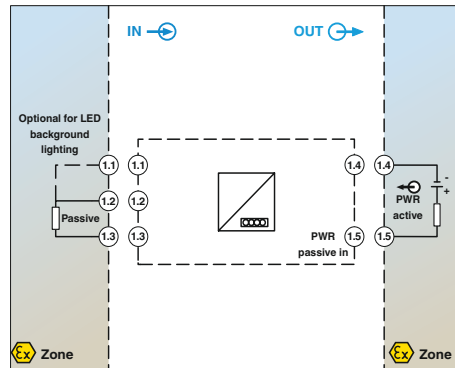
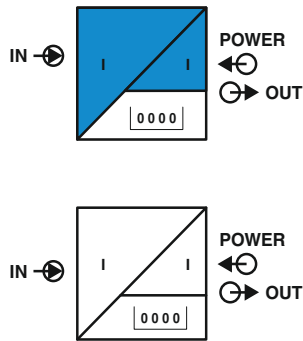

Block diagram FA MCR-EX-DS-I-OLP



Loop-powered process indicator with HART communication for installation in the control cabinet

Ex: Ex, Ex
Housing width 96 mm

For installation in the control cabinet

- Loop-powered
- Display of 4 to 20 mA or HART signals
- Low voltage drop
- 5-digit 7-segment display
- Display value can be scaled
- Low installation depth
- Configurable via front keyboard
- SIL-impact-free in accordance with EN61508
- Can be installed in zone 1

Input data	
Input signal	I
Maximum input signal	200 mA
Voltage drop	≤1 V
Input impedance	Approx. 50 Ω
Output data	
Display	7-segment LC display, with backlight, dot matrix for text/bar graph
Number of the displayed positions	5
General data	
Supply voltage range	Loop-powered, no external supply necessary
Resolution A/D	>13 bit
Degree of protection	IP65 (front) IP20 (on the rear)
Ambient temperature (operation)	-40°C ... 60°C
Housing material	Aluminum / polycarbonate
Dimensions W/H/D	96 / 48 / 41.5 mm
Control panel cutout	92 x 45 mm
Screw connection rigid / flexible / AWG	0.14 ... 1.5 mm ² / 0.14 ... 1.5 mm ² / 26 - 16
Conformance/approvals	
Conformance	CE-compliant
ATEX	Ex II 2G Ex ib IIC T6 Gb
UL, USA/Canada	UL 61010 Listed
FM approval	-
CSA	-

Technical data	
I	HART
4 mA ... 20 mA	up to 4x HART signals
200 mA	-
≤1 V	≤1.9 V
≤3.9 V (with display lighting)	≤4.8 V (with display lighting)
Approx. 50 Ω	R _x = 40 Ω / C _x = 2.3 nF
7-segment LC display, with backlight, dot matrix for text/bar graph	
5	
Loop-powered, no external supply necessary	
>13 bit	
IP65 (front) IP20 (on the rear)	
-40°C ... 60°C	
Aluminum / polycarbonate	
96 / 48 / 41.5 mm	
92 x 45 mm	
0.14 ... 1.5 mm ² / 0.14 ... 1.5 mm ² / 26 - 16	
CE-compliant	CE-compliant
Ex II 2G Ex ib IIC T6 Gb	-
UL 61010 Listed	UL 61010 Listed
-	-
-	-

Description
Output loop-powered process indicator inside the control panel housing for representing current or HART signals

Ordering data		
Type	Order No.	Pcs./Pkt.
FA MCR-EX-DS-I-I-OLP	2908800	1
FA MCR-DS-I-I-OLP	2908781	1

DIN rail adapters for displays

Accessories		
Type	Order No.	Pcs./Pkt.
FA MCR-D-RM	1032996	1

new

Loop-powered process indicators

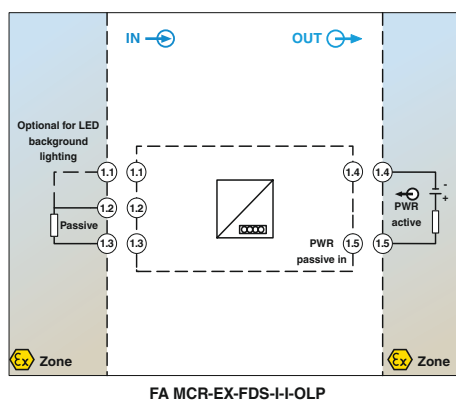
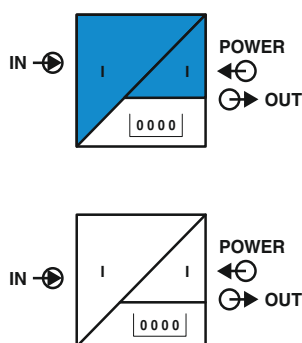

Ex Zone
Ex: Ex, Ex
Housing width 131 mm

Field housing

- Loop-powered
- Display of 4 to 20 mA or HART signals
- Low voltage drop
- 5-digit 7-segment display
- Display value can be scaled
- Low installation depth
- Configurable via front keyboard
- SIL-impact-free in accordance with EN61508
- Can be installed in zone 1

Technical data	
Input data	I HART
Input signal	4 mA ... 20 mA up to 4x HART signals
Maximum input signal	200 mA -
Voltage drop	≤1 V ≤1.9 V
	≤3.9 V (with display lighting) ≤4.8 V (with display lighting)
Input impedance	Approx. 50 Ω R _x = 40 Ω / C _x = 2.3 nF
Output data	
Display	7-segment LC display, with backlight, dot matrix for text/bar graph
Number of the displayed positions	5
General data	
Supply voltage range	Loop-powered, no external supply necessary
Resolution A/D	>13 bit
Degree of protection	IP66/IP67 NEMA 4X
Ambient temperature (operation)	-40°C ... 60°C
Housing material	Aluminum
Dimensions W/H/D	131 / 81.5 / 55.5 mm
Screw connection rigid / flexible / AWG	0.14 ... 1.5 mm ² / 0.14 ... 1.5 mm ² / 26 - 16
Conformance/approvals	
Conformance	CE-compliant CE-compliant
ATEX	Ex II 2G Ex ib IIC T6 Gb -
UL, USA/Canada	UL 61010 Listed UL 61010 Listed
FM approval	-
CSA	-

Description
Output loop-powered process indicator inside field housing for representing current or HART signals
Pipe or wall mounting set , for use with output loop-powered process indicator in field housing

Ordering data		
Type	Order No.	Pcs./Pkt.
FA MCR-EX-FDS-I-I-OLP	2908801	1
FA MCR-FDS-I-I-OLP	2908782	1
Accessories		
FA MCR-FDS-PM	2908783	1

Displays
Standard signals

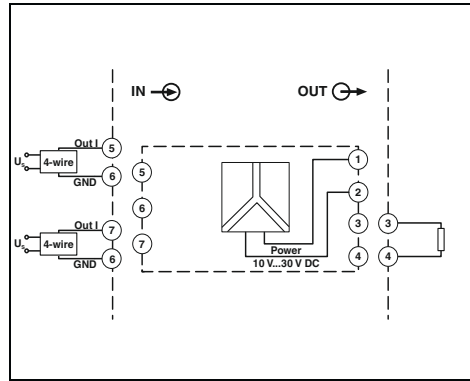
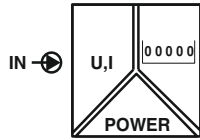

Block diagram MCR-SL-S-U-I



For analog standard signals, configurable

For installation in the control cabinet

- For 0 to 10 V and 0(4) to 20 mA standard analog signals
- Configurable
- 5 positions displayed
- 8 mm LED, 7-segment
- Galvanically isolated
- Minimum/maximum value storage
- Latch/hold function for storing the display value
- Display 48 x 24 mm
- Totalizing counter

Input data	
Input signal	
Maximum input signal	
Input resistance	
Resolution	
Measuring rate	
Input latch signal	
Switching level	1 signal ("H") 0 signal ("L")
Output data	
Display	
Number of the displayed positions	
Accuracy	
General data	
Supply voltage range	
Current consumption	
Mass storage	
Resolution A/D	
System hum suppression	
Test voltage input/power supply	
Degree of protection	
Ambient temperature (operation)	
Housing material	
Dimensions W/H/D	
Control panel cutout	
Screw connection rigid / flexible / AWG	
Conformance/approvals	
Conformance	
UL, USA/Canada	

ERIE
Housing width 48 mm

Technical data	
U input	I input
0 ... 10 V / 2 ... 10 V	0 ... 20 mA / 4 ... 20 mA
30 V DC	50 mA
>1 MΩ	Approx. 100 Ω with 5 mA / approx. 70 Ω with 20 mA
1 mV	2 μA
0.1s ⁻¹ / 0.5s ⁻¹	
Display stop	
4 V DC ... 30 V DC	
0 V DC ... 2 V DC	
7-segment LED; 8 mm; red	
5	
<0.1% ±1 digit (at an ambient temperature of 20°C)	
10 V DC ... 30 V DC	
50 mA	
EEPROM 1 mil. memory cycles or 10 years	
14 bit	
Digital filtering 50/60 Hz	
500 V _{rms} (50/60 Hz, 1 min.)	
IP65 from the front	
-20°C ... 65°C	
Macrolon 2405	
48 / 24 / 68 mm	
22(+0.6)x45(+0.8) mm	
0.14 ... 1.5 mm ² / 0.14 ... 1.5 mm ² / 26 - 16	
CE-compliant	
UL 863	

Description
MCR process display, for measuring and displaying standard signals
MCR DIN rail adapter for digital displays in a 24 x 48 mm housing

Ordering data		
Type	Order No.	Pcs./Pkt.
MCR-SL-D-U-I	2864011	1
Accessories		
MCR-SL-D-RA	2810081	1

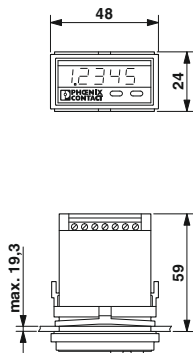

Displays
Frequency

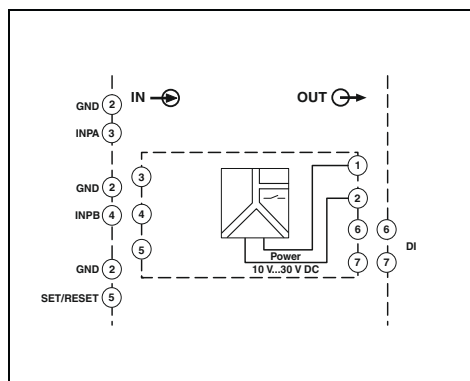
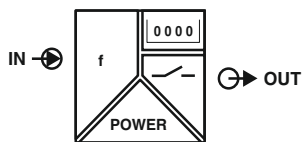

Block diagram MCR-SL-D-FIT



Programmable digital display for frequencies, pulses and times

For installation in the control cabinet

- For frequency signals up to max. 60 kHz
- Configurable
- 6 positions displayed
- LED 8 mm, 7 segment
- 48 x 24 mm display

Input data	
Maximum input signal	60 kHz
Input resistance	10 kΩ
Switching level	1 signal ("H") 0 signal ("L")
Output data	
Display	7-segment LED; 8 mm; red
Number of the displayed positions	6
Switching output	
Max. switching voltage	30 V DC
Maximum switching current	10 mA
General data	
Supply voltage range	10 V DC ... 30 V DC
Current consumption	max. 40 mA
Mass storage	EEPROM 1 mil. memory cycles or 10 years
Degree of protection	IP65 from the front
Ambient temperature (operation)	-20°C ... 65°C
Housing material	Macrolon 2405
Dimensions W/H/D	48 / 24 / 68 mm
Control panel cutout	22(+0.6)x45(+0.8) mm
Screw connection rigid / flexible / AWG	0.14 ... 1 mm ² / 0.14 ... 1.5 mm ² / 26 - 16
Conformance/approvals	
Conformance	CE-compliant
UL, USA/Canada	UL 863



Housing width 48 mm

Technical data

Technical data	
Maximum input signal	60 kHz
Input resistance	10 kΩ
Switching level	1 signal ("H") 0 signal ("L")
Output data	
Display	7-segment LED; 8 mm; red
Number of the displayed positions	6
Switching output	
Max. switching voltage	30 V DC
Maximum switching current	10 mA
General data	
Supply voltage range	10 V DC ... 30 V DC
Current consumption	max. 40 mA
Mass storage	EEPROM 1 mil. memory cycles or 10 years
Degree of protection	IP65 from the front
Ambient temperature (operation)	-20°C ... 65°C
Housing material	Macrolon 2405
Dimensions W/H/D	48 / 24 / 68 mm
Control panel cutout	22(+0.6)x45(+0.8) mm
Screw connection rigid / flexible / AWG	0.14 ... 1 mm ² / 0.14 ... 1.5 mm ² / 26 - 16
Conformance/approvals	
Conformance	CE-compliant
UL, USA/Canada	UL 863

Description
MCR digital display , for measurement and display of frequencies, pulses and times

MCR DIN rail adapter for digital displays in a 24 x 48 mm housing

Ordering data

Type	Order No.	Pcs./Pkt.
MCR-SL-D-FIT	2864024	1

Accessories

MCR-SL-D-RA	2810081	1
-------------	---------	---

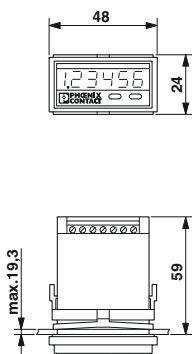

Displays
Setpoint adjusters

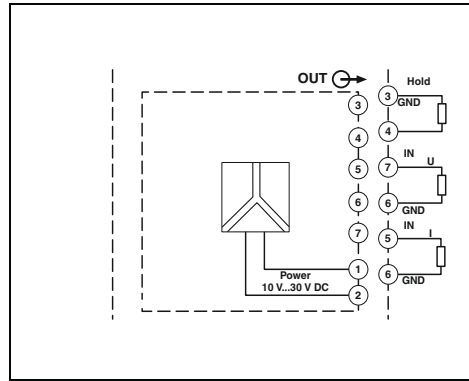
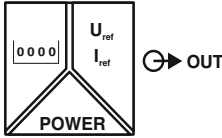

Block diagram MCR-SL-D-SPA-UI



With manual and automatic ramp function

For installation in the control cabinet

- Manual setpoint definition with step width setting
- Manual setpoint definition via direct input
- Automatic setpoint definition with hold function and 20 support points
- Flexible, adjustable signal ranges of 0 to 12 V or 0 to 24 mA
- Data backup in case of a power failure
- Display value configuration
- Electrical isolation between output and supply

Input data	
Display	7-segment, 8 mm, red
Number of the displayed positions	4
Switching level	1 signal ("H") 0 signal ("L")
Output data	
Output signal	U output 0 ... 12 V
Length of step	10 mV
Load R _B	≥2 kΩ
Ripple	
≤10 mV _{pp}	
General data	
Supply voltage range	10 V DC ... 30 V DC
Power consumption	1 W (with 24 mA/12 V)
Maximum transmission error	<0.2% ((full-scale) at rated voltage)
Test voltage output/power supply	500 V AC (50 Hz, 1 min.)
Degree of protection	IP65 from the front
Ambient temperature (operation)	-20°C ... 65°C
Housing material	Macrolon 2405
Dimensions W/H/D	48 / 24 / 68 mm
Control panel cutout	45(+0.6)x22.2(+0.3) mm
Screw connection rigid / flexible / AWG	0.14 ... 1.5 mm ² / 0.14 ... 1.5 mm ² / 26 - 16
Conformance/approvals	
Conformance	CE-compliant
UL, USA/Canada	UL 863

ERIE
Housing width 48 mm

Technical data

U output	I output
0 ... 12 V	0 ... 24 mA
10 mV	10 μA
≥2 kΩ	≤500 Ω (up to 20 mA)
	≤400 Ω (>20 mA)

Description	MCR digital setpoint encoder , for presetting current and voltage signals	
-------------	--	--

Ordering data		
Type	Order No.	Pcs./Pkt.
MCR-SL-D-SPA-UI	2710314	1

Description	MCR DIN rail adapter for digital displays in a 24 x 48 mm housing	
-------------	--	--

Accessories		
Type	Order No.	Pcs./Pkt.
MCR-SL-D-RA	2810081	1

Temperature, temperature head-mounted transducers

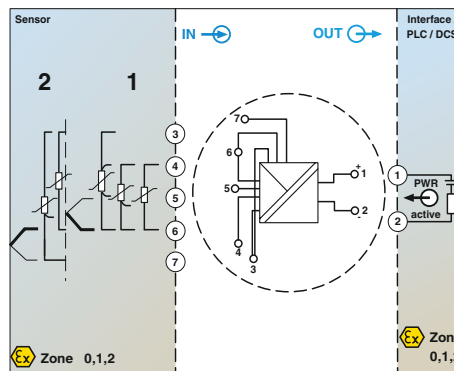
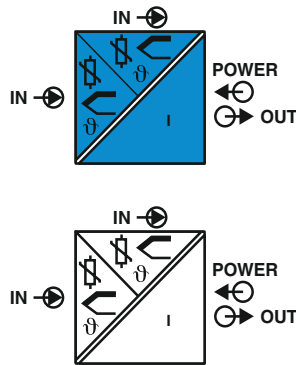

Loop-powered temperature head-mounted transducer



- Output loop-powered temperature head-mounted transducers
- 2 universal inputs for RTD, TC, resistance-type sensors and voltage sensors (mV), Ex ia IIC
- 4 to 20 mA output
- HART communication
- Freely configurable
- SIL 2/3
- For mounting in the connecting head, form B
- Can be installed in zone 0

Input data	
Resistance thermometers	
Thermocouple sensors	
Resistor	
Input voltage range	
Output data	
Output signal	
Maximum output signal	
Load R _B	
Switch-on delay	
General data	
Supply voltage range	
Current consumption	
Step response (0 - 99%)	
Electrical isolation	
Degree of protection	Input/output
Ambient temperature (operation)	
Screw connection rigid / flexible / AWG	
Conformance/approvals	
Conformance	
ATEX	
UL, USA/Canada	
FM approval	
CSA	

Technical data	
Pt, Ni, Cu sensors: 2-, 3-, 4-conductor: -	
A, B, C, D, E, J, K, L, N, R, S, T, U	
10 Ω ... 2,000 Ω (minimum measuring span: 10 Ω)	
-20 mV ... 100 mV	
4 ... 20 mA, HART / 20 ... 4 mA	
23 mA	
(U _L - 11 V) / 0.023 A	
Approx. 10 s (HART)	
Approx. 28 s (measured value)	
11 V DC ... 42 V DC	
23.5 mA	
0.8 s (TC)	
2 kV AC	
IP33 (upon installation in field housing IP66/67, NEMA 4X)	
-40°C ... 85°C	
0.2 ... 1.5 mm ² / 0.2 ... 1.5 mm ² / 24 - 16	
CE-compliant	CE-compliant
Ex II 1G Ex ia IIC T6...T4 Ga	Ex II 3G Ex nA IIC T6...T4 Gc
UL 61010 Recognized	UL 61010 Recognized
NI / Class I / Div. 1, 2 / Group ABCD T6/T5/T4	NI / Class I / Div. 1, 2 / Group ABCD T6/T5/T4
Exia / Class I / Group ABCD T6/T5/T4	NI, Class I, Div. 2, Groups A, B, C, D

Description
Output loop-powered temperature transducer, for RTD, TC, resistance-type sensors and voltage sensors (mV)
Programming adapter for configuring modules with T-PORT interface
Display unit for plugging directly into the FA MCR-... head-mounted transducer
Adapter for control cabinet installation of head-mounted transducers
Field housing for head-mounted transducers, with display window and two cable entries
Wall fastening for FA MCR-HT-FH field housing
Adapter cable, 1 m long, with USB connection, for HART configuration

Ordering data		
Type	Order No.	Pcs./Pkt.
FA MCR-EX-HT-TS-I-OLP-PT	2908743	1
FA MCR-HT-TS-I-OLP-PT	2908742	1

Accessories		
MCR-PAC-T-USB	2309000	1
FA MCR-HT-D	2908735	1
MCR-DIN-RAIL-ADAPTER HT	2864671	1
FA MCR-HT-FH	2908736	1
FA MCR-HT-FH-WM	2908737	1
GW HART USB MODEM	1003824	1

Temperature, temperature transducers

new

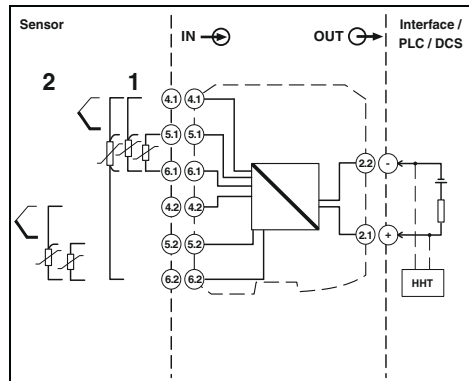
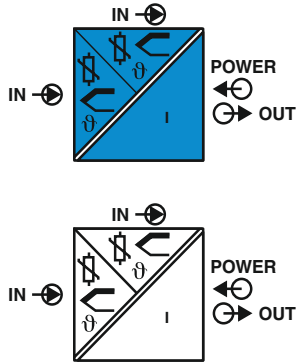

SIL IEC 61508



Output loop-powered temperature transducer

Functional Safety
 Ex: IECEx
 Housing width 12.5 mm

- Loop-powered temperature transducer
- 2 universal inputs for RTD, TC, resistance-type sensors and voltage sensors (mV), Ex ia IIC
- 4 to 20 mA output
- HART communication
- Freely configurable
- SIL 2/3
- For DIN rail mounting
- Can be installed in zone 0

Input data	
Input signal (can be configured using DIP switches)	
Input signal (can be configured using DIP switches)	
Temperature range	
Linear resistance measuring range	
Input voltage range	
Output data	
Output signal	
Maximum output signal	
Load R_B	
General data	
Supply voltage range	
Current consumption	
Step response (0 - 99%)	
Electrical isolation of input/output	
Ambient temperature (operation)	
Altitude	
Dimensions W/H/D	
Push-in connection rigid / flexible / AWG	
Screw connection rigid / flexible / AWG	
Conformance/approvals	
Conformance	
ATEX	
UL, USA/Canada	
FM approval	
CSA	

Technical data	
Pt, Ni, Cu sensors: 2-, 3-, 4-conductor: -	
A, B, C, D, E, J, K, L, N, R, S, T, U	
-250°C ... 2,500°C (range depending on the sensor type)	
10 Ω ... 2,000 Ω (minimum measuring span: 10 Ω)	
-20 mV ... 100 mV	
4 ... 20 mA / 20 ... 4 mA	
23 mA	
$(U_L - 11 V) / 0.023 A$	
12 V DC ... 42 V DC	
≤23 mA	
0.8 s (TC)	
2 kV AC	
-40°C ... 85°C	
≤4,000 m (above sea level)	
12.5 / 99 / 114.5 mm	
0.2 ... 1.5 mm ² / 0.2 ... 1.5 mm ² / 24 - 16	
0.2 ... 2.5 mm ² / 0.2 ... 2.5 mm ² / 24 - 14	
CE-compliant	CE-compliant
II 3G Ex nA IIC T6...T4 Gc	II 3G Ex nA IIC T6...T4 Gc
UL 61010 Recognized	UL 61010 Recognized
NI, Class I, Div. 2, Groups A, B, C, D	NI, Class I, Div. 2, Groups A, B, C, D
NI / Class I / Div. 2 / ABCD T6/T5/T4	NI / Class I / Div. 2 / ABCD T6/T5/T4

Description	
Output loop-powered temperature transducer, for RTD, TC, resistance-type sensors and voltage sensors (mV)	
Screw connection	MACX MCR-TS-I-OLP
Push-in connection	MACX MCR-TS-I-OLP-SP
Screw connection	MACX MCR-TS-I-OLP-C
Screw connection	MACX MCR-EX-TS-I-OLP
Push-in connection	MACX MCR-EX-TS-I-OLP-SP

Ordering data		
Type	Order No.	Pcs./Pkt.
MACX MCR-TS-I-OLP	2908662	1
MACX MCR-TS-I-OLP-SP	2908664	1
MACX MCR-TS-I-OLP-C	1012249	1
MACX MCR-EX-TS-I-OLP	2908660	1
MACX MCR-EX-TS-I-OLP-SP	2908661	1

Programming adapter for configuring modules with T-PORT interface	

Accessories		
Type	Order No.	Pcs./Pkt.
MCR-PAC-T-USB	2309000	1

Order key for MACX MCR-TS-I-OLP-C output loop-powered temperature transducers (standard configuration entered as an example)

Order No.	Safety Integrity Level	Input		Sensor type	Connection technology	Measuring range		Error	Output
		Measuring unit				Start	End		
1012249	ON	C	PT100	3	-200	850	MIN	3.58	
1012249 ≙ MACX MCR- TS-I-OLP-C	ON ≙ SIL ON OFF ≙ SIL OFF	C ≙ Celsius F ≙ Fahrenheit O ≙ Ω V ≙ Millivolts K ≙ Kelvin R ≙ Rankine	PT100 ≙ PT100 IEC 751 PT200 ≙ PT200 IEC 751 PT500 ≙ PT500 IEC 751 PT1000 ≙ PT1000 IEC 751 PT100J ≙ PT100 JIS C1604 NI100 ≙ NI100 DIN 43760 NI120 ≙ NI120 DIN 43760 NI100G ≙ NI100 OIML/GOST 6651-09 NI120G ≙ NI120 OIML/GOST 6651-09 PT50G ≙ PT50 G GOST 6651 (α=0.00391) PT100G ≙ PT100 G GOST 6651 (α=0.00391) CU50 ≙ CU 50 GOST (α=0.00428) CU50G ≙ CU 50 GOST (α=0.00426) CU100 ≙ CU 100 GOST (α=0.00428) A1G ≙ A-1 GOST 8.585-2001 B ≙ B IEC584-1 (Pt30Rh-Pt6Rh) C ≙ C ASTM E988 DA ≙ DA ASTM E988(2002) E ≙ E IEC584-1 (NiCr-CuNi) J ≙ J IEC584-1 (Fe-CuNi) K ≙ K IEC584-1 (NiCr-Ni) N ≙ N IEC 584-1 (NiCrSi-NiSi) R ≙ R IEC 584-1 (Pt13Rh-Pt) S ≙ S IEC 584-1 (Pt10Rh-Pt) T ≙ T IEC 584-1 (Cu-CuNi) L ≙ L DIN 43760 (Fe-CuNi) LG ≙ LG GOST 8.585-2001 U ≙ U DIN 43760 (Cu-CuNi) RES13 ≙ PT100 IEC751 RES14 ≙ PT100 IEC751 V11 ≙ PT100 IEC751	2 ≙ 2-conductor 3 ≙ 3-conductor 4 ≙ 4-conductor	Freely selectable between -250°C ... 2,500°C (measuring range limits depend on sensor type)	Freely selectable between -250°C ... 2,500°C (measuring range limits depend on sensor type)	MIN ≙ 3.58 mA MAX ≙ freely selectable between 21.5...23 mA	3.58 ≙ 3.58 mA Freely selectable between 21.5 ... 23 mA	

Measurement range signal span of at least 10°K for RTD sensors/50°K for TC sensors

Field Analog accessories

Accessories for head-mounted transducers

- 2 cable entries
- Aluminum with polyester coating
- For use with head-mounted transducers
- Display window in cover



Field housing for head-mounted transducers

General data	
Housing material	Aluminum
Description	
Field housing for head-mounted transducers, with display window and two cable entries	
Wall fastening for FA MCR-HT-FH field housing	
Pipe fastening for FA MCR-HT-FH field housing	

Technical data		
Aluminum		
Ordering data		
Type	Order No.	Pcs./Pkt.
FA MCR-HT-FH	2908736	1
Accessories		
FA MCR-HT-FH-WM	2908737	1
FA MCR-HT-FH-PM	2908738	1

Accessories for head-mounted transducers

- For snapping onto the DIN rail
- For control cabinet installation of head-mounted transducers
- Display unit for plugging directly into FA MCR-... head-mounted transducers
- Separately configurable
- Direct process value readout



Display unit for plugging directly into head-mounted transducers



Adapter for DIN rail mounting of head-mounted transducers

Ordering data			
Description	Type	Order No.	Pcs./Pkt.
Display unit for plugging directly into the FA MCR-... head-mounted transducer	FA MCR-HT-D	2908735	1
Adapter for control cabinet installation of head-mounted transducers			

Ordering data		
Type	Order No.	Pcs./Pkt.
MCR-DIN-RAIL-ADAPTER HT	2864671	1

Accessories for displays

new

new

- HART® communication resistor, 250 Ω, in combination with digital display FA MCR-(EX)-(F)DS-I-I-OLP
 - DIN rail adapter for mounting on a 35 mm DIN rail in combination with digital display FA MCR-(EX)-D-TUI-UI-2REL-UP, FA MCR-(EX)-(F)DS-I-I-OLP
- See web site for more.



HART communication resistor



DIN rail adapter for displays

Ordering data

Ordering data

Description
HART communication resistor
DIN rail adapters for displays

Type	Order No.	Pcs./Pkt.
FA MCR-FDS-R250	2908802	1

Type	Order No.	Pcs./Pkt.
FA MCR-D-RM	1032996	1

Accessories

Programming adapters

- Programming adapters with USB and T port interface, 2.4 m for programming FA MCR-..., MCR-...-LP-..., and MCR-...-HT-... modules
- HART USB modem for configuring MACX MCR-TS-I-OLP-..., MACX MCR-EX-TS-I-OLP-..., FA MCR-HT-TS-I-OLP-... and FA MCR-EX-HT-TS-I-OLP-... using the HART protocol



Programming adapter



HART USB MODEM

Ordering data

Ordering data

Description
Programming adapter for configuring modules with T-PORT interface
HART USB modem, for configuring modules with HART communication

Type	Order No.	Pcs./Pkt.
MCR-PAC-T-USB	2309000	1

Type	Order No.	Pcs./Pkt.
GW HART USB MODEM	1003824	1



Monitoring

Your fastest route to energy measurement

The EMpro energy measuring devices can be configured and integrated into the network within minutes. Reduce your wiring and configuration effort and benefit from smart web server functions.

Convert and measure currents

For a new installation or for retrofitting: Our PACT current transformers offer a comprehensive product range for converting high alternating currents into low secondary currents. Current and voltage transducers convert currents or voltages into a standard analog signal.

Utilize solar electricity efficiently

SOLARCHECK PV string monitoring gives you reliable information about your photovoltaic system's power.

For high system availability

EMD monitoring relays can be used to detect deviations in important system parameters at an early stage. These can be indicated or system parts can be shut down selectively. EMD monitoring relays ensure error-free and cost-effective operation of your system. They are an inexpensive solution for numerous monitoring functions.

Perfect timing

ETD timer relays from Phoenix Contact are the cost-effective alternative to a PLC for easy time control.

Fast error detection

EMG display modules simplify troubleshooting and provide help for monitoring control processes. EMG lamp testing modules can be used to test lamps individually or centrally.

Protection and decoupling

Protect your system against polarity reversal and decouple messages in the fault reporting system with EMG diode modules.

Product range overview

Product overview	196
Measuring power and energy	198
EMpro energy meters	202
MID energy meters	204
Software for usage data acquisition	206
Complete packages for data logging	207
Current measurement	
Current transformers	208
Current transformer selection guide	210
PACT current transformers	211
Accessories for PACT current transformers	218
Current transformers for retrofitting PACT RCP	220
Current transducers	228
Accessories for current transducers	239
Monitoring and diagnostics	
Solar system monitoring	240
EMD electronic monitoring relays	244
ETD electronic timer relays	256
Diode modules, lamp testing modules, EMG display modules	266

Monitoring

Product overview

Measuring power and energy



EMpro energy meters for front-panel installation
Page 202



EMpro energy meters for DIN rail mounting
Page 203



EMpro energy measuring devices without display for DIN rail mounting
Page 203



Three-phase energy meters
Page 204

Current transformers



PACT bus-bar current transformers
Page 211



PACT window-type current transformers
Page 212



PACT winding current transformers
Page 217



Mounting accessories, shock protection
Page 218

Voltage measurement



MCR current protectors for AC currents, sinusoidal up to 16 A
Page 237



MCR voltage transducers for AC- and DC voltages up to 660 V
Page 238



Accessories
Configuration software and USB adapter cable
Page 239

Solar system monitoring



SOLARCHECK
Photovoltaic string monitoring
Page 240

Monitoring relays



EMD-BL
Compact monitoring relays
Page 246

Timer relays



ETD-BL
Ultra-narrow timer relays
Page 260



Ultra-narrow multifunctional timer relays
Page 262



ETD
Multifunctional timer relays
Page 264



Software for usage data acquisition
Page 206



Complete packages for data logging
Page 207



PACT RCP.. current transformers
for retrofitting
Page 222



PACT-RCP...-UV current transformers
for retrofitting with UV protection
Page 224

Current measurement



MCR current transducers for AC/DC and
distorted currents
Page 228



MCR current transducers for sinusoidal and
distorted AC currents
Passive, up to 5 A
Page 234
Page 236

Special function modules



EMG
Diode modules, lamp testing modules,
display modules
Page 266



Always the right product

Whether it's complex energy measurement or easy cost center billing, the wide range of multifunctional energy measuring device and MID-certified energy meter products available can cover every application. In addition, a large selection of current transformers is also available, including for retrofits. All products meet high demands for convenient installation.

Uniquely convenient handling

Set up the communications interface, select the power network type, configure the measuring input: the EMpro energy measuring devices can be configured and integrated into the network in minutes. Save on wiring and configuration effort thanks to direct connection of manufacturer-independent current sensors. Digital services make analyzing and processing data easy.

Fast integration

Thanks to future-oriented industrial communication technology from Phoenix Contact, you can increase the degree of automation of your systems and easily integrate your energy data into higher-level control and management systems. Digitally processed data and global access provide you with a high degree of availability and transparency.



Only three steps needed for energy measurement

The user-controlled installation wizard enables intuitive configuration and quick startup. Benefit from the fast configuration baseline with only three steps:

- Set up the communication interface
- Select the power grid type
- Configure the current and voltage measuring input



Reduce wiring and configuration effort

Using versions with Rogowski measuring input will save you a lot of time when it comes to wiring and configuration:

You can directly connect every currently available Rogowski coil, regardless of manufacturer. Since the device can process the output signal of the coil directly, there is no need for the usual measuring transducer.



Simple service functions

Whenever service and support is required, you can export the current configuration data and the historically recorded list of errors and messages. This gives you some quick initial insights into the problem and can save on expensive service assignments.

Errors and alarm statuses that occur in the system are quickly and clearly recognizable on site, thanks to a color change on the display.

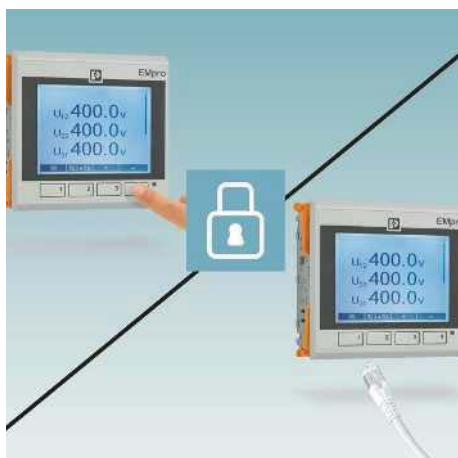

Increased data security

Protect your energy data from unauthorized access: shutting down operating elements at the device will prevent tampering on site.

By deactivating the interfaces, you avoid unwanted access to your energy data or unintentional changes to the configuration.



Flexible network connection

You can integrate these energy measuring devices into the most common industrial network structures and fieldbus systems. This means that the measured values can also be made available at the controller or in the control center for further processing. Each device additionally has a fixed Modbus/TCP interface on board.



Cost-center-precise billing

MID energy meters are used for billing cost centers. The measuring devices record the most important electrical parameters and make the data available to higher-level control systems using common communication interfaces.

DC current measurement up to 80 A without current transformer or measurement via current transformer.

Monitoring

Energy and power measuring

Energy measuring devices



Easy startup, monitoring, and servicing with the web server

The integrated user-guided web server simplifies startup, monitoring, and servicing.

Benefit from a variety of smart functions, such as:

- Intuitive configuration and startup
- Fast data duplication to multiple devices
- Easy inversion via web server in the event of the polarity reversal of current inputs
- Service-friendly recording and export of configuration data, and signal and error lists
- Secure remote deactivation of hardware operating elements and interfaces
- Easy monitoring of system states, thanks to built-in automatic operations and logic functions

Thanks to the simple structure of the web server, the entire range of functions is available at your fingertips, even in the case of complex applications.



Step 1: Set up the communication interface

Whether using DHCP or a static IP address, set up your communication interface in accordance with your application.



Step 2: Select the power grid type

Select the ideal grid type for your application from a variety of power grid types (2-, 3- or 4-conductor versions).



Step 3: Configure the current and voltage measuring input

You can create the basis for correct current and voltage measurements by configuring your upstream current sensors (or voltage transformers, as applicable).



Mean-value generation

Individually create up to 8 mean-value generations for your system with all current parameters with complete flexibility.



2+2 multiple tariff meter

Take advantage of the wide range of tariff meter options. Two tariff meters can be configured via the digital input. Two additional tariff meters can be configured by manual input or via Webserver.



Duplicate configuration files

Simply send the configuration file to other energy measuring devices in the same network using Webserver.



Firmware updates

Firmware updates allow you to be sure that your device is up to date at all times. You can also do individual specific updates.



Digital input with versatile functionality

Simply use the digital input with multiple functions that you can easily assign to the device during configuration.



Digital output with logic function capability

You can use the integrated logic function capability to configure individual behavior patterns with limit values at the digital output.

Energy meters

EMpro energy measuring devices are capable of detecting, monitoring, and analyzing any electrical parameters and forwarding them to higher-level systems.

Wide range of installation versions

- Front panel devices
- DIN rail devices with display
- DIN rail devices without display

Voltage measurement

- Direct up to 690 V AC or via transformer/transducer up to 2,000,000 V AC

Current measurement

- Via external current transformer up to 20,000 A, secondary adjustment 1/5 A

You will find the right accessories for measuring current using external current transformers starting on page 226.

- Via external directly connectable Rogowski coils

You will find the right accessories for measuring current using Rogowski coils starting on page 219.

Data logging

- Up to 8 mean values over a period of 90 days (15 min)
- Adjustable interval

Communication

- Modbus/TCP integrated
- Also available with Modbus/RTU, PROFINET, or EtherNet/IP™



new

For front-panel installation

Input data	
Measuring principle	direct
Acquisition of harmonics	direct
Measured value	via external transformers
Voltage measuring input	
Input voltage range	via external transformers
Accuracy	0.2%
Current measuring input I1, I2, I3	
Input current range	1 A (secondary) 5 A (secondary)
Overload capacity	6 A (I _{max})
Response threshold	10 mA (1 A) 50 mA (5 A)
Accuracy	0.2%
Power measurement	
Accuracy	0.5%
Active energy (IEC 62053-22)	Class 0.5 S
Reactive energy (IEC 62053-23)	Class 2
Digital input in accordance with IEC/EN 61131-2 (type 3)	
Voltage input signal	24 V DC 0 V DC ... 30 V DC
Digital output in accordance with IEC/EN 61131-2 (type 3)	
Voltage output signal	24 V DC
Current output signal	2 mA ... 15 mA
Display	
Type	LCD display, two-color, backlit
Data update rate	Adjustable: 500 ms, 1 s, 1.5 s
General data	
Supply voltage range	EEM-Mxxx0: 100 V AC ... 400 V AC ±20% 150 V DC ... 250 V DC (±20%) EEM-Mxxx1: 100 V AC ... 400 V AC ±20% 150 V DC ... 250 V DC (±20%)
Degree of protection	IP52 (display) IP30 (housing)
Ambient temperature (operation)	-10°C ... 55°C
Dimensions W/H/D	96 / 96 / 58 mm
Connection cross section (solid / stranded / AWG)	0.2 ... 6 mm ² / 0.2 ... 4 mm ² / 24 - 10
Conformance/approvals	
Conformance	CE-compliant

Technical data

True r.m.s. value measurement	
Up to 63rd harmonic	
AC sine (50/60 Hz)	
18 V AC ... 690 V AC (Phase/Phase)	
11 V AC ... 400 V AC (Phase/neutral conductor)	
60 V AC ... 2,000,000 V AC (primary)	
60 V AC ... 400 V AC (secondary)	
0.2%	
EEM-Mxxx0	EEM-Mxxx1
1 A (secondary)	4,000 A
5 A (secondary)	
6 A (I _{max})	I _{max}
10 mA (1 A)	5 A
50 mA (5 A)	
0.2%	<1%
500 µV ... 400 mV (1,000 A)	
EEM-Mxxx0	EEM-Mxxx1
0.5%	1%
Class 0.5 S	Class 1
Class 2	Class 2
24 V DC	
0 V DC ... 30 V DC	
24 V DC	
2 mA ... 15 mA	
LCD display, two-color, backlit	
Adjustable: 500 ms, 1 s, 1.5 s	
EEM-Mxxx0	EEM-Mxxx1
100 V AC ... 400 V AC ±20%	100 V AC ... 400 V AC ±20%
150 V DC ... 250 V DC (±20%)	150 V DC ... 250 V DC (±20%)
IP52 (display)	
IP30 (housing)	
-10°C ... 55°C	
96 / 96 / 58 mm	
0.2 ... 6 mm ² / 0.2 ... 4 mm ² / 24 - 10	
CE-compliant	

Ordering data

Description	Type	Order No.	Pcs./Pkt.
Energy measuring device, external current transformer required			
- Modbus/RTU (RS-485)	EEM-MA770-R	2907944	1
- Modbus/TCP (Ethernet)	EEM-MA770	2907945	1
- PROFINET (RJ45)	EEM-MA770-PN	2907946	1
- EtherNet/IP™ (RJ45)	EEM-MA770-EIP	2907953	1
Energy measuring device, external Rogowski coil required			
- Modbus/RTU (RS-485)	EEM-MA771-R	2908285	1
- Modbus/TCP (Ethernet)	EEM-MA771	2908286	1
- PROFINET (RJ45)	EEM-MA771-PN	2908301	1
- EtherNet/IP™ (RJ45)	EEM-MA771-EIP	2908302	1



For mounting on a DIN rail



For mounting on a DIN rail, without display

Technical data	
True r.m.s. value measurement up to 63rd harmonic AC sine (50/60 Hz)	
18 V AC ... 690 V AC (Phase/Phase) 11 V AC ... 400 V AC (Phase/neutral conductor) 60 V AC ... 2,000,000 V AC (primary) 60 V AC ... 400 V AC (secondary) 0.2%	
EEM-Mxxx0	EEM-Mxxx1
1 A (secondary)	4,000 A
5 A (secondary)	
6 A (I_{max})	I_{max}
10 mA (1 A)	5 A
50 mA (5 A)	
0.2%	<1%
	500 μ V ... 400 mV (1,000 A)
EEM-Mxxx0	EEM-Mxxx1
0.5%	1%
Class 0.5 S	Class 1
Class 2	Class 2
24 V DC 0 V DC ... 30 V DC	
24 V DC 2 mA ... 15 mA	
LCD display, two-color, backlit Adjustable: 500 ms, 1 s, 1.5 s	
EEM-Mxxx0	EEM-Mxxx1
100 V AC ... 230 V AC \pm 20%	100 V AC ... 230 V AC \pm 20%
150 V DC ... 250 V DC (\pm 20%)	150 V DC ... 250 V DC (\pm 20%)
IP52 (display)	
IP30 (housing)	
-10°C ... 55°C	
90 / 80 / 64 mm	
0.2 ... 6 mm ² / 0.2 ... 4 mm ² / 24 - 10	
CE-compliant	

Technical data	
True r.m.s. value measurement up to 63rd harmonic AC sine (50/60 Hz)	
18 V AC ... 690 V AC (Phase/Phase) 11 V AC ... 400 V AC (Phase/neutral conductor) 60 V AC ... 2,000,000 V AC (primary) 60 V AC ... 400 V AC (secondary) 0.2%	
EEM-Mxxx0	EEM-Mxxx1
1 A (secondary)	4,000 A
5 A (secondary)	
6 A (I_{max})	I_{max}
10 mA (1 A)	5 A
50 mA (5 A)	
0.2%	<1%
	500 μ V ... 400 mV (1,000 A)
EEM-Mxxx0	EEM-Mxxx1
0.5%	1%
Class 0.5 S	Class 1
Class 2	Class 2
24 V DC 0 V DC ... 30 V DC	
24 V DC 2 mA ... 15 mA	
-	
-	
EEM-Mxxx0	EEM-Mxxx1
100 V AC ... 230 V AC \pm 20%	100 V AC ... 230 V AC \pm 20%
150 V DC ... 250 V DC (\pm 20%)	150 V DC ... 250 V DC (\pm 20%)
IP30 (housing)	
-10°C ... 55°C	
90 / 80 / 64 mm	
0.2 ... 6 mm ² / 0.2 ... 4 mm ² / 24 - 10	
CE-compliant	

Ordering data		
Type	Order No.	Pcs./Pkt.
EEM-MA370-R	2907980	1
EEM-MA370	2907983	1
EEM-MA371-R	2907985	1
EEM-MA371	2908307	1

Ordering data		
Type	Order No.	Pcs./Pkt.
EEM-MB370	2907954	1
EEM-MB370-PN	2907984	1
EEM-MB370-EIP	2907971	1
EEM-MB371	2907955	1
EEM-MB371-PN	2908308	1
EEM-MB371-EIP	2907976	1

MID energy meters

- Capture electrical characteristics such as currents, voltages, power factors, powers, energy meters in all 4 quadrants and deliver them via bus or network interface
- Sealed covers, suitable for billing purposes
- For your energy management needs: mean values over configurable intervals, e.g., 10 s, 10 min, or 15 min

Direct measurement

- Measuring without external current transformers up to 80 A saves time and money

Measurement via external current transformers

- Configurable current transformer ratio
- Configurable input for secondary side 1 A or 5 A

Modbus/RTU and M-Bus

- Bus-compatible for your existing bus systems
- Can be configured via LC display or interface
- 2 tariffs, switchable via digital input

Ethernet

- Network-compatible for Modbus/TCP applications and/or web-based management
- Can be configured via LC display and buttons or via the integrated web-based management
- Store mean values (e.g., 10 s, 10 min, 15 min) and/or energy meter values in a circular buffer with multiple-month capacity (depending on settings)



new



Measuring device with M-Bus interface

ERIC

Input data	
Input voltage range	3x 184 V ... 288 V (320 V ... 500 V)
Frequency range	45 Hz ... 65 Hz
Start current I_{st}	0.002 A
Nominal current I_{ref}	1 A
Maximum current I_{max}	6 A
Communication interface	
Communication protocol	M-Bus
Communication standard	EN 13757-1-2-3
Transmission speed	300 bps ... 9600 bps
General data	
Degree of protection	IP51 (front) IP20 (connections)
Ambient temperature (operation)	-25°C ... 55°C
Ambient temperature (storage/transport)	-25°C ... 75°C
Humidity	80%
Dimensions W/H/D	72 / 90 / 67 mm
Connection data	
Measurement connection	Screw connection
Conductor cross section solid/stranded/AWG	1.5 ... 6 mm ²
Tightening torque	1.5 Nm
Other connections	Screw connection
Conductor cross section solid/stranded/AWG	0.14 ... 2.5 mm ²
Tightening torque	0.5 Nm
Conformance/approvals	
Conformance	CE-compliant MID-compliant EN 50470-1 / EN 50470-3
Standards/regulations	

Technical data		
EEM-EM325	EEM-EM327	
3x 184 V ... 288 V (320 V ... 500 V)	3x 184 V ... 288 V (320 V ... 500 V)	
45 Hz ... 65 Hz	45 Hz ... 65 Hz	
0.002 A	0.02 A	
1 A	5 A	
6 A	80 A	
Communication interface		
M-Bus		
EN 13757-1-2-3		
300 bps ... 9600 bps		
General data		
IP51 (front)		
IP20 (connections)		
-25°C ... 55°C		
-25°C ... 75°C		
80%		
72 / 90 / 67 mm		
Connection data		
Screw connection		
1.5 ... 6 mm ²	1.5 ... 35 mm ²	
1.5 Nm	2 Nm	
Screw connection		
0.14 ... 2.5 mm ²	0.14 ... 2.5 mm ²	
0.5 Nm	0.5 Nm	
Conformance/approvals		
CE-compliant		
MID-compliant		
EN 50470-1 / EN 50470-3		

Description
Three-phase energy meter for active power measurement with 1A/5A current transformer measurement in networks up to 500 V, with S0 output, certified in accordance with the MID directive
Three-phase energy meter for active power measurement with direct measurement in networks up to 500 V/80 A, with S0 output, certified in accordance with the MID directive

Ordering data		
Type	Order No.	Pcs./Pkt.
EEM-EM325	2908576	1
EEM-EM327	2908586	1

new

new



Measuring device with Modbus/RTU interface

Measuring device with Ethernet interface

ERC

ERC

Technical data

Technical data

EEM-EM355	EEM-EM357
3x 184 V ... 288 V (320 V ... 500 V)	3x 184 V ... 288 V (320 V ... 500 V)
45 Hz ... 65 Hz	45 Hz ... 65 Hz
0.002 A	0.02 A
1 A	5 A
6 A	80 A

EEM-EM375	EEM-EM377
3x 184 V ... 288 V (320 V ... 500 V)	3x 184 V ... 288 V (320 V ... 500 V)
45 Hz ... 65 Hz	45 Hz ... 65 Hz
0.002 A	0.02 A
1 A	5 A
6 A	80 A

Modbus
RS-485
300 bps ... 57600 bps

Modbus/TCP
IEEE 802.3
10 Mbps ... 100 Mbps

IP51 (front)
IP20 (connections)
-25°C ... 55°C
-25°C ... 75°C
80%
72 / 90 / 67 mm

IP51 (front)
IP20 (connections)
-25°C ... 55°C
-25°C ... 75°C
80%
72 / 90 / 67 mm

Screw connection	
1.5 ... 6 mm ²	1.5 ... 35 mm ²
1.5 Nm	2 Nm
Screw connection	
0.14 ... 2.5 mm ²	0.14 ... 2.5 mm ²
0.5 Nm	0.5 Nm

Screw connection	
1.5 ... 6 mm ²	1.5 ... 35 mm ²
1.5 Nm	2 Nm
Screw connection	
0.14 ... 2.5 mm ²	0.14 ... 2.5 mm ²
0.5 Nm	0.5 Nm

CE-compliant
MID-compliant
EN 50470-1 / EN 50470-3

CE-compliant
MID-compliant
EN 50470-1 / EN 50470-3

Ordering data

Ordering data

Type	Order No.	Pcs./Pkt.
EEM-EM355	2908578	1
EEM-EM357	2908588	1

Type	Order No.	Pcs./Pkt.
EEM-EM375	2908581	1
EEM-EM377	2908590	1

Controller solutions for usage data acquisition



The EMlog software from Phoenix Contact provides an efficient solution for recording energy data relating to heat, cold, air, and electricity when used in conjunction with the ILC 191 ME/AN modular Inline controller. This allows you to keep an eye on your resources and manage the consumption levels of your machines and systems.

Your advantages:

- Easy startup without programming knowledge
- Easy configuration, thanks to web-based interface
- Direct configuration of predefined sensors
- Existing configurations can be reused



Solution for usage data acquisition



Interfaces	
INTERBUS local bus (master)	
Ethernet	
Configuration/operation/diagnostics	
INTERBUS master	
Number of devices with parameter channel	
Number of supported devices	
Amount of process data	
Digital inputs/outputs	
Number of inputs	8
Number of outputs	4
Analog inputs/outputs	
Number of inputs	2
Number of outputs	2
IEC-61131 runtime system	
Programming tool	PC WORX PC WORX EXPRESS Altera Nios II 64 MHz 1 Mbyte 1 Mbyte 48 kByte (NVRAM) Depends on mass storage Depends on mass storage 8 Yes
Processor	
Program memory	
Mass storage	
Retentive mass storage	
Number of data blocks	
Number of timers, counters	
Number of control tasks	
Realtime clock	
Power supply	
Supply voltage	24 V DC
Supply voltage range	19.2 V DC ... 30 V DC
Typical current consumption	310 mA
General data	
Dimensions	W / H / D 164 mm / 136.8 mm / 71.5 mm
Degree of protection	IP20
Ambient temperature (operation)	-25°C ... 55°C
EMC note	Class A product, see page 583

Technical data		
Inline data jumper		
2 x RJ45 socket		
1 x 6-pos. MINI DIN socket (PS/2)		
Max. 24		
Max. 128		
Max. 4096 Bit (INTERBUS)		
Max. 32768 Bit (internal Modbus /TCP client)		
8		
4		
2		
2		
PC WORX PC WORX EXPRESS Altera Nios II 64 MHz 1 Mbyte 1 Mbyte 48 kByte (NVRAM) Depends on mass storage Depends on mass storage 8 Yes		
24 V DC		
19.2 V DC ... 30 V DC		
310 mA		
164 mm / 136.8 mm / 71.5 mm		
IP20		
-25°C ... 55°C		
Class A product, see page 583		

Description
Compact controller , complete with accessories (connector plug and labeling field) - Analog inputs/outputs
Program and configuration memory , plug-in, 2 GB with license key and user program for reading from measuring devices

Ordering data		
Type	Order No.	Pcs./Pkt.
ILC 191 ME/AN	2700074	1
SD FLASH 2GB EMLOG	2403484	1

Programming cable

Accessories		
Type	Order No.	Pcs./Pkt.
COM CAB MINI DIN	2400127	1

Complete packages for data logging

The PSK RTU 50 is a multifunctional RTU (Remote Telemetry Unit), which combines the functions of a data logger, gateway, and alarm manager. The PSK RTU 50 offers various communication options, was developed with low power technology and allows independent operation, e.g., with batteries or solar cells.

Your advantages:

- GSM/GPRS modem
- Ethernet interface
- IEC 60870-5-101
- IEC 60870-5-104
- Modbus/RTU



Multifunctional data logger

Technical data			
Interfaces	RS-232 RS-232/-485 Serial Ethernet		
Digital inputs/outputs			
Number of inputs	4		
Number of outputs	2 (relay output)		
Analog inputs			
Number of inputs	2		
IEC-61131 runtime system			
Program memory	832 kByte		
Retentive mass storage	1 Mbyte		
Realtime clock	Yes (battery-backed)		
Power supply			
Supply voltage	24 V DC		
Typical current consumption	5 mA		
General data			
Weight	475 g		
Width	210 mm		
Height	110 mm		
Depth	45 mm		
Degree of protection	IP20		
Ambient temperature (operation)	-20°C ... 65°C		
Ordering data			
Description	Type	Order No.	Pcs./Pkt.
Multifunctional data logger	PSK RTU 50	2400018	1



Extremely versatile

PACT current transformers offer a complete product range for converting alternating currents up to 4,000 A into secondary currents of 1 A and 5 A. Depending on requirements, bus-bar, plug-in, and winding current transformers are available. PACT current transformers are available in different transformation ratios, accuracy classes, and rated powers in 3,000 versions for your current measurement requirements.

Also available for higher accuracy classes

For standard applications, such as in machine building or system manufacturing, Phoenix Contact offers current transformers with accuracy classes 0.5 and 1 in a version that cannot be calibrated.

For higher accuracy or for billing purposes in energy supply, type-tested transformers that can be calibrated as well as calibrated transformers are available – with classes 0.2/0.2S/0.5 and 0.5S.



Fast and secure installation

The current transformer quick-action mechanism offers the following advantages:

- Tool-free mounting
- Considerable reduction in installation time
- Easy handling and secure fastening by pressing with finger
- Current transformers align themselves – no need for subsequent alignment

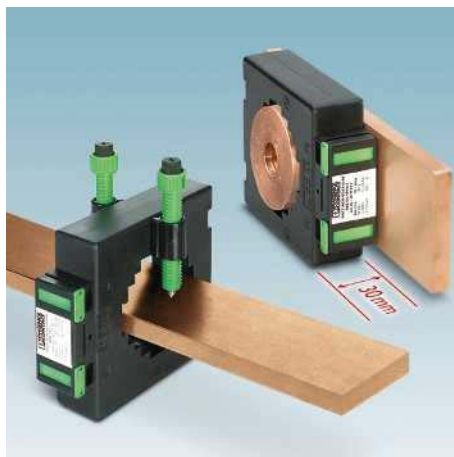

Variable and space-saving mounting

In addition to the vertical and horizontal mounting position, the optional accessories offer further installation options such as mounting on the DIN rail or on the control cabinet panel.

All PACT current transformers are just 30 mm wide. This saves space – for example with flat mounting when measuring branch outlets.

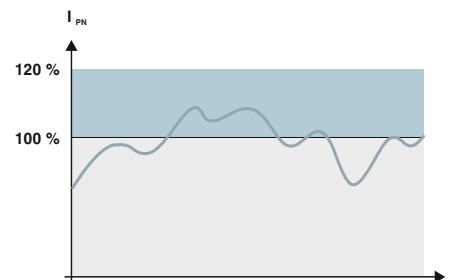

Safely detecting current peaks

PACT current transformers can be used to safely detect current peaks greater than the rated nominal current strength – without resulting in any damage. The transformers are designed for a thermal nominal continuous current of 120% of the primary rated current strength.

Example: a PACT transformer with a specified rated power of 10 VA actually delivers 14.4 VA on a continual basis.

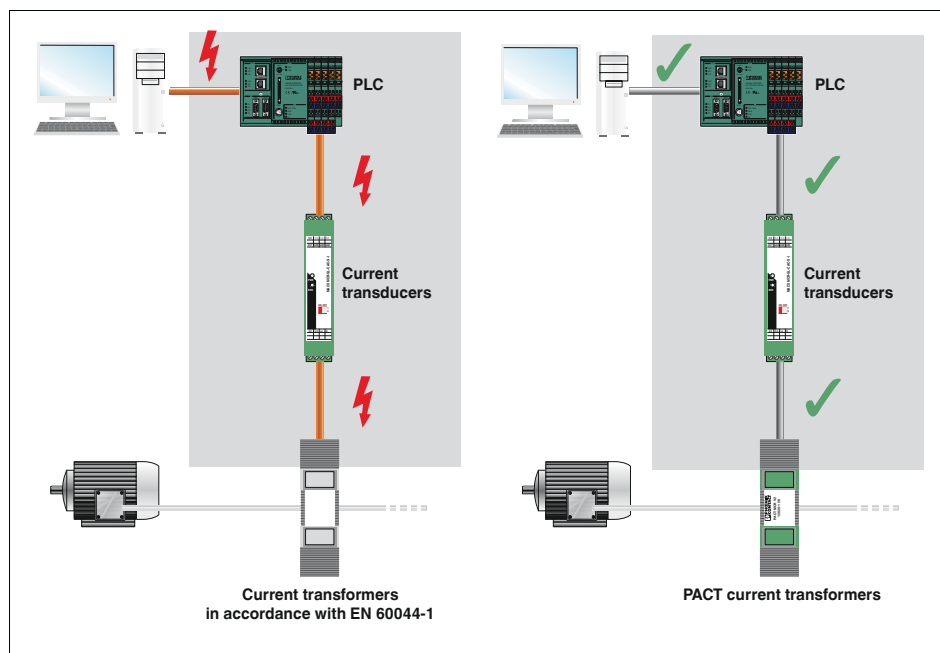

Safe isolation

PACT current transformers are manufactured in accordance with EN 50178. This is relevant for electronic equipment for use in power installations.

EN 50178 differs considerably from EN 60044, the usual standard for transformers, with regard to safety.

Your advantages:

- PACT current transformers offer safe isolation, thanks to greater air clearances and creepage distances
- PACT current transformers ensure that there is no sparkover on the secondary side of the transformer and human life is protected inside and outside the control cabinet
- Up to 1,000 V (L-N) operating voltage possible
- Routine testing with 12 kV (1.2/50 μ s)
- Meets overvoltage category 3

Monitoring

Current measurement

Current transformer selection guide

- Complete range consisting of winding, bus-bar, and window-type current transformers
- Popular types available from stock; alternatively, order key can be used for custom dimensioning
- Versions available to support official calibration



Selection

- Select your converter in accordance with the dimensions of the copper rail
- Specify the four electrical characteristics of the converter:

- 1. The primary rated current I_{pn}** – the maximum amperage occurring in the path to be measured
- 2. The secondary rated current I_{sn}** – supplied to the downstream measuring devices
- 3. Class** – accuracy for adherence to the specified tolerances
- 4. Rated power S_n [VA]** – takes account of all the loads occurring in the measuring circuit

Input data

Thermal rated short-time current
Rated surge current
Rated frequency

Surge current limitation factor

General data

Rated insulation voltage
Impulse withstand voltage
Insulating material class
Connection capacity of secondary terminals
Ambient temperature (operation)
Standards/regulations
Housing material

UL data

Ambient temperature (operation)

Temperature increase

Technical data

$I_{th} = 60 \cdot I_n$
 $I_{dyn} = 2.5 \cdot I_{th}$
50 Hz ... 60 Hz
50 Hz
FS 5

1 kV (Phase/neutral conductor)
12 kV (1.2/50 μ s)
E
2 x (2.5 x 4) mm
-25°C ... 40°C
EN 50178, EN 61869
PA 6.6

-25°C ... 30°C (up to a primary rated current of 1600 A AC)
55°C (at a primary rated current of 50 A AC ... 400 A AC)
65°C (at a primary rated current of 500 A AC ... 800 A AC)
80°C (at a primary rated current of 1,000 A AC ... 1600 A AC)

Calculation guide

Determination of the secondary side rated power S_n

All the occurring loads must be added:

- Calculate the power requirement of the copper wire (forward and return line)
- Take into account the power requirement of the connected devices (measuring devices)
- Add a reserve requirement

$$S_n \text{ total} = S_n \text{ copper wire} + S_n \text{ measuring device} + S_n \text{ reserve}$$

Power requirement of copper wires with a different diameter

Conductor cross section in mm ²	Rated power in VA/m (consider the forward and return line)	
	Secondary current I_{sn} 5 A	Secondary current I_{sn} 1 A
1.5	0.2917	0.0117
2.5	0.1750	0.0070
4	0.1094	0.0044
6	0.0729	0.0029

Example:

S_n copper wire = cable length x 2 x rated power
 S_n copper wire = 10 m x 2 x 0.1750 VA/m = 3.50 VA

S_n measuring device = 2 VA

S_n reserve < 0.5 x (S_n copper wire + S_n measuring device)
 S_n reserve = 2 VA

S_n total = S_n copper wire + S_n measuring device + S_n reserve
 S_n total = 3.5 VA + 2 VA + 2 VA = 7.5 VA

Order key - example for PACT MCR-V2-3015-60

Preferred types that can be ordered directly are marked in green in the selection table.

Order No.	Primary current I_{pn}	Secondary current I_{sn}	Class	Rated power S_n
2277271	IP02000	IS05	C10	P750
	IP00600 $\hat{=}$ 60 A IP00750 $\hat{=}$ 75 A IP00800 $\hat{=}$ 80 A IP01000 $\hat{=}$ 100 A IP01250 $\hat{=}$ 125 A IP02000 $\hat{=}$ 200 A IP02500 $\hat{=}$ 250 A	IS01 $\hat{=}$ 1 A IS05 $\hat{=}$ 5 A	C02 $\hat{=}$ 0.2 C05 $\hat{=}$ 0.5 C10 $\hat{=}$ 1	P125 $\hat{=}$ 1.25 VA P250 $\hat{=}$ 2.5 VA P375 $\hat{=}$ 3.75 VA P500 $\hat{=}$ 5.0 VA P750 $\hat{=}$ 7.5 VA P1000 $\hat{=}$ 10 VA

Selection table (extract)

I_{sn}	Cl.	Primary rated current strength I_{pn} [A]								Rated power S_n [VA]	
		60	75	80	100	125	150	200	250		
1 A	0.5				1.25	2.5	2.5	2.5	2.5	2.5	5
	1					3.75	5	5	5	5	7.5
	0.5							2.5	3.75	5	5
5 A	1	1.25	1.25	1.25	2.5	2.5	2.5	2.5	2.5	5	5
	0.5					3.75	3.75	5	5	5	10

Current transformers

PACT MCR-V1-21-44

- Primary rated current I_{pn} : 0...(50...500) A
- Round conductor dimensions: \varnothing 21 mm

Notes:
Our configurator, which is available at phoenixcontact.net/products, makes ordering easy.

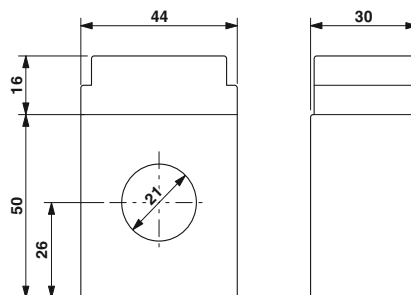

Bus-bar current transformer, official calibration as an option

ERC

		Ordering data		
Description	Rated power S_n	Type	Order No.	Pcs./Pkt.
Primary rated current I_{pn}:				
- 50 A	1.25 VA	PACT MCR-V1-21-44- 50-5A-1	2277019	1
- 75 A	2.5 VA	PACT MCR-V1-21-44- 75-5A-1	2277611	1
- 100 A	2.5 VA	PACT MCR-V1-21-44-100-5A-1	2277022	1
- 125 A	3.75 VA	PACT MCR-V1-21-44-125-5A-1	2277763	1
- 150 A	5 VA	PACT MCR-V1-21-44-150-5A-1	2277035	1
- 200 A	5 VA	PACT MCR-V1-21-44-200-5A-1	2277776	1
- 250 A	5 VA	PACT MCR-V1-21-44-250-5A-1	2277048	1
- 300 A	10 VA	PACT MCR-V1-21-44-300-5A-1	2277789	1
- 400 A	5 VA	PACT MCR-V1-21-44-400-5A-1	2277051	1
- 500 A	10 VA	PACT MCR-V1-21-44-500-5A-1	2277792	1
Current transformers, note the following ordering key for determining the desired current transformer type				
		PACT MCR-V1-21-44	2277268	1

Add order key from the selection table (ordering example marked in orange)

Order No.	Primary current I_{pn}	Secondary current I_{sn}	Class	Rated power S_n
2277268	IP05000	IS01	C05	P1000

Selection table PACT MCR-V1-21-44 (Order No.: 2277268)

I_{sn}	Cl.	Primary rated current amperage I_{pn} [A]										Rated power S_n [VA]		
		50	75	100	125	150	200	250	300	400				
IS01 ≅ 1 A	C05 ≅ 0.5			1.25		2.5	2.5							
	C10 ≅ 1	1.25	2.5	2.5		2.5	2.5							
IS05 ≅ 5 A	C05 ≅ 0.5			1.25		1.25	2.5							
	C10 ≅ 1	1.25	2.5	2.5		3.75	5	5	5		10			

Monitoring

Current measurement

Current transformers

PACT MCR-V2-3015-60

- Primary rated current I_{pn} :
0...(50...750) A
- Round conductor dimensions: \varnothing 28 mm
- Rail dimensions:
30x15 mm, 20x20 mm

Notes:
Our configurator, which is available at phoenixcontact.net/products, makes ordering easy.

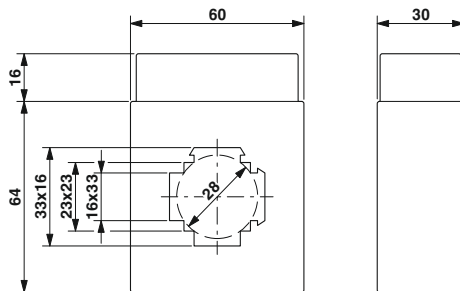

Window-type current transformer, official calibration as an option

ERIC

Ordering data

Description	Rated power S_n	Type	Order No.	Pcs./Pkt.
Primary rated current I_{pn}:				
- 60 A	1.25 VA	PACT MCR-V2-3015- 60- 60-5A-1	2277815	1
- 80 A	1.25 VA	PACT MCR-V2-3015- 60- 80-5A-1	2277831	1
- 100 A	2.5 VA	PACT MCR-V2-3015- 60- 100-5A-1	2277064	1
- 125 A	3.75 VA	PACT MCR-V2-3015- 60- 125-5A-1	2277624	1
- 150 A	3.75 VA	PACT MCR-V2-3015- 60- 150-5A-1	2277844	1
- 150 A	5 VA	PACT MCR-V2- 3015- 60-150-5A-1	2277077	1
- 200 A	5 VA	PACT MCR-V2-3015- 60- 200-5A-1	2277637	1
- 200 A	7.5 VA	PACT MCR-V2-3015- 60- 200-5A-1	2277857	1
- 250 A	7.5 VA	PACT MCR-V2-3015- 60- 250-5A-1	2277860	1
- 250 A	10 VA	PACT MCR-V2- 3015- 60-250-5A-1	2277080	1
- 300 A	7.5 VA	PACT MCR-V2-3015- 60- 300-5A-1	2277640	1
- 400 A	10 VA	PACT MCR-V2- 3015- 60-400-5A-1	2277093	1
- 500 A	10 VA	PACT MCR-V2-3015- 60- 500-5A-1	2277653	1
- 600 A	10 VA	PACT MCR-V2-3015- 60- 600-5A-1	2277103	1
- 750 A	10 VA	PACT MCR-V2-3015- 60- 750-5A-1	2277666	1
Current transformers, pay attention to the following ordering key for determining the desired current transformer type				
with screw connection		PACT MCR-V2- 3015- 60	2277271	1
with Push-in connection		PACT MCR-V2-3015-60-PT	2907413	1

Accessories

Quick-action mechanism	Order No.	Pcs./Pkt.	
Fixing pin length 40 mm	PACT-FAST-MNT-W16-L40	2276638	1
Fixing pin length 65 mm	PACT-FAST-MNT-W16-L65	2276641	1

Add **order key** from the selection table (ordering example marked in orange)

Order No.	Primary current I_{pn}	Secondary current I_{sn}	Class	Rated power S_n
2277271	IP07500	IS01	C05	P1500

Selection table PACT MCR-V2-3015-60 (Order No.: 2277271)

I_{sn}	Cl.	Primary rated current amperage I_{pn} [A]											Rated power S_n [VA]				
		60	80	100	125	150	200	250	300	400	500	600		750			
IS01 \approx 1A	C05 \approx 0.5			1.25		2.5		3.75		5		5					
	C10 \approx 1	1.25		2.5		5		5		7.5							
IS05 \approx 5 A	C05 \approx 0.5							2.5		3.75		5		10			
	C10 \approx 1	1.25	1.25	2.5		3.75	3.75	5		5	7.5	7.5	10	10	10	10	10

Current transformers

PACT MCR-V2-4012-70

- Primary rated current I_{pn} : 0...(75...1,000) A
- Round conductor dimensions: \varnothing 33 mm
- Rail dimensions: 40x12 mm, 2x 30x10 mm

Notes:
Our configurator, which is available at phoenixcontact.net/products, makes ordering easy.

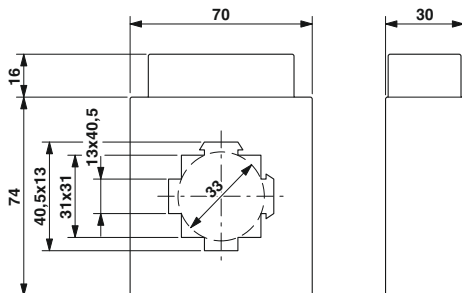

Window-type current transformer, official calibration as an option

ERC

Description		Rated power S_n	Ordering data		
Type	Order No.	Pcs./Pkt.			
Primary rated current I_{pn}:					
- 250 A	5 VA	PACT MCR-V2-4012- 70- 250-5A-1	2277116	1	
- 300 A	7.5 VA	PACT MCR-V2-4012- 70- 300-5A-1	2277679	1	
- 400 A	7.5 VA	PACT MCR-V2-4012- 70- 400-5A-1	2277129	1	
- 500 A	10 VA	PACT MCR-V2-4012- 70- 500-5A-1	2277682	1	
- 600 A	10 VA	PACT MCR-V2-4012- 70- 600-5A-1	2277132	1	
- 750 A	10 VA	PACT MCR-V2-4012- 70- 750-5A-1	2277695	1	
- 800 A	10 VA	PACT MCR-V2-4012- 70- 800-5A-1	2277145	1	
- 1,000 A	10 VA	PACT MCR-V2-4012- 70-1000-5A-1	2277158	1	
Current transformers , pay attention to the following ordering key for determining the desired current transformer type					
with screw connection			PACT MCR-V2- 4012- 70	2277284	1
with Push-in connection			PACT MCR-V2-4012-70-PT	2907414	1
Quick-action mechanism					
Fixing pin length 40 mm			PACT-FAST-MNT-W13-L40	2276612	1
Fixing pin length 65 mm			PACT-FAST-MNT-W13-L65	2276625	1

Add **order key** from the selection table (ordering example marked in orange)

Order No.	Primary current I_{pn}	Secondary current I_{sn}	Class	Rated power S_n
2277284	IP010000	IS05	C10	P250

Selection table PACT MCR-V2-4012-70 (Order No.: 2277284)

I_{sn}	Cl.	Primary rated current amperage I_{pn} [A]										Rated power S_n [VA]			
		100	150	200	250	300	400	500	600	750	800		1000		
IS01 ≅ 1A	C05 ≅ 0.5		2.5		2.5	2.5		5		5					
	C10 ≅ 1	2.5		5	5		7.5	7.5		10					
IS05 ≅ 5A	C05 ≅ 0.5		2.5		5	5		7.5	7.5		10				
	C10 ≅ 1	2.5		5	5	5	7.5	7.5	10	10	10	10	10		

Monitoring

Current measurement

Current transformers

PACT MCR-V2-5012-85

- Primary rated current I_{pn} :
0...(100...1,500) A
- Round conductor dimensions: \varnothing 42 mm
- Rail dimensions:
50x12 mm, 2x 40x10 mm

Notes:
Our configurator, which is available at phoenixcontact.net/products, makes ordering easy.

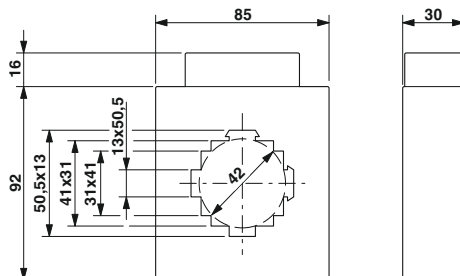

Window-type current transformer, official calibration as an option

ERIC

Description		Rated power S_n	Ordering data		
Type		Order No.	Pcs./Pkt.		
Primary rated current I_{pn}:					
- 150 A		3.75 VA	PACT MCR-V2-5012- 85- 150-5A-1	2276117	1
- 200 A		5 VA	PACT MCR-V2-5012- 85- 200-5A-1	2276120	1
- 250 A		7.5 VA	PACT MCR-V2-5012- 85- 250-5A-1	2276133	1
- 300 A		10 VA	PACT MCR-V2-5012- 85- 300-5A-1	2276146	1
- 400 A		10 VA	PACT MCR-V2-5012- 85- 400-5A-1	2277161	1
- 500 A		15 VA	PACT MCR-V2-5012- 85- 500-5A-1	2276159	1
- 600 A		10 VA	PACT MCR-V2-5012- 85- 600-5A-1	2277174	1
- 600 A		15 VA	PACT MCR-V2-5012- 85- 600-5A-1	2276162	1
- 750 A		10 VA	PACT MCR-V2-5012- 85- 750-5A-1	2276175	1
- 800 A		10 VA	PACT MCR-V2-5012- 85- 800-5A-1	2277187	1
- 1,000 A		10 VA	PACT MCR-V2-5012- 85-1000-5A-1	2276463	1
- 1,000 A		15 VA	PACT MCR-V2-5012- 85-1000-5A-1	2277190	1
- 1,250 A		15 VA	PACT MCR-V2-5012- 85-1250-5A-1	2277200	1
- 1,500 A		15 VA	PACT MCR-V2-5012- 85-1500-5A-1	2276188	1
Current transformers, pay attention to the following ordering key for determining the desired current transformer type					
with screw connection			PACT MCR-V2- 5012- 85	2277297	1
with Push-in connection			PACT MCR-V2-5012-85-PT	2907416	1
Quick-action mechanism					
Fixing pin length 40 mm			PACT-FAST-MNT-W13-L40	2276612	1
Fixing pin length 65 mm			PACT-FAST-MNT-W13-L65	2276625	1

Add **order key** from the selection table (ordering example marked in orange)

Order No.	Primary current I_{pn}	Secondary current I_{sn}	Class	Rated power S_n
2277297	IP02500	IS01	C10	P750

Selection table PACT MCR-V2-5012-85 (Order No.: 2277297)

I_{sn}	Cl.	Primary rated current amperage I_{pn} [A]													Rated power S_n [VA]		
		100	150	200	250	300	400	500	600	750	800	1000	1250	1500			
IS01 ≅ 1A	C05 ≅ 0.5		1.25	2.5			2.5			5	5	5		5			
	C10 ≅ 1	1.25			2.5			2.5			5			15			
IS05 ≅ 5A	C05 ≅ 0.5		1.25		5		5		5	5			10				
	C10 ≅ 1	1.25		3.75	5		7.5	10	10	15	15	10	10	10	15	15	15

Current transformers

PACT MCR-V2-6015-85

- Primary rated current I_{pn} : 0...(200...1600) A
- Round conductor dimensions: \varnothing 52 mm
- Rail dimensions: 60x15 mm, 2x 50x10 mm, 40x40 mm

Notes:
Our configurator, which is available at phoenixcontact.net/products, makes ordering easy.

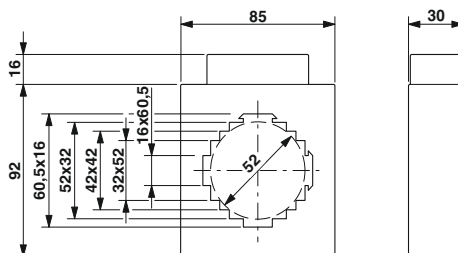

Window-type current transformer, official calibration as an option

ERC

Description		Rated power S_n	Ordering data		
Type	Order No.	Pcs./Pkt.			
Primary rated current I_{pn}:					
- 200 A	2.5 VA	PACT MCR-V2-6015- 85- 200-5A-1	2277873	1	
- 400 A	2.5 VA	PACT MCR-V2-6015- 85- 400-5A-1	2277909	1	
- 500 A	5 VA	PACT MCR-V2-6015- 85- 500-5A-1	2277912	1	
- 600 A	10 VA	PACT MCR-V2-6015- 85- 600-5A-1	2277925	1	
- 750 A	10 VA	PACT MCR-V2-6015- 85- 750-5A-1	2277938	1	
- 800 A	10 VA	PACT MCR-V2-6015- 85- 800-5A-1	2277941	1	
- 1,000 A	15 VA	PACT MCR-V2-6015- 85-1000-5A-1	2277954	1	
- 1250 A	15 VA	PACT MCR-V2-6015- 85-1250-5A-1	2277967	1	
Current transformers , pay attention to the following ordering key for determining the desired current transformer type					
with screw connection			PACT MCR-V2- 6015- 85	2277336	1
with Push-in connection			PACT MCR-V2-6015-85-PT	2907417	1
Quick-action mechanism					
Fixing pin length 40 mm			PACT-FAST-MNT-W16-L40	2276638	1
Fixing pin length 65 mm			PACT-FAST-MNT-W16-L65	2276641	1

Add **order key** from the selection table (ordering example marked in orange)

Order No.	Primary current I_{pn}	Secondary current I_{sn}	Class	Rated power S_n
2277336	IP05000	IS01	C10	P375

Selection table PACT MCR-V2-6015-85 (Order No.: 2277336)

I_{sn}	Cl.	Primary rated current strength I_{pn} [A]											Rated power S_n [VA]	
		200	300	400	500	600	750	800	1000	1250	1500			
IS01 ≅ 1A	C05 ≅ 0.5		1.25		2.5		2.5		2.5		2.5			
	C10 ≅ 1		2.5			2.5		2.5	3.75	3.75				
IS05 ≅ 5A	C05 ≅ 0.5					5		5	5	10				
	C10 ≅ 1	2.5		2.5		5		10	10	10	15	15	15	

Monitoring

Current measurement

Current transformers

PACT MCR-V2-10020-129

- Primary rated current I_{pn} :
0...(400...4,000) A
- Round conductor dimensions: \varnothing 85 mm
- Rail dimensions:
2x100x10 mm, 80x64 mm

Notes:
Our configurator, which is available at phoenixcontact.net/products, makes ordering easy.

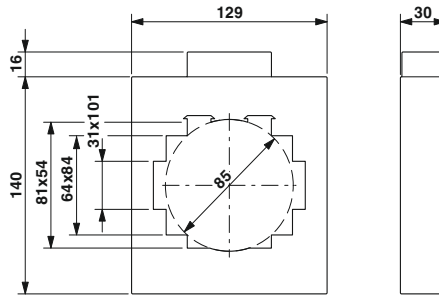

Window-type current transformer, official calibration as an option

ERC

		Ordering data		
Description	Rated power S_n	Type	Order No.	Pcs./Pkt.
Primary rated current I_{pn} : - 2500 A	15 VA	PACT MCR-V2-10020-129-2500-5A	2276395	1
Current transformers, pay attention to the following ordering key for determining the desired current transformer type		PACT MCR-V2-10020-129	2277378	1

Add order key from the selection table (ordering example marked in orange)

Order No.	Primary current I_{pn}	Secondary current I_{sn}	Class	Rated power S_n
2277378	IP40000	IS05	C05	P2500

Selection table PACT MCR-V2-10020-129 (Order No.: 2277378)

I_{sn}	Cl.	Primary rated current amperage I_{pn} [A]							Rated power S_n [VA]
		800	1000	1500	2000	2500	3000	4000	
$\cong 1A$	C05 $\cong 0.5$	5							
		10		10		10			
	C10 $\cong 1$						5		
		10	10	10		15	15	30	
$\cong 5A$	C05 $\cong 0.5$	5							
				10	10	10		15	25
	C10 $\cong 1$								
		10	10	10		15	15	10	
					25				

Current transformers

PACT MCR-V3-60

– Primary rated current I_{pn} :
0...(1...40) A

– Current-carrying copper lines connected directly to the screw terminal blocks on the primary side

Notes:
Our configurator, which is available at phoenixcontact.net/products, makes ordering easy.

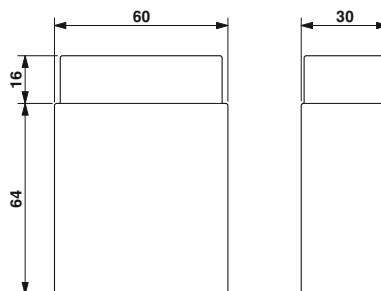

Winding current transformer



Ordering data		
Type	Order No.	Pcs./Pkt.
PACT MCR-V3-60	2277417	1

Description

Current transformers, pay attention to the following ordering key for determining the desired current transformer type

Add order key from the selection table (ordering example marked in orange)

Order No.	Primary current I_{pn}	Secondary current I_{sn}	Class	Rated power S_n
2277417	IP00025	IS01	C10	P250

Selection table PACT MCR-V3-60 (Order No.: 2277417)

I_{sn}	Cl.	Primary rated current amperage I_{pn} [A]										Rated power S_n [VA]	
		1	2	5	10	15	20	25	30	40			
IS01 ≅ 1A	C05 ≅ 0.5	2.5	2.5	2.5	2.5	2.5	2.5	2.5	2.5	2.5	2.5	2.5	
	C10 ≅ 1	5	5	5	5	5	5	5	5	5	5	5	
IS05 ≅ 5A	C05 ≅ 0.5			2.5	2.5	2.5	2.5	2.5	2.5	2.5	2.5	2.5	
	C10 ≅ 1			5	5	5	5	5	5	5	5	5	

Monitoring

Current measurement

Accessories

Quick-action mechanism for PACT current transformers

- No tools necessary for mounting
- Extremely easy handling, thanks to secure fastening by pressing with finger
- Set consisting of two fixing pins and a holding latch

Notes:
The 16 mm wide quick-action mechanism can also be used for larger current transformers if the length of the fixing pins is sufficient.



For: ...V2-4012-70..., ...V2-5012-85...



For: ...V2-3015-60..., ...V2-6015-85..., ...V2-6315-95...

General data	
Ambient temperature (operation)	-25°C ... 120°C
Width of the retaining bracket [mm]	13

Technical data		
-25°C ... 120°C		
13		

Description	
Quick-action mechanism	
Fixing pin length 65 mm	
Fixing pin length 40 mm	
Quick-action mechanism	
Fixing pin length 65 mm	
Fixing pin length 40 mm	

Ordering data		
Type	Order No.	Pcs./Pkt.
PACT-FAST-MNT-W13-L65	2276625	1
PACT-FAST-MNT-W13-L40	2276612	1

Technical data		
-25°C ... 120°C		
16		

Ordering data		
Type	Order No.	Pcs./Pkt.
PACT-FAST-MNT-W16-L65	2276641	1
PACT-FAST-MNT-W16-L40	2276638	1

Accessories

- DIN rail adapter



DIN rail adapter

Description	
DIN rail adapter	

Ordering data		
Type	Order No.	Pcs./Pkt.
PACT MCR-RA	2277598	12

Accessories

new

PACT RCP Rogowski coils

- For direct connection to EMpro energy measuring devices, see page 210
- Practical handling due to the flexible measuring coil for opening
- The large bandwidth from 40 Hz to 20,000 Hz enables harmonics and transients to be detected
- It is not possible for dangerous open circuit voltages to occur
- The bracket ensures optimum alignment of the measuring coil to the power rail
- Low space requirement in the control cabinet



Ordering data

Description	Type	Order No.	Pcs./Pkt.
Length: measuring coil 300 mm, signal line 3 m	PACT RCP-D95	2904890	1
Length: measuring coil 450 mm, signal line 3 m	PACT RCP-D140	2904891	1
Length: measuring coil: 600 mm, signal line 3 m	PACT RCP-D190	2904892	1
Length: measuring coil 300 mm, signal line 5 m	PACT RCP-D95-5M	2910322	1
Length: measuring coil 300 mm, signal line 10 m	PACT RCP-D95-10M	2910323	1
Length: measuring coil 450 mm, signal line 10 m	PACT RCP-D140-10M	1033482	1
Length: measuring coil 600 mm, signal line 10 m	PACT RCP-D190-10M	2910324	1

Recommendation for the use of coil lengths and busbars

Busbar [mm x mm]	Diameter/coil length [mm]	1 busbar per phase	2 busbars per phase	3 busbars per phase
30 x 10	95/300	X	X	-
40 x 10	95/300	X	X	-
40 x 10	140/450	-	-	X
50 x 10	95/300	X	-	-
50 x 10	140/450	-	X	X
60 x 10	95/300	X	-	-
60 x 10	140/450	-	X	X
80 x 10	140/450	X	X	X
100 x 10	140/450	X	X	-
100 x 10	190/600	-	-	X
120 x 10	140/450	X	-	-
120 x 10	190/600	-	X	X
160 x 10	190/600	X	X	X



Fast installation in a confined space

PACT RCP current transformers for retrofitting can be conveniently mounted where there is not enough space for split core current transformers. System downtimes are reduced as system parts do not have to be removed for installation.

Your advantages:

- High system availability due to reduced downtimes: fast installation without removing system parts
- Safe installation and operation:
 - no dangerous open circuit voltages
- No magnetic saturation
- High linearity, even at high currents
- Responds to fast current changes
- The coil is protected against electromagnetic interference
- The current can rise up to the short-circuit current without necessarily destroying the coil
- High nominal isolation voltage

Professional holding device for busbars

The PACT RCP-CLAMP holding device offers the following advantages:

- Suitable for industrial applications
- Steel bracket ensures permanent fixed seating at high busbar temperatures
- Designed for rails with a thickness of 10 to 15 mm
- Rogowski coil is snapped onto the fixing element
- Rogowski coil has a safe and defined place on the busbar
- Rogowski coil can be rotated in 15°-steps for optimum alignment
- PACT RCP avoids direct contact of the measuring coil to its own or adjacent busbar
- This allows installations on warm busbars to remain under control



Easy and safe installation

Simply place the handy Rogowski coil quickly around power rails and circular conductors. The measuring transducer connected downstream supplies the same typical secondary currents as a standard current transformer.

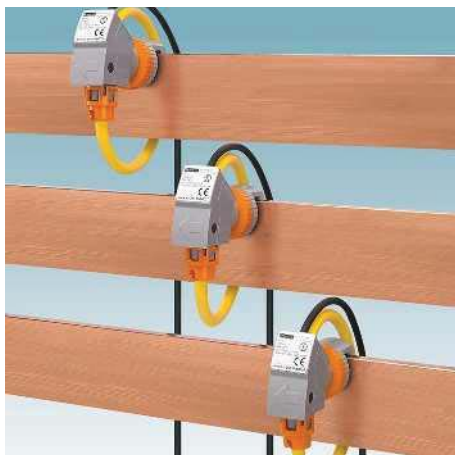

Fast installation in a confined space

PACT RCP current transformers save space and are handy as the size and weight of the Rogowski coil are not dependent on the amperage and unlike split core current transformers, remain the same.



One measuring system for all amperages

Acquire alternating currents up to 4,000 A using a single coil type. Rogowski coils are available in three different lengths for optimum adjustment to the busbar and circular conductor dimensions.



Eight current measuring ranges

The measuring transducer connected downstream supplies the same typical secondary currents as a standard current transformer. Choose between eight different current measuring ranges via DIP switches. For optimum measuring accuracy, compensate for the different coil lengths by simply using a potentiometer.



Detect harmonics and transients

PACT RCP current transformers for retrofitting cover a large frequency range from 10 to 5,000 Hz. You can therefore measure harmonics and transients with phase accuracy.



UV protection for permanent outdoor use

The PACT RCP current transformer set is also available for outdoor use. The Rogowski coil of the UV version is equipped with a UV-resistant housing and UV-protected cables. This enables permanent installation outdoors.

Current transformers for retrofitting

PACT RCP

- Practical handling due to the flexible measuring coil for opening
- Universal application possibilities through 8 different current measuring ranges in one device: (0 ... 100/ ... / ... /4,000 A)
- The large bandwidth from 40 Hz to 20,000 Hz enables harmonics and transients to be detected
- It is not possible for dangerous open circuit voltages to occur
- The bracket ensures optimum alignment of the measuring coil to the power rail
- Low space requirement in the control cabinet



Current transformer for retrofitting in the field

ERIC

Technical data	
Measuring coil input data	
Frequency range	40 Hz ... 20,000 Hz
Measuring coil signal output	
Output signal (at 50 Hz)	100 mV (no load, at 1,000 A)
General data, measuring coil	
Rated insulation voltage	1,000 V AC (rms CAT III) 600 V AC (rms CAT IV)
Test voltage	10.45 kV (DC / 1 min.)
Ambient temperature (operation)	-30°C ... 80°C (measuring coil)
Ambient temperature (storage/transport)	-40°C ... 80°C (measuring coil)
Measuring transducer input data	
Measuring ranges (current) via DIP switch	100 A, 250 A, 400 A, 630 A, 1,000 A, 1,500 A, 2,000 A, 4,000 A
Phase angle	<1 °
Measuring transducer signal input	
Input signal (at 50 Hz)	100 mV (1,000 A)
Measuring transducer signal output	
Current output signal	0 A AC ... 1 A
Miscellaneous data for measuring transducer	
Nominal supply voltage	24 V DC -20% ... +25%
Nominal supply voltage range	19.2 V DC ... 30 V DC
Transmission error, maximum	≤0.5% (from the range end value)
Linearity error	<0.5% (from the range end value)
Frequency range	45 Hz ... 65 Hz
Maximum detectable harmonics	<2 kHz
Degree of protection	IP20
Test voltage	1.5 kV AC (supply/input and output: 50 Hz, 1 min)
Dimensions W/H/D	22.5 / 85 / 70.4 mm
Ambient temperature (operation)	-20°C ... 70°C (measuring transducer)
Ambient temperature (storage/transport)	-25°C ... 85°C (measuring transducer)
General data for the set	
Altitude	<2,000 m
Permissible humidity (operation)	5% ... 95% (non-condensing)
Approvals/conformities	
Standards/specifications	IEC 61010-1 IEC 61010-2-032

Recommendations for the use of coil lengths and busbar dimensions

Busbar	Diameter/ coil length	1 busbar per phase	2 busbars per phase	3 busbars per phase
[mm x mm]	[mm]			
30 x 10	95/300	✓	✓	
40 x 10	95/300	✓	✓	
40 x 10	140/450			✓
50 x 10	95/300	✓		
50 x 10	140/450		✓	✓
60 x 10	95/300	✓		
60 x 10	140/450		✓	✓
60 x 10	140/450	✓	✓	✓
100 x 10	140/450	✓	✓	
100 x 10	190/600			✓
120 x 10	140/450	✓		
120 x 10	190/600		✓	✓
160 x 10	190/600	✓	✓	✓

Description
Current transformer for retrofitting , set consisting of Rogowski coil and measuring transducer, output signal: 1 A AC (effective for sine) Length: measuring coil 300 mm, signal line 3 m
Length: measuring coil 300 mm, signal line 5 m
Length: measuring coil 300 mm, signal line 10 m
Length: measuring coil 450 mm, signal line 3 m
Length: measuring coil 450 mm, signal line 10 m
Length: measuring coil 600 mm, signal line 3 m
Length: measuring coil 600 mm, signal line 10 m

Holding device for power rail
for busbar thicknesses of 5 to 10 mm
for busbar thicknesses of 10 to 15 mm

Ordering data

Type	Order No.	Pcs./Pkt.
PACT RCP-4000A-1A-D95	2904921	1
PACT RCP-4000A-1A-D95-5M	2910325	1
PACT RCP-4000A-1A-D95-10M	2910326	1
PACT RCP-4000A-1A-D140	2904922	1
PACT RCP-4000A-1A-D140-10M	1033483	1
PACT RCP-4000A-1A-D190	2904923	1
PACT RCP-4000A-1A-D190-10M	2910327	1

Accessories

PACT RCP-CLAMP-5-10	2907888	1
PACT RCP-CLAMP	2904895	1

Current transformers for retrofitting

PACT RCP

- Universal application possibilities through 8 different current measuring ranges in one device: (0 ... 100/ ... / ... /4,000 A)
- Detection of harmonics and transients in the frequency range from 40 Hz to 20,000 Hz
- Large number of different standard signals on output side
- Freely configurable 4- way signal conditioner with switching output
- FASTCON Pro plug-in connection system
- Design width of just 6.2 mm
- Easy configuration e.g., via DIP switches, programmable software, via smartphone app or FDT/DTM



Current transformer
for retrofitting in the field

ERC

Technical data	
Measuring coil input data	
Frequency range	40 Hz ... 20,000 Hz
Measuring coil signal output	
Output signal (at 50 Hz)	100 mV (no load, at 1,000 A)
General data, measuring coil	
Length of signal cable	3000 mm
Rated insulation voltage	1,000 V AC (rms CAT III) 600 V AC (rms CAT IV) 10.45 kV (DC / 1 min.)
Test voltage	
Ambient temperature (operation)	-30°C ... 80°C (measuring coil)
Measuring transducer input data	
Measuring ranges (current) via DIP switch	100 A, 250 A, 400 A, 630 A, 1,000 A, 1,500 A, 2,000 A, 4,000 A
Measuring transducer signal input	
Input signal (at 50 Hz)	100 mV (1,000 A)
Measuring transducer signal output	
Current output signal	0 mA ... 20 mA (via DIP switch) 4 mA ... 20 mA (via DIP switch) 0 mA ... 10 mA (via DIP switch) 2 mA ... 10 mA (via DIP switch) 0 mA ... 21 mA (can be set via software)
Output signal	
Voltage	0 V ... 10 V (via DIP switch) 2 V ... 10 V (via DIP switch) 0 V ... 5 V (via DIP switch) 1 V ... 5 V (via DIP switch) 0 V ... 10.5 V (can be set via software)
Miscellaneous data for measuring transducer	
Nominal supply voltage	24 V DC
Nominal supply voltage range	9.6 V DC ... 30 V DC
Transmission error, maximum	≤0.5% (from the range end value)
Frequency range	16 Hz ... 1,000 Hz
Degree of protection	IP20
Test voltage	3 kV (50 Hz, 1 min.)
Dimensions W/H/D	6.2 / 110.5 / 120.5 mm
Ambient temperature (operation)	-40°C ... 70°C (measuring transducer)
General data for the set	
Altitude	>4,000 m
Permissible humidity (operation)	5% ... 95% (non-condensing)
Approvals/conformities	
Standards/specifications	IEC 61010-1 IEC 61010-2-032

Ordering data			
Description	Type	Order No.	Pcs./Pkt.
Current transformer with screw connection for retrofitting , set consisting of Rogowski coil and 4-way signal conditioner with switching output			
Length of measuring coil 300 mm	PACT RCP-4000A-UIRO-D95	2906231	1
Length of measuring coil 450 mm	PACT RCP-4000A-UIRO-D140	2906232	1
Length of measuring coil 600 mm	PACT RCP-4000A-UIRO-D190	2906233	1
Current transformer with Push-in connection in for retrofitting , set consisting of Rogowski coil and 4-way signal conditioner with switching output			
Length of measuring coil 300 mm	PACT RCP-4000A-UIRO-PT-D95	2906234	1
Length of measuring coil 450 mm	PACT RCP-4000A-UIRO-PT-D140	2906235	1
Length of measuring coil 600 mm	PACT RCP-4000A-UIRO-PT-D190	2906236	1

Accessories			
Description	Type	Order No.	Pcs./Pkt.
Holding device for power rail for busbar thicknesses of 5 to 10 mm	PACT RCP-CLAMP-5-10	2907888	1
for busbar thicknesses of 10 to 15 mm	PACT RCP-CLAMP	2904895	1

Current transformers for retrofitting

new

PACT RCP...-UV

- For permanent installation outdoors in the field
- UV-resistant Rogowski coil and UV-resistant cables
- Practical handling due to the flexible measuring coil for opening
- Universal application possibilities through 8 different current measuring ranges in one device: (0 ... 100/ ... / ... /4,000 A)
- The large bandwidth from 40 Hz to 20,000 Hz enables harmonics and transients to be detected
- It is not possible for dangerous open circuit voltages to occur
- The bracket ensures optimum alignment of the measuring coil to the power rail
- Low space requirement in the control cabinet



Current transformer for retrofitting in the field

ERIC

Technical data	
Measuring coil input data	
Frequency range	40 Hz ... 20,000 Hz
Measuring coil signal output	
Output signal (at 50 Hz)	100 mV (no load, at 1,000 A)
General data, measuring coil	
Rated insulation voltage	1,000 V AC (rms CAT III) 600 V AC (rms CAT IV) 10.45 kV (DC / 1 min.) IP67 (not assessed by UL)
Test voltage	-30°C ... 80°C (measuring coil)
Degree of protection	-
Ambient temperature (operation)	
Ambient temperature (storage/transport)	
Measuring transducer input data	
Measuring ranges (current) via DIP switch	100 A, 250 A, 400 A, 630 A, 1,000 A, 1,500 A, 2,000 A, 4,000 A
Phase angle	<1°
Measuring transducer signal input	
Input signal (at 50 Hz)	100 mV (1,000 A)
Measuring transducer signal output	
Current output signal	0 A AC ... 1 A
Miscellaneous data for measuring transducer	
Nominal supply voltage	24 V DC -20% ... +25%
Nominal supply voltage range	19.2 V DC ... 30 V DC
Transmission error, maximum	≤0.5% (from the range end value)
Linearity error	<0.5% (from the range end value)
Frequency range	45 Hz ... 65 Hz
Maximum detectable harmonics	<2 kHz
Degree of protection	IP20
Test voltage	1.5 kV AC (supply/input and output: 50 Hz, 1 min)
Dimensions W/H/D	22.5 / 85 / 70.4 mm
Ambient temperature (operation)	-20°C ... 70°C (measuring transducer)
Ambient temperature (storage/transport)	-
General data for the set	
Altitude	<2,000 m
Permissible humidity (operation)	5% ... 95% (non-condensing)
Approvals/conformities	
Standards/specifications	IEC 61010-1 IEC 61010-2-032

Description
Current transformer for retrofitting , set consisting of UV-resistant Rogowski coil and measuring transducer, output signal: 1 A AC (effective for sine)
Length: measuring coil 600 mm, signal line 3 m
Length: measuring coil 450 mm, signal line 3 m

Ordering data		
Type	Order No.	Pcs./Pkt.
PACT RCP-4000A-1A-D190-3M-UV	1033485	1
PACT RCP-4000A-1A-D140-3M-UV	1058044	1

Holding device for power rail
for busbar thicknesses of 5 to 10 mm
for busbar thicknesses of 10 to 15 mm

Accessories		
Type	Order No.	Pcs./Pkt.
PACT RCP-CLAMP-5-10	2907888	1
PACT RCP-CLAMP	2904895	1





With flexible power supply – current transducers up to 12 A AC

Active current transducers convert sinusoidal alternating currents up to 12 A. The integrated wide-range power supply unit enables use in various different countries.

With hinged Rogowski sensor – current transducers up to 200 A AC

The AC current transducers measure sinusoidal and non-sinusoidal alternating currents up to 200 A. The hinged Rogowski sensor ensures very easy installation, as cables that are to be measured do not have to be isolated. This enables mounting to be carried out without interruptions.

Limit value monitoring with the current protector

At the current protector, a desired amperage is specified at which a PDT contact switches a load on or off.

Flexible signal conditioning – current transducers up to 55 A AC/DC

Current transducers up to 55 A offer an infinitely adjustable measuring range. This range is mapped over the entire output signal range. This ensures extremely accurate resolution of measured values. Basic configuration can be performed quickly via the DIP switches. Additional useful device functions can be set via the software.

For high currents – current transducers up to 600 A AC/DC

The universal current transducers are the ideal solution for measuring high currents with any waveform up to 600 A AC/DC. The product range offers various different devices in graded measuring ranges with current or voltage output.



For sinusoidal alternating currents up to 12 A

- 3-way electrical isolation
- Wide-range version from 19.2 to 253 V AC/DC
- Voltage bridging with DIN rail connector
- Input and output can be configured via DIP switches
- Suitable for potentially explosive areas, thanks to ATEX approval for Ex zone 2



For sinusoidal and non-sinusoidal alternating currents up to 200 A

- Distorted alternating currents up to 6,000 Hz can be also acquired, thanks to true r.m.s. value measurement (RMS)
- Uninterrupted installation and lossless current measurement thanks to hinged Rogowski sensor
- Measuring range selection with slide switch



Limit value monitoring

The current protector converts sinusoidal alternating currents to binary switching signals.

- Switching point can be freely selected in the measuring range 0 to 16 A AC
- Changeover relay output
- Adjustable switch hysteresis
- 3-way isolation
- Settable operating current / quiescent current behavior



With flexible measuring ranges for all waveforms up to 55 A

- Lossless true r.m.s. value measurement without shunt via Hall sensor (TRMS)
- Optimum mapping of the measuring range up to 55 A, thanks to software-programmable upper and lower limits
- Limit value alarm in the event of threshold value overrange or underrange up to 55 A – via relay or transistor output



For high currents – current transducers up to 600 A AC/DC

- Lossless true r.m.s. value measurement without shunt via Hall sensor (TRMS)
- Compact dimensions also enable distributed use
- Variable mounting on DIN rail and mounting plate
- COMBICON plug-in connection terminal blocks
- 3-way isolation
- For a conductor diameter of up to 32 mm

Current measurement

Current transducers for AC, DC, and distorted currents

The **MCR-SL-CUC-...** current transducers measure DC, AC, and distorted currents from 0 to 600 A.

- Universal current measurement, no shunt required
- Compact dimensions also enable distributed use
- Variable mounting on DIN rail and mounting plate
- Simple connection method thanks to COMBICON plug-in connection terminal blocks
- 3-way isolation



For DC, AC, and distorted currents of 0 ... 300 A, voltage output



Housing width 90 mm

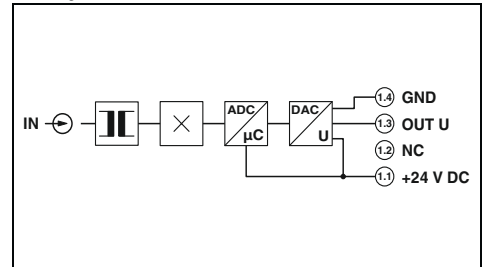

Technical data

Input data	
Frequency range	20 Hz ... 6,000 Hz (0 Hz)
Curve type	AC, DC or distorted currents
Connection method	Cable design: 32 mm diameter
Output data	
Output signal	0 ... 10 V
Maximum output signal	
Load R_B	≥ 10 k Ω
General data	
Supply voltage U_B	20 V DC ... 30 V DC
Maximum transmission error	$< \pm 1\%$ (of final value)
Temperature coefficient	Typically 0.02%/K (0 ... 60°C) 0.04%/K (-40°C ... 65°C)
Step response (10-90%)	150 ms
Safe isolation	In accordance with EN 61010
Rated insulation voltage	300 V AC
Surge voltage category/degree of pollution	III / 2
Degree of protection	IP20
Ambient temperature range	-40°C ... 65°C
Dimensions W/H/D	90 / 33.8 / 85 mm
Spring-cage connection (solid/stranded/AWG)	0.25 ... 2.5 mm ² / 0.2 ... 2.5 mm ² / 24 - 12
Conformance/approvals	
Conformance	CE-compliant
UL, USA/Canada	UL/C-UL listed UL 508

Ordering data

Description	Overload capacity	Type	Order No.	Pcs./Pkt.
Universal current transducer				
Input current range: 0 ... 100 A	6 x I_{IN}	MCR-SL-CUC-100-U	2308108	1
Input current range: 0 ... 200 A	3 x I_{IN}	MCR-SL-CUC-200-U	2308205	1
Input current range: 0 ... 300 A	3.33 x I_{IN}	MCR-SL-CUC-300-U	2308302	1
Input current range: 0 ... 400 A	2.5 x I_{IN}			
Universal current transducer without UL approval				
Input current range: 0 ... 500 A	3.6 x I_{IN}			
Input current range: 0 ... 600 A	3 x I_{IN}			



For DC, AC, and distorted currents
of 0 ... 600 A, current output



Housing width 90 mm

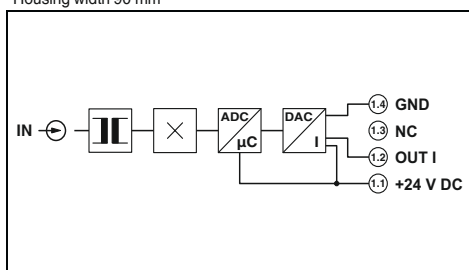

Technical data

20 Hz ... 6,000 Hz (0 Hz)
AC, DC or distorted currents
Cable design: 32 mm diameter

4 ... 20 mA
<25 mA
<300 Ω

20 V DC ... 30 V DC
<± 1% (of final value)
Typically 0.02%/K (0 ... 60°C) 0.04%/K (-40°C ... 65°C)

150 ms
In accordance with EN 61010
300 V AC
III / 2
IP20
-40°C ... 65°C
90 / 33.8 / 85 mm
0.25 ... 2.5 mm² / 0.2 ... 2.5 mm² / 24 - 12

CE-compliant
UL/C-UL listed UL 508

Ordering data

Type	Order No.	Pcs./Pkt.
MCR-SL-CUC-100-I	2308027	1
MCR-SL-CUC-200-I	2308030	1
MCR-SL-CUC-300-I	2308043	1
MCR-SL-CUC-400-I	2308072	1
MCR-SL-CUC-500-I	2308085	1
MCR-SL-CUC-600-I	2308098	1

Current transducers for AC, DC, and distorted currents

The **MCR-S...-UI(-SW)-DCI** current transducers measure direct, alternating and distorted currents.

- Device can be set via DIP switches or MCR/PI-CONF-WIN configuration software
- True r.m.s. value measurement
- 3-way isolation
- With optional relay and transistor output

Notes:

To order a configurable product, please enter the desired configuration using the order key, see page 232



For DC, AC, and distorted currents
0 ... 11 A



Ex:

Housing width 22.5 mm

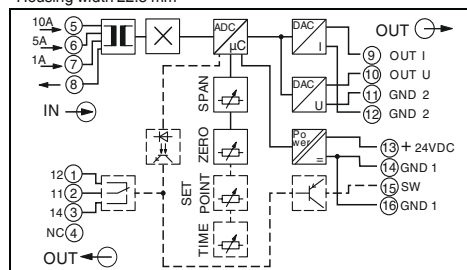

Technical data

Input data			0 A ... 11 A (AC/DC)
Input current			2% (of measuring range nominal value 1/5/10 A)
Response threshold			15 Hz ... 400 Hz
Frequency range			AC, DC or distorted currents
Curve type			2 x I _{N,continuous}
Overload capacity			20 x I _N (1 s)
Surge strength			Screw connection
Connection method			U output
Output data			I output
Output signal (normal and inverse)			0 ... 5 V / 1 ... 5 V / 0 ... 10 V
			0 ... 20 mA / 4 ... 20 mA
			2 ... 10 V / -5 ... 5 V / -10 ... 10 V
			>10 kΩ
			<500 Ω
Load R_B			
Switching output			
Relay output	Contact material		1 PDT / AgSnO, hard gold-plated
	Maximum switching current		50 mA (for gold layer, 30 V AC/ 36 V DC)
			2 A (in case of a destroyed gold layer, 250 V AC)
			19 V ... 29 V (supply voltage - 1 V)
Transistor output pnp	Output voltage		80 mA (not short-circuit proof)
	Continuous load current		1% ... 110%
			0.1 s ... 20 s
			Yellow LED
Setting range of the threshold value			
Response delay			
Status indication			
General data			
Supply voltage U _B			20 V DC ... 30 V DC
Current consumption			<50 mA (without load)
Maximum transmission error			<0.5% (of nominal range value under nominal conditions)
Temperature coefficient			Typically <0.025%/K
Step response (10-90%)			330 ms (with AC) 40 ms (with DC)
Safe isolation			In accordance with EN 50178, EN 61010
Rated insulation voltage			300 V AC (to earth)
Surge voltage category/degree of pollution			III / 2
Test voltage input/output			4 kV (50 Hz, 1 min.)
Test voltage input/power supply			4 kV (50 Hz, 1 min.)
Test voltage output/power supply			500 V (50 Hz, 1 min.)
Degree of protection			IP20
Dimensions W/H/D			22.5 / 99 / 114.5 mm
Screw connection rigid / flexible / AWG			0.2 ... 2.5 mm ² / 0.2 ... 2.5 mm ² / 24 - 14
EMC note			Class A product, see page 583
Conformance/approvals			
Conformance			CE-compliant
UL, USA/Canada			Class I, Zone 2, AEx nA nC IIC T4, Ex nA nC IIC T4 Gc X

Ordering data

Description	Type	Order No.	Pcs./Pkt.
MCR current measuring transducer for measuring AC, DC, and distorted currents with relay and transistor switching output			
Configurable product	MCR-S-1-5-UI-SW-DCI	2814650	1
Standard product	MCR-S-1-5-UI-SW-DCI-NC	2814731	1
Configurable product, without switching output	MCR-S-1-5-UI-DCI	2814634	1
Standard product, without switching output	MCR-S-1-5-UI-DCI-NC	2814715	1



For DC, AC, and distorted currents
0 ... 55 A



For DC, AC, and distorted currents
0 to 100 A

Ex:
Housing width 22.5 mm

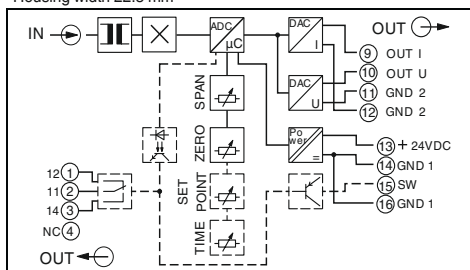

Technical data

-
0.8% (of measuring range nominal value 50 A)
15 Hz ... 400 Hz
AC, DC or distorted currents
Depending on through connected conductor
Depending on through connected conductor
Through connection, diameter 10.5 mm

U output	I output
0 ... 5 V / 1 ... 5 V / 0 ... 10 V	0 ... 20 mA / 4 ... 20 mA
2 ... 10 V / -5 ... 5 V / -10 ... 10 V	
>10 kΩ	<500 Ω

1 PDT / AgSnO, hard gold-plated
50 mA (for gold layer, 30 V AC / 36 V DC)
2 A (in case of a destroyed gold layer, 250 V AC)
19 V ... 29 V (supply voltage - 1 V)
80 mA (not short-circuit proof)
1% ... 110%
0.1 s ... 20 s
Yellow LED

20 V DC ... 30 V DC
<50 mA (without load)
<0.5% (of nominal range value under nominal conditions)
Typically <0.025%/K
330 ms (with AC) 40 ms (with DC)
In accordance with EN 50178, EN 61010
300 V AC (to earth)
III / 2
4 kV (50 Hz, 1 min.)
4 kV (50 Hz, 1 min.)
500 V (50 Hz, 1 min.)
IP20
22.5 / 99 / 114.5 mm
0.2 ... 2.5 mm² / 0.2 ... 2.5 mm² / 24 - 14
Class A product, see page 583

CE-compliant
Class I, Zone 2, AEx nA nC IIC T4, Ex nA nC IIC T4 Gc X

Ordering data

Type	Order No.	Pcs./Pkt.
MCR-S-10-50-UI-SW-DCI	2814663	1
MCR-S10-50-UI-SW-DCI-NC	2814744	1
MCR-S-10-50-UI-DCI	2814647	1
MCR-S10-50-UI-DCI-NC	2814728	1

Ex:
Housing width 22.5 mm

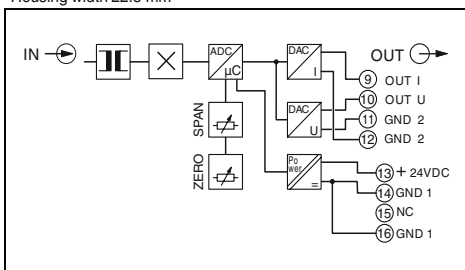

Technical data

0 A AC ... 100 A AC (± 100 A DC)
1% (of measuring range nominal value 100 A)
15 Hz ... 400 Hz
AC, DC or distorted currents
Depending on through connected conductor
Depending on through connected conductor
Through connection, diameter 10.5 mm

U output	I output
0 ... 5 V / 1 ... 5 V / 0 ... 10 V	0 ... 20 mA / 4 ... 20 mA
2 ... 10 V / -5 ... 5 V / -10 ... 10 V	
>10 kΩ	<500 Ω

- / -
-
-
-
-
-

20 V DC ... 30 V DC
<40 mA (without load)
<0.5% (of nominal range value under nominal conditions)
Typically <0.025%/K
330 ms (AC) 40 ms (DC)
In accordance with EN 50178, EN 61010
300 V AC (to earth)
III / 2
4 kV (50 Hz, 1 min.)
4 kV (50 Hz, 1 min.)
500 V (50 Hz, 1 min.)
IP20
22.5 / 99 / 114.5 mm
0.2 ... 2.5 mm² / 0.2 ... 2.5 mm² / 24 - 14
Class A product, see page 583

CE-compliant
Class I, Zone 2, AEx nA nC IIC T4, Ex nA nC IIC T4 Gc X

Ordering data

Type	Order No.	Pcs./Pkt.
MCR-S-20-100-UI-DCI	2908798	1

Monitoring

Current measurement

Order key for current transducers (standard configuration entered as an example)

Order No.	Measuring range:		Output	Threshold value	Suppression time	Switching behavior of relay and transistor	
	Start	End					
2814634	0.00	5.00	OUT01				
2814650	0.00	5.00	OUT01	50	3.0	A	O
2814634 ≙ MCR-S-1-5-UI-DCI	Measuring range initial value between	Measuring range final value between	OUT01 ≙ 0 ... 20 mA OUT02 ≙ 4 ... 20 mA OUT03 ≙ 0 ... 10 V OUT04 ≙ 2 ... 10 V OUT05 ≙ 0 ... 5 V OUT06 ≙ 1 ... 5 V OUT07 ≙ 20 ... 0 mA OUT08 ≙ 20 ... 4 mA OUT09 ≙ 10 ... 0 V OUT10 ≙ 10 ... 2 V OUT11 ≙ 5 ... 0 V OUT12 ≙ 5 ... 1 V OUT13 ≙ -5 ... +5 V OUT14 ≙ -10 ... +10 V OUT17 ≙ +10 ... -10 V OUT18 ≙ +5 ... -5 V	Switching threshold between 1 ... 110% 50 ≙ 50% of the set measuring range final value (here 2.5 A)	between 0.1 ... 20 s 3.0 ≙ 3 s	A ≙ Operating- current- controlled R ≙ Closed- circuit- current- controlled	O ≙ Over-range U ≙ Under-range
2814650 ≙ MCR-S-1-5-UI-SW-DCI	0.00 ... 7.50 A 0.00 ≙ 0.00 A	0.2 ... 11 A 5.00 ≙ 5.00 A					

Order No.	Measuring range:		Output	Threshold value	Suppression time	Switching behavior of relay and transistor	
	Start	End					
2814647	0.0	50.0	OUT01				
2814663	0.0	50.0	OUT01	50	3.0	A	O
2814647 ≙ MCR-S-10-50-UI-DCI	Measuring range initial value between	Measuring range final value between	OUT01 ≙ 0 ... 20 mA OUT02 ≙ 4 ... 20 mA OUT03 ≙ 0 ... 10 V OUT04 ≙ 2 ... 10 V OUT05 ≙ 0 ... 5 V OUT06 ≙ 1 ... 5 V OUT07 ≙ 20 ... 0 mA OUT08 ≙ 20 ... 4 mA OUT09 ≙ 10 ... 0 V OUT10 ≙ 10 ... 2 V OUT11 ≙ 5 ... 0 V OUT12 ≙ 5 ... 1 V OUT13 ≙ -5 ... +5 V OUT14 ≙ -10 ... +10 V OUT17 ≙ +10 ... -10 V OUT18 ≙ +5 ... -5 V	Switching threshold between 1 ... 110% 50 ≙ 50% of the set measuring range final value (here 25 A)	between 0.1 ... 20 s 3.0 ≙ 3 s	A ≙ Operating- current- controlled R ≙ Closed- circuit- current- controlled	O ≙ Over-range U ≙ Under-range
2814663 ≙ MCR-S-10-50-UI-SW-DCI	0.0 ... 37.5 A 0.0 ≙ 0.0 A	9.5 ... 55 A 50.0 ≙ 50.0 A					

Order No.	Measuring range:		Output
	Start	End	
2908798	0.0	100.0	OUT01
2908798 ≙ MCR-S-20-100-UI-DCI	Measuring range initial value between	Measuring range final value between	OUT01 ≙ 0 ... 20 mA OUT02 ≙ 4 ... 20 mA OUT03 ≙ 0 ... 10 V OUT04 ≙ 2 ... 10 V OUT05 ≙ 0 ... 5 V OUT06 ≙ 1 ... 5 V OUT07 ≙ 20 ... 0 mA OUT08 ≙ 20 ... 4 mA OUT09 ≙ 10 ... 0 V OUT10 ≙ 10 ... 2 V OUT11 ≙ 5 ... 0 V OUT12 ≙ 5 ... 1 V OUT13 ≙ -5 ... +5 V OUT14 ≙ -10 ... +10 V OUT17 ≙ +10 ... -10 V OUT18 ≙ +5 ... -5 V
	0.0 ... 75 A 0.0 ≙ 0.0 A	19 ... 110 A 100 ≙ 100 A	

Function chart: switching behavior of relay and transistor output:

1) Operating-current-controlled when above the threshold value (TV)

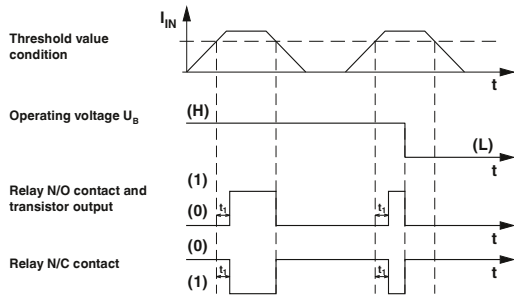

2) Operating-current-controlled when below the threshold value (TV)

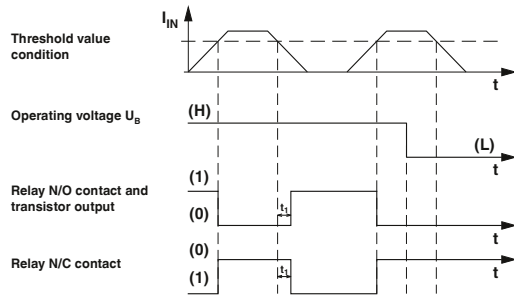

3) Closed-circuit-current-controlled when above the threshold value (TV)

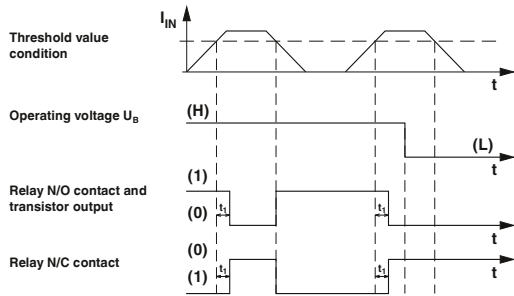

4) Closed-circuit-current-controlled when below the threshold value (TV)

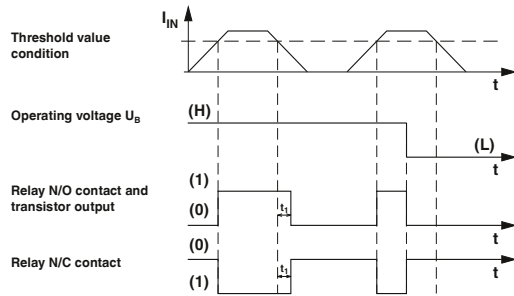

(0) ≙ N/O contact and transistor open / N/C contact closed
 (1) ≙ N/O contact and transistor closed / N/C contact open

Monitoring

Current measurement

AC current transducers, sinusoidal

The **MCR-SL-CAC-...** current transducers measure sinusoidal alternating currents from 0 to 1/5/12 A.

- Wide range version from 19.2 to 253 V AC/DC
- 3-way isolation
- Input and output can be configured via DIP switches



For sinusoidal alternating currents
0 ... 1 A/0 ... 5 A



For sinusoidal alternating currents
0 ... 5 A/0 ... 12 A

ERAC
Ex:
Housing width 22.5 mm

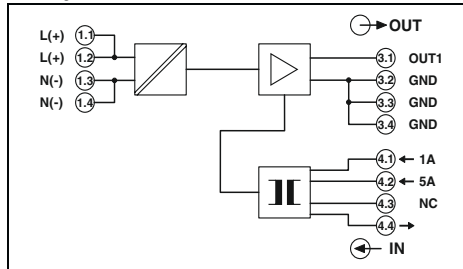

Technical data

Input data	0 A AC ... 1 A (configurable) / 0 A AC ... 5 A (configurable)	
Input current (configurable)		
Nominal frequency	50 Hz	
Frequency range	45 Hz ... 65 Hz	
Curve type	Sine	
Overload capacity	2 x I _N (continuous)	
Surge strength	20 x I _N (1 s)	
Connection method	Screw terminal block	
Output data	0 ... 20 mA / 4 ... 20 mA	
Output signal (configurable)	0 ... 20 mA	
Maximum output signal	25 mA	
Load R _B	<500 Ω (at 20 mA)	
Ripple	<10 mV _{pp} (for 500 Ω at 20 mA)	
General data	MACX MCR-SL-CAC- 5-I	MACX MCR-SL-CAC- 5-I-UP
Supply voltage U _B	19.2 V DC ... 30 V DC	19.2 V AC/DC ... 253 V AC/DC
Current consumption	<32 mA (at U _B =24 V DC, I _{OUT} =20 mA)	<30 mA (at U _B =24 V DC, I _{OUT} =20 mA)
Maximum transmission error	≤0.5% (of nominal range value under nominal conditions)	≤0.5% (of nominal range value under nominal conditions)
Temperature coefficient	<0.02%/K	<0.02%/K
Step response (10-90%)	Max. 300 ms typically 200 ms	Max. 300 ms typically 200 ms
Safe isolation	In accordance with EN 61010	In accordance with EN 61010
Rated insulation voltage	-	-
Overvoltage category Input/output	-	-
Degree of pollution	2	2
Test voltage input/output	4 kV (50 Hz, 1 min.)	4 kV (50 Hz, 1 min.)
Test voltage output/power supply	1.5 kV (50 Hz, 1 min.)	2 kV (50 Hz, 1 min.)
Degree of protection	IP20	IP20
Ambient temperature range	-20°C ... 65°C (-4°F...149°F)	-20°C ... 65°C (-4°F...149°F)
Dimensions W/H/D	22.5 / 104 / 114.5 mm	22.5 / 104 / 114.5 mm
Screw connection rigid / flexible / AWG	0.2 ... 2.5 mm ² / 0.2 ... 2.5 mm ² / 24 - 14	0.2 ... 2.5 mm ² / 0.2 ... 2.5 mm ² / 24 - 14
EMC note	Class A product, see page 583	
Conformance/approvals	CE-compliant	
Conformance	II 3 G Ex nA IIC T4 Gc X	
UL, USA/Canada	UL 508 Recognized	

ERAC
Ex:
Housing width 22.5 mm

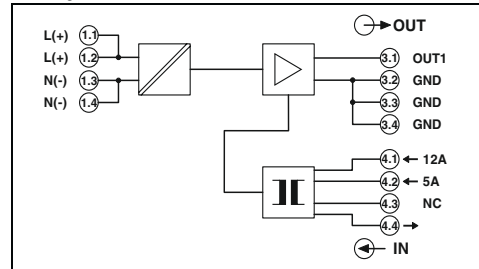

Technical data

Input data	0 A AC ... 5 A (configurable) / 0 A AC ... 12 A (configurable)	
Input current (configurable)		
Nominal frequency	50 Hz	
Frequency range	45 Hz ... 65 Hz	
Curve type	Sine	
Overload capacity	1 x I _N (continuous)	
Surge strength	8 x I _N (1 s)	
Connection method	Screw terminal block	
Output data	0 ... 20 mA / 4 ... 20 mA	
Output signal (configurable)	0 ... 20 mA	
Maximum output signal	25 mA	
Load R _B	<500 Ω (at 20 mA)	
Ripple	<10 mV _{pp} (for 500 Ω at 20 mA)	
General data	MACX MCR-SL-CAC-12-I-UP	
Supply voltage U _B	19.2 V AC/DC ... 253 V AC/DC	-
Current consumption	<33 mA (at 24 V DC)	-
Maximum transmission error	≤0.5% (of nominal range value under nominal conditions)	-
Temperature coefficient	<0.02%/K	-
Step response (10-90%)	<300 ms	-
Safe isolation	In accordance with EN 61010	-
Rated insulation voltage	300 V AC (to earth)	-
Overvoltage category Input/output	III	-
Degree of pollution	2	-
Test voltage input/output	4 kV (50 Hz, 1 min.)	-
Test voltage output/power supply	2 kV (50 Hz, 1 min.)	-
Degree of protection	IP20	-
Ambient temperature range	-20°C ... 65°C (-4°F...149°F)	-
Dimensions W/H/D	22.5 / 104 / 114.5 mm	- / - / -
Screw connection rigid / flexible / AWG	0.2 ... 2.5 mm ² / 0.2 ... 2.5 mm ² / 24 - 14	- ... - / - ... - / -
EMC note	Class A product, see page 583	
Conformance/approvals	CE-compliant	
Conformance	II 3 G Ex nA IIC T4 Gc X	
UL, USA/Canada	-	

Ordering data

Description	Type	Order No.	Pcs./Pkt.
MCR current measuring transducers for sinusoidal alternating currents			
Supply voltage 19.2 ... 30 V DC	MACX MCR-SL-CAC- 5-I	2810612	1
Supply voltage 19.2 ... 253 V AC/DC	MACX MCR-SL-CAC- 5-I-UP	2810625	1

Accessories

Description	Type	Order No.	Pcs./Pkt.
DIN rail connector , for bridging the supply voltage (19.2...30 V DC), can be snapped on to 35 mm DIN rails as per EN 60715	ME 22,5 TBUS 1,5/ 5-ST-3,81 GN	2707437	50

Ordering data

Description	Type	Order No.	Pcs./Pkt.
MCR current measuring transducers for sinusoidal alternating currents			
Supply voltage 19.2 ... 253 V AC/DC	MACX MCR-SL-CAC-12-I-UP	2810638	1

Accessories

Description	Type	Order No.	Pcs./Pkt.

AC current transducers, sinusoidal and distorted

The **MCR-SL-S-...00-...** current transducers measure sinusoidal and non-sinusoidal alternating currents within the range 0 to 200 A.

- 30 to 6,000 Hz true r.m.s. value measurement
- Measuring range selection with slide switch
- Loop-powered
- Can be retrofitted with the open-up Rogowski coil

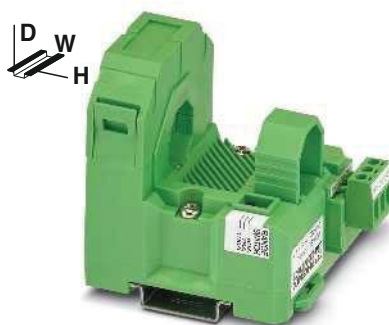

For sinusoidal and non-sinusoidal alternating currents, 0 ... 200 A, voltage output

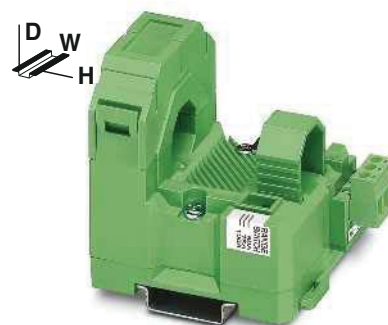

For sinusoidal and non-sinusoidal alternating currents, 0 ... 200 A, current output (loop-powered)

EAC
Housing width 55 mm

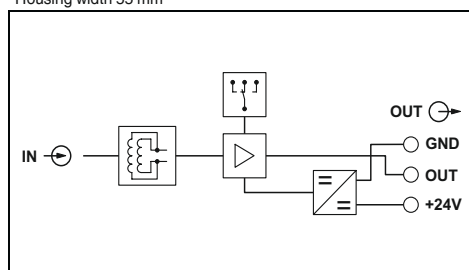

Technical data

Input data	...-S-100-U	...-S-200-U
Input current (configurable)	0 A ... 100 A (0 ... 50/75/100 A)	0 A ... 200 A (0 ... 100/150/200 A)
Response threshold	1% (of final value)	1% (of final value)
Frequency range	30 Hz ... 6,000 Hz	30 Hz ... 6,000 Hz
Curve type	Sinusoidal and non-sinusoidal	
Overload capacity	Depending on laid conductor	
Surge strength	Depending on through connected conductor	
Connection method	-	
Output data		
Output signal	0 ... 5 V / 0 ... 10 V	
Maximum output signal	(0 V ... 10 V) 14 V, (0 V ... 5 V) 7 V	
Load R_B	≥ 10 k Ω	
General data		
Supply voltage U_B	20 V DC ... 30 V DC	
Current consumption	<30 mA	
Maximum transmission error	<1% (of final value)	
Cable position error	<0.63%	
Temperature coefficient	<0.035%/K	
Step response (10-90%)	<340 ms	
Safe isolation	In accordance with IEC 61010-1 and IEC 61326	
Rated insulation voltage	300 V AC (to earth)	
Surge voltage category/degree of pollution	III / 2	
Test voltage input/output	5 kV (50 Hz, 1 min.)	
Degree of protection	IP20	
Ambient temperature range	-20°C ... 60°C	
Dimensions W/H/D	55 / 85 / 70.5 mm	
Screw connection rigid / flexible / AWG	0.2 ... 2.5 mm ² / 0.2 ... 2.5 mm ² / 24 - 14	
Conformance/approvals	CE-compliant UL/C-UL listed UL 508	

EAC
Housing width 55 mm

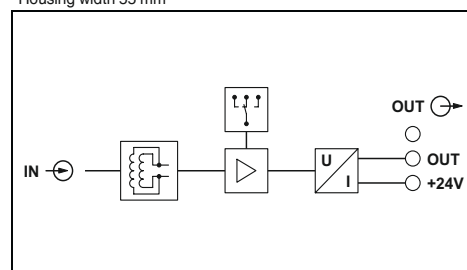

Technical data

Input data	...-S-100-I-LP	...-S-200-I-LP
Input current (configurable)	0 A ... 100 A (0 ... 50/75/100 A)	0 A ... 200 A (0 ... 100/150/200 A)
Response threshold	1% (of final value)	1% (of final value)
Frequency range	30 Hz ... 6,000 Hz	30 Hz ... 6,000 Hz
Curve type	Sinusoidal and non-sinusoidal	
Overload capacity	Depending on laid conductor	
Surge strength	Depending on through connected conductor	
Connection method	-	
Output data		
Output signal	4 ... 20 mA	
Maximum output signal	<25 mA	
Load R_B	$(U_B - 12$ V) x 350 / 12 A	
General data		
Supply voltage U_B	20 V DC ... 30 V DC	
Current consumption	<30 mA	
Maximum transmission error	<1% (of final value)	
Cable position error	<0.63%	
Temperature coefficient	<0.025%/K	
Step response (10-90%)	<340 ms	
Safe isolation	In accordance with IEC 61010-1 and IEC 61326	
Rated insulation voltage	300 V AC (to earth)	
Surge voltage category/degree of pollution	III / 2	
Test voltage input/output	5 kV (50 Hz, 1 min.)	
Degree of protection	IP20	
Ambient temperature range	-20°C ... 60°C	
Dimensions W/H/D	55 / 85 / 70.5 mm	
Screw connection rigid / flexible / AWG	0.2 ... 2.5 mm ² / 0.2 ... 2.5 mm ² / 24 - 14	
Conformance/approvals	CE-compliant UL/C-UL listed UL 508	

Ordering data

Description	Type	Order No.	Pcs./Pkt.
MCR current measuring transducers for sinusoidal and non-sinusoidal alternating currents Input current range: 0...50/75/100 A Input current range: 0..0.100/150/200 A	MCR-SL-S-100-U	2813457	1
	MCR-SL-S-200-U	2813460	1

Ordering data

Description	Type	Order No.	Pcs./Pkt.
MCR current measuring transducers for sinusoidal and non-sinusoidal alternating currents Input current range: 0...50/75/100 A Input current range: 0..0.100/150/200 A	MCR-SL-S-100-I-LP	2813486	1
	MCR-SL-S-200-I-LP	2813499	1

Monitoring

Current measurement

Passive AC current transducers, sinusoidal

The **MCR-SLP-1-5-UI-0** passive current transducer measures sinusoidal alternating currents within the range from 0 to 1 A/ 0 to 5 A.

- Loop-powered
- Measuring ranges 1 and 5 A AC reconnectable



For sinusoidal alternating currents
0 ... 1 A/0 ... 5 A

PHOENIX CONTACT
Housing width 22.5 mm

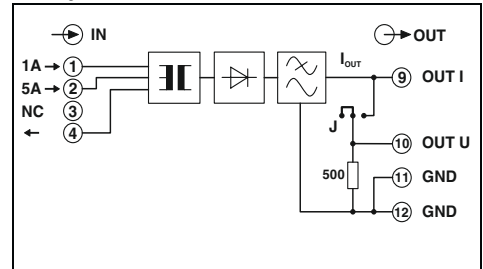

Technical data

	1 A input	5 A input
Input current	0 A AC ... 1 A	0 A AC ... 5 A
Frequency range	45 Hz ... 60 Hz	45 Hz ... 60 Hz
Curve type	Sine	Sine
Overload capacity	2 x I _N (5 min. at 60°C ambient temperature)	2 x I _N (5 min. at 60°C ambient temperature)
Surge strength	50 A (1 s)	100 A (1 s)
Permissible output range	1.2 x I _N	1.2 x I _N
Connection method	Screw connection	Screw connection
Output data	U output	I output
Output signal	0 ... 10 V	0 ... 20 mA
Maximum output signal	20 V	30 mA
Load R _B	>100 kΩ	<750 Ω <250 Ω (when current and voltage outputs are used simultaneously)
Ripple	<50 mV _{pp}	<50 mV _{pp}
General data	Maximum transmission error <0.5% (of final value) Temperature coefficient <0.015%/K Step response (10-90%) <200 ms Safe isolation In accordance with EN 50178, EN 61010 Rated insulation voltage 300 V AC (to earth) Surge voltage category/degree of pollution III / 2 Degree of protection IP20 Ambient temperature range -25°C ... 60°C Dimensions W/H/D 22.5 / 99 / 114.5 mm Screw connection rigid / flexible / AWG 0.2 ... 2.5 mm ² / 0.2 ... 2.5 mm ² / 24 - 14 EMC note Class A product, see page 583	
Conformance/approvals	CE-compliant	

Ordering data

Description	Type	Order No.	Pcs./Pkt.
MCR passive current measuring transducers for sinusoidal alternating currents	MCR-SLP-1-5-UI-0	2814359	1

AC current protectors, sinusoidal

The **MCR-SL-S-16-SP-24** current protector converts sinusoidal 50 Hz/60 Hz alternating currents into binary switching signals.

- Switching point can be freely selected in the measuring range of 0 to 16 A AC
- Changeover relay output
- Adjustable switch hysteresis
- 3-way isolation
- Settable operating current / quiescent current behavior



For sinusoidal alternating currents,
0 ... 16 A AC



Housing width 22.5 mm

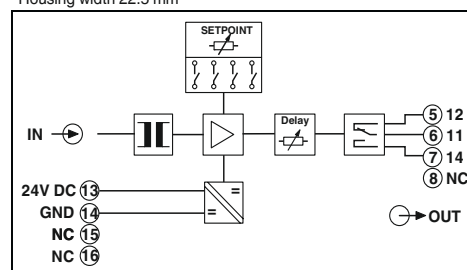

Technical data

Input data		
Input current	0 A AC ... 16 A	
Frequency range	45 Hz ... 65 Hz	
Curve type	Sine	
Overload capacity	2 x I _N (continuous)	
Connection method	-	
Switching output		
Contact type	1 PDT	
Contact material	AgSnO, hard gold-plated	
Max. switching current	50 mA (for gold layer, 30 V AC/ 36 V DC) 2 A (in case of a destroyed gold layer, 250 V AC)	
Switching hysteresis	Adjustable using a DIP switch (0.5%, 5%, 10%, 15%)	
Response delay	Typically 0.1 s ... 10 s (adjustable using a potentiometer)	
Operating and closed circuit current behavior	Adjustable using a DIP switch	
Relay status display	Yellow LED (relay active)	
General data		
Supply voltage U _B	20 V DC ... 30 V DC	
Current consumption	<30 mA	
Setting accuracy	<0.5%	
Temperature coefficient	<0.02%/K	
Step response (10-90%)	40 ms	
Safe isolation	acc. to EN 50178, EN 61010-1	
Rated insulation voltage	300 V AC (to earth)	
Surge voltage category/degree of pollution	III / 2	
Test voltage input/output	3.5 kV (50 Hz, 1 min.)	
Test voltage input/power supply	3.5 kV (50 Hz, 1 min.)	
Degree of protection	IP20	
Ambient temperature range	-20°C ... 65°C	
Dimensions W/H/D	22.5 / 99 / 114.5 mm	
Screw connection rigid / flexible / AWG	0.2 ... 2.5 mm ² / 0.2 ... 2.5 mm ² / 24 - 14	
EMC note	Class A product, see page 583	
Conformance/approvals		
Conformance	CE-compliant	
Ordering data		
Description		
MCR current protector for sinusoidal alternating currents		
Type	Order No.	Pcs./Pkt.
MCR-SL-S- 16-SP- 24	2864464	1

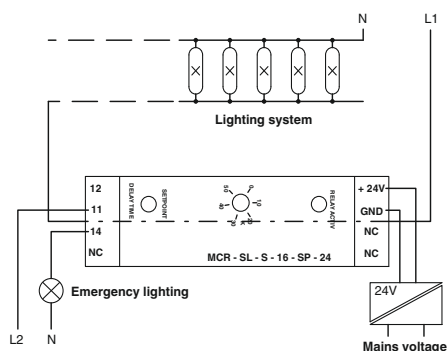

Lighting system with emergency lighting

Monitoring

Current measurement

Voltage transducers

The MACX MCR-VDC voltage transducer measures DC voltages within the range of 0 to ± 660 V DC. The MACX MCR-VAC module measures sinusoidal AC voltages from 0 to 660 V AC.

- Bidirectional output signals
- 9 voltage measuring ranges
- Voltage measuring ranges can be freely adjusted
- ZERO/SPAN adjustment $\pm 20\%$
- 3-way isolation

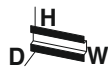

For DC voltages from 0 to ± 660 V DC



For sinusoidal AC voltages 0 ... 660 V AC

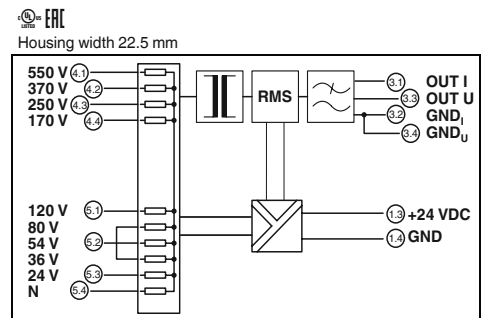
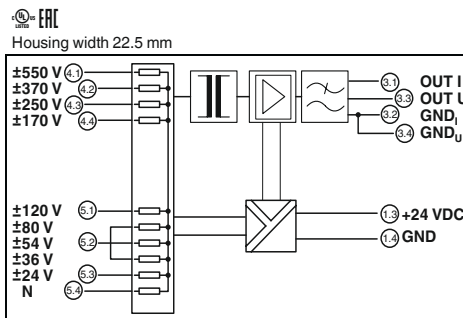

Technical data																			
Input data																			
Input voltage range / resistor	<table border="1"> <tr><td>± 550 V DC ... 550 V DC</td><td>5,500 kΩ</td></tr> <tr><td>± 370 V DC ... 370 V DC</td><td>3,700 kΩ</td></tr> <tr><td>± 250 V DC ... 250 V DC</td><td>2,500 kΩ</td></tr> <tr><td>± 170 V DC ... 170 V DC</td><td>1,700 kΩ</td></tr> <tr><td>± 120 V DC ... 120 V DC</td><td>1,200 kΩ</td></tr> <tr><td>± 80 V DC ... 80 V DC</td><td>800 kΩ</td></tr> <tr><td>± 54 V DC ... 54 V DC</td><td>800 kΩ</td></tr> <tr><td>± 36 V DC ... 36 V DC</td><td>800 kΩ</td></tr> <tr><td>± 24 V DC ... 24 V DC</td><td>240 kΩ</td></tr> </table>	± 550 V DC ... 550 V DC	5,500 k Ω	± 370 V DC ... 370 V DC	3,700 k Ω	± 250 V DC ... 250 V DC	2,500 k Ω	± 170 V DC ... 170 V DC	1,700 k Ω	± 120 V DC ... 120 V DC	1,200 k Ω	± 80 V DC ... 80 V DC	800 k Ω	± 54 V DC ... 54 V DC	800 k Ω	± 36 V DC ... 36 V DC	800 k Ω	± 24 V DC ... 24 V DC	240 k Ω
± 550 V DC ... 550 V DC	5,500 k Ω																		
± 370 V DC ... 370 V DC	3,700 k Ω																		
± 250 V DC ... 250 V DC	2,500 k Ω																		
± 170 V DC ... 170 V DC	1,700 k Ω																		
± 120 V DC ... 120 V DC	1,200 k Ω																		
± 80 V DC ... 80 V DC	800 k Ω																		
± 54 V DC ... 54 V DC	800 k Ω																		
± 36 V DC ... 36 V DC	800 k Ω																		
± 24 V DC ... 24 V DC	240 k Ω																		
ZERO / SPAN adjustment	$\pm 20\%$ / $\pm 20\%$																		
Frequency range	-																		
Maximum input voltage	± 660 V DC																		
Output data																			
Output signal	U output I output																		
Maximum output signal	$-10 \dots 10$ V $-20 \dots 20$ mA																		
Load R_B	≤ 11 V ≤ 22 mA																		
Ripple	> 10 k Ω < 500 Ω																		
General data																			
Supply voltage U_B	19.2 V DC ... 30 V DC																		
Current consumption	< 60 mA																		
Maximum transmission error	$< 1\%$ (of measuring range end value)																		
Temperature coefficient	$< 0.015\%/K$																		
Step response (10-90%)	< 16 ms																		
Safe isolation	In accordance with IEC 61010-1																		
Degree of pollution	2																		
Degree of protection	IP20																		
Dimensions W/H/D	22.5 / 99 / 114.5 mm																		
Connection data solid/stranded/AWG	0.2 ... 2.5 mm ² / 0.2 ... 2.5 mm ² / 24 - 14																		
Conformance/approvals																			
Conformance	CE-compliant																		
UL, USA/Canada	UL 61010 Listed																		

Technical data																			
Input data																			
Input voltage range / resistor	<table border="1"> <tr><td>0 V ... 550 V AC</td><td>5,500 kΩ</td></tr> <tr><td>0 V ... 370 V AC</td><td>3,700 kΩ</td></tr> <tr><td>0 V ... 250 V AC</td><td>2,500 kΩ</td></tr> <tr><td>0 V ... 170 V AC</td><td>1,700 kΩ</td></tr> <tr><td>0 V ... 120 V AC</td><td>1,200 kΩ</td></tr> <tr><td>0 V ... 80 V AC</td><td>800 kΩ</td></tr> <tr><td>0 V ... 54 V AC</td><td>800 kΩ</td></tr> <tr><td>0 V ... 36 V AC</td><td>800 kΩ</td></tr> <tr><td>0 V ... 24 V AC</td><td>240 kΩ</td></tr> </table>	0 V ... 550 V AC	5,500 k Ω	0 V ... 370 V AC	3,700 k Ω	0 V ... 250 V AC	2,500 k Ω	0 V ... 170 V AC	1,700 k Ω	0 V ... 120 V AC	1,200 k Ω	0 V ... 80 V AC	800 k Ω	0 V ... 54 V AC	800 k Ω	0 V ... 36 V AC	800 k Ω	0 V ... 24 V AC	240 k Ω
0 V ... 550 V AC	5,500 k Ω																		
0 V ... 370 V AC	3,700 k Ω																		
0 V ... 250 V AC	2,500 k Ω																		
0 V ... 170 V AC	1,700 k Ω																		
0 V ... 120 V AC	1,200 k Ω																		
0 V ... 80 V AC	800 k Ω																		
0 V ... 54 V AC	800 k Ω																		
0 V ... 36 V AC	800 k Ω																		
0 V ... 24 V AC	240 k Ω																		
ZERO / SPAN adjustment	$\pm 20\%$ / $\pm 20\%$																		
Frequency range	45 Hz ... 405 Hz																		
Maximum input voltage	± 660 V AC																		
Output data																			
Output signal	U output I output																		
Maximum output signal	$0 \dots 10$ V / $2 \dots 10$ V $0 \dots 20$ mA / $4 \dots 20$ mA																		
Load R_B	≤ 11 V ≤ 22 mA																		
Ripple	> 10 k Ω < 500 Ω																		
General data																			
Supply voltage U_B	19.2 V DC ... 30 V DC																		
Current consumption	< 45 mA																		
Maximum transmission error	$< 1\%$ (from a measuring range final value, 45 ... 65 Hz)																		
Temperature coefficient	$< 0.015\%/K$																		
Step response (10-90%)	< 180 ms																		
Safe isolation	In accordance with EN 50178																		
Degree of pollution	2																		
Degree of protection	IP20																		
Dimensions W/H/D	22.5 / 99 / 114.5 mm																		
Connection data solid/stranded/AWG	0.2 ... 2.5 mm ² / 0.2 ... 2.5 mm ² / 24 - 14																		
Conformance/approvals																			
Conformance	CE-compliant																		
UL, USA/Canada	UL 61010 Listed																		

Ordering data	
Description	
MCR-voltage transducer, for DC voltages from 0 to ± 20 V DC to 0 to ± 660 V DC	
- with screw connection	
- with Push-in connection	
MCR voltage transducer, for sinusoidal AC voltages from 0 to 20 V AC to 0 to 660 V AC	
- with screw connection	
- with Push-in connection	
Type	Order No. Pcs./Pkt.
MACX MCR-VDC	2906242 1
MACX MCR-VDC-PT	2906243 1

Ordering data	
Type	Order No. Pcs./Pkt.
MACX MCR-VAC	2906239 1
MACX MCR-VAC-PT	2906244 1

USB adapter cables

Software adapter cables

The following adapter cables are available for programming the MCR-S... current transducers:

- USB adapter cable
- Software adapter cable



For MCR-S... current transducer

ERC

		Ordering data		
Description	Type	Order No.	Pcs./Pkt.	
USB adapter cable, D-9-SUB to USB, with adapter D-9-SUB to D-25-SUB	CM-KBL-RS232/USB	2881078	1	
Software adapter cable (stereo jack plug/25-pos. D-SUB), 1.2 m long, for programming MCR-T-..., MCR-S-..., and MCR-F-... modules	MCR-TTL-RS232-E	2814388	1	

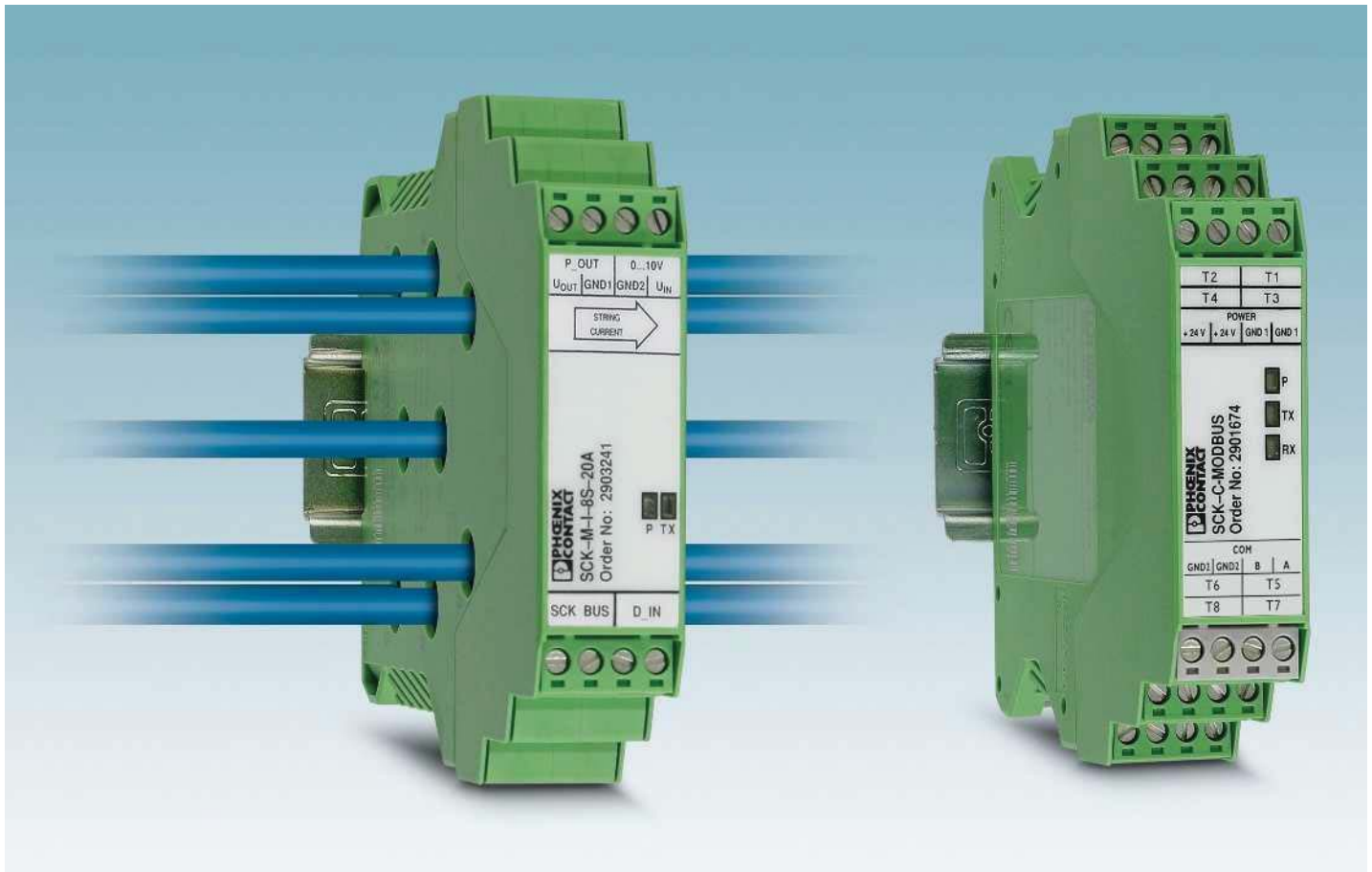

Utilize solar electricity efficiently

Detect errors – increase efficiency: photovoltaic systems should achieve maximum energy yield within the shortest possible time.

SOLARCHECK provides reliable information regarding the performance of your photovoltaic system. It can be used to detect faults, which may be caused by damaged panels, defective contacts or damage in the cabling. This allows you to implement countermeasures quickly, thereby increasing the efficiency of your system.

Current topic: reliable monitoring

Whether a small roof-top system on a family home or a megawatt outdoor system: for reliable operation, the photovoltaic market requires monitoring systems where status information is continuously available and visualization is easy. Phoenix Contact offers a comprehensive portfolio of hardware and software products specifically designed for this purpose.

Energy of the future

From installation to monitoring. The brochure “Solar power – Solutions for photovoltaics” includes additional innovative solutions for your photovoltaic system, such as:

- Connection technology
- Surge protection
- Hardware and software solutions
- Generator connection boxes
- Integral park management

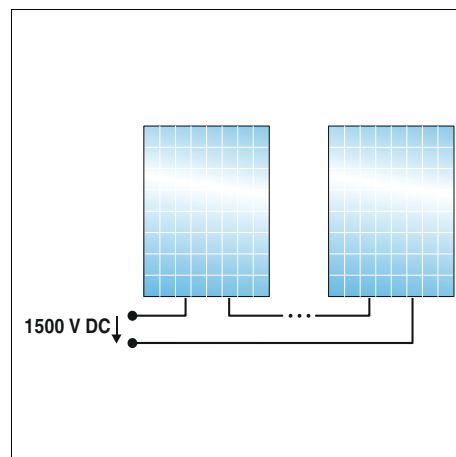

Contact-free current measurement

Contact-free measurement using Hall sensors offers many advantages:

- Safe isolation is already ensured by the cable insulation
- No contact resistance due to additional contact points
- Reliable current transfer, as there is no direct intervention in the string circuit

Space-saving installation without an additional power supply

With a width of just 22.5 mm, the narrow measuring module bundles the cables in a confined space.

- The 2-conductor communication cable is also used to supply the measuring modules
- This means that one communication module supplies up to eight measuring modules – without an additional power supply

Flexible expansion

Optional extension of voltage measurement up to 1,500 V DC

- Also suitable for grounded systems
- Suitable for PV systems with extra high system voltages
- Flexible use, even outside the SOLARCHECK system

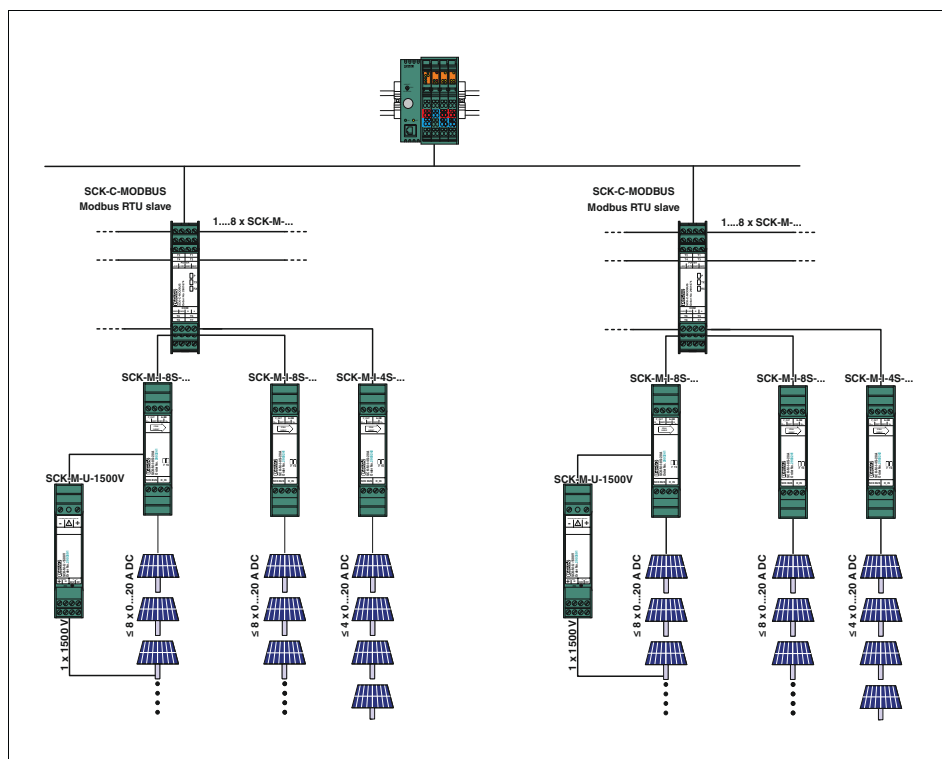

Easy integration in monitoring systems

The modular SOLARCHECK monitoring system consists of various measuring modules for current and voltage measurement and an associated communication module.

The communication module collects the measured values from the current measuring modules and forwards them to a higher-level controller. You can acquire up to eight or four string currents with one current measuring module each. A maximum of eight current measuring modules of any type can be connected to one communication module. The 2-conductor communication cable is also used to supply the measuring modules with power. This means that no additional power supply is required in the field.

The voltage measuring module is connected to and also supplied via the analog input provided on the 8-channel current measuring modules.

Monitoring

Monitoring and diagnostics

Solar system monitoring

PV string monitoring SOLARCHECK

The modular SOLARCHECK monitoring system consists of various devices for current and voltage measurement and an associated communication module.

Communication module:

- For connecting and collecting measured values from up to eight measuring modules
- Provision of data for transfer to higher-level controllers

Current measuring modules:

- 8-channel current measurement up to 20 A DC
- Detection of reverse currents up to -1 A
- 4-channel extension modules for 20 A DC
- Internal temperature monitoring
- Digital input for monitoring, e.g., the remote indication contacts of surge protection modules
- Supply via the communication module

Voltage measuring module

- Voltage measurement up to 1,500 V DC in any grounded PV system
- Connection and supply is usually via the analog input (0 to 10 V) provided on the 8-channel SOLARCHECK current measuring module
- Voltage measurement is output as an analog signal 2 to 10 V
- As an option, can also be removed from the SOLARCHECK group and used separately



Communication module
RS-485 (Modbus RTU)



Housing width 22.5 mm

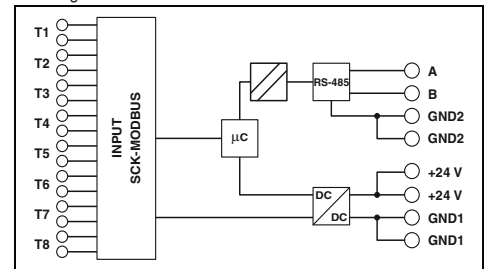

Technical data

Supply	
Supply voltage	24 V DC -10% ... +25%
Own current consumption	22 mA (typical)
Measuring input	
Current measuring range	-
Transmission error, maximum	-
Temperature coefficient	-
Reverse current detection	-
Number of measuring channels	-
Voltage measuring range	-
Connection method	-
Digital input	
Controlled by external floating contact	-
Analog input	
Input voltage range	-
Analog output	
Output voltage range	-
SCK-C-MODBUS data interface	
Cable length (for 0.15 mm ²)	-
Communication protocol	Proprietary
Serial port	RS-485
Serial transmission speed	9.6/14.4/19.2/38.4 kbps
Cable length	≤1200 m
Communication protocol	Modbus/RTU
General data	
Degree of protection	IP20
Ambient temperature range	-20°C ... 70°C
Dimensions W/H/D	22.5 / 102 / 106 mm
Screw connection rigid / flexible / AWG	0.2 ... 2.5 mm ² / 0.2 ... 2.5 mm ² / 24 - 12
EMC note	Class A product, see page 583
Conformance/approvals	
Conformance	CE-compliant
UL, USA	1741 Recognized
UL, USA/Canada	508 Listed

Ordering data

Description	Type	Order No.	Pcs./Pkt.
Communication module	SCK-C-MODBUS	2901674	1
Current measuring module, 8-channel			
Current measuring module, 4-channel for extension			
Voltage measuring module			



**Current measuring module,
20 A DC, 8-channel**

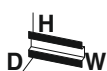

**Extension module, 4-channel
Current measurement 20 A DC**

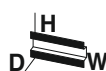

**Voltage measuring module,
0...1,500 V DC**



Housing width 22.5 mm

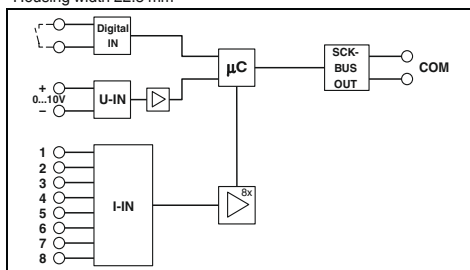

Technical data

Via SCK-C-MODBUS

43 mA (typical)

0 A DC ... 20 A (UL: 0 A DC...25 A DC)
± 1% (from the measuring range final value)

0.02%/K (T_{K20})
-1 A DC ... 0 mA
8

Through connection, 9.5 mm diameter

Floating switch contacts

0 V ... 10 V

≤300 m (0.14 mm²)
Proprietary

IP20
-20°C ... 70°C
22.5 / 102 / 128.5 mm
0.2 ... 2.5 mm² / 0.2 ... 2.5 mm² / 24 - 12
Class A product, see page 583

CE-compliant
1741 Recognized
508 Listed

Ordering data

Type	Order No.	Pcs./Pkt.
SCK-M-I-8S-20A	2903241	1



Housing width 22.5 mm

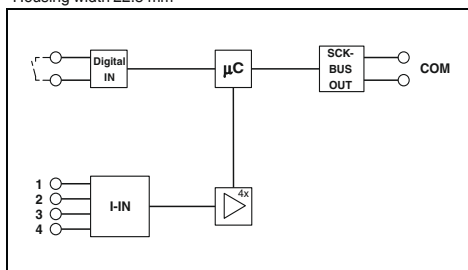

Technical data

Via SCK-C-MODBUS

43 mA (typical)

0 A DC ... 20 A (UL: 0 A DC...25 A DC)
± 1% (from the measuring range final value)

0.02%/K (T_{K20})
-1 A DC ... 0 mA
4

Through connection, 9.5 mm diameter

Floating switch contacts

-

≤300 m (0.14 mm²)
Proprietary

IP20
-20°C ... 70°C
22.5 / 102 / 128.5 mm
0.2 ... 2.5 mm² / 0.2 ... 2.5 mm² / 24 - 12
Class A product, see page 583

CE-compliant
1741 Recognized
508 Listed

Ordering data

Type	Order No.	Pcs./Pkt.
SCK-M-I-4S-20A	2903242	1



Housing width 22.5 mm

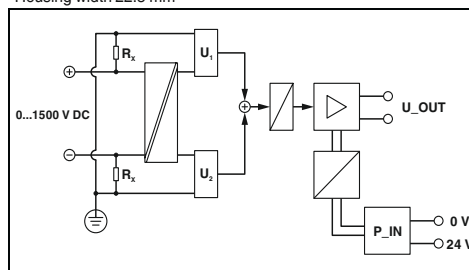

Technical data

24 V DC -10% ... +25% (or via SSCK-M-I-8S-20A)

8 mA (typical)

-
± 1% (after additional tuning (valid for 100 - 1,500 V DC))

<0.01%/K
-
1
0 V DC ... 1,500 V DC
Screw connection

-

-

2 V DC ... 10 V DC

-

-

-

-

IP20
-20°C ... 70°C
22.5 / 102 / 128.5 mm
0.2 ... 2.5 mm² / 0.2 ... 2.5 mm² / 24 - 12

CE-compliant
1741 Recognized
508 Listed

Ordering data

Type	Order No.	Pcs./Pkt.
SCK-M-U-1500V	2903591	1



For high system availability

EMD monitoring relays can be used to detect deviations in important system parameters at an early stage. These can be indicated or system parts can be shut down selectively. EMD monitoring relays ensure error-free and cost-effective operation of your system. They are an inexpensive solution for numerous monitoring functions.

- Surge voltage and undervoltage
- Overcurrent and undercurrent
- Phase failure, phase sequence, and phase asymmetry
- Power factor and active power
- Motor winding temperature
- Levels

For system monitoring, choose from two product ranges: compact or multifunctional monitoring relays.

Perfect timing

ETD timer relays ensure optimum time sequences.

The modules are the cost-effective alternative to a PLC: with easy configuration and fast wiring.

Choose from two product ranges for your ideal time control application:

- Ultra-narrow timer relays each with one time range and one function
- Multifunctional timer relays with selectable time ranges and functions

Professionally packaged components

Special function modules with professional housing and connection technology can be used to integrate electronic components in your system. They can be used to perform a variety of tasks:

- Diode modules provide protection against polarity reversal. In addition, they decouple messages in fault reporting systems
- Lamp testing modules decouple signals in isolation in the field of fault reporting technology
- Display modules simplify troubleshooting and provide help for monitoring processes



Compact monitoring relays

Ideal for simple monitoring tasks – from series production to building installation.

- Compact installation housing
- Quick and tool-free wiring with Push-in technology
- Parameters can be adjusted easily using rotary switches
- Clear diagnostics, thanks to color status LED



Multifunctional monitoring relays

- Parameters can be adjusted easily using rotary switches
- Fast error detection, thanks to fine tuning and short response times
- Worldwide use, thanks to wide-range power supply unit or plug-in transformer
- Space saving, with two PDT outputs in 22.5 mm wide housing
- Electrically isolated measuring and supply circuits
- Clear diagnostics, thanks to color status LEDs



Ultra-narrow timer relays

The space-saving and inexpensive solution for simple time control applications.

- Overall width of just 6.2 mm – saves up to 70% space compared to conventional timer relays
- Precise time setting using the illuminated thumbwheel
- Fast wiring through the use of plug-in bridges



Multifunctional timer relays

For universal use thanks to wide range of functions.

- Just three versions for all conventional time control applications
- Two floating PDT outputs on a design width of just 22.5 mm
- Supply voltage via wide-range power supply unit
- Optimum setting of times ranging from milliseconds to several days



Special function modules

Special function modules transform components such as diodes into a shock-proof and dust-proof electronics module.

- Easy installation, thanks to electronics housing with IP20 protection that can be installed in a control cabinet
- Fast mounting on DIN rails, thanks to the foot catch
- User-friendly wiring, thanks to practical connection technology

Monitoring

Monitoring and diagnostics

Monitoring relays

Single-phase current monitoring

The **EMD-BL-C-10** monitors AC currents from 0 to 10 A.

- Adjustable response delay
- 0 to 5 A or 0 to 10 A measuring range
- Adjustable via rotary switch on the front

Single-phase voltage monitoring

The **EMD-BL-V-230** monitors DC and AC voltages.

- 24 V AC/DC or 230 V AC
- Separately adjustable response delay
- Adjustable monitoring range
- Adjustable via potentiometer on front



Current monitoring, 1-phase
Overcurrent, undercurrent, window



Voltage monitoring, 1-phase
Undervoltage, window

ERIC
Housing width 17.5 mm

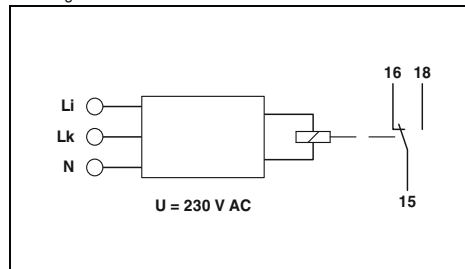

Technical data

Functions

Overcurrent, undercurrent, window

Input

Input ranges

Input ranges

0 A ... 5 A
0 A ... 10 A
Configurable via rotary switches

Input resistance

3 mΩ

Minimum setting range

5% ... 95% (from I_N)

Maximum setting range

10% ... 100% (from I_N)

Setting range for response delay

0.1 s ... 10 s

Basic accuracy

≤5% (of the nominal value)

Setting accuracy

± 5% (of the nominal value)

Repeat accuracy

≤2%

Relay output

Contact type

1 floating PDT

Switching capacity

1250 VA (5 A / 250 V AC)

Electrical service life

1x 10⁵ cycles

Mechanical service life

15x 10⁶ cycles

Output fuse

5 A (fast-blow)

General data

Supply voltage

230 V AC ±15%

Nominal power consumption

5 VA (0.8 W)

Degree of protection

IP40 (housing) / IP20 (connection terminal blocks)

Ambient temperature (operation)

-25°C ... 55°C

Dimensions W/H/D

17.5 / 88 / 65.5 mm

Push-in connection rigid / flexible / AWG

0.14 ... 2.5 mm² / 0.14 ... 2.5 mm² / 26 - 14

Screw connection rigid / flexible / AWG

0.5 ... 2.5 mm² / 0.5 ... 2.5 mm² / 20 - 14

Conformance/approvals

Conformance

CE-compliant

UL, USA/Canada

UL/C-UL listed UL 508

Description

Compact monitoring relays with Push-in connection

Compact monitoring relays with screw connection

Ordering data

Type	Order No.	Pcs./Pkt.
EMD-BL-C-10-PT	2903522	1
EMD-BL-C-10	2903521	1

ERIC
Housing width 17.5 mm

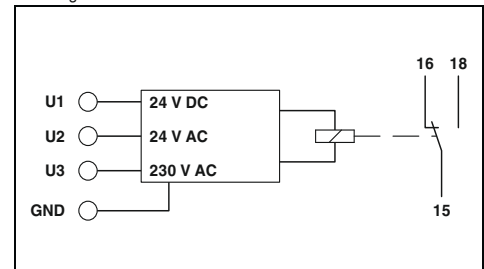

Technical data

Undervoltage, window

0 V DC ... 24 V DC (connection terminal blocks: U1 and GND)
0 V AC ... 24 V AC (connection terminal blocks: U2 and GND)
0 V AC ... 230 V AC (connection terminal blocks: U3 and GND)

75% ... 115% (from U_N)

80% ... 120% (from U_N)

0.1 s ... 10 s

≤5% (of scale end value)

± 5% (of scale end value)

≤2%

1 floating PDT

1250 VA (5 A / 250 V AC)

1x 10⁵ cycles

15x 10⁶ cycles

5 A (fast-blow)

-25% ... +20% (= measuring voltage)

10 VA (at 230 V AC (0.6 W))

1.3 VA (at 24 V AC (0.8 W))

0.6 W (at 24 V DC)

IP40 (housing) / IP20 (connection terminal blocks)

-25°C ... 55°C

17.5 / 88 / 65.5 mm

0.14 ... 2.5 mm² / 0.14 ... 2.5 mm² / 26 - 14

0.5 ... 2.5 mm² / 0.5 ... 2.5 mm² / 20 - 14

CE-compliant

UL/C-UL listed UL 508

Ordering data

Type	Order No.	Pcs./Pkt.
EMD-BL-V-230-PT	2903524	1
EMD-BL-V-230	2903523	1

Monitoring relays

Three-phase voltage monitoring

- The **EMD-BL-3V-400** monitors three-phase AC voltages.
- 3~ 400 V AC/230 V AC ±30%
 - Separately adjustable response delay
 - Adjustable monitoring range
 - Adjustable via potentiometer on front
 - Supply from the measuring circuit

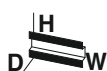

Voltage monitoring, 3-phase
Window, phase sequence

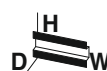

Phase monitoring
Phase sequence, phase failure, asymmetry

Phase monitoring

- The **EMD-BL-PH-400** monitors three-phase AC voltages.
- 3~ 208 to 480 V AC / 120 to 277 V AC
 - Adjustable response delay
 - Adjustable asymmetry: 5 to 25% / OFF
 - Adjustable via potentiometer on front
 - Supply from the measuring circuit

Housing width 17.5 mm

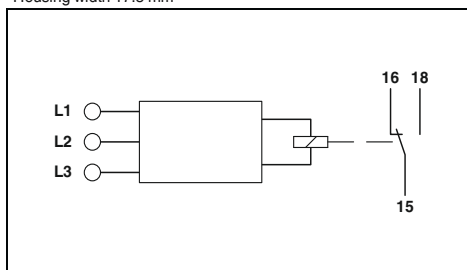

Housing width 17.5 mm

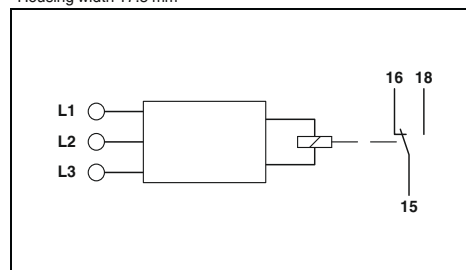

Technical data

Window, phase sequence

280 V AC ... 519 V AC
3~ 400/230 V
70% ... 120% (from U_N)
80% ... 130% (from U_N)
0.1 s ... 10 s
-
≤5% (of the nominal value)
± 5% (of scale end value)
≤2%

Ordering data

Type	Order No.	Pcs./Pkt.
EMD-BL-3V-400-PT	2903526	1
EMD-BL-3V-400	2903525	1

Technical data

Phase sequence, phase failure, asymmetry

187 V AC ... 519 V AC
3~ 208 ... 480 V/120 ... 277 V
-
-
0.1 s ... 10 s
5% ... 25% / OFF
≤5% (of scale end value)
± 5% (of scale end value)
≤2%

Ordering data

Type	Order No.	Pcs./Pkt.
EMD-BL-PH-480-PT	2903528	1
EMD-BL-PH-480	2903527	1

Functions	
Input	
Monitoring range	280 V AC ... 519 V AC
Input ranges	3~ 400/230 V
Minimum setting range	70% ... 120% (from U_N)
Maximum setting range	80% ... 130% (from U_N)
Setting range for response delay	0.1 s ... 10 s
Asymmetry	-
Basic accuracy	≤5% (of the nominal value)
Setting accuracy	± 5% (of scale end value)
Repeat accuracy	≤2%
Relay output	
Contact type	1 floating PDT
Switching capacity	1250 VA (5 A / 250 V AC)
Electrical service life	1x 10 ⁵ cycles
Mechanical service life	15x 10 ⁶ cycles
Output fuse	5 A (fast-blow)
General data	
Supply voltage	±30% (= measuring voltage)
Nominal power consumption	10 VA (1 W)
Degree of protection	IP40 (housing) / IP20 (connection terminal blocks)
Ambient temperature (operation)	-25°C ... 55°C
Dimensions W/H/D	17.5 / 88 / 65.5 mm
Push-in connection rigid / flexible / AWG	0.14 ... 2.5 mm ² / 0.14 ... 2.5 mm ² / 26 - 14
Screw connection rigid / flexible / AWG	0.5 ... 2.5 mm ² / 0.5 ... 2.5 mm ² / 20 - 14
Conformance/approvals	
Conformance	CE-compliant
UL, USA/Canada	UL/C-UL listed UL 508

Description	
Compact monitoring relays with Push-in connection	
Compact monitoring relays with screw connection	

Monitoring

Monitoring and diagnostics

Monitoring relays

Thermistor monitoring

The EMD-SL-PTC monitors the temperature of motor windings.

- Response value $\geq 3.6 \text{ k}\Omega$
- Release value $\leq 1.6 \text{ k}\Omega$
- DIN 44081- / DIN 44082-compliant
- Sensors can be connected in series



Temperature monitoring (motor windings)

ERC

Housing width 17.5 mm

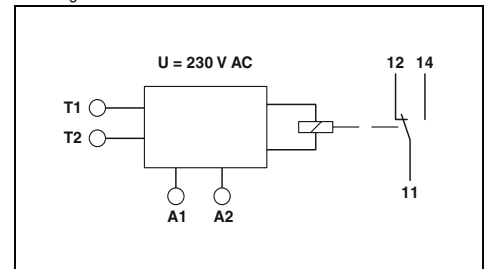

Technical data

Functions

Input

Total cold resistance
Response value
Release value
Basic accuracy

Relay output

Contact type
Switching capacity
Electrical service life
Mechanical service life
Output fuse

General data

Supply voltage
Nominal power consumption
Degree of protection
Ambient temperature (operation)
Dimensions W/H/D
Push-in connection rigid / flexible / AWG
Screw connection rigid / flexible / AWG

Conformance/approvals

Conformance

Winding temperature monitoring

$\leq 1.5 \text{ k}\Omega$
 $\geq 3.6 \text{ k}\Omega$ (relay drops out)
 $\leq 1.6 \text{ k}\Omega$ (relay picks up)
 $\pm 10\%$ (of scale end value)

1 floating PDT
1250 VA (5 A / 250 V AC)
 1×10^5 cycles
 15×10^6 cycles
5 A (fast-blow)

230 V AC (-15% ... +10%)
3.5 VA (0.5 W)
IP40 (housing) / IP20 (connection terminal blocks)
-25°C ... 55°C
17.5 / 88 / 65.5 mm
0.14 ... 2.5 mm² / 0.14 ... 2.5 mm² / 26 - 14
0.5 ... 2.5 mm² / 0.5 ... 2.5 mm² / 20 - 14

CE-compliant

Ordering data

Description

Compact monitoring relays
with Push-in connection
with screw connection

Type

EMD-BL-PTC-PT
EMD-BL-PTC

Order No.

2906253
2906252

Pcs./Pkt.

1
1



Monitoring

Monitoring and diagnostics

Monitoring relays

Single-phase current monitoring

EMD-...C... monitoring relays monitor DC and AC currents within the range of 0 to 10 A.

- Separately adjustable startup and release delays
- Variable supply voltage range
- Adjustable via potentiometer on front



Overcurrent and undercurrent monitoring



Over or undercurrent monitoring



Housing width 22.5 mm

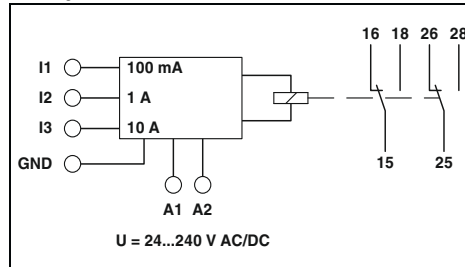

Technical data



Housing width 22.5 mm

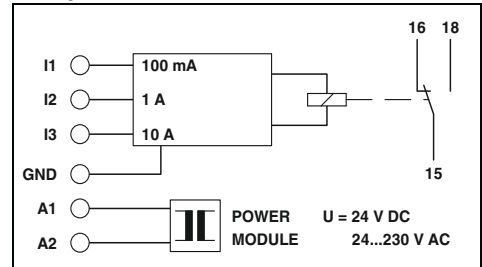

Technical data

Functions	Overcurrent, undercurrent, window, error memory
Input	
Input ranges	0 mA ... 100 mA (connection terminals: I1 and GND) 0 A ... 1 A (connection terminals: I2 and GND) 0 A ... 10 A (connection terminals: I3 and GND)
Input resistance	470 mΩ (at I _N = 100 mA) ; 47 mΩ (at I _N = 1 A) ; 5 mΩ (at I _N = 10 A)
Minimum setting range	5% ... 95% (from I _N)
Maximum setting range	10% ... 100% (from I _N)
Setting range for response delay	0.1 s ... 10 s
Setting range for starting delay	0 s ... 10 s
Basic accuracy	± 5% (of scale end value)
Setting accuracy	≤5% (of scale end value)
Repeat accuracy	≤2%
Relay output	
Contact type	2 floating PDT contacts
Switching capacity	750 VA (3 A/250 V AC, module aligned, ≤5 mm spacing) 1250 VA (5 A/250 V AC, module not aligned, ≥5 mm spacing)
Electrical service life	2x 10 ⁵ cycles at ohmic load, 1,000 VA
Mechanical service life	Approx. 2x 10 ⁷ cycles
Output fuse	5 A (fast-blow)
General data	
Supply voltage range	24 V AC ... 240 V AC -15% ... +10% 24 V DC ... 240 V DC -20% ... +25%
Nominal power consumption	4.5 VA (1.5 W)
Degree of protection	IP40 (housing) / IP20 (connection terminal blocks)
Ambient temperature (operation)	-25°C ... 55°C
Dimensions W/H/D	22.5 / 90 / 113 mm
Screw connection rigid / flexible / AWG	0.5 ... 2.5 mm ² / 0.25 ... 2.5 mm ² / 20 - 14
EMC note	Class A product, see page 583
Conformance/approvals	
Conformance	CE-compliant
UL, USA/Canada	UL/C-UL listed UL 508

EMD-SL-C-OC-10	EMD-SL-C-UC-10
Overcurrent	Undercurrent
Input ranges	0 mA ... 100 mA (connection terminals: I1 and GND) 0 A ... 1 A (connection terminals: I2 and GND) 0 A ... 10 A (connection terminals: I3 and GND)
Input resistance	470 mΩ (at I _N = 100 mA) ; 47 mΩ (at I _N = 1 A) ; 5 mΩ (at I _N = 10 A)
Minimum setting range	5% ... 95% (from I _N)
Maximum setting range	10% ... 100% (from I _N)
Setting range for response delay	0.2 s ... 10 s
Setting range for starting delay	-
Basic accuracy	± 5% (of scale end value)
Setting accuracy	≤5% (of scale end value)
Repeat accuracy	≤2%
Relay output	
Contact type	1 floating PDT
Switching capacity	750 VA (3 A/250 V AC, module aligned, ≤5 mm spacing) 1250 VA (5 A/250 V AC, module not aligned, ≥5 mm spacing)
Electrical service life	2x 10 ⁵ cycles at ohmic load, 1,000 VA
Mechanical service life	Approx. 2x 10 ⁷ cycles
Output fuse	5 A (fast-blow)
General data	
Supply voltage range	24 V AC ... 230 V AC (see Power modules) 24 V DC (see Power modules)
Nominal power consumption	2 VA (1.5 W)
Degree of protection	IP40 (housing) / IP20 (connection terminal blocks)
Ambient temperature (operation)	-25°C ... 55°C
Dimensions W/H/D	22.5 / 90 / 113 mm
Screw connection rigid / flexible / AWG	0.5 ... 2.5 mm ² / 0.25 ... 2.5 mm ² / 20 - 14
EMC note	
Conformance/approvals	
Conformance	CE-compliant
UL, USA/Canada	UL/C-UL listed UL 508

Ordering data

Description	Type	Order No.	Pcs./Pkt.
Electronic monitoring relay			
	EMD-FL-C-10	2866022	1
Power module			
Supply voltage 20 ... 30 V DC			
Supply voltage 20.2 ... 26.4 V AC			
Supply voltage 88 ... 121 V AC			
Supply voltage 108 ... 132 V AC			
Supply voltage 195 ... 264 V AC			

Ordering data

Description	Type	Order No.	Pcs./Pkt.
Electronic monitoring relay			
	EMD-SL-C-OC-10	2866019	1
	EMD-SL-C-UC-10	2867937	1
Power module			
Supply voltage 20 ... 30 V DC	EMD-SL-PS- 24DC	2885359	1
Supply voltage 20.2 ... 26.4 V AC	EMD-SL-PS- 24AC	2866103	1
Supply voltage 88 ... 121 V AC	EMD-SL-PS-110AC	2866116	1
Supply voltage 108 ... 132 V AC	EMD-SL-PS-120AC	2885731	1
Supply voltage 195 ... 264 V AC	EMD-SL-PS-230AC	2866129	1

Monitoring relays

Single-phase voltage monitoring

EMD-...V... monitoring relays monitor DC and AC voltages within the range 0 to 300 V.

- Separately adjustable startup and release delays
- Variable supply voltage range
- Adjustable via potentiometer on front

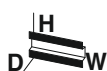

Undervoltage and overvoltage monitoring



Undervoltage monitoring

ERIE
Housing width 22.5 mm

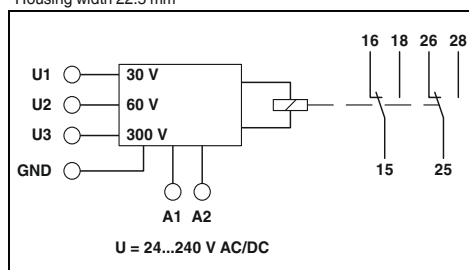

Technical data

Functions	Undervoltage, overvoltage, window, error memory
Input	
Input ranges	0 V ... 30 V AC/DC (connection terminal blocks: U1 and GND) 0 V ... 60 V AC/DC (connection terminal blocks: U2 and GND) 0 V ... 300 V AC/DC (connection terminal blocks: U3 and GND)
Input resistance	47 kΩ (connection terminal blocks: U1 and GND) 100 kΩ (connection terminal blocks: U2 and GND) 470 kΩ (connection terminal blocks: U3 and GND)
Minimum setting range	5% ... 95% (from U _N)
Maximum setting range	10% ... 100% (from U _N)
Setting range for response delay	0.1 s ... 10 s
Setting range for starting delay	0 s ... 10 s
Basic accuracy	± 5% (of scale end value)
Setting accuracy	≤5% (of scale end value)
Repeat accuracy	≤2%
Relay output	
Contact type	2 floating PDT contacts
Switching capacity	750 VA (3 A/250 V AC, module aligned, ≤5 mm spacing) 1250 VA (5 A/250 V AC, module not aligned, ≥5 mm spacing)
Electrical service life	2x 10 ⁵ cycles at ohmic load, 1,000 VA
Mechanical service life	Approx. 2x 10 ⁷ cycles
Output fuse	5 A (fast-blow)
General data	
Supply voltage range	24 V AC ... 240 V AC -15% ... +10% 24 V DC ... 240 V DC -20% ... +25% 4.5 VA (1.5 W)
Nominal power consumption	
Degree of protection	IP40 (housing) / IP20 (connection terminal blocks)
Ambient temperature (operation)	-25°C ... 55°C
Dimensions W/H/D	22.5 / 90 / 113 mm
Screw connection rigid / flexible / AWG	0.5 ... 2.5 mm ² / 0.25 ... 2.5 mm ² / 20 - 14
EMC note	Class A product, see page 583
Conformance/approvals	
Conformance	CE-compliant
UL, USA/Canada	UL/C-UL listed UL 508

ERIE
Housing width 22.5 mm

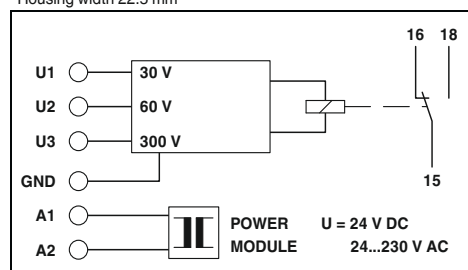

Technical data

Functions	Undervoltage
Input	
Input ranges	0 V ... 30 V AC/DC (connection terminal blocks: U1 and GND) 0 V ... 60 V AC/DC (connection terminal blocks: U2 and GND) 0 V ... 300 V AC/DC (connection terminal blocks: U3 and GND)
Input resistance	47 kΩ (connection terminal blocks: U1 and GND) 100 kΩ (connection terminal blocks: U2 and GND) 470 kΩ (connection terminal blocks: U3 and GND)
Minimum setting range	5% ... 95% (from U _N)
Maximum setting range	10% ... 100% (from U _N)
Setting range for response delay	0.2 s ... 10 s
Setting range for starting delay	-
Basic accuracy	± 5% (of scale end value)
Setting accuracy	≤5% (of scale end value)
Repeat accuracy	≤2%
Relay output	
Contact type	1 floating PDT
Switching capacity	750 VA (3 A/250 V AC, module aligned, ≤5 mm spacing) 1250 VA (5 A/250 V AC, module not aligned, ≥5 mm spacing)
Electrical service life	2x 10 ⁵ cycles at ohmic load, 1,000 VA
Mechanical service life	Approx. 2x 10 ⁷ cycles
Output fuse	5 A (fast-blow)
General data	
Supply voltage range	24 V AC ... 230 V AC (see Power modules) 24 V DC (see Power modules) 2 VA (1.5 W)
Nominal power consumption	
Degree of protection	IP40 (housing) / IP20 (connection terminal blocks)
Ambient temperature (operation)	-25°C ... 55°C
Dimensions W/H/D	22.5 / 90 / 113 mm
Screw connection rigid / flexible / AWG	0.5 ... 2.5 mm ² / 0.25 ... 2.5 mm ² / 20 - 14
EMC note	
Conformance/approvals	
Conformance	CE-compliant
UL, USA/Canada	UL/C-UL listed UL 508

Ordering data

Description	Type	Order No.	Pcs./Pkt.
Electronic monitoring relay			
EMD-FL-V-300		2866048	1
Power module			
Supply voltage 20 ... 30 V DC			
Supply voltage 20.2 ... 26.4 V AC			
Supply voltage 88 ... 121 V AC			
Supply voltage 108 ... 132 V AC			
Supply voltage 195 ... 264 V AC			

Ordering data

Description	Type	Order No.	Pcs./Pkt.
EMD-SL-V-UV-300		2866035	1
EMD-SL-PS-24DC		2885359	1
EMD-SL-PS-24AC		2866103	1
EMD-SL-PS-110AC		2866116	1
EMD-SL-PS-120AC		2885731	1
EMD-SL-PS-230AC		2866129	1

Monitoring

Monitoring and diagnostics

Monitoring relays

Three-phase voltage monitoring

EMD-...-3V... monitoring relays monitor three-phase AC voltages of 160 to 897 V AC (depending on the device concerned).

- Adjustable response delay
- Variable supply voltage range thanks to pluggable power module (order separately)
- Adjustable via potentiometer on front
- Adjustable asymmetry

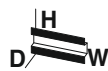

Undervoltage and phase monitoring,
400 V or 230 V



Undervoltage and phase monitoring,
500 V or 690 V

Housing width 22.5 mm

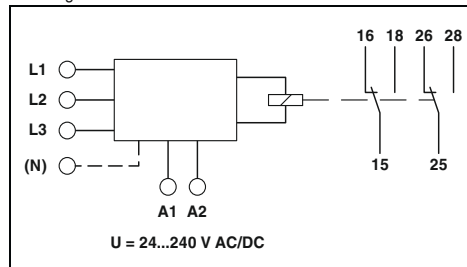

Housing width 45 mm

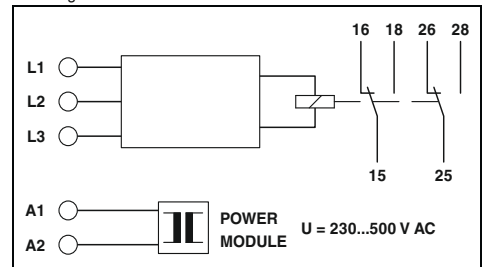

Functions

Input

Monitoring range
Input ranges
Input resistance
Minimum setting range
Maximum setting range
Setting range for response delay
Asymmetry
Basic accuracy
Setting accuracy
Repeat accuracy

Relay output

Contact type
Switching capacity

Electrical service life
Mechanical service life
Output fuse

General data

Supply voltage
Supply voltage range

Nominal power consumption
Degree of protection
Ambient temperature (operation)
Dimensions W/H/D
Screw connection rigid / flexible / AWG
EMC note
Conformance/approvals
Conformance
UL, USA/Canada

Technical data

	EMD-FL-3V-400	EMD-FL-3V-230
Functions	Undervoltage, window, asymmetry, phase sequence, phase failure	Undervoltage, window, asymmetry, phase sequence, phase failure
Input	280 V AC ... 520 V AC 3 N ~ 400/230 V 1 MΩ	161 V AC ... 299 V AC 3 N ~ 230/132 V 470 kΩ
Relay output	2 floating PDT contacts 750 VA (3 A/250 V AC, module aligned, ≤5 mm spacing) 1250 VA (5 A/250 V AC, module not aligned, ≥5 mm spacing)	2 floating PDT contacts 750 VA (3 A/250 V AC, module aligned, ≤5 mm spacing) 1250 VA (5 A/250 V AC, module not aligned, ≥5 mm spacing)
General data	230 V AC 24 V AC ... 240 V AC -15% ... +10% 24 V DC ... 240 V DC -20% ... +25% 4.5 VA (1.5 W) IP40 (housing) / IP20 (connection terminal blocks) -25°C ... 55°C 22.5 / 90 / 113 mm 0.5 ... 2.5 mm ² / 0.25 ... 2.5 mm ² / 20 - 14 Class A product, see page 583	161 V AC ... 299 V AC 3 N ~ 230/132 V 470 kΩ 2x 10 ⁵ cycles at ohmic load, 1,000 VA Approx. 2x 10 ⁷ cycles 5 A (fast-blow)
Ordering data	CE-compliant UL/C-UL listed UL 508	CE-compliant UL/C-UL listed UL 508

Description

Electronic monitoring relay

Power module

Supply voltage 20 ... 30 V DC
Supply voltage 20.2 ... 26.4 V AC
Supply voltage 88 ... 121 V AC
Supply voltage 108 ... 132 V AC
Supply voltage 195 ... 264 V AC
Supply voltage 323 ... 456 V AC
Supply voltage 425 ... 550 V AC

Technical data

	EMD-FL-3V-690	EMD-FL-3V-500
Functions	Undervoltage, window, asymmetry, phase sequence, phase failure	Undervoltage, window, asymmetry, phase sequence, phase failure
Input	483 V AC ... 897 V AC 3 ~ 690 V 1 MΩ	350 V AC ... 650 V AC 3 ~ 500 V 1 MΩ
Relay output	2 floating PDT contacts 750 VA (3 A/250 V AC, module aligned, ≤5 mm spacing) 1250 VA (5 A/250 V AC, module not aligned, ≥5 mm spacing)	2 floating PDT contacts 750 VA (3 A/250 V AC, module aligned, ≤5 mm spacing) 1250 VA (5 A/250 V AC, module not aligned, ≥5 mm spacing)
General data	230 V AC ... 500 V AC (see Power modules) 4.5 VA (1.5 W) IP40 (housing) / IP20 (connection terminal blocks) -25°C ... 55°C 45 / 90 / 113 mm 0.5 ... 2.5 mm ² / 0.25 ... 2.5 mm ² / 20 - 14	2x 10 ⁵ cycles at ohmic load, 1,000 VA Approx. 2x 10 ⁷ cycles 5 A (fast-blow)
Ordering data	CE-compliant UL/C-UL listed UL 508	CE-compliant UL/C-UL listed UL 508

Description

Electronic monitoring relay

Type	Order No.	Pcs./Pkt.
EMD-FL-3V-400	2866064	1
EMD-FL-3V-230	2865773	1
EMD-FL-3V-690	2885249	1
EMD-FL-3V-500	2867979	1
EMD-SL-PS45-230AC	2885294	1
EMD-SL-PS45-400AC	2885304	1
EMD-SL-PS45-500AC	2885317	1



**Undervoltage/overvoltage monitoring,
400 V with/without neutral conductor**



**Phase monitoring,
400 V**



**Phase monitoring,
690 V**

ERIE
Housing width 22.5 mm

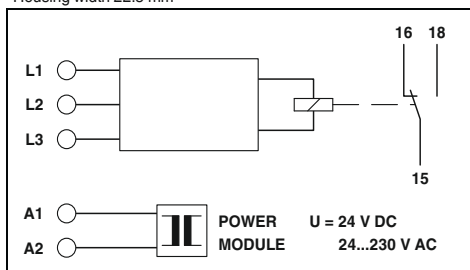

Technical data

EMD-SL-3V-400	EMD-SL-3V-400-N
Window, without neutral conductor connection	Window, with neutral conductor connection

280 V AC ... 520 V AC 3 ~ 400 V 1 MΩ -30% ... 20% (from U _N) -20% ... 30% (from U _N) 0.2 s ... 10 s	280 V AC ... 520 V AC 3 N ~ 400/230 V 1 MΩ
--	--

± 5% (of scale end value)
≤ 5% (of scale end value)
≤ 2%

1 floating PDT 750 VA (3 A/250 V AC, module aligned, ≤ 5 mm spacing) 1250 VA (5 A/250 V AC, module not aligned, ≥ 5 mm spacing)

2x 10 ⁵ cycles at ohmic load, 1,000 VA Approx. 2x 10 ⁷ cycles 5 A (fast-blow)

24 V AC ... 230 V AC (see Power modules)
24 V DC (see Power modules)
2 VA (1.5 W)
IP40 (housing) / IP20 (connection terminal blocks)
-25°C ... 55°C
22.5 / 90 / 113 mm
0.5 ... 2.5 mm ² / 0.25 ... 2.5 mm ² / 20 - 14

CE-compliant
UL/C-UL listed UL 508

Ordering data

Type	Order No.	Pcs./Pkt.
EMD-SL-3V-400	2866051	1
EMD-SL-3V-400-N	2885278	1
EMD-SL-PS- 24DC	2885359	1
EMD-SL-PS- 24AC	2866103	1
EMD-SL-PS-110AC	2866116	1
EMD-SL-PS-120AC	2885731	1
EMD-SL-PS-230AC	2866129	1

ERIE
Housing width 22.5 mm

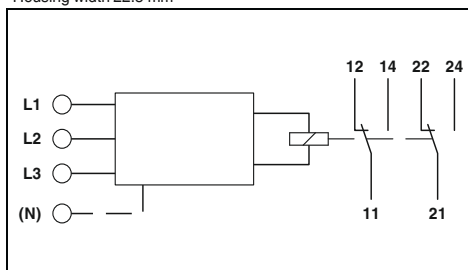

Technical data

Phase sequence, phase failure, asymmetry

342 V AC ... 457 V AC 3 N ~ 400/230 V 15 kΩ

≤ 350 ms (fixed setting)
Fixed, approx. 30%

2 floating PDT contacts 750 VA (3 A/250 V AC, module aligned, ≤ 5 mm spacing) 1250 VA (5 A/250 V AC, module not aligned, ≥ 5 mm spacing)
--

2x 10 ⁵ cycles at ohmic load, 1,000 VA Approx. 2x 10 ⁷ cycles 5 A (fast-blow)

From the measured voltage

9 VA IP40 (housing) / IP20 (connection terminal blocks)
-25°C ... 55°C
22.5 / 90 / 113 mm
0.5 ... 2.5 mm ² / 0.25 ... 2.5 mm ² / 20 - 14

CE-compliant
UL/C-UL listed UL 508

Ordering data

Type	Order No.	Pcs./Pkt.
EMD-SL-PH-400	2866077	1

ERIE
Housing width 22.5 mm

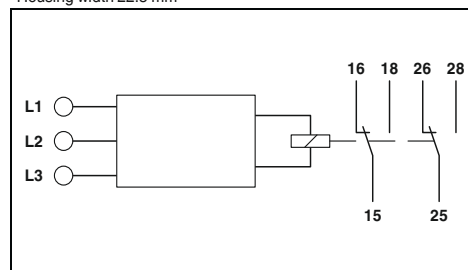

Technical data

Undervoltage, phase sequence, phase failure

177 V AC ... 794 V AC 3 ~ 208 V ... 690 V
--

0.1 s ... 10 s
25%

≤ 3% (of scale end value)
≤ 5% (of scale end value)
≤ 2%

2 floating PDT contacts 1250 VA (5 A/250 V AC at +55°C) 150 VA (5 A/30 V DC at +55°C)

2x 10 ⁵ cycles 20x 10 ⁶ cycles 5 A (fast-blow)
--

± 15% (= measuring voltage)
± 15% (= measuring voltage)

2 VA (1.2 W) IP40 (housing) / IP20 (connection terminal blocks)
-25°C ... 70°C (C300)
22.5 / 90 / 113 mm
0.5 ... 2.5 mm ² / 0.5 ... 2.5 mm ² / 20 - 14

CE-compliant
UL/C-UL listed UL 508

Ordering data

Type	Order No.	Pcs./Pkt.
EMD-SL-PH-690	2905597	1

Monitoring

Monitoring and diagnostics

Monitoring relays

Effective power monitoring

The active power in single and 3-phase networks is monitored with the **EMD-FL-RP-480** active power monitoring relay.

- Monitoring range up to 7.2 kW
- Separately adjustable startup and release delays
- Temperature monitoring of the motor winding
- Variable supply voltage range
- Detection of switched off loads

Load monitoring (cos φ)

The **EMD-FL-PF-400** monitoring relay is a cos φ monitor for load monitoring in single or three-phase networks.



Effective power monitoring



Load monitoring (cos φ)

ERIC

Housing width 45 mm

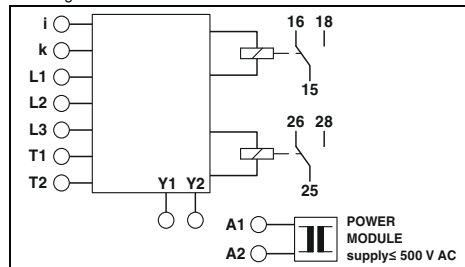

Technical data

Functions

Underload, overload, window, winding temperature monitoring

Input

Description of the input

Measured value

Measuring ranges P_N

Voltage input

AC sine (10 Hz ... 400 Hz)

Can be switched between 0.75 kW, 1.5 kW, 3 kW and 6 kW

Nominal input voltage U_N

Input ranges

480 V (3 N ~ 480/277 V)

0 V AC ... 480 V AC (1(N) ~, single-phase load)

0 V AC ... 480 V AC (3(N) ~, 3-phase load)

Input ranges

0.15 A ... 6 A (range: 0.75 kW and 1.5 kW)

0.3 A ... 12 A (range: 3 kW and 6 kW)

Minimum setting range

Maximum setting range

Switching threshold cos φ

5% ... 110% (of P_N)

10% ... 120% (of P_N)

Min.

Max.

Relay output

Contact type

Switching capacity

2 floating PDT contacts

750 VA (3 A/250 V AC, module aligned, ≤5 mm spacing)

1250 VA (5 A/250 V AC, module not aligned, ≥5 mm spacing)

Electrical service life

2x 10⁵ cycles at ohmic load, 1,000 VA

Mechanical service life

Output fuse

General data

Supply voltage range

Approx. 2x 10⁷ cycles

5 A (fast-blow)

110 V AC ... 500 V AC (see Power modules)

Nominal power consumption

Rated insulation voltage

Degree of protection

Ambient temperature (operation)

Dimensions W/H/D

Screw connection rigid / flexible / AWG

EMC note

Conformance/approvals

Conformance

UL, USA/Canada

3.5 VA (3 W)

300 V (in accordance with EN 50178)

IP40 (housing) / IP20 (connection terminal blocks)

-25°C ... 55°C

45 / 90 / 113 mm

0.5 ... 2.5 mm² / 0.25 ... 2.5 mm² / 20 - 14

CE-compliant

UL applied for

Description

Electronic monitoring relay

Power module, plug-in, please order at the same time!

Supply voltage 195 ... 264 V AC

Supply voltage 323 ... 456 V AC

Supply voltage 425 ... 550 V AC

Ordering data

Type	Order No.	Pcs./Pkt.
EMD-FL-RP-480	2900177	1
EMD-SL-PS45-230AC	2885294	1
EMD-SL-PS45-400AC	2885304	1
EMD-SL-PS45-500AC	2885317	1

ERIC

Housing width 22.5 mm

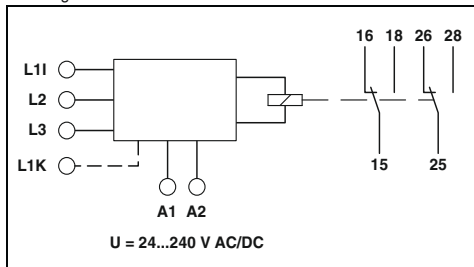

Technical data

Underload, overload, Window

-

AC sine (10 ... 100 Hz)

-

3 N ~ 415/240 V

40 V AC ... 415 V AC (1(N) ~, single-phase load)

40 V AC ... 415 V AC (3(N) ~, 3-phase load)

0.5 A ... 10 A (connection terminal blocks: L1i and L1k)

-

-

0.1 ... 0.99

0.2 ... 1

2 floating PDT contacts

750 VA (3 A/250 V AC, module aligned, ≤5 mm spacing)

1250 VA (5 A/250 V AC, module not aligned, ≥5 mm spacing)

2x 10⁵ cycles at ohmic load, 1,000 VA

Approx. 2x 10⁷ cycles

5 A (fast-blow)

24 V AC ... 240 V AC -15% ... +10%

24 V DC ... 240 V DC (-20% ... +25%)

4.5 VA (1.5 W)

300 V (in accordance with EN 50178)

IP40 (housing) / IP20 (connection terminal blocks)

-25°C ... 55°C

22.5 / 90 / 113 mm

0.5 ... 2.5 mm² / 0.25 ... 2.5 mm² / 20 - 14

Class A product, see page 583

CE-compliant

UL/C-UL listed UL 508

Ordering data

Type	Order No.	Pcs./Pkt.
EMD-FL-PF-400	2885809	1

Filling level monitoring

The **EMD-SL-LL-...** monitoring relay monitors the level of electrically conductive liquids with the help of conductive probes (not supplied as standard).

- Adjustable response delay
- Adjustable via potentiometer on front

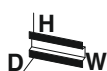

Temperature monitoring (motor windings)



Filling level monitoring

Housing width 22.5 mm

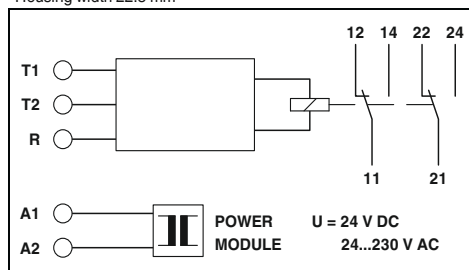

Technical data

Housing width 22.5 mm

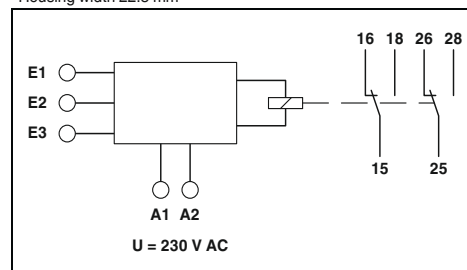

Technical data

Functions

Input

Total cold resistance
Response value
Release value
Basic accuracy
Repeat accuracy
Measuring input
Maximum probe voltage
Maximum probe current
Length of probe cable

Switching Threshold

Relay output

Contact type
Switching capacity

Electrical service life

Mechanical service life

Output fuse

General data

Supply voltage
Supply voltage range

Nominal power consumption

Degree of protection

Ambient temperature (operation)

Dimensions W/H/D

Screw connection rigid / flexible / AWG

EMC note

Conformance/approvals

Conformance
UL, USA/Canada

Winding temperature monitoring

<1.5 kΩ
≥3.6 kΩ (relay drops out)
≤1.8 kΩ (relay picks up)
± 10% (of scale end value)
≤2%
-
-
-

2 floating PDT contacts
750 VA (3 A/250 V AC, module aligned, ≤5 mm spacing)
1250 VA (5 A/250 V AC, module not aligned, ≥5 mm spacing)

2x 10⁵ cycles at ohmic load, 1,000 VA

Approx. 2x 10⁷ cycles

5 A (fast-blow)

24 V AC ... 230 V AC (see Power modules)
24 V DC (see Power modules)
2 VA (1.5 W)
IP40 (housing) / IP20 (connection terminal blocks)
-25°C ... 55°C
22.5 / 90 / 113 mm
0.5 ... 2.5 mm² / 0.25 ... 2.5 mm² / 20 - 14
Class A product, see page 583

CE-compliant
UL/C-UL listed UL 508

Pumping up (minimum monitoring),
pumping down (maximum monitoring)

-
-
-
-
-
Conductive probe, type: SK1, SK2, SK3
16 V AC
7 mA
<1,000 m (line capacity 100 nF/km; set value <50%)
<100 m (line capacity 100 nF/km; set value 100%)

0.25 kΩ ... 100 kΩ (4 mS ... 1 μS)

2 floating PDT contacts
750 VA (3 A/250 V AC, module aligned, ≤5 mm spacing)
1250 VA (5 A/250 V AC, module not aligned, ≥5 mm spacing)

2x 10⁵ cycles at ohmic load, 1,000 VA

Approx. 2x 10⁷ cycles

5 A (fast-blow)

EMD-SL-LL-230 EMD-SL-LL-110
230 V AC -15% ... +15% AC 110 V AC -10% ... +15% AC

2 VA (1.5 W)
IP40 (housing) / IP20 (connection terminal blocks)
-25°C ... 55°C
22.5 / 90 / 113 mm
0.5 ... 2.5 mm² / 0.25 ... 2.5 mm² / 20 - 14

CE-compliant
UL/C-UL listed UL 508

Ordering data

Description

Electronic monitoring relay

Power module

Supply voltage 20 ... 30 V DC
Supply voltage 20.2 ... 26.4 V AC
Supply voltage 88 ... 121 V AC
Supply voltage 108 ... 132 V AC
Supply voltage 195 ... 264 V AC

Type	Order No.	Pcs./Pkt.
EMD-SL-PTC	2866093	1
EMD-SL-PS- 24DC	2885359	1
EMD-SL-PS- 24AC	2866103	1
EMD-SL-PS-110AC	2866116	1
EMD-SL-PS-120AC	2885731	1
EMD-SL-PS-230AC	2866129	1

Ordering data

Type

Order No.

Pcs./Pkt.

EMD-SL-LL-230	2885906	1
EMD-SL-LL-110	2901137	1

Compact timer relays

The multifunctional timer relay offers universal use thanks to a variety of functions and various time settings. The rotary switches on the front of the housing allow easy configuration. The compact design also allows flexible use.

Main features:

- Adjustable time
- Time range: 50 ms to 1 h
- Non-floating control input
- Delay functions
- Wiper functions
- Output: one electrically isolated PDT
- Clear diagnostics via status LED



Multifunctional timer relay

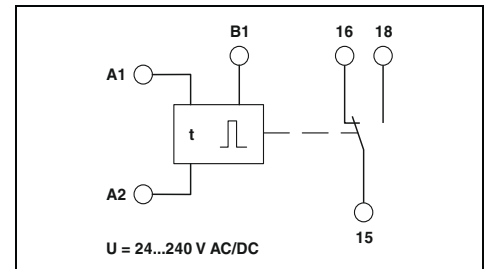

Technical data

E: with switch-on delay
 Rs: with release delay and control contact
 Es: with switch-on delay and control contact
 Ws: with single shot leading edge and control contact

Functions

Control contact	
Connection	Non-floating, terminals A1-B1
Control pulse length	≥50 ms (DC)
Relay output	
Contact type	1 floating PDT
Switching capacity	1250 VA (5 A / 250 V AC)
Mechanical service life	15x 10 ⁶ cycles
General data	
Supply voltage	24 V DC ... 240 V DC -20% ... +25%
Degree of protection	IP40 (housing) / IP20 (connection terminal blocks)
Ambient temperature range	-25°C ... 55°C
Dimensions W/H/D	17.5 / 88 / 65.5 mm
Push-in connection rigid / flexible / AWG	0.14 ... 2.5 mm ² / 0.14 ... 2.5 mm ² / 26 - 14
Screw connection rigid / flexible / AWG	0.5 ... 2.5 mm ² / 0.5 ... 2.5 mm ² / 20 - 14
Conformance/approvals	
Conformance	CE-compliant
UL, USA/Canada	UL 508 Listed

Ordering data

Description	
Compact timer relay , multifunctional, with screw connection	
Compact timer relay , multifunctional, with Push-in connection	

Type	Order No.	Pcs./Pkt.
ETD-BL-1T-230	2905813	1
ETD-BL-1T-230-PT	2905814	1

Compact timer relays

As an impulse encoder with adjustable times, the ETD-BL-2T-I-230 offers a range of flashing functions. The rotary switches on the front of the housing allow easy configuration. The compact design also allows flexible use.

Main features:

- Two adjustable times
- Time ranges: 50 ms to 100 h
- Flashing function
- Wide-range power supply unit
- Output: two floating changeover contacts
- Clear diagnostics via status LED

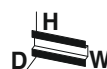

Impulse encoder,
adjustable pulse and pause times

ERC

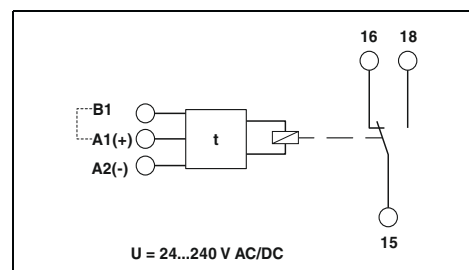

Technical data

Functions	
Time ranges	50 ms ... 100 h (7 time end ranges)
Setting range	
Control contact	
Connection	Non-floating, terminals A1-B1
Control pulse length	≥50 ms (DC)
Relay output	
Contact type	1 floating PDT
Switching capacity	750 VA (3 A/250 V AC, module aligned, ≤5 mm spacing) 1250 VA (5 A/250 V AC, module not aligned, ≥5 mm spacing)
Mechanical service life	Approx. 2×10^7 cycles
General data	
Supply voltage	24 V AC/DC ... 240 V AC/DC -10% ... +15%
Nominal power consumption	2.5 VA (1 W)
Degree of protection	IP40 (housing) / IP20 (connection terminal blocks)
Ambient temperature range	-25°C ... 55°C
Dimensions W/H/D	17.5 / 88 / 65.5 mm
Push-in connection rigid / flexible / AWG	0.14 ... 2.5 mm ² / 0.14 ... 2.5 mm ² / 26 - 14
Screw connection rigid / flexible / AWG	0.5 ... 2.5 mm ² / 0.5 ... 2.5 mm ² / 20 - 14
Conformance/approvals	
Conformance	CE-compliant

lp: switched-mode beginning with the pause
li: switched-mode beginning with the pulse

Ordering data

Description	Type	Order No.	Pcs./Pkt.
Compact timer relay, impulse encoder			
- with Push-in connection	ETD-BL-2T-I-230-PT	2907714	1
- with screw connection	ETD-BL-2T-I-230	2907713	1

Monitoring

Monitoring and diagnostics

Plug-in timer modules for RIF-1, RIF-2, RIF-3, and RIF-4

The multifunctional plug-in timer module transforms a relay module into a timer relay. RIF-1 to RIF-4 bases can be equipped with this module. Using DIP switches, three time functions and four time ranges can be selected. Detailed time settings are made using a potentiometer. Relays can be operated with an input voltage of 12, or 24 V AC/DC.



Timer module for RIF-1 to RIF-4 relay modules for 12 to 24 V AC/DC input voltage



- The time functions:
- With switch-on delay
 - With passing make contact
 - Pulse generator

- Time ranges:
- 0.5 to 10 s
 - 5 to 100 s
 - 0.5 to 10 min
 - 5 to 100 min

With switch-on delay

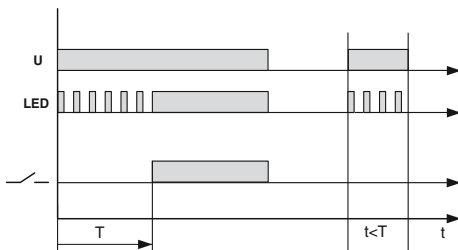

Passing make contact

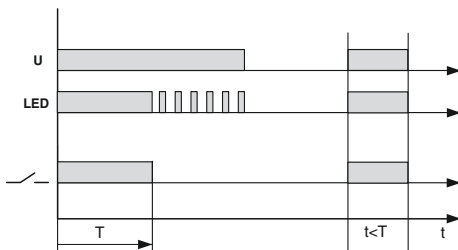

Pulse generator

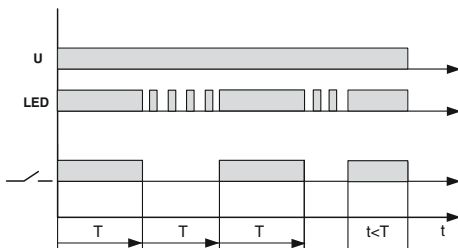

Input data
Nominal input voltage U_N
Nominal input voltage range with reference to U_N
Input circuit
Output data
Limiting continuous current
General data
Mounting position
Repeat accuracy
Ambient temperature (operation)
Standards/specifications

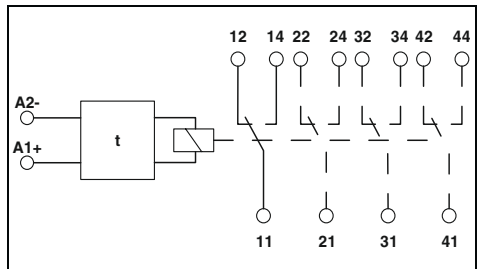

Technical data

24 V DC (AC operation only permitted for RIF-1)
0.4 ... 1.2
Varistor, yellow LED

≤250 mA (relay coil current)

any
1%
-25°C ... 50°C (RIF-1, AC coil, 2 PDTs at 6 A)
-25°C ... 50°C (RIF-1, DC coil, 2 PDTs at 5 A)
-25°C ... 40°C (RIF-2, DC coil, 2 PDTs at 8 A)
-25°C ... 40°C (RIF-2, DC coil, 4 PDTs at 5 A)
-25°C ... 40°C (RIF-3, DC coil, 3 PDTs at 6.75 A)
-25°C ... 40°C (RIF-3, DC coil, 2 PDTs at 8 A)
-25°C ... 35°C (RIF-4, DC coil, 3 PDTs at 8 A)
-25°C ... 25°C (RIF-4, DC coil, 3 N/O contacts at 8 A)
DIN EN 50178

Ordering data

Type	Order No.	Pcs./Pkt.
RIF-T3-24UC	2902647	1

Description
Timer module , for mounting on RIF-1 to RIF-4, with LED status indicator for extending a relay module to create a timer relay with an input voltage of 24 V AC/DC



Ultra-narrow timer relays

The **ETD-BL-1T...** ultra-narrow timer relays show their strengths in applications that involve set parameters for functionality and time range.

- Application-oriented device selection: One function, one time range
- High level of setting accuracy, thanks to labeled and illuminated thumb wheel
- 6.2 mm slim design width

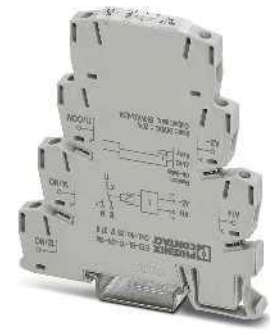

Timer relay with switch-on delay, voltage controlled

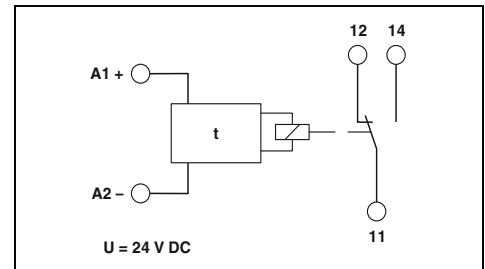

Technical data

Functions

ON: with switch-on delay

Control contact

Connection

Control pulse length

Relay output

Contact type

Switching capacity

Mechanical service life

General data

Supply voltage

Typical nominal current

Impulse withstand voltage

Degree of protection

Ambient temperature range

Dimensions W/H/D

Screw connection rigid / flexible / AWG

Push-in connection rigid / flexible / AWG

Conformance/approvals

Conformance

ATEX

UL, USA/Canada

-

min. 50 ms

1 floating PDT

1,500 VA (6 A / 250 V AC)

Approx. 2x 10⁷ cycles

24 V DC (19.2 V DC ...30 V DC)

15 mA (relay ON)

7 mA (relay OFF)

6 kV (in accordance with EN 50178)

IP20

-20°C ... 65°C

6.2 / 80 / 86 mm

0.14 ... 2.5 mm² / 0.14 ... 2.5 mm² / 30 - 12

0.14 ... 2.5 mm² / 0.14 ... 2.5 mm² / 26 - 14

CE-compliant

Ex II 3 G Ex nA nC IIC T4 Gc X

UL/C-UL listed UL 508

Ordering data

Type	Order No.	Pcs./Pkt.
ETD-BL-1T-ON- 10S	2917379	1
ETD-BL-1T-ON-300S	2917382	1
ETD-BL-1T-ON- 30MIN	2917395	1
ETD-BL-1T-ON-300MIN	2917405	1
ETD-BL-1T-ON- 10S-PT	2901476	1
ETD-BL-1T-ON-300S-PT	2901477	1
ETD-BL-1T-ON- 30MIN-PT	2901478	1
ETD-BL-1T-ON-300MIN-PT	2901479	1

Description

Compact timer relay, with screw connection

Time range 0.1...10 s

Time range 3...300 s

Time range 0.3...30 min

Time range 3...300 min

Compact timer relay, with Push-in connection

Time range 0.1...10 s

Time range 3...300 s

Time range 0.3...30 min

Time range 3...300 min

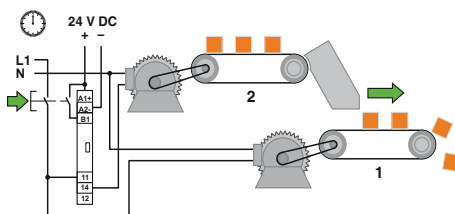

Conveyor belt 1 starts immediately

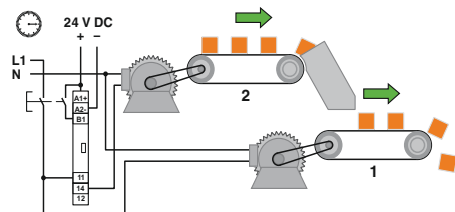

Conveyor belt 2 starts with a time delay



Timer relay with switch-on delay, with control contact



Timer relay with off delay, with control contact



Timer relay with flashing indic. function, beginning with the pulse

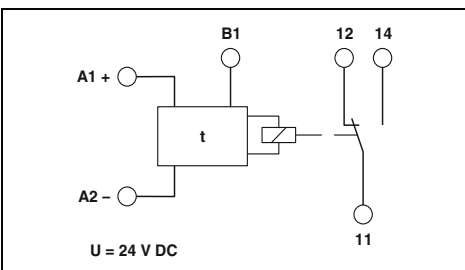

Technical data

ON-CC: with switch-on delay with control contact

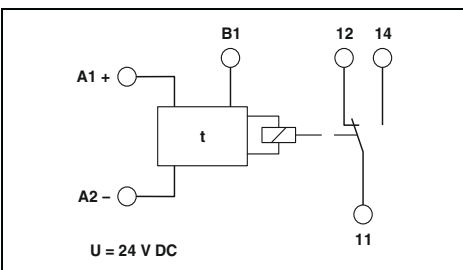

Technical data

OFF-CC: off delay with control contact

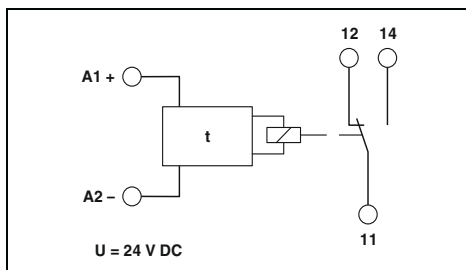

Technical data

F: flashing beginning with pulse

Non-floating, terminals A1-B1
min. 50 ms

1 floating PDT
1,500 VA (6 A / 250 V AC)
Approx. 2x 10⁷ cycles

24 V DC (19.2 V DC ... 30 V DC)
15 mA (relay ON)
7 mA (relay OFF)
6 kV (in accordance with EN 50178)
IP20
-20°C ... 65°C
6.2 / 80 / 86 mm
0.14 ... 2.5 mm² / 0.14 ... 2.5 mm² / 30 - 12
0.14 ... 2.5 mm² / 0.14 ... 2.5 mm² / 26 - 14

CE-compliant
Ex II 3 G Ex nA nC IIC T4 Gc X
UL/C-UL listed UL 508

Non-floating, terminals A1-B1
min. 50 ms

1 floating PDT
1,500 VA (6 A / 250 V AC)
Approx. 2x 10⁷ cycles

24 V DC (19.2 V DC ... 30 V DC)
15 mA (relay ON)
7 mA (relay OFF)
6 kV (in accordance with EN 50178)
IP20
-20°C ... 65°C
6.2 / 80 / 86 mm
0.14 ... 2.5 mm² / 0.14 ... 2.5 mm² / 30 - 12
0.14 ... 2.5 mm² / 0.14 ... 2.5 mm² / 26 - 14

CE-compliant
Ex II 3 G Ex nA nC IIC T4 Gc X
UL/C-UL listed UL 508

-
min. 50 ms

1 floating PDT
1,500 VA (6 A / 250 V AC)
Approx. 2x 10⁷ cycles

24 V DC (19.2 V DC ... 30 V DC)
15 mA (relay ON)
7 mA (relay OFF)
6 kV (in accordance with EN 50178)
IP20
-20°C ... 65°C
6.2 / 80 / 86 mm
0.14 ... 2.5 mm² / 0.14 ... 2.5 mm² / 30 - 12
0.14 ... 2.5 mm² / 0.14 ... 2.5 mm² / 26 - 14

CE-compliant
Ex II 3 G Ex nA nC IIC T4 Gc X
UL/C-UL listed UL 508

Ordering data

Type	Order No.	Pcs./Pkt.
ETD-BL-1T-ON-CC- 10S	2917418	1
ETD-BL-1T-ON-CC-300S	2917421	1
ETD-BL-1T-ON-CC- 30MIN	2917434	1
ETD-BL-1T-ON-CC-300MIN	2917447	1
ETD-BL-1T-ON-CC- 10S-PT	2901480	1
ETD-BL-1T-ON-CC-300S-PT	2901481	1
ETD-BL-1T-ON-CC- 30MIN-PT	2901483	1
ETD-BL-1T-ON-CC-300MIN-PT	2901484	1

Ordering data

Type	Order No.	Pcs./Pkt.
ETD-BL-1T-OFF-CC- 10S	2917450	1
ETD-BL-1T-OFF-CC-300S	2917463	1
ETD-BL-1T-OFF-CC- 30MIN	2917467	1
ETD-BL-1T-OFF-CC-300MIN	2917489	1
ETD-BL-1T-OFF-CC- 10S-PT	2901485	1
ETD-BL-1T-OFF-CC-300S-PT	2901486	1
ETD-BL-1T-OFF-CC- 30MIN-PT	2901487	1
ETD-BL-1T-OFF-CC-300MIN-PT	2901488	1

Ordering data

Type	Order No.	Pcs./Pkt.
ETD-BL-1T-F- 10S	2917492	1
ETD-BL-1T-F-300S	2917502	1
ETD-BL-1T-F- 30MIN	2917515	1
ETD-BL-1T-F-300MIN	2917528	1
ETD-BL-1T-F- 10S-PT	2901489	1
ETD-BL-1T-F-300S-PT	2901490	1
ETD-BL-1T-F- 30MIN-PT	2901491	1
ETD-BL-1T-F-300MIN-PT	2901492	1

Ultra-narrow multifunctional timer relays

Ultra-narrow multifunctional TR-PLC timer relays are the most cost-effective and space-saving solution for simple time control applications.

- Four time range settings
- Four function selections
- Select devices with ease: Choose the function and time range you want using DIP switches
- Illuminated thumbwheel for accurate time settings
- Space-saving: overall width of just 6.2 mm

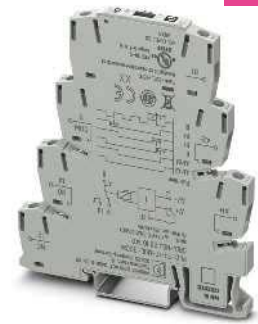

new

Multifunctional timer relay

Housing width 6.2 mm

Functions	
Time ranges	
Setting range	
Control contact	
Connection	
Control pulse length	
Relay output	
Contact type	
Switching capacity	
Mechanical service life	
General data	
Supply voltage	
Nominal power consumption	
Degree of protection	
Ambient temperature range	
Housing material	
Dimensions W/H/D	
Screw connection rigid / flexible / AWG	
Conformance/approvals	
Conformance	
UL, USA/Canada	

Technical data	
E: with switch-on delay	
Es: with switch-on delay and control contact	
Rs: with release delay and control contact	
Bi: flashing beginning with pulse	
0.1 s ... 300 min. (4 time end ranges)	
Non-floating, terminals A1-B1	
≥50 ms	
1 floating PDT	
1,500 VA (6 A / 250 V AC)	
Approx. 2x 10 ⁷ cycles	
24 V DC (19.2 V DC ... 30 V DC)	
0.45 W (at 24 V DC)	
IP20	
-20°C ... 65°C	
Polyamide PA, self-extinguishing	
6.2 / 80 / 86 mm	
0.14 ... 2.5 mm ² / 0.14 ... 2.5 mm ² / 30 - 12	
CE-compliant	
UL/C-UL listed UL 508	

Description	
Multifunctional timer relays with adjustable functions and time, with screw connection	
Multifunctional timer relays with adjustable functions and time, with Push-in connection	

Ordering data		
Type	Order No.	Pcs./Pkt.
PLC-TR-1T-MUL-300M	2910140	1
PLC-TR-1T-MUL-300M-PT	2910141	1

The desired function and time range can be set using the DIP switches on the side of the device:

DIP switch		Function	DIP switch		Time range
S3	S4		S2	S1	
OFF	OFF	E	OFF	OFF	0.1 ... 10 s
OFF	ON	Es	OFF	ON	3 ... 300 s
ON	OFF	Rs	ON	OFF	0.3 ... 30 min
ON	ON	Bi	ON	ON	3 ... 300 min



Multifunctional timer relays

The full range of conventional applications can be accommodated by the three versions of the **ETD** multifunctional timer relay.

- Suitable for universal use thanks to varied functions and selectable time ranges
- Time ranges from a few milliseconds to several days
- Variable supply voltage range
- 2 floating PDT outputs



**Multifunctional timer relay,
two adjustable times**



Housing width 22.5 mm

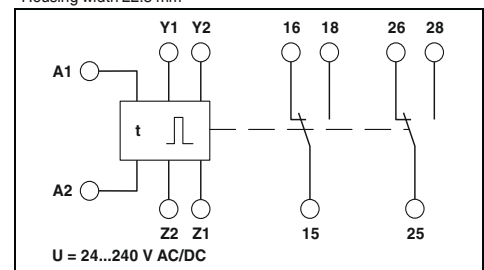

Technical data

Functions

lp: switched-mode beginning with the pause
 li: switched-mode beginning with the pulse
 ER: with switch-on and release delay with control contact
 EWu: with switch-on delay and single shot leading edge, voltage controlled
 EWs: with switch-on delay and single shot leading edge with control contact
 WsWa: with single shot leading edge and single shot trailing edge with control contact
 Wt: pulse sequence evaluation (retriggerable release delay)

Time ranges

Setting range
 Control contact
 Connection

50 ms ... 10 h (10 time end ranges)

Load capacity

Cable length
 Control pulse length
 Relay output
 Contact type
 Switching capacity

Floating, basic isolation between connection and input/output/bridge Y1-Y2
 Cannot carry load

<10 m
 min. 50 ms (only with Wt function: >7 ms)

Mechanical service life

General data
 Supply voltage

Approx. 2×10^7 cycles

Nominal power consumption
 Degree of protection

24 V DC ... 240 V DC -20% ... +25%
 24 V AC ... 240 V AC -15% ... +10%
 2.5 VA (1 W)
 IP40 (housing) / IP20 (connection terminal blocks)

Ambient temperature range

Housing material
 Dimensions W/H/D
 Screw connection rigid / flexible / AWG
 EMC note

-25°C ... 55°C
 Polyamide PA, self-extinguishing
 22.5 / 90 / 113 mm
 0.5 ... 2.5 mm² / 0.5 ... 2.5 mm² / 20 - 14
 Class A product, see page 583

Conformance/approvals

Conformance
 UL, USA/Canada

CE-compliant
 UL/C-UL listed UL 508

Ordering data

Description

Electronic timer relay with adjustable functions and times

Type

ETD-FL-2T-DTI

Order No.

2866187

Pcs./Pkt.

1

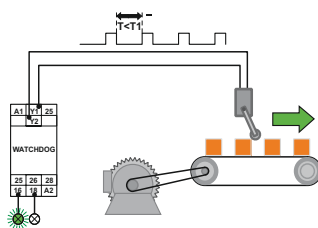

Function: pulse sequence evaluation

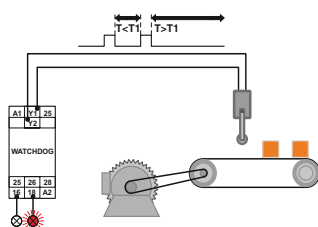

Message for incorrect pulse

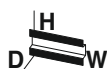

**Multifunctional timer relay,
one adjustable time**



**Impulse encoder,
adjustable pulse and pause times**

Housing width 22.5 mm

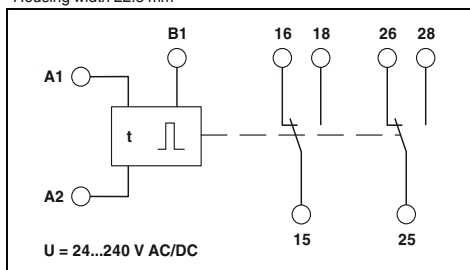

Technical data

- E: with switch-on delay
- Rs: with release delay and control contact
- Es: with switch-on delay and control contact
- Wu: with single shot leading edge, voltage controlled
- Ws: with single shot leading edge and control contact
- Wa: with single shot trailing edge and control contact
- Bi: flashing beginning with pulse
- Bp: flashing beginning with pause

50 ms ... 100 h (7 time end ranges)

Non-floating, terminals A1-B1

Parallel switched minimum load current 1 VA (0.5 W), terminals A2-B1

<10 m
min. 70 ms

2 floating PDT contacts
750 VA (3 A/250 V AC, module aligned, ≤5 mm spacing)
1250 VA (5 A/250 V AC, module not aligned, ≥5 mm spacing)

Approx. 2x 10⁷ cycles

24 V DC ... 240 V DC -20% ... +25%
24 V AC ... 240 V AC -15% ... +10%
2.5 VA (1 W)
IP40 (housing) / IP20 (connection terminal blocks)

-25°C ... 55°C
Polyamide PA, self-extinguishing
22.5 / 90 / 113 mm
0.5 ... 2.5 mm² / 0.5 ... 2.5 mm² / 20 - 14
Class A product, see page 583

CE-compliant
UL/C-UL listed UL 508

Ordering data

Type	Order No.	Pcs./Pkt.
ETD-SL-1T-DTF	2866161	1

Housing width 22.5 mm

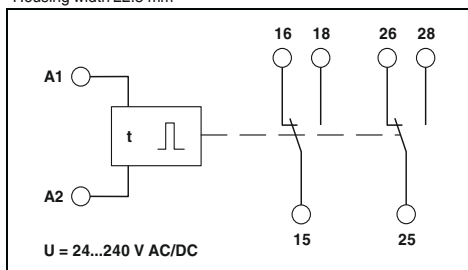

Technical data

- Ip: switched-mode beginning with the pause
- Ii: switched-mode beginning with the pulse

50 ms ... 100 h (7 time end ranges)

-

-

-

2 floating PDT contacts
750 VA (3 A/250 V AC, module aligned, ≤5 mm spacing)
1250 VA (5 A/250 V AC, module not aligned, ≥5 mm spacing)

Approx. 2x 10⁷ cycles

24 V DC ... 240 V DC -20% ... +25%
24 V AC ... 240 V AC -15% ... +10%
2.5 VA (1 W)
IP40 (housing) / IP20 (connection terminal blocks)

-25°C ... 55°C
Polyamide PA, self-extinguishing
22.5 / 90 / 113 mm
0.5 ... 2.5 mm² / 0.5 ... 2.5 mm² / 20 - 14
Class A product, see page 583

CE-compliant
UL/C-UL listed UL 508

Ordering data

Type	Order No.	Pcs./Pkt.
ETD-SL-2T-I	2866174	1

Diode modules

Diode circuits perform various tasks in electrical control systems, particularly in electronic ones:

- Electrical decoupling of messages in fault signaling systems
- Spark-suppression diodes for limiting surge voltages of inductive loads, (solenoid valves, DC relays or similar)
- Can be supplied as “diode gates” combined with anode or cathode or as freely assignable diodes

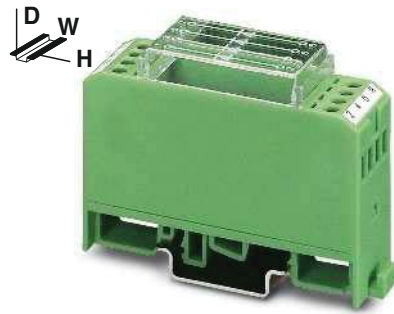

With diode type 1 N 4007

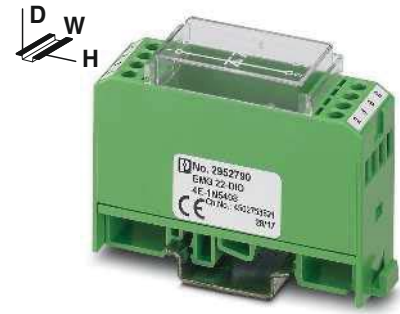

With diode type 1 N 5408

Notes:
Further circuit diagrams can be found in the data sheet at phoenixcontact.net/products.

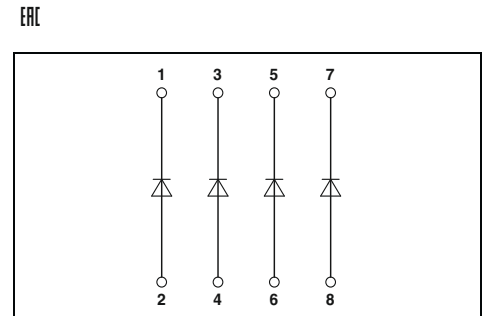
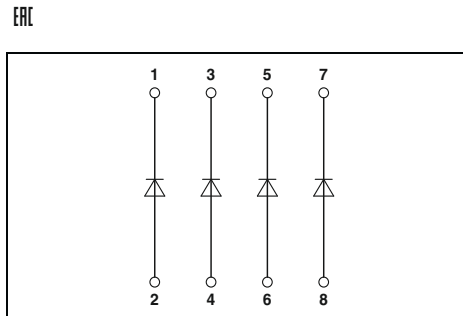

	Technical data		Technical data	
Diodes	4E / 8E / 17E / 7P / 7M	14P / 14M / 32P / 32M	4E-... / 4P-... / 4M-... / 8E-...	8P-... / 8M-...
Max. operating voltage U_{max}	1300 V	1300 V	1,000 V	1,000 V
Peak reverse voltage per diode	5 μ A	5 μ A	10 μ A	10 μ A
Reverse current per diode	Approx. 0.8 V	Approx. 0.8 V	Approx. 0.8 V	Approx. 0.8 V
Conducting state voltage per diode				
Conducting state current per diode	with single load: 0.7 A	0.7 A	1.5 A	1.5 A
	with simultaneous loads: 0.5 A	0.2 A	1 A	0.3 A
General data				
Ambient temperature range	-20°C ... 50°C		-20°C ... 50°C	
Degree of pollution	2 (in accordance with EN 50178)		2 (in accordance with EN 50178)	
Mounting position	Any		Any	
Mounting	In rows with zero spacing		In rows with zero spacing	
Dimensions H / D	75 / 55 mm		75 / 55 mm	
Screw connection rigid / flexible / AWG	0.2 ... 4 mm ² / 0.2 ... 2.5 mm ² / 24 - 12		0.2 ... 4 mm ² / 0.2 ... 2.5 mm ² / 24 - 12	
Conformance/approvals	CE-compliant		CE-compliant	
Conformance				

		Ordering data			Ordering data		
Description	Housing width	Type	Order No.	Pcs./Pkt.	Type	Order No.	Pcs./Pkt.
Diode module, can be individually wired	4 diodes 22.5 mm	EMG 22-DIO 4E	2950048	10	EMG 22-DIO 4E-1N5408	2952790	10
	8 diodes 45 mm	EMG 45-DIO 8E	2950103	5	EMG 45-DIO 8E-1N5408	2949389	5
	17 diodes 90 mm	EMG 90-DIO 17E	2954895	5			
Diode module, with P polarity (common cathode)	4 diodes 22.5 mm	EMG 22-DIO 7P	2950064	10	EMG 22-DIO 4P-1N5408	2952198	10
	7 diodes 22.5 mm				EMG 45-DIO 8P-1N5408	2954879	5
	8 diodes 45 mm						
	14 diodes 45 mm						
	32 diodes 90 mm						
Diode module, with M polarity (common anode)	4 diodes 22.5 mm	EMG 22-DIO 7M	2950077	10	EMG 22-DIO 4M-1N5408	2952211	10
	7 diodes 22.5 mm				EMG 45-DIO 8M-1N5408	2954882	5
	8 diodes 45 mm						
	14 diodes 45 mm						
	32 diodes 90 mm				EMG 45-DIO 14M	2950129	5
		EMG 90-DIO 32M	2954934	5			

		Accessories		Accessories	
Equipment marker	EMG-GKS 12	2947035	50	EMG-GKS 12	2947035 50

Lamp testing modules

Lamp testing modules for checking lamps that are installed and ready for operation:

- Individual checking of separate lamps (EMG...-E/LP)
- Centrally controlled checking of lamps (EMG...-M/LP)

Display modules

- Light indicator modules facilitate the monitoring of processes on electronic control systems during troubleshooting

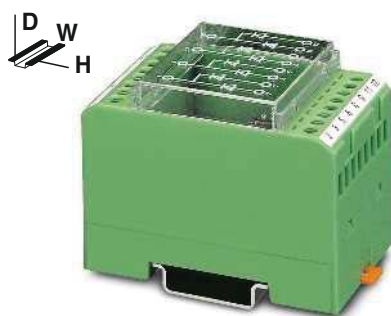

Lamp testing module, groups of 2 diodes with common cathode

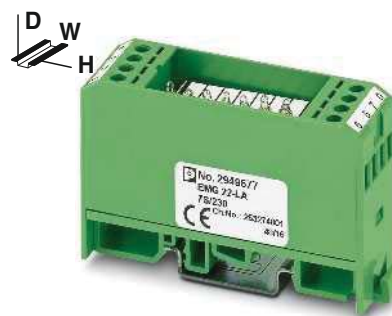

Light indicator module, with common return line

Notes:
Further circuit diagrams can be found in the data sheet at phoenixcontact.net/products.

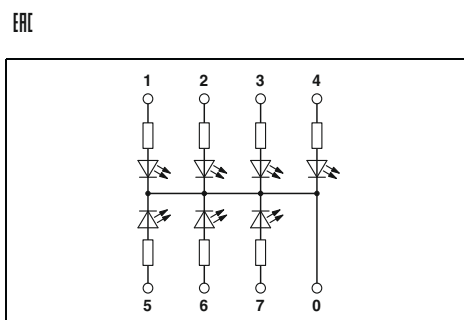
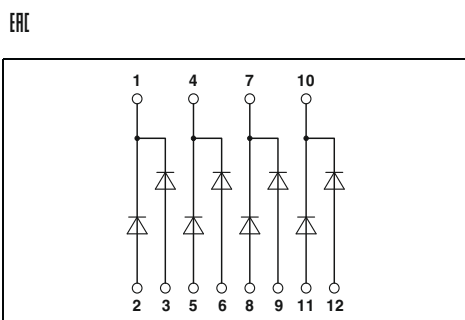

Technical data	
Diodes	8E/16E
Max. operating voltage U_{max}	1300 V
Peak reverse voltage per diode	$\leq 5 \mu A$
Reverse current per diode	Approx. 0.8 V
Conducting state voltage per diode	with single load 0.7 A
Conducting state current per diode	with simultaneous loads 0.4 A
Input	
Current required per light indicator	Approx. 1 mA
General data	
Ambient temperature range	-20°C ... 50°C
Degree of pollution	2 (in accordance with EN 50178)
Mounting position	Any
Mounting	In rows with zero spacing
Dimensions H / D	75 / 55 mm
Screw connection rigid / flexible / AWG	0.2 ... 4 mm ² / 0.2 ... 2.5 mm ² / 24 - 12
Conformance/approvals	CE-compliant
Conformance	

Technical data	
Diodes	14M/32M
Max. operating voltage U_{max}	1300 V
Peak reverse voltage per diode	$\leq 5 \mu A$
Reverse current per diode	Approx. 0.8 V
Conducting state voltage per diode	with single load 0.7 A
Conducting state current per diode	with simultaneous loads 0.2 A
Input	
Current required per light indicator	Approx. 3 mA
General data	
Ambient temperature range	-20°C ... 45°C
Degree of pollution	2 (in accordance with EN 50178)
Mounting position	Any
Mounting	In rows with zero spacing
Dimensions H / D	75 / 47.5 mm
Screw connection rigid / flexible / AWG	0.2 ... 4 mm ² / 0.2 ... 2.5 mm ² / 24 - 12
Conformance/approvals	CE-compliant
Conformance	

Ordering data	
Description	Housing width
Lamp testing module, for individual wiring	
4-pair	45 mm
8-pair	90 mm
Lamp testing module, with common control	
7-pair	45 mm
16-pair	90 mm
Light indicator module, 110 ... 230 V AC input voltage	
7 LEDs and shared return line	22.5 mm
Light indicator module, 24 V DC input voltage	
7 red LEDs and shared return line	22.5 mm
14 red LEDs and shared return line	45 mm

Type	Order No.	Pcs./Pkt.
EMG 45-DIO 8E/LP	2954798	5
EMG 90-DIO 16E/LP	2954808	5
EMG 45-DIO14M/LP	2950132	5
EMG 90-DIO 32M/LP	2954785	5

Type	Order No.	Pcs./Pkt.
EMG 22-LA 7S/230	2949677	10
EMG 22-LED 7S/24	2952305	10
EMG 45-LED 14S/24	2952334	5

Accessories	
Equipment marker	EMG-GKS 12

Accessories	
EMG-GKS 12	2947035

Accessories	
EMG-GKS 12	2947035



Relay modules

The importance of the reliability of industrial automation equipment is growing with the increase in use of electronic modules.

Modern relays or solid-state relay interfaces perform a wide range of tasks. No matter what the field – production technology, electrical equipment for machines, control engineering for power distribution, building automation, or process engineering – the aim is to ensure signal exchange between process peripherals and the higher-level central control systems. And this exchange must be reliable, floating, and electrically unambiguous. Safe electrical interface modules that meet the requirements of modern system concepts must include the following features:

- Coupling of different signal levels
- Safe electrical isolation between input and output
- High interference insensitivity

In practice, a relay interface comes into use when a flexible interface configuration with a large switching capacity range and the possibility of combining different types of contact is required. Further important features of relay interfaces are:

- Electrical isolation between open contacts
- Switching of independent switching current types
- High short-term overload resistance in the event of a short circuit or voltage peaks
- Practically impervious to electromagnetic fields
- Simple handling

Solid-state relay modules are used when an interface between the process peripherals and electronics is subject to the following requirements:

- Low control power
- High switching frequencies
- Wear-resistant and bounce-free switching
- Insensitive to vibrations and shocks
- Long service life

Product range overview

Product overview	270
Basics of relay technology	272
Basics of solid-state relay technology	276
Sensor/actuator configuration aids and handling of interference signals	278
RIFLINE complete – Industrial relay system	280
PLC-INTERFACE – Highly-compact relay modules	360
PLC logic – Programmable logic relay system	428
Relay modules in terminal block design – DEK series	438
Special relays and solid-state relay modules	444

Relay modules

Product overview

RIFLINE complete



RIF-0 for relays and solid-state relays
Page 282



RIF-1 for relays and solid-state relays
Page 288



RIF-1 relay module with force-guided contacts
Page 338



RIF-2 for industrial relays
Page 298

PLC-INTERFACE



With relay/solid-state relay
Page 364
As sensor/actuator version
Page 374



For high inrush/continuous currents
Page 382
Resistant to interference currents/voltages
Page 388



For Ex areas (zone 2)
Page 386



With switch
Page 406
For railway applications
Page 417

DEK series



With miniature relays
Page 439



Actuator series with miniature relays
Page 441

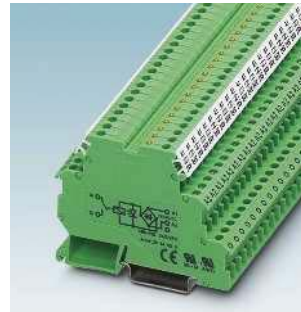

Sensor series with miniature relays
Page 441



With solid-state relays
Page 442

Safety devices



Safety devices
See Catalog 6



Monitoring relays
Page 246



Timer relays
Page 260



RIF-2 for Ex areas
Page 344



RIF-3 for octal relays
Page 304



RIF-4 for high-power relays
Page 310



Accessories
Page 316

PLC logic



For NAMUR initiators
Types of electronics
Page 422
Page 423



With lockable manual operation
Page 368



With force-guided contacts
Page 370



PLC logic – Programmable logic relay system
Page 428

Special relays and solid-state relay modules

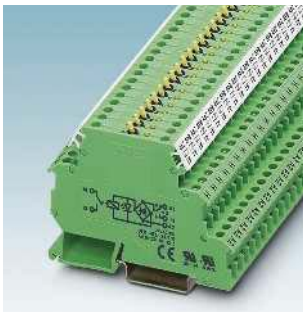

Relay terminal blocks with switch
Page 445



Interference-free relays and solid-state relays
Page 446



Relays for switching lamp loads
Page 449



Solid-state power relays with 400 V AC/3 A output
Page 450

Basics of relay technology

General information

Electromechanical relays are used as interface modules between the process I/O devices, on the one hand, and the open-loop/closed-loop control and signaling equipment, on the other, for level and power adjustment purposes.

Essentially, electromechanical relays can be divided into two main groups: mono-stable and bi-stable relays.

With monostable DC or AC relays, the contacts automatically return to the release state as soon as they are de-energized.

In the case of bi-stable relays, the contacts remain in their present switch position when the excitation current is switched off.

The documented relay data is based on test conditions and design criteria in accordance with IEC 61810. Data may vary or be limited when mounting relays on DIN rail bases or on PCBs. Numerous parameters, such as:

- Operating time
- Load current
- Input voltage
- Dense mounting arrangement
- Heat dissipation into the environment and the layout for PCB applications ultimately determine the data for the overall arrangement

The Phoenix Contact supply range features numerous ready-mounted relay combinations and base combinations, including some with additional input plug-in modules. These are tested under worst case conditions. The documented data then applies to the combinations.

Coil side

Input circuits and voltage types

There are various kinds of input circuits depending on the type of relay used and the nature of the control voltage.

If pure AC relays are used (AC input), the input circuit is generally nothing more than a visual switching status indicator.

Unless otherwise specified, the frequency of the control voltage is 50/60 Hz.

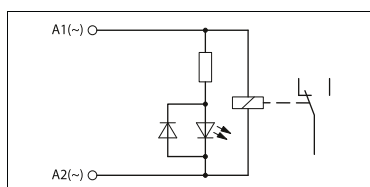

Basic structure of a relay with AC input

In the case of a pure DC input, the most important addition to the circuit is a freewheeling diode. This limits the voltages induced on the coil on circuit interruption to a value of approximately 0.7 V, which does not pose a danger to any connected control electronics.

As the freewheeling diode can only perform its required function if the polarity of the voltage connection is correct, a polarity protection diode is also integrated into the input circuit.

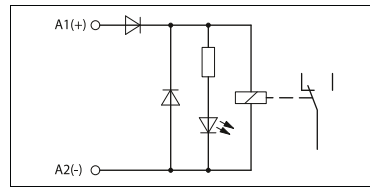

Basic structure of a relay with DC input

To allow DC or AC voltage operation, a bridge rectifier is connected in the input circuit. The diodes are simultaneously responsible for performing rectification, freewheeling, and polarity reversal protection functions. The interrupting voltage of the coil is limited to approximately 1.4 V

To protect the input circuit against overvoltages, a varistor is also connected (depending on the type) upstream of the bridge rectifier.

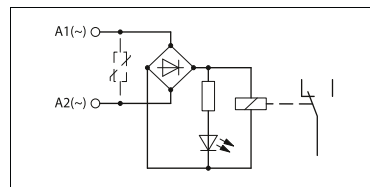

Basic structure of a relay with AC/DC input

Bi-stable latching relays with a double winding are only ever operated with DC voltage.

With these types of relays, there are three coil connections on the coil side. In addition to the common connection, there are separate connections for “setting” and “resetting”; these are controlled by short pulses only. As a result, the relays hardly heat up at all. Simultaneous control of both control inputs is not permitted.

A distinction is made between negative switching (M) and positive switching (P) types, depending on the polarity of the freewheeling and polarity protection diodes.

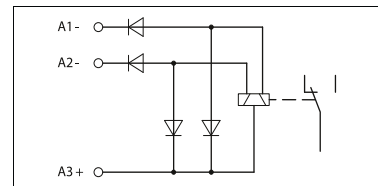

Basic structure of a bi-stable relay, negative switching type

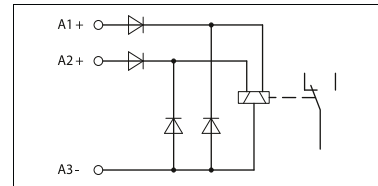

Basic structure of a bi-stable relay, positive switching type

Operating voltage range

The ambient temperature prevailing at the location of use has a major impact on certain relay operating parameters.

As the ambient temperature increases, the coil winding heats up, causing the operate and release voltages to rise. At the same time, the maximum permissible coil voltage decreases, which means that the usable working range becomes restricted as a result.

The diagram below illustrates how the operating voltage behaves as a function of the ambient temperature.

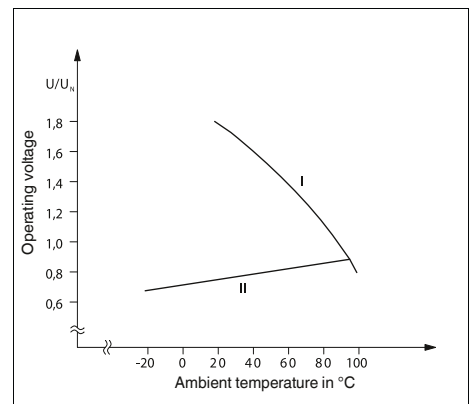

Basic curve of a relay operating voltage

- I: Maximum permissible voltage with 100% operating time (OT) and compliance with the coil temperature limit
- II: Minimum sparkover voltage

Interference voltages and interference currents on the coil side

When inductive or capacitive interference voltages are coupled into the long supply lines of a relay, this can prevent the relay from operating safely.

If the coupled-in voltage exceeds the release voltage required by the “relay standard”, IEC 61810-1, the relay may fail to release in extreme cases. In the case of

DC relays, this release voltage is $\geq 0.05 \times U_N$ and for purely AC relays, it is $\geq 0.15 \times U_N$.

The same disturbances can occur when a relay with a low input power is controlled by an electronics module with an AC voltage output featuring an RC circuit. The typical leakage current from RC elements of this kind (generally in the range of a few mA) provides sufficient control power to prevent the downstream relay from releasing or even enough power to excite it.

The disturbance level of any interference voltages that are present can be reduced by connecting an RC element in parallel to the relay coil. This measure also subjects the interference voltage to a capacitive load, causing it to collapse.

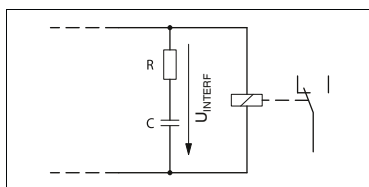

External RC interference suppressor to prevent interference voltage coupling

The following values are recommended for the purpose of dimensioning the RC element:

- R = 100 to 220 Ω
- C = 220 to 470 nF

The SO46 series has been developed to provide even higher levels of immunity to interference. These products already contain an integrated RCZ filter. See, for example, PLC...SO46.

Contact side, contact materials

Given the wide variety of potential applications in the different industrial sectors, the relays used must be matched to the various tasks that need to be performed by selecting the right kind of contact material.

The voltage, current, and power values play an important role when determining the suitability of contact materials. Other criteria include:

- Contact resistance
- Erosion resistance
- Material migration
- Welding tendency
- Chemical influences

In this way, the various contact materials (generally precious-metal alloys) can be matched to the relevant areas of application.

The adjacent table provides details of some of the key materials.

Contact protection circuit

Every electrical consumer constitutes a mixed load with resistive, capacitive, and inductive components.

Contact material	Typical properties	Typical applications	Guide values for the area of application*
Gold Au	Largely insensitive to industrial atmospheres, low and constant contact resistances in the range of small switching capacities with nickel (AuNi) or silver (AuAg) alloys.	Dry measuring and switching circuits, control inputs	$\mu\text{A} \dots 0.2 \text{ A}$ $\mu\text{V} \dots 30 \text{ V}$
Silver Ag	High electrical conductivity, sensitive to sulfur, therefore often gold-flashed (approximately 0.2 μm) as protection; nickel (AgNi) or copper (AgCu) alloys increase the mechanical resistance and erosion resistance and reduce the welding tendency.	Universal, suitable for medium loads; nickel alloys (AgNi 0.15) for DC circuits with medium to large loads	$\geq 12 \text{ V}$ $\geq 10 \text{ mA}$
Silver, hard gold-plated Ag + Au	Properties similar to gold Au, when switching loads $>30 \text{ V}/0.2 \text{ A}$, the hard gold plating (5 - 10 μm) is destroyed and the values and properties of the Ag contact are applicable. However, a reduction in the service life is then to be expected.	Suitable for control inputs and other small loads.	$\geq 100 \text{ mV}$ $\geq 1 \text{ mA}$
Tungsten W	Highest melting point, very high erosion resistance, greater contact resistances, very low welding tendency, susceptible to corrosion, often used as lead contact.	Loads with very high inrush currents, e.g., incandescent lamps, fluorescent lamps.	$\geq 60 \text{ V}$ $\geq 1 \text{ A}$
Silver nickel AgNi	High erosion resistance, low welding tendency, higher contact resistances than with pure silver.	Universal, suitable for medium to high loads, DC circuits, and inductive loads.	$\geq 12 \text{ V}$ $\geq 10 \text{ mA}$
Silver nickel AgNi + Au	Properties similar to gold Au, when switching loads $>30 \text{ V}/0.2 \text{ A}$, the hard gold plating (5 - 10 μm) is destroyed and the values and properties of the AgNi contact are applicable. However, a reduction in the service life is then to be expected.	Suitable for control inputs and other small loads.	$\geq 100 \text{ mV}$ $\geq 1 \text{ mA}$
Silver tin oxide AgSnO	Low welding tendency, very high erosion resistance for high switching capacities, low material migration.	Application depends heavily on the relay type, switching circuits with high make and break loads, e.g., incandescent lamps and fluorescent lamps, AC and DC circuits. Due to different alloys and production procedures, partly also suitable for smaller loads.	$\geq 12 \text{ V}$ $\geq 100 \text{ mA}$ ($\geq 10 \text{ mA}$)
Silver tin oxide, hard gold-plated AgSnO + Au	Properties similar to gold Au, when switching loads $>30 \text{ V}/0.2 \text{ A}$ the hard gold plating (5 - 10 μm) is destroyed and the values and properties of the AgSnO contact are applicable. However, a reduction in the service life is then to be expected.	Suitable for control inputs and other small loads.	$\geq 100 \text{ mV}$ $\geq 1 \text{ mA}$

* Values depend on the relay used and on further operating conditions.

When these loads are switched, the switching contact is in turn subjected to a load, to either a lesser or greater extent. This load can be reduced by including a suitable contact protection circuit.

In view of the fact that consumers with a large inductive component are predominantly used in practice (e.g., contactors, solenoid valves, motors, etc.), these application scenarios are worth considering in more detail.

On interruption, voltage peaks with values of up to several thousand volts occur due to the energy stored in the coil.

These high voltages cause an electric arc on the switching contact which can destroy

the contact due to material vaporization and material migration. The electrical service life is reduced considerably as a result. In extreme cases, the relay may fail in the very first switching cycle with DC voltage and a static electric arc.

A protective circuit must be used to suppress the formation of an electric arc. With optimum dimensioning, almost the same number of switching cycles can be achieved as with a resistive load.

Basics of relay technology

In principle, there are a number of possible ways of achieving an effective circuit:

1. Wiring the contact
2. Wiring the consumer
3. Combination of both wiring methods.

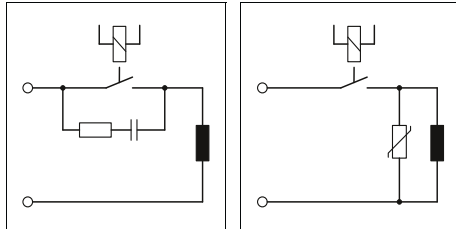

Wiring the contact

Wiring the inductive consumer

In principle, protective measures should intervene directly at the source of the interference.

Wiring a consumer should therefore be given priority over wiring the contact.

The following points are advantageous for the consumer circuit (image on right):

1. The circuit is only loaded with the induction voltage during interruption. By contrast, the sum of the operating voltage and the induction voltage is applied to the contact circuit.
2. When the contact is open, the load is electrically isolated from the operating voltage.
3. It is not possible for the load to be activated or to “stick” due to undesired operating currents, e.g., from RC elements.
4. Cut-off peaks of the load cannot be coupled into parallel control lines.

Nowadays, solenoid valves are usually connected using valve connectors that are also supplied with LEDs and components that limit the induction voltage. Valve connectors with an RC element, varistor or Zener diode often do not quench the arc and only serve to comply with legislation governing EMC. Only valve connectors with an integrated 1N4007 freewheeling diode quench the arc quickly and safely, thereby increasing the service life of the relay by a factor of 5 to 10. Valve connectors with LED, integrated 1N4007, and free cable end can be supplied on request as part of the SAC range.

Load wiring	Additional dropout delay	Defined induction voltage limitation	Effective bipolar attenuation	Advantages and disadvantages
Diode 	Large	Yes (U_D)	No	Advantages: <ul style="list-style-type: none"> • Good effect in terms of extending the service life of the contacts • Easy implementation • Inexpensive • Reliable • Dimensioning not critical • Low induction voltage Disadvantages: <ul style="list-style-type: none"> • Attenuation only via load resistor • Long dropout delay
Series connection diode/Zener diode 	Medium to small	Yes (U_{ZD})	No	Advantages: <ul style="list-style-type: none"> • Dimensioning not critical Disadvantages: <ul style="list-style-type: none"> • Attenuation only above U_{ZD} • Minimal effect in terms of extending the service life of the contacts
Suppressor diode 	Medium to small	Yes (U_{ZD})	Yes	Advantages: <ul style="list-style-type: none"> • Inexpensive • Dimensioning not critical • Limitation of positive peaks • Suitable for AC voltage Disadvantages: <ul style="list-style-type: none"> • Attenuation only above U_{ZD} • Minimal effect in terms of extending the service life of the contacts
Varistor 	Medium to small	Yes (U_{VDR})	Yes	Advantages: <ul style="list-style-type: none"> • High energy absorption • Dimensioning not critical • Suitable for AC voltage Disadvantages: <ul style="list-style-type: none"> • Attenuation only above U_{VDR} • Minimal effect in terms of extending the service life of the contacts
R/C combination 	Medium to small	No	Yes	Advantages: <ul style="list-style-type: none"> • HF attenuation due to energy storage • Suitable for AC voltage • Level-independent attenuation Disadvantages: <ul style="list-style-type: none"> • Precise dimensioning required • High inrush current surge • Minimal effect in terms of extending the service life of the contacts

Switching small loads

Small loads have to be processed mainly in applications where signals have to be forwarded to control inputs (e.g., of a PLC).

With these loads, no switching sparks (electric arcs) occur on the contacts in the small load range.

In addition to the constant cleaning effect due to contact friction, this switching spark assumes the function of penetrating non-conductive contamination layers that are formed on the contact surfaces of power contacts.

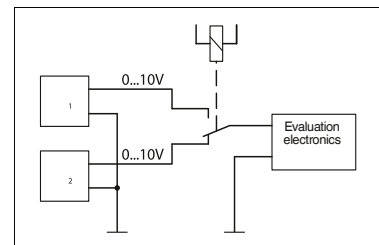

Application example: Measurement point changeover

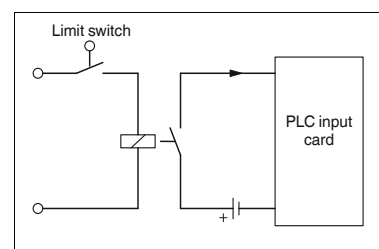

Application example: PLC input signal

These contamination layers are usually oxidation or sulfidation products of the contact materials silver (Ag) or silver alloys such as silver nickel (AgNi) or silver tin oxide (AgSnO). As a result, the contact resistance may rise so considerably within a short time that reliable switching is no longer possible in the case of small loads.

Due to these properties, the power contact materials mentioned are not suitable for small load applications.

Gold (Au) has become accepted as the contact material of choice for these areas of application mainly on account of its low and constant contact resistances even with small loads and its insensitivity to sulfurous atmospheres.

For the smallest of loads and even greater contact reliability, double contact relays with gold contacts are used.

The slotted contact spring in this design provides two parallel contact points with even lower contact resistances and considerably higher contact reliability.

Switching large loads

A few important points also need to be considered with regard to switching operations in the large load range that involve power contacts made of either silver (Ag) or silver tin oxide (AgSnO).

A basic distinction must be made between switching DC and AC loads.

Switching large AC loads

When switching large AC loads, the relay can be operated up to the corresponding maximum values for switching voltage, current, and power. The electric arc that occurs during interruption depends on the current, voltage, and phase relation. This cut-off arc usually disappears automatically the next time the load current passes through zero.

In applications with an inductive load, an effective protective circuit must be provided, otherwise the service life of the system will be reduced considerably.

Switching large DC loads

Conventional switching relays can only switch off relatively small direct currents (which contrasts with their ability to switch off the maximum permissible AC current), since there is no zero crossing to extinguish the arc automatically. This maximum DC value is also dependent to a large extent on the switching voltage and is determined, among other things, by constructional features such as contact spacing and contact opening speed.

The corresponding current and voltage values are documented by relay manufacturers in electric arc or load limit curves.

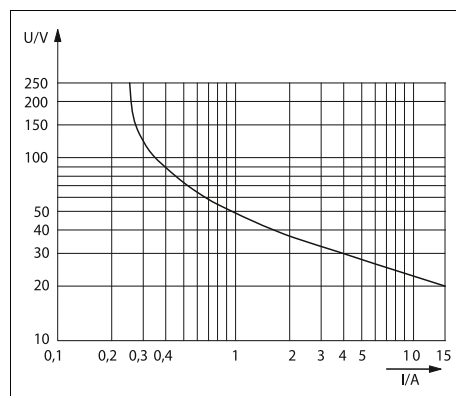

Example of a load limit curve (dependent on the type)

A non-attenuated inductive DC load further reduces the values given for switchable currents. The energy stored in the inductance can cause an electric arc to occur, which forwards the current through the open contacts.

With an effective contact protection circuit, preferably freewheeling diodes of the type 1N4007, the service life can be increased by a factor of 5 to 10 in relation to unprotected or unfavorably protected inductive loads (see also chapter Contact Protection Circuits).

If higher DC loads than those documented are to be switched or if the electrical service life is to be increased, several contacts of a relay can be connected in series. See, for example, REL-IR... industrial relays.

Alternatively, solid-state relays with DC voltage output can also be used.

Switching lamps and capacitive loads

Regardless of the type of voltage, all kinds of lamps and loads with a capacitive component impose extreme requirements on the switching contacts. The moment it is switched on, in other words precisely in the dynamic chattering phase of the relay, extremely powerful current peaks occur.

These are often in the region of several tens of amps, and not infrequently are known to exceed 100 A, which results in welding of the contact. This can be remedied by using specially optimized "lamp load relays" that can cope with these inrush peaks. See, for example, PLC...IC type.

Switching capacity in accordance with utilization categories AC15 and DC13 (IEC 60947)

In practice, both the maximum interrupting rating for AC loads and the DC interruption values taken from the load limit curves provide only a rough guide for the choice of relay. In reality, this is insufficient, since real loads in the vast majority of industrial applications have inductive or capacitive components and the wiring of the loads can be totally different. As already described, this sometimes leads to considerable variations in terms of service life.

The IEC 60947 contactor standard seeks to avoid these disadvantages by dividing the loads into various utilization categories (DC13, AC15, etc.). This standard is also partly applied to relays. However, users must be aware of the fact that these values are only applicable in practice to a limited extent as well, since all DC13 and AC15 test loads are highly inductive and are also operated without any protective circuit at all (see "Contact protection circuit" section). Moreover, the switching capacity test in accordance with IEC 60947 only requires 6,060 switching cycles to be performed by way of a minimum requirement.

A much more reliable way to determine the switching capacity and the anticipated service life is to refer to the specific application data. Using a comprehensive data bank, the service life can be accurately estimated for most applications and, if necessary, suggestions for improvement can be made. In the case of critical applications, the user is advised to gather service life information based on empirical data.

Control side

Solid-state relays for various voltage and power levels are available from Phoenix Contact for use as interface modules designed to match process I/O devices to control, signaling, and regulating devices. The solid-state relay element which is actually located in the module is limited to one defined voltage range by virtue of its design. The current consumption on the input side fluctuates depending on the circuit architecture and voltage level.

A suitable input circuit is provided to accommodate all of the voltages required for industrial applications between 5 V and 230 V. The inputs for DC voltage and AC voltage must always be differentiated.

DC input

Adjustments are made in accordance with the various voltage levels by adding electronics which have been specially adapted to the desired voltage range. In the case of most modules, a polarity protection diode provides reliable protection against destruction in the event of a control voltage being connected incorrectly. Specially coordinated filters reliably suppress possible high-frequency noise emissions.

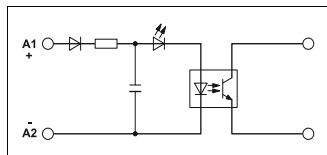

Figure 1: Block diagram for DC input

AC input

The solid-state relay element requires a stable control voltage to ensure reliable operation. In the case of the AC input, this is achieved by connecting a rectifier and filter capacitor upstream. The rectification is followed, in principle, by the same circuit architecture as the DC input.

The switching frequency always lies below half the mains frequency. Due to the filter capacitor, a higher switching frequency

cannot be achieved. This results in continuous through-switching.

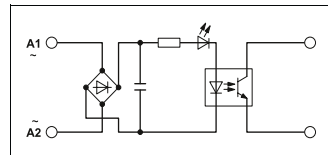

Figure 2: Block diagram for AC input

Load side

Depending on the application and the type of load, the solid-state relay output must meet various requirements. The following are crucial:

- Power amplification
- Matching the switching voltage and the switching current (AC/DC)
- Short-circuit protection

For these different applications, the solid-state relay element must also be processed using additional electronics on the output side.

DC output

In order to achieve the necessary output power, the solid-state relay element is supplemented by one or more semiconductor components.

The on-site user should nevertheless simply regard the connection terminal blocks of the output as conventional switch connections. Observing the specified polarity is the only essential requirement.

For practical reasons, the following criteria should be taken into account when selecting a suitable solid-state relay:

1. Operating voltage range (e.g., 12 ... 60 V DC).

This determines the minimum or maximum voltage to be switched.

The lower value must be observed in order to ensure reliable operation. In order to protect the output transistor, the upper value must not be exceeded.

2. Maximum continuous current (e.g., 1 A).

This value indicates the maximum continuous current. If this value is exceeded continuously, the output semiconductor will be destroyed.

The dependence of the output current on the ambient temperature of the solid-state relay should also be taken into consideration. A derating curve

is therefore generally specified for solid-state power relays. This shows the maximum load current as a function of the ambient temperature.

3. Output configuration.

The 2-conductor output is similar to a mechanical contact. Only the polarity of the connections is specified and must be observed.

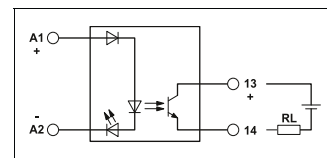

Figure 3: 2-conductor output

The 3-conductor output is non-isolated and requires both potentials from the voltage source on the output side to be connected if it is to operate reliably.

When switched off, a permanent reference to ground (negative potential) is established. In addition, this output circuit offers the advantage of an almost constant internal resistance.

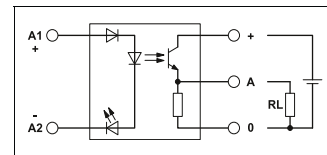

Figure 4: 3-conductor output

AC output

In order to control the switching and control devices for AC voltage, a semiconductor for AC voltage (TRIAC or thyristor) is connected downstream of the solid-state relay element.

As with the DC output, it is particularly important to consider the maximum operating voltage range and the maximum continuous load current as a function of the ambient temperature.

Basics of solid-state relay technology

In addition, the maximum peak reverse voltage of the TRIAC (e.g., 600 V) is crucial with AC outputs. This must not be exceeded even in the case of voltage fluctuations or interference voltage peaks in order to prevent destruction. That is why the AC outputs of all solid-state relays from Phoenix Contact have an internal RC protective circuit to protect against interference voltage peaks.

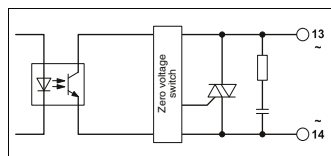

Figure 5: Basic circuit diagram of AC output

Protective circuits

The moment inductive loads (contactors, solenoid valves, motors) are switched off, surge voltages occur and these can reach very high amplitudes. Electronic components and switching elements are particularly susceptible to these. A protective circuit should therefore always be provided to prevent destruction.

A parallel connection to the load effectively reduces the switching surge voltage to a harmless level. Depending on the solid-state relay output and load type,

- a freewheeling diode/suppressor diode (DC only),
- a varistor (AC and DC)
- or an RC element (AC only)

can provide the necessary protection.

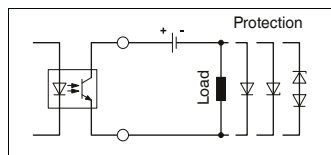

Figure 6: Protective circuit with DC voltage output

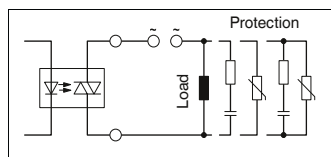

Figure 7: Protective circuit with AC voltage output

Application notes

Input solid-state relays acting in the direction from the I/O devices to the controller (signaling, controlling, monitoring)

Pluggable versions:

- PLC-O...

Modular versions:

- DEK-OE...
- EMG 10-OE...
- SIM-EI...
- OPT...

Output (power) solid-state relays acting in the direction from the controller to the I/O devices (switching, amplifying, controlling)

Pluggable versions:

- PLC-O...

Modular versions:

- DEK-OV...
- EMG 10-OV
- EMG 12-OV
- EMG 17-OV
- OV...
- OPT...

Example: Load protection monitoring (DC contactor)

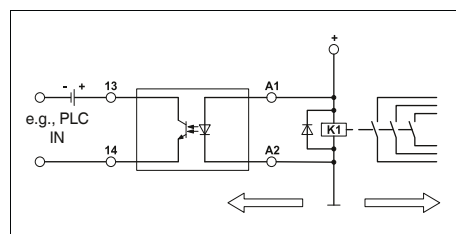

Example: Load protection monitoring (AC contactor)

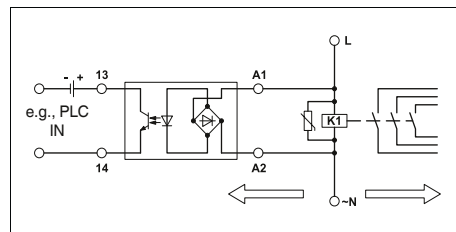

Example: Position indication with limit stop contact or initiator

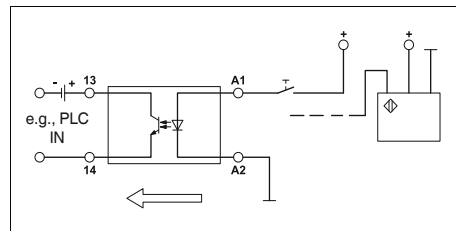

Example: Contactor, solenoid valve or motor (DC load) switching

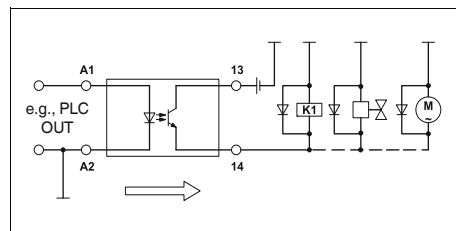

Example: Contactor, solenoid valve or motor (AC load) switching

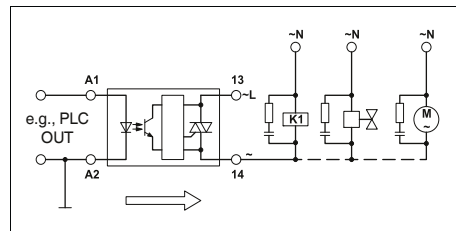

Remarks:

- 1) Ground (negative) potential from the input and output of the solid-state relay must not be connected.
- 2) DC loads must be provided with an effective protective circuit (e.g., diode).
- 3) AC loads must be protected with a varistor or an RC element.

Configuration aid for connecting sensors and actuators

Electromechanical relays or solid-state relays are used as the coupling element between the controller and the sensors or actuators in the field. This interface ensures appropriate signal conditioning with respect to current and voltage between the controller and field level.

Conventional connection of actuators

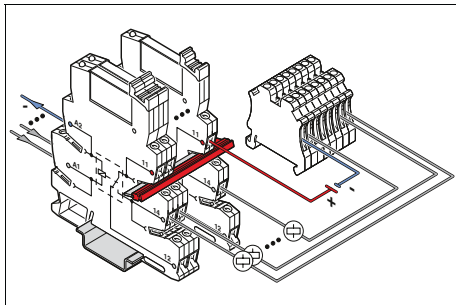

If actuators such as solenoid valves are connected to the controller via a universal relay with changeover contact, an additional terminal block strip must be used for the common load return line. The positive potential of the loads is applied to connection terminal block 11 (changeover contact) at the relay modules. This can be distributed over all relay modules using plug-in bridges. This means that only the direct connection of the potential to one relay is necessary. The loads are connected to connection terminal block 14 (N/O contact). The negative potential required is supplied at a terminal block. This is then distributed to further terminal blocks by means of plug-in bridges. However, load return lines for the individual actuators are applied to every terminal block. This results in a common load return line potential for all actuators via the additional terminal block.

Because of the increased space requirement and additional wiring to the terminal block, the use of additional terminal blocks for distributing potential requires a great deal of effort.

Easy wiring of actuators

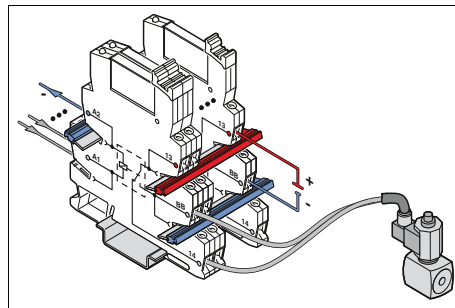

The PLC...ACT relay modules enable fast and easy connection of actuators. The positive potential of the loads is applied to connection terminal block 13. This can be distributed over all relay modules using plug-in bridges. This makes only the direct connection to one module necessary here as well. The actuators are connected to contact 14 (N/O contact). In the case of PLC...ACT relay modules, an N/C contact is not required. Instead, the BB connection serves as an option for connecting the load return line. Here the common negative potential is supplied and distributed by means of plug-in bridges. The terminal block for conventional wiring is not necessary due to the direct connection of the load return line potential to the relay module. This means that no additional space is required in the control cabinet and simpler wiring minimizes the risk of error.

Conventional connection of sensors

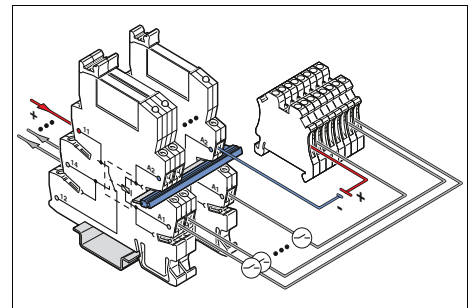

If sensors such as proximity switches are connected via a universal relay to a controller with a changeover contact, an additional terminal block strip must be used for the common sensor supply voltage. It is also important to note that either the wiring in the control cabinet must be implemented the other way round because control of the relay now takes place from the field level and not via the controller, or the relay module must be installed into the control cabinet rotated by 180°. The negative potential of the sensors is applied at connection terminal block A2 on the relay module. This can be distributed over all relay modules using plug-in bridges. This means that direct connection to only one relay is necessary. The sensors are connected to connection terminal block A1. The necessary positive potential is supplied to a terminal block and distributed to further terminal blocks by means of plug-in bridges. However, the supply for the individual sensors is applied to every terminal block. This results in a common supply signal for all sensors via the additional terminal blocks.

Because of the increased space requirement and additional wiring to the terminal block, the use of additional terminal blocks for distributing potential requires a great deal of effort.

Configuration aid for handling interference signals

Easy wiring of sensors

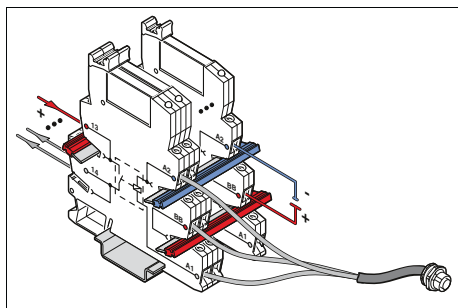

Sensors can be efficiently coupled with the controller with the PLC...SEN relay modules. The input and output side on the module are already interchanged so that the signal direction from the field to the controller can be ideally represented. Therefore, three connection terminal blocks (A1, A2, and BB) are located on the control side of the relay. The common negative potential of the sensors is connected to A2 and distributed to further relay modules by means of plug-in bridges. The sensors are connected directly to the A1 connections. Connection BB is used for the common supply potential of the sensors. The potential is distributed to all connected sensors by means of the plug-in bridges. However, only connections 13 and 14 for the N/O contact are located on the contact side. Signal feedback to the controller takes place over these contacts. The terminal block for conventional wiring can be dispensed with, thanks to the direct connection of the sensor supply voltage to the relay module. This means that no additional space is required in the control cabinet and simpler wiring minimizes the risk of error.

In accordance with IEC 61810-1, the standard release voltage of a relay is 5% of the nominal voltage for DC coils and 15% for AC coils. That means that a relay with a nominal voltage of 230 V AC is only switched off when the control voltage is $0.15 \times 230 \text{ V AC} = 34.5 \text{ V AC}$. If interference signals occur on the control side of a relay that are greater than the release voltage, defined switch-off is no longer possible. In the worst case, the interference is large enough to energize the relay. The application is still switched on although no signal is issued by the controller. There can be various reasons for this.

Coupling of interference signals from parallel lines

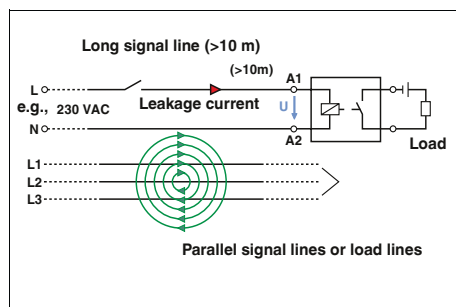

If the control lines to the relay are very long, interference can occur from cables running in parallel. These influence the actual control line and couple the signals to it. This interference voltage can be measured on the control side, even if no signal is issued by the controller.

Leakage current with AC voltage output card

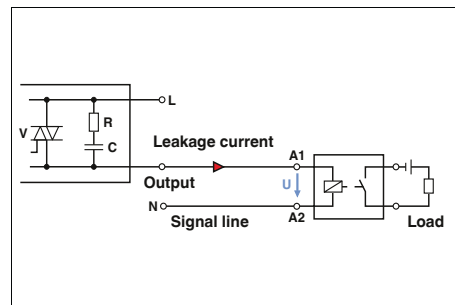

Leakage current on the signal line occurs if control of a relay takes place via an output card with AC voltage. This is caused by the RC wiring of the AC voltage output. Typically, the leakage current has a control power that is large enough not to switch off the relay reliably.

Safe shutdown even with interference signals

The PLC...SO46 series is equipped with RCZ wiring in the base. The release voltage of the relay is increased by this circuit of resistor, capacitor, and Zener diode so that the relay is resistant to interference voltages. In the case of a relay for 230 V AC, the standard release voltage is 34.5 V AC. The PLC...230UC...SO46 modules have a release voltage of 80 V AC. This enables the relay to switch off reliably at interference voltages of 80 V AC. The PLC...SO46 bases are also available with further voltages. They can be fitted with both electromechanical relays or solid-state relays. Screw connection or Push-in connection is available as the connection technology.

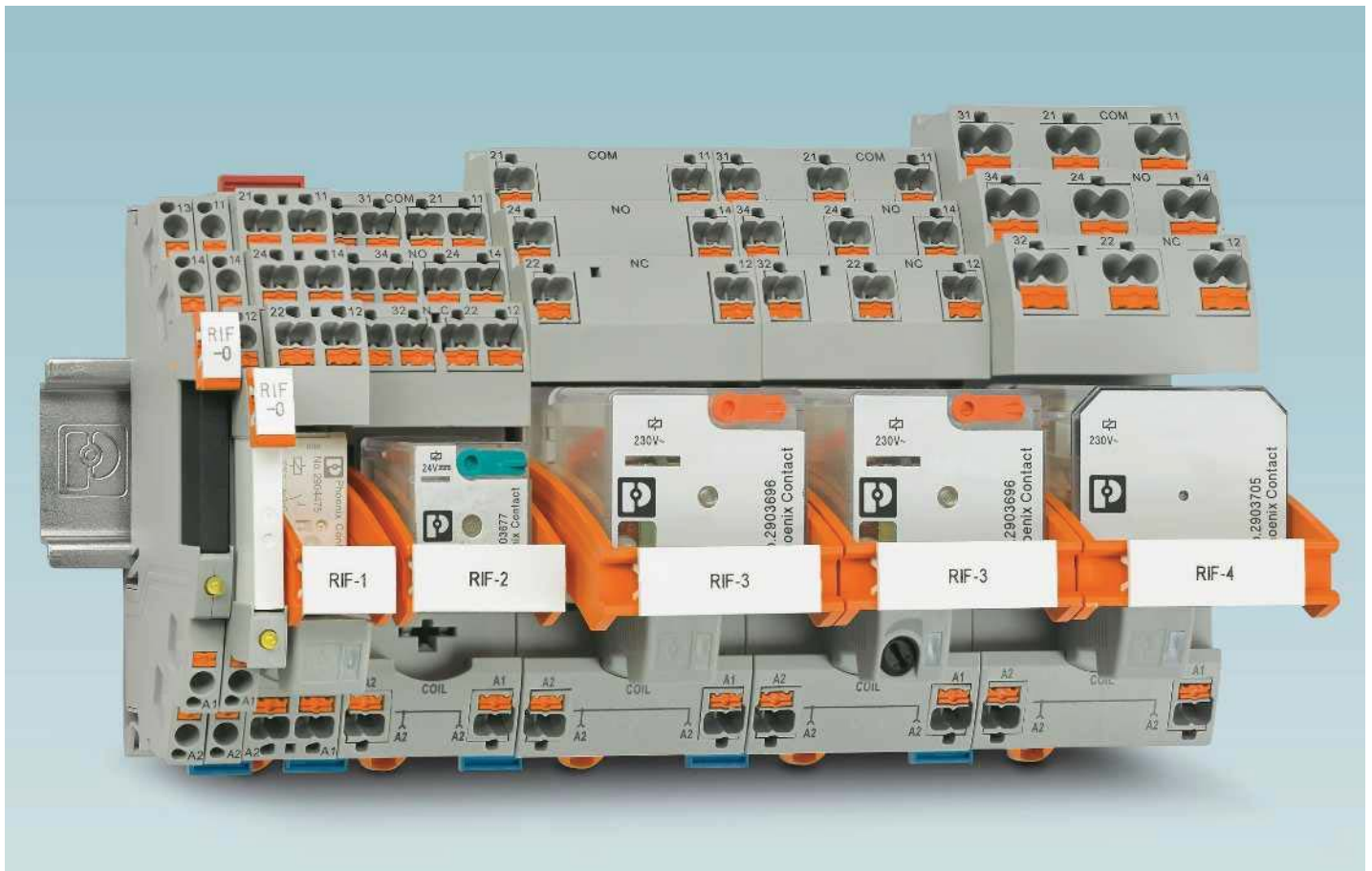

RIFLINE complete is a cost-effective relay system with various accessories. It consists of DIN rail bases, electromechanical or solid-state relays, plug-in interference suppression modules, marking material, and bridging material. The range of accessories is rounded off with a timer module. This is used to transform a basic relay into a timer relay with three different functions.

The RIFLINE complete relay range consists of seven different base versions from RIF-0 to RIF-4 – these range from one N/O contact up to four PDT contacts. The field of application of this product group ranges from coupling relay applications with switching currents of one milliamp to replacement for miniature contactors with currents up to 16 A.

The relay bases feature Push-in or screw connection technology. Push-in connection technology enables quick and tool-free conductor contacting. The RIF-1 to RIF-4 bases offer double the contact options on both the input and output side.

On the input side of all bases, the negative potential (A2) can be bridged – regardless of the base size. On the output side, the grouped contact (11) can be bridged within the RIF-0 base version. This connection can also be bridged within the RIF-1 base size.

To offer diverse marking options, the engagement lever can be fitted with a zack marker strip. In addition, marker carriers

can be mounted on the bases so that additional marking surfaces are available.

RIFLINE complete can be extended using many elements from the CLIPLINE complete accessories range. This includes marking material, bridges, and test adapters.

To make ordering and management easier, RIFLINE complete modules are provided in the most popular voltages as complete modules with relay and interference suppression module. For individual assembly, tailored to the requirements of the application, additional voltage levels are offered in the modular system.



RIF-0

The 6.2 mm narrow RIF-0 base series is suitable for a 1-changeover-contact relay. Switching currents up to 6 A are implemented here. Two base versions are available: 1 N/O contact and 1 changeover contact. RIF-0 is therefore a good choice for all coupling applications.



RIF-1

The 16 mm narrow RIF-1 base series is suitable for a 2-changeover-contact relay. Currents up to 13 A can be switched when using the FBS 2-8 plug-in bridge. This relay is ideal for power switching and signal duplication.



RIF-2

The 31 mm wide RIF-2 base series is designed for industrial relays with up to 4 contacts. Currents up to 12 A are no problem for these bases. This relay is ideal for applications that require power and signal multiplication.



RIF-3

The 40 mm wide RIF-3 base series is designed for octal relays with up to 3 contacts. Switching currents up to 10 A are implemented here. Two base versions are available: 2 changeover contacts and 3 changeover contacts. RIF-3 bases are ideal for all applications that require power and signal multiplication.



RIF-4

The 43 mm wide RIF-4 base series is designed for power relays with up to 3 contacts. Currents up to 16 A can be switched. RIF-4 bases are a good choice for applications that require power and signal multiplication, e.g., in miniature contactor applications.

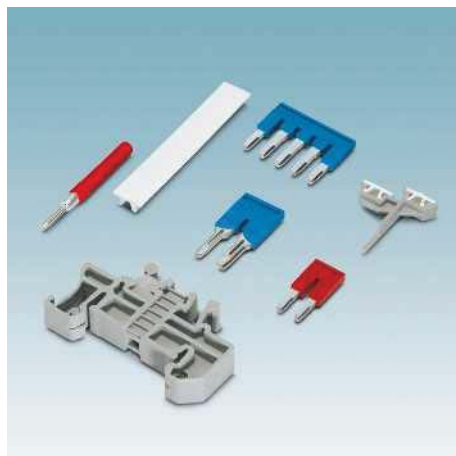

Accessories

A wide range of accessories are available for the RIFLINE complete relay system that round off the range. These include bridges, professional marking material, special function modules, test plugs, and end brackets.

RIFLINE complete – Industrial relay system

Modular RIF-0 relay bases

Relay bases that can be fitted with miniature power relays or solid-state relays with a nominal voltage of 12 to 24 V DC.

The advantages:

- Integrated freewheeling diode for input circuit and interference suppression circuit
- LED for status display
- Safe isolation in accordance with DIN EN 50178 between coil and contact
- Professional marking material
- Holders for test plugs
- Professional bridging of adjacent modules saves wiring time (A2 and 11/13)
- FBS 2-6 plug-in bridges for the input and output side

Notes:
Type of insulating housing: Polyamide PA non-reinforced, color: gray.
For further marking systems and mounting material, see Catalog 3.
When mounting relays on a DIN rail base or PCB, data may be limited, especially with regard to the limiting continuous current and/or ambient temperature range. See "General" section in "Fundamentals of relay technology" on page 272

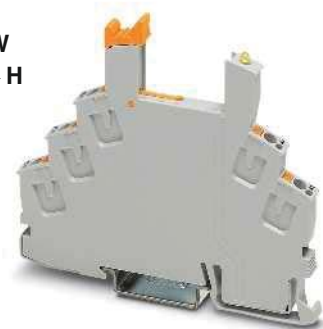

1-changeover-contact relay base with Push-in connection technology



Technical data

250 V AC/DC (contact side)
Max. 8 A (depends on application/assembly)

-40°C ... 85°C (depends on application/assembly)

0.14 ... 1.5 mm² / 0.14 ... 1.5 mm² / 24 - 16

-
6.2 mm
78 mm
93 mm

Nominal voltage U_N
Nominal current at U_N

General data

Ambient temperature (operation)

Connection data solid/stranded/AWG

Maximum tightening torque

Dimensions

Width

Depth

Height

Ordering data

Description

RIF-0 relay base, PDT version, safe isolation I/O
With Push-in connection

RIF-0 relay base, N/O contact version, safe isolation I/O
With Push-in connection

RIF-0 relay base, PDT version, safe isolation I/O
With screw connection

RIF-0 relay base, N/O contact version, safe isolation I/O
With screw connection

RIF-0 relay base, negative switching, PDT version,
safe isolation I/O
With Push-in connection

Type	Order No.	Pcs./Pkt.
RIF-0-BPT/21	2900958	10
RIF-0-BPT-M/ 21	2907468	10

Accessories

Plug-in bridge

2-pos. red, 24 A
2-pos. red, 32 A
2-pos. blue, 32 A
2-pos. gray, 32 A
3-pos. red, 24 A
4-pos. red, 24 A
5-pos. red, 24 A
5-pos. red, 32 A
10-pos. red, 32 A
20-pos. red, 32 A
50-pos. red, 32 A

End clamp, to snap on NS 35, 9.5 mm wide, can be labeled with ZB 6, ZB 8/27, KLM...

Test plug, consisting of:

Metal part for 2.3 mm Ø socket hole and gray

Insulating sleeve, for MPS metal part

red
white
blue
yellow
green
gray
black

Zack marker strip, unprinted, 10-section: each pack contains enough to label 100 terminal blocks

10-section

FBSR 2-6	3033715	50
FBS 2-6	3030336	50
FBS 2-6 BU	3036932	50
FBS 2-6 GY	3032237	50
FBSR 3-6	3001594	50
FBSR 4-6	3001595	50
FBSR 5-6	3001596	50
FBS 5-6	3030349	50
FBS 10-6	3030271	10
FBS 20-6	3030365	10
FBS 50-6	3032224	10
CLIPFIX 35	3022218	50
MPS-MT	0201744	10
MPS-IH RD	0201676	10
MPS-IH WH	0201663	10
MPS-IH BU	0201689	10
MPS-IH YE	0201692	10
MPS-IH GN	0201702	10
MPS-IH GY	0201728	10
MPS-IH BK	0201731	10
ZB 6:UNBEDRUCKT	1051003	10

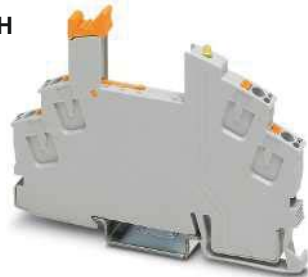

1 N/O contact relay base for Miniature power relay

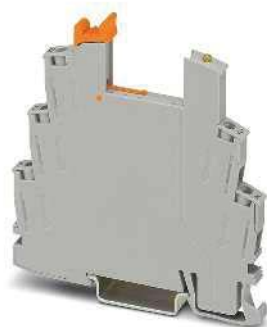

1-changeover-contact relay base with screw connection technology

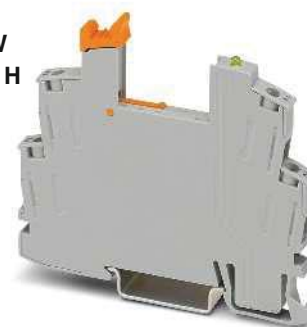

1-N/O-contact relay base with screw connection technology



Technical data

250 V AC/DC (contact side)
Max. 8 A (depends on application/assembly)

-40°C ... 85°C (depends on application/assembly)

0.14 ... 1.5 mm² / 0.14 ... 1.5 mm² / 24 - 16

6.2 mm
66 mm
93 mm

Technical data

250 V AC/DC (contact side)
Max. 8 A (depends on application/assembly)

-40°C ... 85°C (depends on application/assembly)

0.5 ... 4 mm² / 0.5 ... 2.5 mm² / 20 - 12
0.6 Nm

6.2 mm
82 mm
84 mm

Technical data

250 V AC/DC (contact side)
Max. 8 A (depends on application/assembly)

-40°C ... 85°C (depends on application/assembly)

0.5 ... 4 mm² / 0.5 ... 2.5 mm² / 20 - 12
0.6 Nm

6.2 mm
68 mm
84 mm

Ordering data

Type	Order No.	Pcs./Pkt.
RIF-0-BPT/1	2901873	10

Ordering data

Type	Order No.	Pcs./Pkt.
RIF-0-BSC/21	2900957	10

Ordering data

Type	Order No.	Pcs./Pkt.
RIF-0-BSC/ 1	2901872	10

Accessories

FBSR 2-6	3033715	50
FBS 2-6	3030336	50
FBS 2-6 BU	3036932	50
FBS 2-6 GY	3032237	50
FBSR 3-6	3001594	50
FBSR 4-6	3001595	50
FBSR 5-6	3001596	50
FBS 5-6	3030349	50
FBS 10-6	3030271	10
FBS 20-6	3030365	10
FBS 50-6	3032224	10
CLIPFIX 35	3022218	50
MPS-MT	0201744	10
MPS-IH RD	0201676	10
MPS-IH WH	0201663	10
MPS-IH BU	0201689	10
MPS-IH YE	0201692	10
MPS-IH GN	0201702	10
MPS-IH GY	0201728	10
MPS-IH BK	0201731	10
ZB 6:UNBEDRUCKT	1051003	10

Accessories

FBSR 2-6	3033715	50
FBS 2-6	3030336	50
FBS 2-6 BU	3036932	50
FBS 2-6 GY	3032237	50
FBSR 3-6	3001594	50
FBSR 4-6	3001595	50
FBSR 5-6	3001596	50
FBS 5-6	3030349	50
FBS 10-6	3030271	10
FBS 20-6	3030365	10
FBS 50-6	3032224	10
CLIPFIX 35	3022218	50
MPS-MT	0201744	10
MPS-IH RD	0201676	10
MPS-IH WH	0201663	10
MPS-IH BU	0201689	10
MPS-IH YE	0201692	10
MPS-IH GN	0201702	10
MPS-IH GY	0201728	10
MPS-IH BK	0201731	10
ZB 6:UNBEDRUCKT	1051003	10

Accessories

FBSR 2-6	3033715	50
FBS 2-6	3030336	50
FBS 2-6 BU	3036932	50
FBS 2-6 GY	3032237	50
FBSR 3-6	3001594	50
FBSR 4-6	3001595	50
FBSR 5-6	3001596	50
FBS 5-6	3030349	50
FBS 10-6	3030271	10
FBS 20-6	3030365	10
FBS 50-6	3032224	10
CLIPFIX 35	3022218	50
MPS-MT	0201744	10
MPS-IH RD	0201676	10
MPS-IH WH	0201663	10
MPS-IH BU	0201689	10
MPS-IH YE	0201692	10
MPS-IH GN	0201702	10
MPS-IH GY	0201728	10
MPS-IH BK	0201731	10
ZB 6:UNBEDRUCKT	1051003	10

Plug-in miniature power relays

Plug-in relays with one changeover contact, suitable for RIF-0 and PLC-INTERFACE relay bases.

The advantages:

- Power contacts up to 6 A
- Multi-layer gold contact or power contact
- High degree of protection, RT III (wash-proof), or RT II for relay with one changeover contact with manual operation
- Safe isolation in accordance with DIN EN 50178 between coil and contact
- Can be soldered in on PCB



Relay with one changeover contact, max. 6 A



Relay with one changeover contact, with manual operation, max. 6 A

Notes:

If the specified maximum values for multi-layer contact relays are exceeded, the gold plating is destroyed. The maximum values of the power contact relay are then valid. This can result in a shorter service life than with a pure power contact.

For dimensional drawings and perforations for assembly, see page 400

When mounting relays on a DIN rail base or PCB, data may be limited, especially with regard to the limiting continuous current and/or ambient temperature range. See "General" section in "Fundamentals of relay technology" on page 272

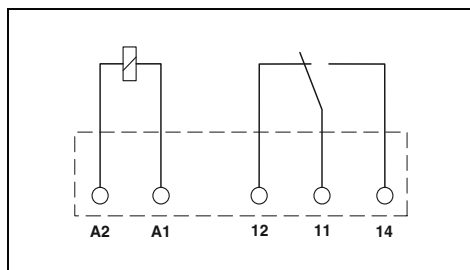

Technical data

①	②
See diagram	
14	7
5	5
2.5	2.5
1 PDT	
AgSnO, hard gold-plated	
250 V AC/DC	
30 V AC / 36 V DC	
5 V (at 100 mA)	
100 mV (at 10 mA)	
6 A	
50 mA	
10 A (4 s)	
50 mA	
10 mA (at 12 V)	
1 mA (at 24 V)	

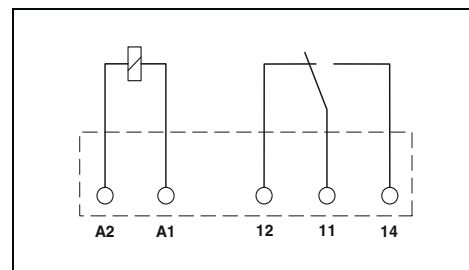

Technical data

①	②
See diagram	
14	7
5	5
2.5	2.5
1 PDT	
AgSnO, hard gold-plated	
250 V AC/DC	
30 V AC / 36 V DC	
5 V (at 100 mA)	
100 mV (at 10 mA)	
6 A	
50 mA	
10 A (4 s)	
50 mA	
10 mA (at 12 V)	
1 mA (at 24 V)	

Input data	
Permissible range (with reference to U_N)	
Typical input current at U_N	[mA]
Typical response time at U_N	[ms]
Typical release time at U_N	[ms]
Output data	
Contact type	
Contact material	
Max. switching voltage	
Minimum switching voltage	
Limiting continuous current	
Maximum switch-on current	
Minimum switching current	
General data	
Test voltage (winding/contact)	
Ambient temperature (operation)	
Nominal operating mode	
Mechanical service life	
Standards/regulations	
Mounting position/mounting	
Dimensions	W / H / D

4 kV AC (50 Hz, 1 min.)
-40°C ... 85°C
100% operating factor
2x 10 ⁷ cycles
IEC 60664, EN 50178, EN 61810-1
Any / in rows with zero spacing
5 mm / 28 mm / 15 mm

4 kV AC (50 Hz, 1 min.)
-40°C ... 85°C
100% operating factor
1x 10 ⁷ cycles
IEC 60664, EN 50178, EN 61810-1
Any / in rows with zero spacing
5 mm / 28 mm / 16 mm

Ordering data	
Description	Input voltage U_N
Plug-in miniature power relays, with power contacts	
①	12 V DC
②	24 V DC
Plug-in miniature power relays, with multi-layer gold contacts	
①	12 V DC
②	24 V DC

Type	Order No.	Pcs./Pkt.
REL-MR- 12DC/21	2961150	10
REL-MR- 24DC/21	2961105	10
REL-MR- 12DC/21AU	2961163	10
REL-MR- 24DC/21AU	2961121	10

Type	Order No.	Pcs./Pkt.
REL-MR- 12DC/21/MS	2909641	10
REL-MR- 24DC/21/MS	2909642	10
REL-MR- 12DC/21AU/MS	2909644	10
REL-MR- 24DC/21AU/MS	2909645	10

REL-MR-.../21... (1 changeover contact)

Input voltage range

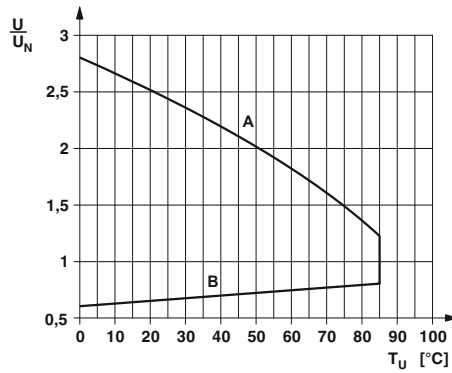

Interrupting rating

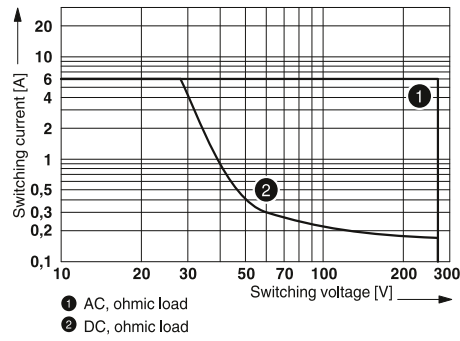

REL-MR-.../21.../MS (1 changeover contact)

Input voltage range

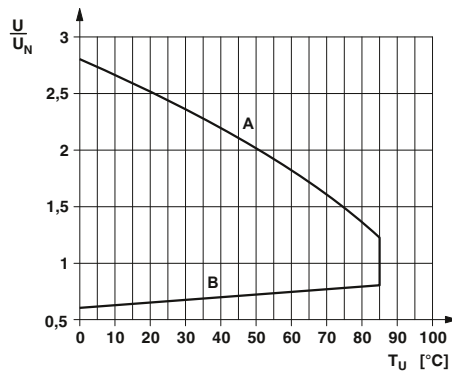

Interrupting rating

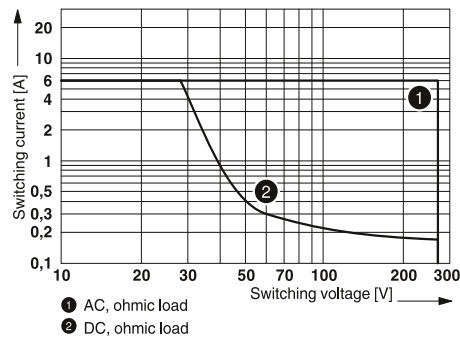

Plug-in solid-state relays

Plug-in solid-state relays suitable for RIF-0 and PLC-INTERFACE relay bases.

The advantages:

- Switching current of up to 3 A
- RT III seal (wash-proof)
- Vibration- and shock-resistant
- Wear-free and long-lasting
- Zero voltage switch at AC output
- Can be soldered in on PCB

Notes:

For dimensional drawings and perforations for assembly, see page 401

When mounting relays on a DIN rail base or PCB, data may be limited, especially with regard to the limiting continuous current and/or ambient temperature range. See "General" section in "Fundamentals of relay technology" on page 272



Solid-state relay,
DC output max. 3 A

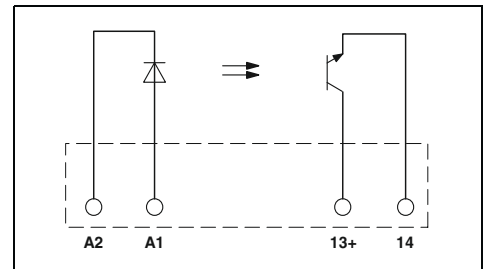

Technical data

Input data	①
Permissible range (with reference to U_N)	0.8 - 1.2
Switching level	1 signal ("H") [V DC] \geq 16 0 signal ("L") [V DC] \leq 10
Typical input current at U_N	[mA] 7
Typical switch-on time at U_N	[μ s] 20
Typical switch-off time at U_N	[μ s] 300
Transmission frequency f_{limit}	[Hz] 300
Output data	
Max. switching voltage	33 V DC
Minimum switching voltage	3 V DC
Limiting continuous current	3 A (see derating curve)
Minimum load current	-
Maximum switch-on current	15 A (10 ms)
Leakage current in off state	-
Phase angle (cos ϕ)	-
Output circuit	2-conductor, floating
Max. load value	-
Output protection	Reverse polarity protection, surge protection
Voltage drop at maximum limiting continuous current	\leq 150 mV
General data	
Rated surge voltage	Basic insulation
Test voltage input/output	2.5 kV (50 Hz, 1 min.)
Ambient temperature (operation)	-25°C ... 60°C
Nominal operating mode	100% operating factor
Standards/regulations	IEC 60664, EN 50178
Degree of pollution/surge voltage category	2 / III
Mounting position/mounting	Any / in rows with zero spacing
Dimensions	W / H / D 5 mm / 28 mm / 15 mm

Ordering data

Description	Input voltage U_N	Type	Order No.	Pcs./Pkt.
Plug-in solid-state relays				
Solid-state power relays	① 24 V DC	OPT-24DC/ 24DC/ 2	2966595	10
Plug-in solid-state relays				
Solid-state input relays	① 24 V DC			



**Solid-state relay,
DC output max. 100 mA**



**Solid-state relay,
AC output max. 750 mA**

Derating curve for OPT...DC/24DC/2 and PLC-OS.../24DC/2 solid-state relays

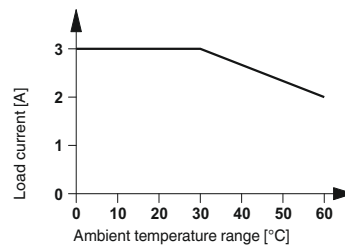

Derating curve for OPT...DC/230AC/1 and PLC-OS.../230AC/1 solid-state relays

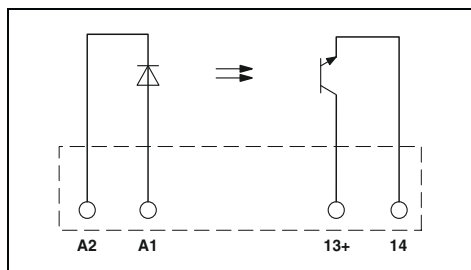
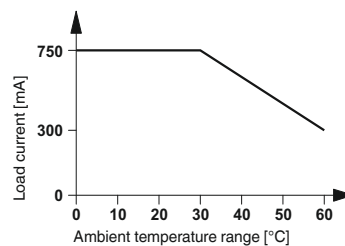

Technical data

①

0.8 -
1.2
16
10
7
20
300
300

48 V DC
3 V DC
100 mA

-
-
-
-
2-conductor, floating
-

Reverse polarity protection, surge protection
≤1 V

Basic insulation
2.5 kV (50 Hz, 1 min.)
-25°C ... 60°C
100% operating factor
IEC 60664, EN 50178

2 / III
Any / in rows with zero spacing
5 mm / 28 mm / 15 mm

Ordering data

Type	Order No.	Pcs./Pkt.
OPT-24DC/ 48DC/100	2966618	10

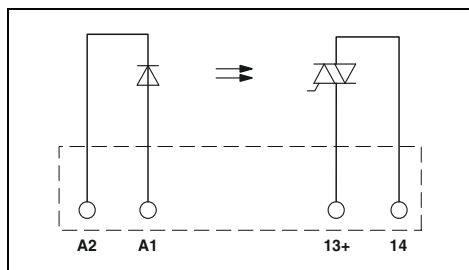

Technical data

①

0.8 -
1.2
10
5
6
6,000
500
10

253 V AC
24 V AC
0.75 A (see derating curve)
10 mA
30 A (10 ms)
<1 mA
0.5
2-conductor floating, zero voltage switch
4.5 A²s
RCV circuit
<1 V

Basic insulation
2.5 kV (50 Hz, 1 min.)
-25°C ... 60°C
100% operating factor
IEC 60664, EN 50178
2 / III
Any / in rows with zero spacing
5 mm / 28 mm / 15 mm

Ordering data

Type	Order No.	Pcs./Pkt.
OPT-24DC/230AC/ 1	2967950	10

RIFLINE complete – Industrial relay system

Modular RIF-1 relay bases

Relay bases that can be fitted with 1 or 2 PDT relays or solid-state relays.

Range of accessories includes:

- Plug-in interference suppression module
- Plug-in timer module
- Relay retaining bracket with ejector function and holder for marking material
- Comprehensive range of marking material
- Test plug
- FBS 2-6 plug-in bridges for the input side (A2)
- FBS 2-8 plug-in bridges for the output side (11/21)

Notes:
Type of insulating housing: Polyamide PA non-reinforced, color: gray.
For further marking systems and mounting material, see Catalog 3.
When mounting relays on a DIN rail base or PCB, data may be limited, especially with regard to the limiting continuous current and/or ambient temperature range. See "General" section in "Fundamentals of relay technology" on page 272

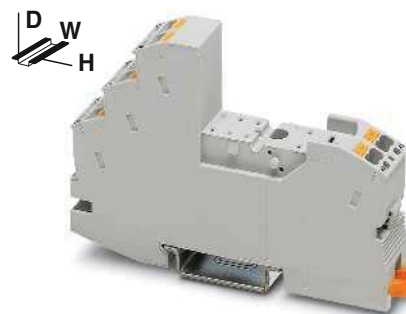

2-changeover-contact relay base with Push-in connection technology



Nominal voltage U_N
Nominal current at U_N

General data
Ambient temperature (operation)
Connection data solid/stranded/AWG
Dimensions
Width
Depth with retaining bracket
Height

Technical data

250 V AC/DC
Max. 13 A (depends on application/assembly)

-40°C ... 85°C (depends on application/assembly)

0.14 ... 1.5 mm² / 0.14 ... 1.5 mm² / 26 - 16

16 mm

75 mm

96 mm

Description
RIF-1 relay base , plug-in option for interference suppression module, safe isolation I/O with Push-in connection
RIF-1 relay base , plug-in option for interference suppression module, safe isolation I/O with screw connection
Relay retaining bracket , with ejector function and holder for marking material, suitable for RIF-1 relay base
- for 16 mm high miniature power and solid-state relays
- for 25 mm high miniature power relays
Relay retaining bracket , wire model, suitable for RIF-1 relay base
- for 16 mm high miniature power and solid-state relays
- for 25 mm high miniature power relays

Ordering data

Type	Order No.	Pcs./Pkt.
RIF-1-BPT/2X21	2900931	10

Plug-in bridge	
2-pos. red, 32 A	
2-pos. red, 24 A	
2-pos. red, 32 A	
2-pos. blue, 32 A	
2-pos. gray, 32 A	
2-pos. red, 41 A	
2-pos. blue, 41 A	
2-pos. gray, 41 A	
End clamp , to snap on NS 35, 9.5 mm wide, can be labeled with ZB 6, ZB 8/27, KLM...	
Test plug , consisting of:	
Metal part for 2.3 mm Ø socket hole and	gray
Insulating sleeve , for MPS metal part	red white blue yellow green gray black
Zack marker strip , unprinted	
10-section	
5-section	
Double marker carrier for ZB 5	

Accessories

FBS 2-6	3030336	50
FBSR 2-6	3033715	50
FBSR 2-8	3033808	10
FBS 2-6 BU	3036932	50
FBS 2-6 GY	3032237	50
FBS 2-8	3030284	10
FBS 2-8 BU	3032567	10
FBS 2-8 GY	3032541	10
CLIPFIX 35	3022218	50
MPS-MT	0201744	10
MPS-IH RD	0201676	10
MPS-IH WH	0201663	10
MPS-IH BU	0201689	10
MPS-IH YE	0201692	10
MPS-IH GN	0201702	10
MPS-IH GY	0201728	10
MPS-IH BK	0201731	10
ZB 5 :UNBEDRUCKT	1050004	10
ZB 15:UNBEDRUCKT	0811972	10
STP 5-2	0800967	100

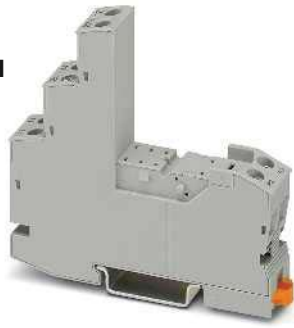

2-changeover-contact relay base with screw connection technology



Plastic relay retaining bracket for RIF-1 base



Metal wire relay retaining bracket for RIF-1 base



Technical data
250 V AC/DC
Max. 15.5 A (depends on application/assembly)
-40°C ... 85°C (depends on application/assembly)
0.5 ... 4 mm ² / 0.5 ... 4 mm ² / 20 - 10
16 mm
75 mm
89 mm

Technical data
-
-
-
-
-
-
-

Technical data
-
-
-
-
-
-
-

Ordering data		
Type	Order No.	Pcs./Pkt.
RIF-1-BSC/2X21	2900930	10

Ordering data		
Type	Order No.	Pcs./Pkt.
RIF-RH-1	2900953	10
RIF-RH-1-H	2904468	10

Ordering data		
Type	Order No.	Pcs./Pkt.
RIF-RHM-1	2905986	10
RIF-RHM-1-H	2905985	10

Accessories		
Type	Order No.	Pcs./Pkt.
FBS 2-6	3030336	50
FBSR 2-6	3033715	50
FBSR 2-8	3033808	10
FBS 2-6 BU	3036932	50
FBS 2-6 GY	3032237	50
FBS 2-8	3030284	10
FBS 2-8 BU	3032567	10
FBS 2-8 GY	3032541	10
	7042	
CLIPFIX 35	3022218	50
MPS-MT	0201744	10
MPS-IH RD	0201676	10
MPS-IH WH	0201663	10
MPS-IH BU	0201689	10
MPS-IH YE	0201692	10
MPS-IH GN	0201702	10
MPS-IH GY	0201728	10
MPS-IH BK	0201731	10
ZB 5 :UNBEDRUCKT	1050004	10
ZB 15:UNBEDRUCKT	0811972	10
STP 5-2	0800967	100

Accessories		
Type	Order No.	Pcs./Pkt.

Accessories		
Type	Order No.	Pcs./Pkt.

Plug-in miniature power relays

Plug-in miniature power relays with 1 or 2 changeover contacts, suitable for the RIF-1 and PLC-INTERFACE relay bases.

The advantages:

- Power contacts up to 16 A
- Multi-layer gold contact or power contact
- High degree of protection up to RT III depending on type (wash-proof)

Notes:
Notes:
If the specified maximum values for multi-layer contact relays are exceeded, the gold plating is destroyed. The maximum values of the power contact relay are then valid. This can result in a shorter service life than with a pure power contact.
When mounting relays on a DIN rail base or PCB, data may be limited, especially with regard to the limiting continuous current and/or ambient temperature range. See "General" section in "Fundamentals of relay technology" on page 272



Relay with one changeover contact, 16 A, maximum



Relay with two changeover contacts, 2 x 8 A, maximum

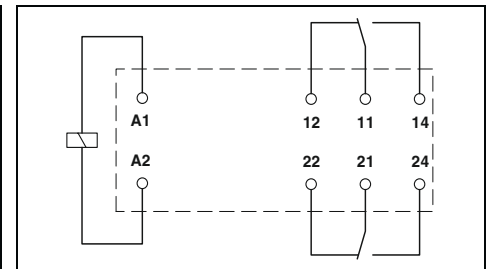
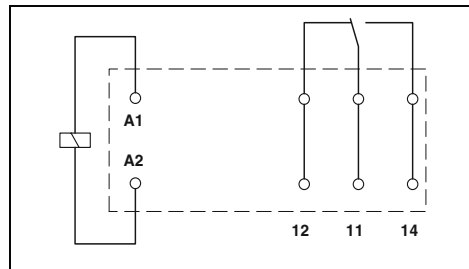

Input data		①	②	③	④	⑤	⑥	⑦	⑧
Permissible range (with reference to U_N)		See diagram							
Typical input current at U_N	[mA]	33	17	8.7	8.2	4.1	32	7	3
Typical response time at U_N	[ms]	7	7	7	7	7			
Typical response time at U_N (depending on phase relation)	[ms]						3-12	3-12	3-12
Typical release time at U_N	[ms]	3	3	3	3	3			
Typical release time at U_N (depending on phase relation)	[ms]						2-9	2-9	2-9
Output data									
Contact type		1 PDT			1 PDT			2 PDT	
Contact material		AgNi			AgNi, hard gold-plated			AgNi, hard gold-plated	
Max. switching voltage		250 V AC/DC			30 V AC / 36 V DC			250 V AC/DC	
Minimum switching voltage		12 V (at 10 mA)			100 mV (at 10 mA)			5 V (at 10 mA)	
Limiting continuous current		16 A			50 mA			8 A	
Maximum switch-on current AC		25 A (20 ms)			50 mA			12 A (20 ms)	
Maximum switch-on current DC		50 A (20 ms)			50 mA			25 A (20 ms)	
Minimum switching current		10 mA (at 12 V)			1 mA (at 24 V)			10 mA (at 5 V)	
General data									
Test voltage (winding/contact)		5 kV AC (50 Hz, 1 min.)							
Test voltage (contact / contact)		-							
Ambient temperature (operation), AC		-40°C ... 85°C							
Ambient temperature (operation), DC		-40°C ... 85°C							
Mechanical service life, AC		1x 10 ⁷ cycles							
Mechanical service life, DC		3x 10 ⁷ cycles							
Standards/regulations		IEC 60664, EN 50178, EN 61810-1							

Technical data								
①	②	③	④	⑤	⑥	⑦	⑧	⑨
See diagram								
33	17	8.7	8.2	4.1	32	7	3	
7	7	7	7	7				
					3-12	3-12	3-12	
3	3	3	3	3				
					2-9	2-9	2-9	
1 PDT			1 PDT			2 PDT		
AgNi			AgNi, hard gold-plated			AgNi, hard gold-plated		
250 V AC/DC			30 V AC / 36 V DC			250 V AC/DC		
12 V (at 10 mA)			100 mV (at 10 mA)			5 V (at 10 mA)		
16 A			50 mA			8 A		
25 A (20 ms)			50 mA			12 A (20 ms)		
50 A (20 ms)			50 mA			25 A (20 ms)		
10 mA (at 12 V)			1 mA (at 24 V)			10 mA (at 5 V)		
5 kV AC (50 Hz, 1 min.)								
-								
-40°C ... 85°C								
-40°C ... 85°C								
1x 10 ⁷ cycles								
3x 10 ⁷ cycles								
IEC 60664, EN 50178, EN 61810-1								

Technical data								
①	②	③	④	⑤	⑥	⑦	⑧	⑨
See diagram								
33	17	8.7	8.2	4.1	32	7	3	
7	7	7	7	7				
					3-12	3-12	3-12	
3	3	3	3	3				
					2-9	2-9	2-9	
2 PDT			2 PDT			2 PDT		
AgNi			AgNi, hard gold-plated			AgNi, hard gold-plated		
250 V AC/DC			30 V AC / 36 V DC			250 V AC/DC		
5 V (at 10 mA)			100 mV (at 10 mA)			100 mV (at 10 mA)		
8 A			50 mA			8 A		
12 A (20 ms)			50 mA			12 A (20 ms)		
25 A (20 ms)			50 mA			25 A (20 ms)		
10 mA (at 5 V)			1 mA (at 24 V)			10 mA (at 5 V)		
5 kV AC (50 Hz, 1 min.)								
2.5 kV AC (50 Hz, 1 min.)								
-40°C ... 85°C								
-40°C ... 85°C								
1x 10 ⁷ cycles								
3x 10 ⁷ cycles								
IEC 60664, EN 50178, EN 61810-1								

Description	Input voltage U_N
Plug-in miniature power relays, with power contacts	
①	12 V DC
②	24 V DC
③	48 V DC
④	60 V DC
⑤	110 V DC
⑥	24 V AC
⑦	120 V AC
⑧	230 V AC
Plug-in miniature power relays, with multi-layer gold contacts	
①	12 V DC
②	24 V DC
③	48 V DC
④	60 V DC
⑤	110 V DC
⑥	24 V AC
⑦	120 V AC
⑧	230 V AC

Ordering data		
Type	Order No.	Pcs./Pkt.
REL-MR- 12DC/21HC	2961309	10
REL-MR- 24DC/21HC	2961312	10
REL-MR- 48DC/21HC	2834821	10
REL-MR- 60DC/21HC	2961325	10
REL-MR-110DC/21HC	2961338	10
REL-MR- 24AC/21HC	2961406	10
REL-MR-120AC/21HC	2961419	10
REL-MR-230AC/21HC	2961422	10
REL-MR- 12DC/21HC AU	2961532	10
REL-MR- 24DC/21HC AU	2961545	10
REL-MR-110DC/21HC AU	2961561	10
REL-MR- 24AC/21HC AU	2961503	10
REL-MR-120AC/21HC AU	2961516	10
REL-MR-230AC/21HC AU	2961529	10

Ordering data		
Type	Order No.	Pcs./Pkt.
REL-MR- 12DC/21-21	2961257	10
REL-MR- 24DC/21-21	2961192	10
REL-MR- 48DC/21-21	2834834	10
REL-MR- 60DC/21-21	2961273	10
REL-MR-110DC/21-21	2961202	10
REL-MR- 24AC/21-21	2961435	10
REL-MR-120AC/21-21	2961448	10
REL-MR-230AC/21-21	2961451	10
REL-MR- 12DC/21-21AU	2961299	10
REL-MR- 24DC/21-21AU	2961215	10
REL-MR- 48DC/21-21AU	2834847	10
REL-MR- 60DC/21-21AU	2961286	10
REL-MR-110DC/21-21AU	2961228	10
REL-MR- 24AC/21-21AU	2961464	10
REL-MR-120AC/21-21AU	2961477	10
REL-MR-230AC/21-21AU	2961480	10

REL-MR...21HC... (1 changeover contact)

Operating voltage range

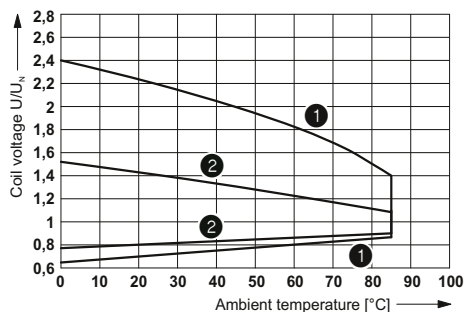

- 1 DC coils
- 2 AC coils

Interrupting rating

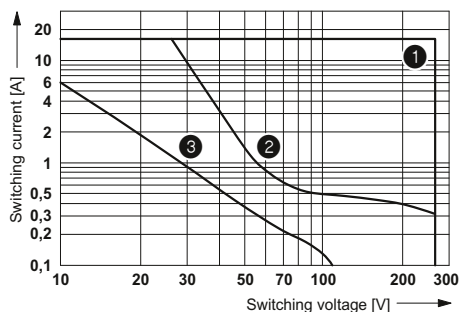

- 1 AC, ohmic load
- 2 DC, ohmic load
- 3 DC, L/R = 40 ms

Electrical service life

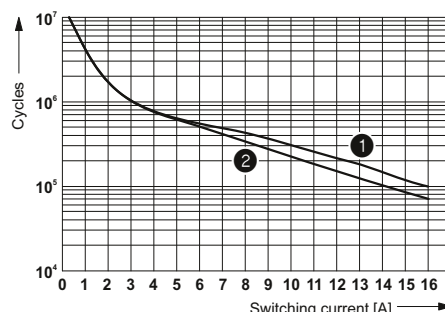

- 1 250 V AC, ohmic load (DC coils)
- 2 250 V AC, ohmic load (AC coils)

Service life reduction factor with various cos phi

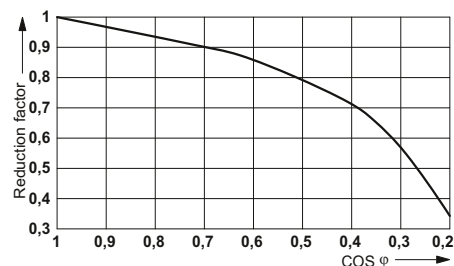

REL-MR...21-21... (2 changeover contacts)

Operating voltage range

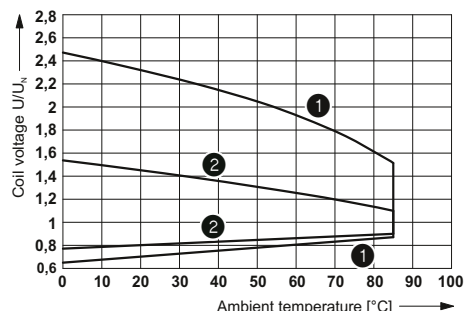

- 1 DC coils
- 2 AC coils

Interrupting rating

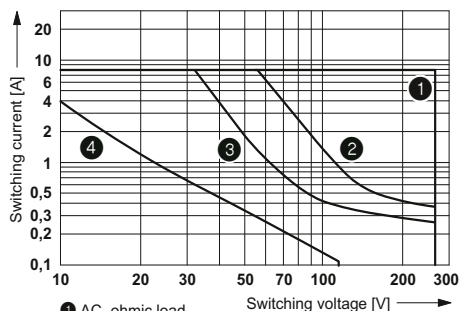

- 1 AC, ohmic load
- 2 DC, ohmic load
- 3 DC, ohmic load, contacts in series
- 4 DC, L/R = 40 ms

Electrical service life

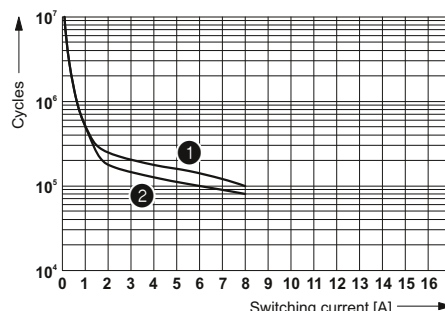

- 1 250 V AC, ohmic load (DC coils)
- 2 250 V AC, ohmic load (AC coils)

Service life reduction factor with various cos phi

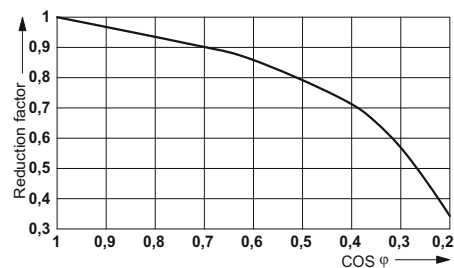

Plug-in miniature power relays

Plug-in miniature power relays with 1 or 2 changeover contacts, compatible for the RIF-1 relay base.

The advantages:

- Switching current of up to 16 A
- With lockable manual operation
- Mechanical switch position indicator
- Integrated status LED
- Multi-layer gold contact or power contact
- DC types with integrated free-wheeling diode
- Can be soldered in on PCB



Relay with one changeover contact with manual operation, 16 A, maximum



Relay with two changeover contacts with manual operation, 2 x 8 A, maximum

Notes:

If the specified maximum values for multi-layer contact relays are exceeded, the gold plating is destroyed. The maximum values of the power contact relay are then valid. This can result in a shorter service life than with a pure power contact.

When mounting relays on a DIN rail base or PCB, data may be limited, especially with regard to the limiting continuous current and/or ambient temperature range. See "General" section in "Fundamentals of relay technology" on page 272

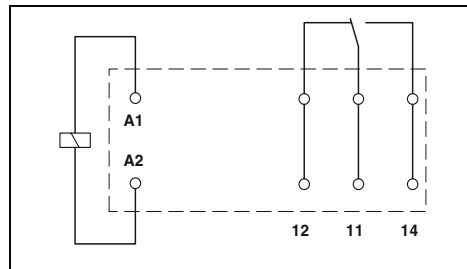

Technical data

Input data	①	②	③	④
Permissible range (with reference to U_N)	See diagram			
Typical input current at U_N [mA]	18	32	7	3.5
Typical response time at U_N [ms]	9			
Typical response time at U_N (depending on phase relation) [ms]		3 - 12	3 - 12	
Typical release time at U_N [ms]	6			
Typical release time at U_N (depending on phase relation) [ms]		2 - 8	2 - 8	2 - 8
Output data				
Contact type	1 PDT		1 PDT	
Contact material	AgNi		AgNi, hard gold-plated	
Max. switching voltage	250 V AC/DC		30 V AC / 36 V DC	
Minimum switching voltage	12 V (at 10 mA)		12 V (at 1 mA)	
Limiting continuous current	16 A		50 mA	
Maximum switch-on current AC	32 A (20 ms)		50 mA	
Maximum switch-on current DC	32 A (20 ms)		50 mA	
Minimum switching current	10 mA (at 12 V)		1 mA (at 12 V)	
General data				
Test voltage (winding/contact)	5 kV AC (50 Hz, 1 min.)			
Test voltage (contact / contact)	-			
Ambient temperature (operation), AC	-40°C ... 70°C			
Ambient temperature (operation), DC	-40°C ... 70°C			
Mechanical service life, AC	5x 10 ⁶ cycles			
Mechanical service life, DC	5x 10 ⁶ cycles			
Standards/regulations	EN 61810-1, VDE 0435-201, EN 50178			

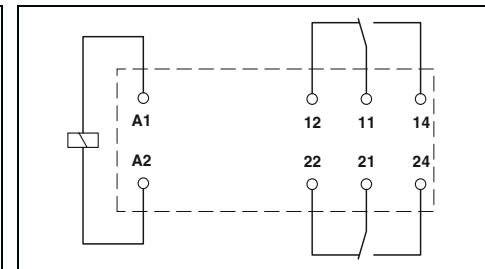

Technical data

Input data	①	②	③	④
Permissible range (with reference to U_N)	See diagram			
Typical input current at U_N [mA]	18	32	7	3.5
Typical response time at U_N [ms]	9			
Typical response time at U_N (depending on phase relation) [ms]		3 - 12	3 - 12	3 - 12
Typical release time at U_N [ms]	6			
Typical release time at U_N (depending on phase relation) [ms]		2 - 8	2 - 8	2 - 8
Output data				
Contact type	2 PDT		2 PDT	
Contact material	AgNi		AgNi, hard gold-plated	
Max. switching voltage	250 V AC/DC		30 V AC / 36 V DC	
Minimum switching voltage	12 V (at 10 mA)		12 V (at 1 mA)	
Limiting continuous current	8 A		50 mA	
Maximum switch-on current AC	16 A (20 ms)		50 mA	
Maximum switch-on current DC	16 A (20 ms)		50 mA	
Minimum switching current	10 mA (at 12 V)		1 mA (at 12 V)	
General data				
Test voltage (winding/contact)	5 kV AC (50 Hz, 1 min.)			
Test voltage (contact / contact)	-			
Ambient temperature (operation), AC	-40°C ... 70°C			
Ambient temperature (operation), DC	-40°C ... 70°C			
Mechanical service life, AC	5x 10 ⁶ cycles			
Mechanical service life, DC	5x 10 ⁶ cycles			
Standards/regulations	EN 61810-1, VDE 0435-201, EN 50178			

Ordering data

Description	Input voltage U_N
Plug-in miniature power relays, with power contacts	
- Status LED, freewheeling diode A1+, A2-	① 24 V DC
- Status LED	② 24 V AC
- Status LED	③ 120 V AC
- Status LED	④ 230 V AC
Plug-in miniature power relays, with multi-layer gold contacts, with manual operation, mechanical switch position indicator	
- Status LED, freewheeling diode A1+, A2-	① 24 V DC
- Status LED	⑤ 230 V AC

Type	Order No.	Pcs./Pkt.
REL-MR- 24DC/21HC/MS	2987888	10
REL-MR- 24AC/21HC/MS	2987891	10
REL-MR-120AC/21HC/MS	2987901	10
REL-MR-230AC/21HC/MS	2987914	10
REL-MR- 24DC/21HC AU/MS	2987927	10
REL-MR-230AC/21HC AU/MS	2987930	10

Ordering data

Type	Order No.	Pcs./Pkt.
REL-MR- 24DC/21-21/MS	2987943	10
REL-MR- 24AC/21-21/MS	2987956	10
REL-MR-120AC/21-21/MS	2987969	10
REL-MR-230AC/21-21/MS	2987972	10
REL-MR- 24DC/21-21AU/MS	2987985	10
REL-MR-230AC/21-21AU/MS	2987998	10

REL-MR...21HC...MS (1 changeover contact)

Operating voltage range

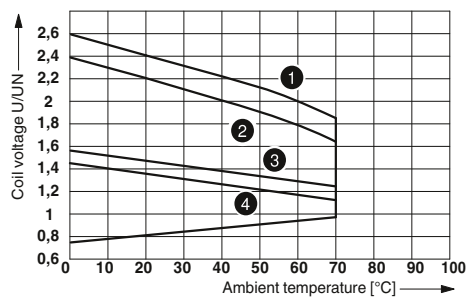

- 1 DC coils, 0 A contact current
- 2 DC coils, 16 A contact current
- 3 AC coils, 0 A contact current
- 4 AC coils, 16 A contact current

Interrupting rating

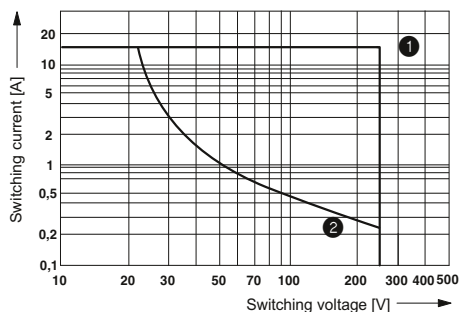

- 1 AC, ohmic load
- 2 DC, ohmic load

Electrical service life

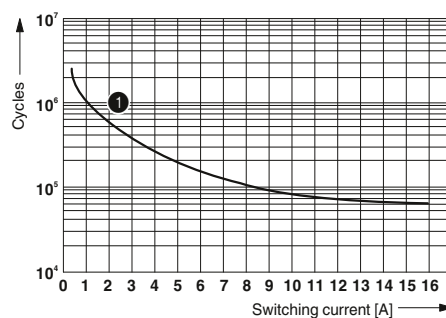

- 1 250 V AC, ohmic load

Service life reduction factor with various cos phi

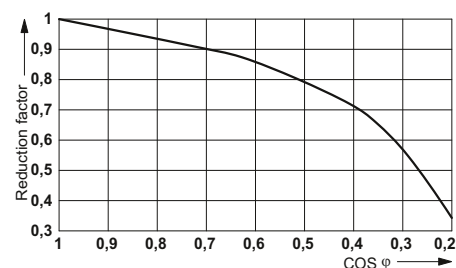

REL-MR...21-21...MS (2 changeover contacts)

Operating voltage range

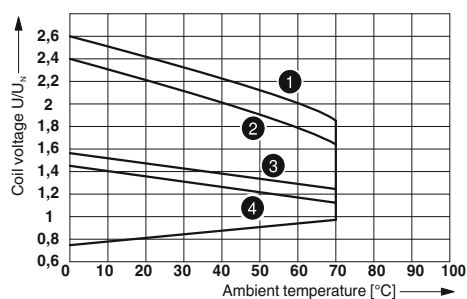

- 1 DC coils, 0 A contact current
- 2 DC coils, 8 A contact current
- 3 AC coils, 0 A contact current
- 4 AC coils, 8 A contact current

Interrupting rating

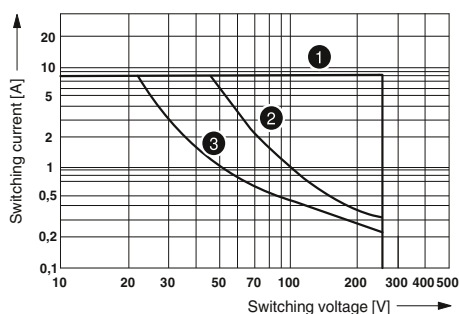

- 1 AC, ohmic load
- 2 DC, ohmic load, contacts in series
- 3 DC, ohmic load

Electrical service life

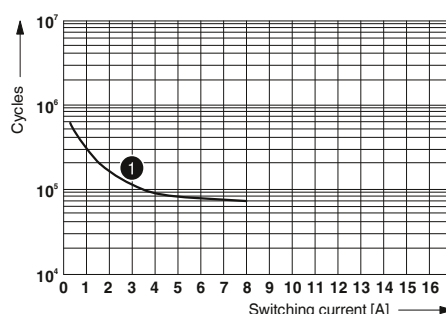

- 1 250 V AC, ohmic load

Service life reduction factor with various cos phi

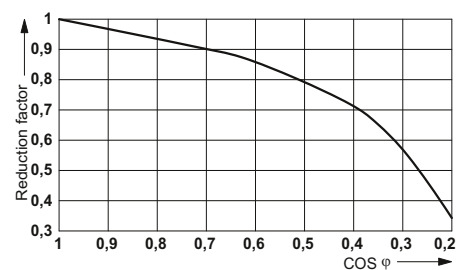

Non-polarized plug-in miniature power relays

Non-polarized plug-in miniature power relays with 1 or 2 changeover contacts, compatible with the RIF-1 relay base.

The advantages:

- Switching current of up to 16 A
- With lockable manual operation
- Mechanical switch position indicator
- Multi-layer power contact
- Can be soldered in on PCB
- Special voltages (100 and 200 V AC)

Notes:

When mounting relays on a DIN rail base or PCB, data may be limited, especially with regard to the limiting continuous current and/or ambient temperature range. See "General" section in "Fundamentals of relay technology" on page 272



Relay with one changeover contact (non-polarized) with manual operation, 16 A, maximum



Relay with two changeover contacts (non-polarized) with manual operation, 2 x 8 A, maximum

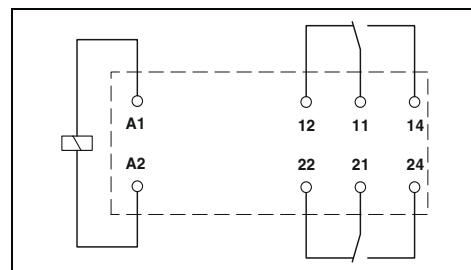
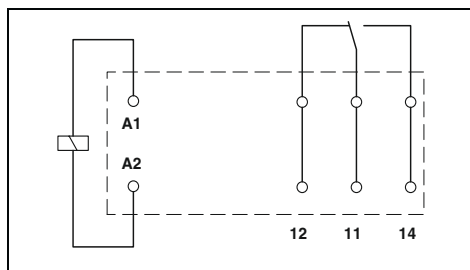

Technical data

Input data	①	②	③
Permissible range (with reference to U_N)	See diagram		
Typical input current at U_N	17	8	4
Typical response time at U_N	9		
Typical response time at U_N (depending on phase relation)		3 - 12	3 - 12
Typical release time at U_N	6		
Typical release time at U_N (depending on phase relation)		2 - 8	2 - 8
Output data			
Contact type	1 PDT		
Contact material	AgNi		
Max. switching voltage	250 V AC/DC		
Minimum switching voltage	12 V (at 10 mA)		
Limiting continuous current	16 A		
Maximum switch-on current AC	32 A (20 ms)		
Maximum switch-on current DC	32 A (20 ms)		
Minimum switching current	10 mA (at 12 V)		
General data			
Test voltage (winding/contact)	5 kV AC (50 Hz, 1 min.)		
Ambient temperature (operation), AC	-40°C ... 70°C		
Ambient temperature (operation), DC	-40°C ... 70°C		
Mechanical service life, AC	5x 10 ⁶ cycles		
Mechanical service life, DC	5x 10 ⁶ cycles		
Standards/regulations	IEC 61810, IEC 60664		

Ordering data

Description	Input voltage U_N
Non-polarized plug-in miniature power relays, with power contacts	① 24 V DC
	② 100 V AC
	③ 200 V AC

Type	Order No.	Pcs./Pkt.
REL-MR-BL-24DC/21HC/MS	2908180	10
REL-MR-BL-100AC/21HC/MS	2908179	10
REL-MR-BL-200AC/21HC/MS	2908178	10

Technical data

Input data	①	②	③
Permissible range (with reference to U_N)	See diagram		
Typical input current at U_N	17	8	4
Typical response time at U_N	9		
Typical response time at U_N (depending on phase relation)		3 - 12	3 - 12
Typical release time at U_N	6		
Typical release time at U_N (depending on phase relation)		2 - 8	2 - 8
Output data			
Contact type	2 PDT		
Contact material	AgNi		
Max. switching voltage	250 V AC/DC		
Minimum switching voltage	12 V (at 10 mA)		
Limiting continuous current	8 A		
Maximum switch-on current AC	16 A (20 ms)		
Maximum switch-on current DC	16 A (20 ms)		
Minimum switching current	10 mA (at 12 V)		
General data			
Test voltage (winding/contact)	5 kV AC (50 Hz, 1 min.)		
Ambient temperature (operation), AC	-40°C ... 70°C		
Ambient temperature (operation), DC	-40°C ... 70°C		
Mechanical service life, AC	5x 10 ⁶ cycles		
Mechanical service life, DC	5x 10 ⁶ cycles		
Standards/regulations	IEC 61810, IEC 60664		

Ordering data

Type	Order No.	Pcs./Pkt.
REL-MR-BL-24DC/21-21/MS	2908181	10
REL-MR-BL-100AC/21-21/MS	2908183	10
REL-MR-BL-200AC/21-21/MS	2908182	10

REL-MR-BL...21HC/MS (1 changeover contact)

Operating voltage range

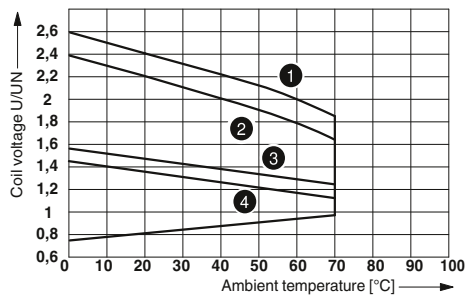

- 1 DC coils, 0 A contact current
- 2 DC coils, 16 A contact current
- 3 AC coils, 0 A contact current
- 4 AC coils, 16 A contact current

Interrupting rating

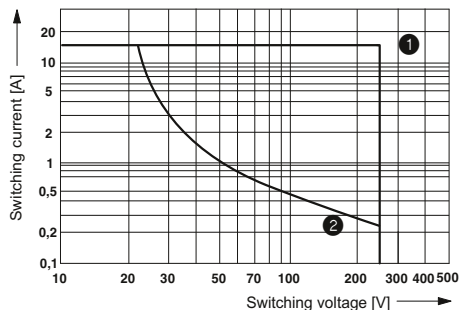

- 1 AC, ohmic load
- 2 DC, ohmic load

Electrical service life

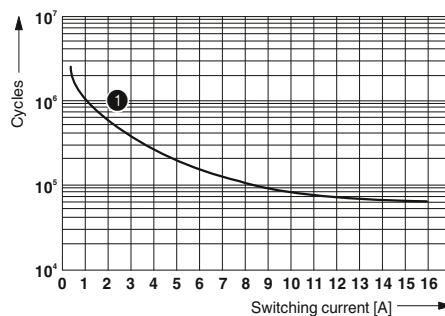

- 1 250 V AC, ohmic load

Service life reduction factor with various cos phi

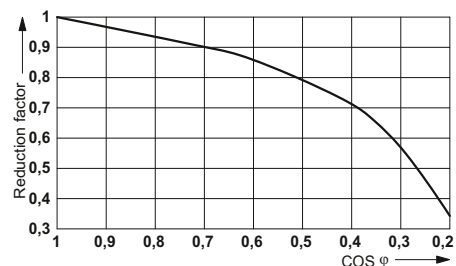

REL-MR-BL...21-21/MS (2 changeover contacts)

Operating voltage range

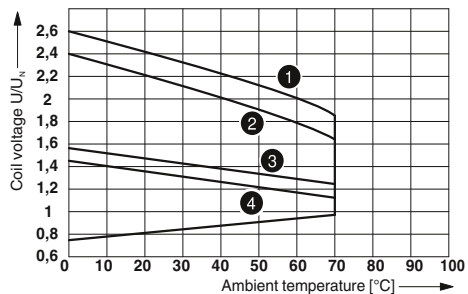

- 1 DC coils, 0 A contact current
- 2 DC coils, 8 A contact current
- 3 AC coils, 0 A contact current
- 4 AC coils, 8 A contact current

Interrupting rating

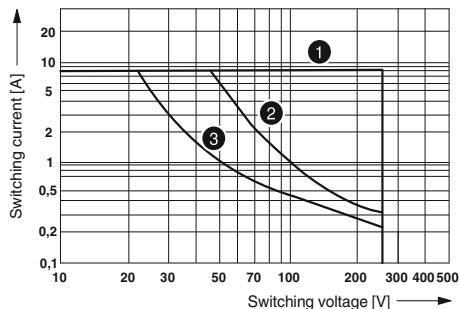

- 1 AC, ohmic load
- 2 DC, ohmic load, contacts in series
- 3 DC, ohmic load

Electrical service life

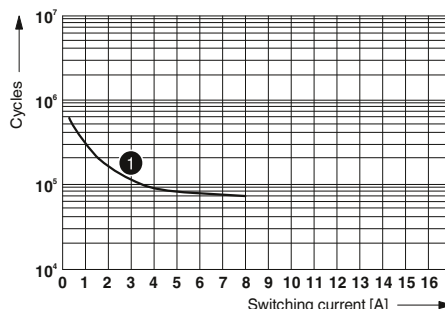

- 1 250 V AC, ohmic load

Service life reduction factor with various cos phi

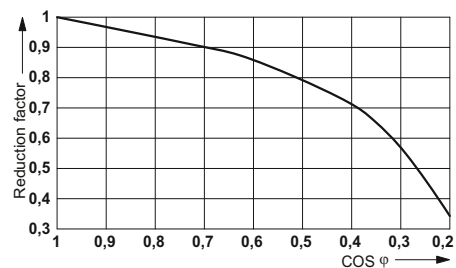

Plug-in solid-state relays

Plug-in solid-state relays are compatible for both relay bases RIF-1 and PLC-INTERFACE.

The advantages:

- Switching current of up to 5 A
- RT III seal (wash-proof)
- Vibration- and shock-resistant
- Wear-free and long-lasting
- Zero voltage switch at AC output
- Can be soldered in on PCB

Notes:

For dimensional drawings and perforations for assembly, see page 401

When mounting relays on a DIN rail base or PCB, data may be limited, especially with regard to the limiting continuous current and/or ambient temperature range. See "General" section in "Fundamentals of relay technology" on page 272



Solid-state relay,
DC output max. 5 A

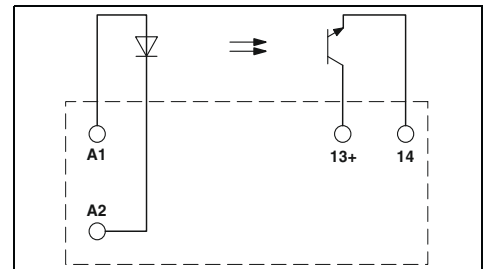

Technical data

	①	②	③
Input data			
Permissible range (with reference to U_N)	0.8 - 1.2	0.8 - 1.2	0.9 - 1.1
Switching level	1 signal ("H") [V DC] \geq 0 signal ("L") [V DC] \leq	2.5 0.8	16 10 20
Typical input current at U_N		9	7 3
Typical switch-on time at U_N		10	20 25
Typical switch-off time at U_N		400	400 400
Transmission frequency f_{limit}		300	300 300
Output data			
Max. switching voltage		33 V DC	
Minimum switching voltage		3 V DC	
Limiting continuous current		5 A (see derating curve)	
Minimum load current		-	
Maximum switch-on current		15 A (10 ms)	
Leakage current in off state		-	
Output circuit		2-conductor, floating	
Max. load value		-	
Output protection		Reverse polarity protection, surge protection	
Voltage drop at maximum limiting continuous current		≤ 200 mV	
General data			
Rated surge voltage		Basic insulation	
Test voltage input/output		2.5 kV (50 Hz, 1 min.)	
Ambient temperature (operation)		-25°C ... 60°C	
Nominal operating mode		100% operating factor	
Standards/regulations		IEC 60664, EN 50178	
Degree of pollution/surge voltage category		2 / III	
Mounting position/mounting		Any / in rows with zero spacing	
Dimensions	W / H / D	12.7 mm / 29 mm / 15.7 mm	

Ordering data

Description	Input voltage U_N	Type	Order No.	Pcs./Pkt.
Plug-in solid-state relays				
Solid-state power relays	① 5 V DC	OPT-5DC/ 24DC/ 5	2982113	10
Solid-state power relays	② 24 V DC	OPT-24DC/ 24DC/ 5	2982100	10
Solid-state power relays	③ 60 V DC	OPT-60DC/ 24DC/ 5	2982126	10



**Solid-state relay,
AC output max. 2 A**

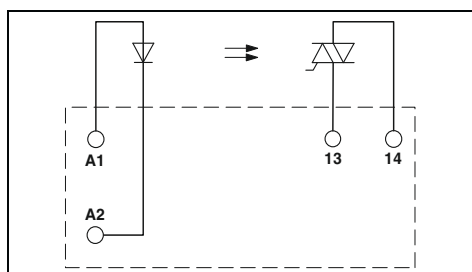

Technical data

①	②
0.8 -	0.8 -
1.2	1.2
3	18
1	8,4
15	7
10,000	10,000
10,000	10,000
10	10

253 V AC
24 V AC
2 A (see derating curve)
25 mA
30 A (10 ms)
<1 mA
2-conductor floating, zero voltage switch
4 A²s (tp = 10 ms, at 25°C)
Surge protection
≤1 V

Basic insulation
2.5 kV (50 Hz, 1 min.)
-25°C ... 60°C
100% operating factor
IEC 60664, EN 50178
2 / III
Any / see derating curve
12.7 mm / 29 mm / 15.7 mm

Ordering data

Type	Order No.	Pcs./Pkt.
OPT-5DC/230AC/ 2	2982168	10
OPT-24DC/230AC/ 2	2982171	10

Derating curve for OPT...DC/24DC/5 solid-state relays

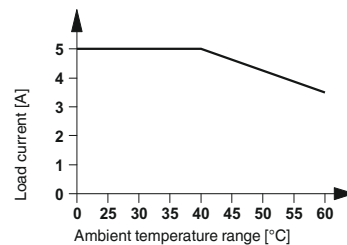

Derating curve for OPT...DC/230AC/2 solid-state relays

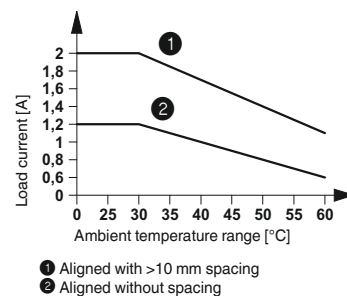

RIFLINE complete – Industrial relay system

Modular RIF-2 relay bases

Relay bases for assembly with 2 or 4-changeover-contact industrial relay.

Range of accessories includes:

- Plug-in interference suppression module
- Plug-in timer module
- Relay retaining bracket with ejector function and holder for marking material
- Comprehensive range of marking material
- Test plug
- FBS 2-6 plug-in bridges for the input side (A2)

Notes:
Type of insulating housing: Polyamide PA non-reinforced, color: gray.
For further marking systems and mounting material, see Catalog 3.
When mounting relays on a DIN rail base or PCB, data may be limited, especially with regard to the limiting continuous current and/or ambient temperature range. See "General" section in "Fundamentals of relay technology" on page 272



4-changeover-contact relay base with Push-in connection technology for industrial relays



Nominal voltage U_N
Nominal current at U_N

General data
Ambient temperature (operation)
Connection data solid/stranded/AWG
Dimensions
Width
Depth with retaining bracket
Height

Technical data
250 V AC/DC Max. 12 A (depends on application/assembly)
-40°C ... 85°C (depends on application/assembly)
0.14 ... 1.5 mm ² / 0.14 ... 1.5 mm ² / 26 - 16
31 mm
75 mm
96 mm

Description
RIF-2 relay base , plug-in option for interference suppression module, safe isolation I/O with Push-in connection
RIF-2 relay base , plug-in option for interference suppression module, safe isolation I/O with screw connection
Plastic relay retaining bracket , with ejector function and holder for marking material, suitable for RIF-2 relay base
Reinforced plastic relay retaining bracket , with ejector function and holder for marking material, compatible for RIF-2 relay base
Relay retaining bracket , wire model, suitable for RIF-2 relay base

Ordering data		
Type	Order No.	Pcs./Pkt.
RIF-2-BPT/4X21	2900934	10

Plug-in bridge 2-pos. red, 32 A 2-pos. red, 24 A 2-pos. blue, 32 A 2-pos. gray, 32 A
End clamp , to snap on NS 35, 9.5 mm wide, can be labeled with ZB 6, ZB 8/27, KLM...
Test plug , consisting of: Metal part for 2.3 mm Ø socket hole and gray
Insulating sleeve , for MPS metal part red white blue yellow green gray black
Zack marker strip, unprinted 10-section 5-section
Double marker carrier for ZB 5

Accessories		
Type	Order No.	Pcs./Pkt.
FBS 2-6	3030336	50
FBSR 2-6	3033715	50
FBS 2-6 BU	3036932	50
FBS 2-6 GY	3032237	50
CLIPFIX 35	3022218	50
MPS-MT	0201744	10
MPS-IH RD	0201676	10
MPS-IH WH	0201663	10
MPS-IH BU	0201689	10
MPS-IH YE	0201692	10
MPS-IH GN	0201702	10
MPS-IH GY	0201728	10
MPS-IH BK	0201731	10
ZB 5 :UNBEDRUCKT	1050004	10
ZB 15:UNBEDRUCKT	0811972	10
STP 5-2	0800967	100

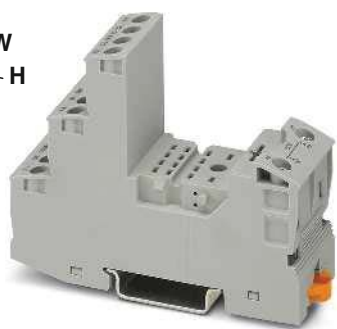

4-changeover-contact relay base with screw connection technology for industrial relays



Plastic relay retaining bracket for RIF-2 base



Metal wire relay retaining bracket for RIF-2 base



Technical data
250 V AC/DC
Max. 12 A (depends on application/assembly)
-40°C ... 85°C (depends on application/assembly)
0.5 ... 4 mm ² / 0.5 ... 4 mm ² / 20 - 10
27 mm
75 mm
89 mm

Technical data
-
-
-
-
-
-
-

Technical data
-
-
-
-
-
-
-

Ordering data		
Type	Order No.	Pcs./Pkt.
RIF-2-BSC/4X21	2900932	10

Ordering data		
Type	Order No.	Pcs./Pkt.
RIF-RH-2	2900954	10
RIF-RHS-2	2908043	10

Ordering data		
Type	Order No.	Pcs./Pkt.
RIF-RHM-2	2905984	10

Accessories		
Type	Order No.	Pcs./Pkt.
FBS 2-6	3030336	50
FBSR 2-6	3033715	50
FBS 2-6 BU	3036932	50
FBS 2-6 GY	3032237	50
CLIPFIX 35	3022218	50
MPS-MT	0201744	10
MPS-IH RD	0201676	10
MPS-IH WH	0201663	10
MPS-IH BU	0201689	10
MPS-IH YE	0201692	10
MPS-IH GN	0201702	10
MPS-IH GY	0201728	10
MPS-IH BK	0201731	10
ZB 5 :UNBEDRUCKT	1050004	10
ZB 15:UNBEDRUCKT	0811972	10
STP 5-2	0800967	100

Accessories		
Type	Order No.	Pcs./Pkt.

Accessories		
Type	Order No.	Pcs./Pkt.

Plug-in industrial relays

Plug-in industrial relays with 2 or 4 changeover contacts, compatible for RIF-2 relay base.

The advantages:

- With lockable manual operation
- Mechanical switch position indicator
- Integrated status LED
- Multi-layer gold contact or power contact
- DC types with integrated free-wheeling diode



Industrial relay with two changeover contacts with manual operation, 2 x 12 A, maximum



Industrial relay with four changeover contacts with manual operation, 4 x 6 A, maximum

Notes:	
For more voltages, see phoenixcontact.com/products	
When mounting relays on a DIN rail base or PCB, data may be limited, especially with regard to the limiting continuous current and/or ambient temperature range. See "General" section in "Fundamentals of relay technology" on page 272	
If the specified maximum values for multi-layer contact relays are exceeded, the gold plating is destroyed. The maximum values of the power contact relay are then valid. This can result in a shorter service life than with a pure power contact.	

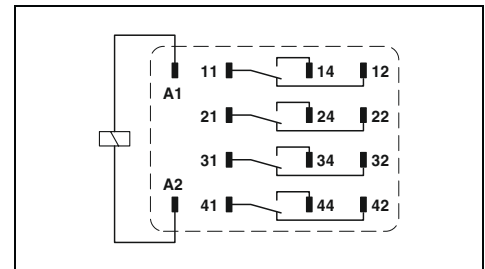
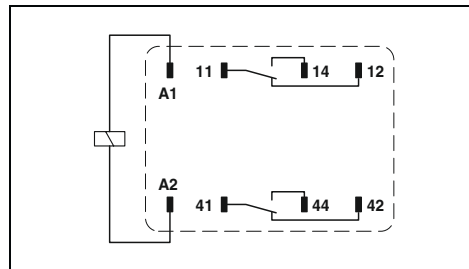

Input data	
Permissible range (with reference to U_N)	
Typical input current at U_N	[mA]
Typical response time at U_N	[ms]
Typical response time at U_N (depending on phase relation)	[ms]
Typical release time at U_N	[ms]
Typical release time at U_N (depending on phase relation)	[ms]
Output data	
Contact type	
Contact material	
Max. switching voltage	
Minimum switching voltage	
Limiting continuous current	
Maximum switch-on current AC	
Maximum switch-on current DC	
Minimum switching current	
General data	
Test voltage (winding/contact)	
Ambient temperature (operation), AC	
Ambient temperature (operation), DC	
Mechanical service life, AC	
Mechanical service life, DC	
Standards/regulations	

Technical data							
①	②	③	④	⑤	⑥	⑦	⑧
See diagram							
78	42	8	7.7	4	66	13	6.5
13	13	13	13	13			
					5 - 15	5 - 15	5 - 15
14	14	14	14	14			
					5 - 20	5 - 20	5 - 20
2 PDT							
AgNi							
250 V AC/DC							
5 V (at 24 mA)							
12 A							
30 A (20 ms, N/O contact)							
30 A (20 ms, N/O contact)							
5 mA (at 24 V)							
2.5 kV _{ms} (50 Hz, 1 min.)							
-40°C ... 55°C							
-40°C ... 70°C							
Approx. 2x 10 ⁷ cycles							
Approx. 2x 10 ⁷ cycles							
IEC 60664, IEC 61810							

Technical data							
①	②	③	④	⑤	⑥	⑦	⑧
See diagram							
78	42	8	7.7	4	66	13	6.5
13	13	13	13	13			
					5 - 15	5 - 15	5 - 15
14	14	14	14	14			
					5 - 20	5 - 20	5 - 20
4 PDTs							
AgNi							
250 V AC/DC							
5 V (at 24 mA)							
6 A							
16 A (20 ms, N/O contact)							
16 A (20 ms, N/O contact)							
5 mA (at 24 V)							
2.5 kV _{ms} (50 Hz, 1 min.)							
-40°C ... 55°C							
-40°C ... 70°C							
Approx. 2x 10 ⁷ cycles							
Approx. 2x 10 ⁷ cycles							
IEC 60664, IEC 61810							

Ordering data	
Description	Input voltage U_N
Plug-in industrial relays, with power contacts	
With freewheeling diode	① 12 V DC
With freewheeling diode	② 24 V DC
With freewheeling diode	③ 110 V DC
With freewheeling diode	④ 125 V DC
With freewheeling diode	⑤ 220 V DC
	⑥ 24 V AC
	⑦ 120 V AC
	⑧ 230 V AC
Plug-in industrial relays, with multi-layer gold contacts	
With freewheeling diode	① 12 V DC
With freewheeling diode	② 24 V DC
With freewheeling diode	③ 110 V DC
With freewheeling diode	④ 125 V DC
With freewheeling diode	⑤ 220 V DC
	⑥ 24 V AC
	⑦ 120 V AC
	⑧ 230 V AC

Type	Order No.	Pcs./Pkt.
REL-IR2/LDP- 12DC/2X21	2903659	10
REL-IR2/LDP- 24DC/2X21	2903660	10
REL-IR2/LDP-110DC/2X21	2903663	10
REL-IR2/LDP-125DC/2X21	2903664	10
REL-IR2/LDP-220DC/2X21	2903665	10
REL-IR2/L- 24AC/2X21	2903666	10
REL-IR2/L-120AC/2X21	2903667	10
REL-IR2/L-230AC/2X21	2903668	10

Ordering data		
Type	Order No.	Pcs./Pkt.
REL-IR4/LDP- 12DC/4X21	2903676	10
REL-IR4/LDP- 24DC/4X21	2903677	10
REL-IR4/LDP-110DC/4X21	2903680	10
REL-IR4/LDP-125DC/4X21	2903681	10
REL-IR4/LDP-220DC/4X21	2903682	10
REL-IR4/L- 24AC/4X21	2903686	10
REL-IR4/L-120AC/4X21	2903687	10
REL-IR4/L-230AC/4X21	2903688	10
REL-IR4/LDP- 12DC/4X21AU	2903669	10
REL-IR4/LDP- 24DC/4X21AU	2903670	10
REL-IR4/LDP-110DC/4X21AU	2903673	10
REL-IR4/LDP-125DC/4X21AU	2903674	10
REL-IR4/LDP-220DC/4X21AU	2903675	10
REL-IR4/L- 24AC/4X21AU	2903683	10
REL-IR4/L-120AC/4X21AU	2903684	10
REL-IR4/L-230AC/4X21AU	2903685	10

REL-IR2... (2 changeover contacts)

Operating voltage range

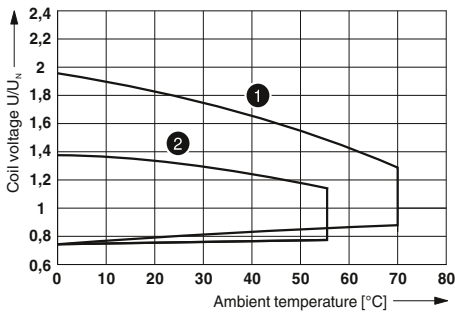

- ① DC coils
- ② AC coils

Interrupting rating

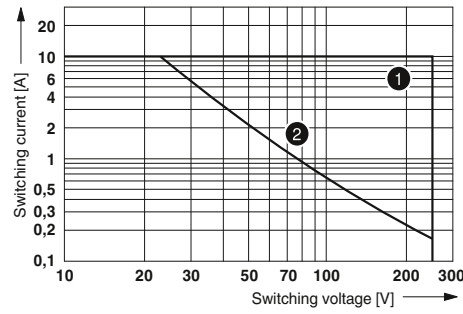

- ① AC, ohmic load
- ② DC, ohmic load

Electrical service life

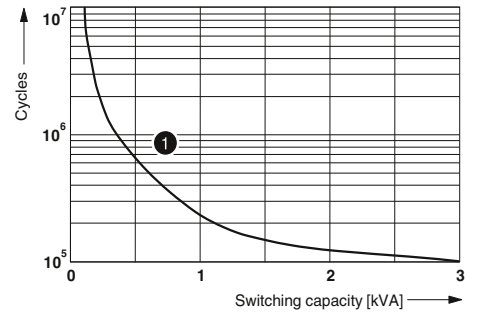

- ① 250 V AC, ohmic load

Service life reduction factor

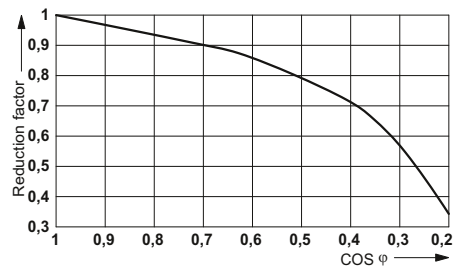

REL-IR4... (4 changeover contacts)

Operating voltage range

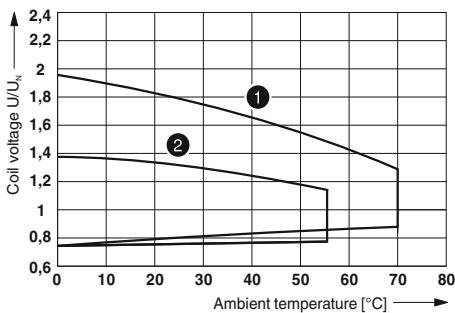

- ① DC coils
- ② AC coils

Interrupting rating

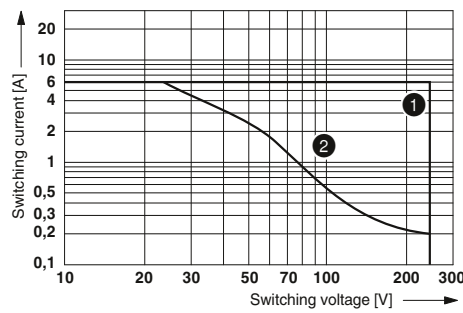

- ① AC, ohmic load
- ② DC, ohmic load

Electrical service life

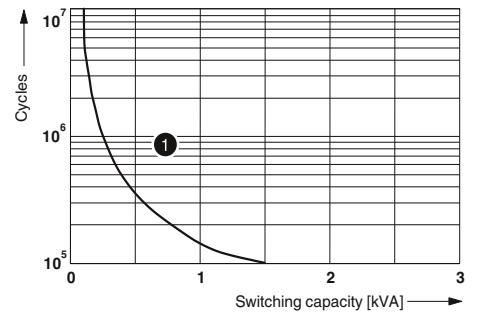

- ① 250 V AC, ohmic load

Service life reduction factor

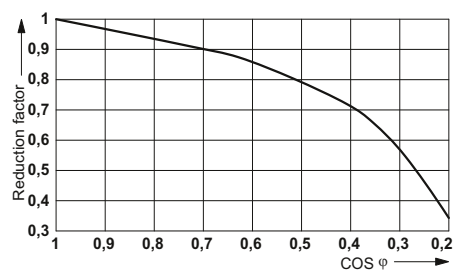

Non-polarized plug-in industrial relays

Non-polarized plug-in industrial relays with 2 or 4 changeover contacts, compatible with RIF-2 relay base.

The advantages:

- Switching current of up to 12 A
- With lockable manual operation
- Mechanical switch position indicator
- Special voltages (100 and 200 V AC)

Notes:

When mounting relays on a DIN rail base or PCB, data may be limited, especially with regard to the limiting continuous current and/or ambient temperature range. See "General" section in "Fundamentals of relay technology" on page 272



Industrial relay with two changeover contacts (non-polarized) with manual operation, 2 x 12 A, maximum



Industrial relay with four changeover contacts (non-polarized) with manual operation, 4 x 6 A, maximum

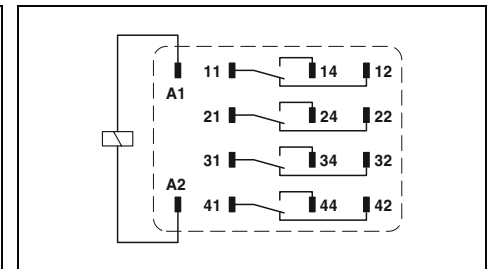
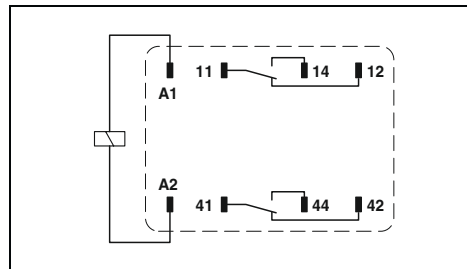

Technical data

Input data	①	②	③
Permissible range (with reference to U_N)	See diagram		
Typical input current at U_N [mA]	38	14.8	7.1
Typical response time at U_N [ms]	13		
Typical response time at U_N (depending on phase relation) [ms]		5 - 15	5 - 15
Typical release time at U_N [ms]	3		
Typical release time at U_N (depending on phase relation) [ms]		5 - 20	5 - 20
Output data			
Contact type	2 PDT		
Contact material	AgNi		
Max. switching voltage	250 V AC/DC		
Minimum switching voltage	5 V (at 24 mA)		
Limiting continuous current	12 A		
Maximum switch-on current AC	30 A (20 ms, N/O contact)		
Maximum switch-on current DC	30 A (20 ms, N/O contact)		
Minimum switching current	5 mA (at 24 V)		
General data			
Test voltage (winding/contact)	2.5 kV _{rms} (50 Hz, 1 min.)		
Ambient temperature (operation), AC	-40°C ... 55°C		
Ambient temperature (operation), DC	-40°C ... 70°C		
Mechanical service life, AC	Approx. 2x 10 ⁷ cycles		
Mechanical service life, DC	Approx. 2x 10 ⁷ cycles		
Standards/regulations	IEC 60664, IEC 61810		

Input data	①	②	③
Permissible range (with reference to U_N)	See diagram		
Typical input current at U_N [mA]	38	14.8	7.1
Typical response time at U_N [ms]	13		
Typical response time at U_N (depending on phase relation) [ms]		5 - 15	5 - 15
Typical release time at U_N [ms]	3		
Typical release time at U_N (depending on phase relation) [ms]		5 - 20	5 - 20
Output data			
Contact type	4 PDTs		
Contact material	AgNi		
Max. switching voltage	250 V AC/DC		
Minimum switching voltage	5 V (at 24 mA)		
Limiting continuous current	6 A		
Maximum switch-on current AC	16 A (20 ms, N/O contact)		
Maximum switch-on current DC	16 A (20 ms, N/O contact)		
Minimum switching current	5 mA (at 24 V)		
General data			
Test voltage (winding/contact)	2.5 kV _{rms} (50 Hz, 1 min.)		
Ambient temperature (operation), AC	-40°C ... 55°C		
Ambient temperature (operation), DC	-40°C ... 70°C		
Mechanical service life, AC	1x 10 ⁷ cycles, approximately		
Mechanical service life, DC	1x 10 ⁷ cycles, approximately		
Standards/regulations	IEC 60664, IEC 61810		

Ordering data

Description	Input voltage U_N
Non-polarized plug-in industrial relays, with power contacts	
①	24 V DC
②	100 V AC
③	200 V AC

Type	Order No.	Pcs./Pkt.
REL-IR2/24DC/2X21	2907051	10
REL-IR2/100AC/2X21	2907052	10
REL-IR2/200AC/2X21	2907053	10

Ordering data

Type	Order No.	Pcs./Pkt.
REL-IR4/24DC/4X21	2907054	10
REL-IR4/100AC/4X21	2907055	10
REL-IR4/200AC/4X21	2907056	10

REL-IR2... (2 changeover contacts)

Operating voltage range

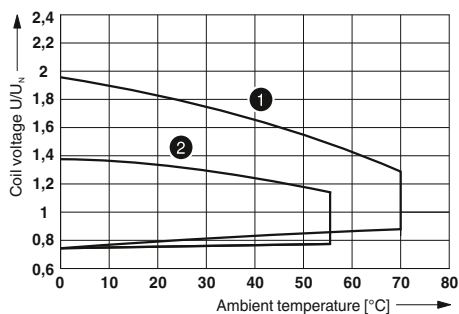

- ① DC coils
- ② AC coils

Interrupting rating

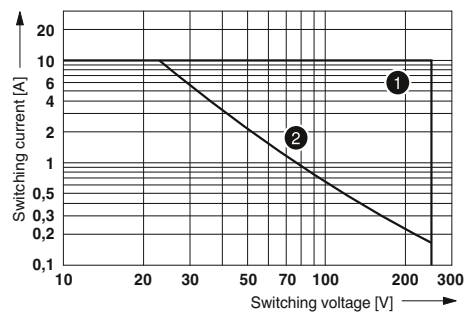

- ① AC, ohmic load
- ② DC, ohmic load

Electrical service life

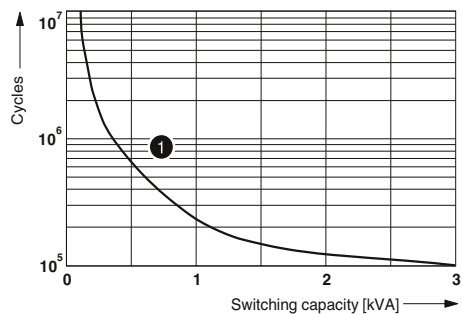

- ① 250 V AC, ohmic load

Service life reduction factor

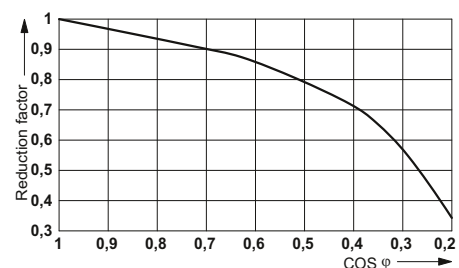

REL-IR4... (4 changeover contacts)

Operating voltage range

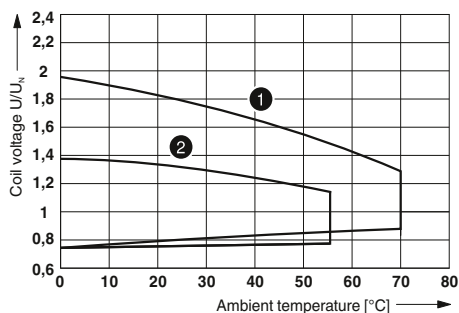

- ① DC coils
- ② AC coils

Interrupting rating

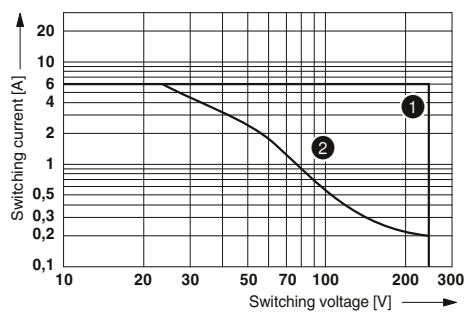

- ① AC, ohmic load
- ② DC, ohmic load

Electrical service life

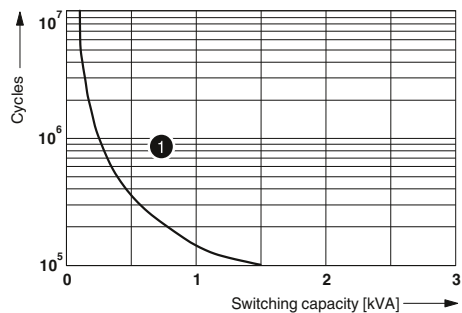

- ① 250 V AC, ohmic load

Service life reduction factor

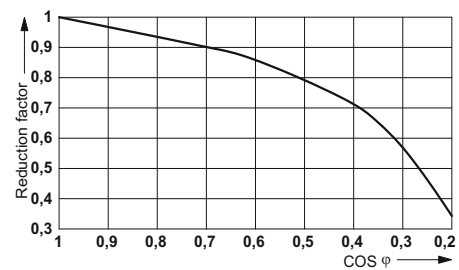

RIFLINE complete – Industrial relay system

Modular RIF-3 relay bases

Relay bases that can be fitted with 2 or 3 PDT relays.

Range of accessories includes:

- Plug-in interference suppression module
- Plug-in timer module
- Relay retaining bracket with ejector function and holder for marking material
- Comprehensive range of marking material
- Test plug
- FBS 2-6 plug-in bridges for the input side (A2)

Notes:
Type of insulating housing: Polyamide PA non-reinforced, color: gray.
For further marking systems and mounting material, see Catalog 3.
When mounting relays on a DIN rail base or PCB, data may be limited, especially with regard to the limiting continuous current and/or ambient temperature range. See "General" section in "Fundamentals of relay technology" on page 272



2-changeover-contact relay base with Push-in connection technology for octal relays



Nominal voltage U_N
Nominal current at U_N

General data
Ambient temperature (operation)
Connection data solid/stranded/AWG
Dimensions
Width
Depth with retaining bracket
Height

Technical data
250 V AC/DC Max. 12 A (depends on application/assembly)
-40°C ... 85°C (depends on application/assembly)
0.14 ... 1.5 mm ² / 0.14 ... 1.5 mm ² / 26 - 16
40 mm
90 mm
103 mm

Description
RIF-3 relay base , 2-PDT version, plug-in option for interference suppression module, safe isolation I/O with Push-in connection
RIF-3 relay base , 3-PDT version, plug-in option for interference suppression module, safe isolation I/O with Push-in connection
Plastic relay retaining bracket , with holder for marking material, suitable for RIF-3 relay base
Relay retaining bracket , wire model, suitable for RIF-3 relay base

Ordering data			
Type	Order No.	Pcs./Pkt.	
RIF-3-BPT/2X21	2900937	10	

Plug-in bridge 2-pos. red, 32 A 2-pos. red, 24 A 2-pos. blue, 32 A 2-pos. gray, 32 A End clamp , to snap on NS 35, 9.5 mm wide, can be labeled with ZB 6, ZB 8/27, KLM...	
Test plug , consisting of: Metal part for 2.3 mm Ø socket hole and	gray
Insulating sleeve , for MPS metal part	red white blue yellow green gray black
Zack marker strip, unprinted 10-section 5-section	
Double marker carrier for ZB 5	

Accessories			
Type	Order No.	Pcs./Pkt.	
FBS 2-6	3030336	50	
FBSR 2-6	3033715	50	
FBS 2-6 BU	3036932	50	
FBS 2-6 GY	3032237	50	
CLIPFIX 35	3022218	50	
MPS-MT	0201744	10	
MPS-IH RD	0201676	10	
MPS-IH WH	0201663	10	
MPS-IH BU	0201689	10	
MPS-IH YE	0201692	10	
MPS-IH GN	0201702	10	
MPS-IH GY	0201728	10	
MPS-IH BK	0201731	10	
ZB 5 :UNBEDRUCKT	1050004	10	
ZB 15:UNBEDRUCKT	0811972	10	
STP 5-2	0800967	100	



3-changeover-contact relay base with Push-in connection technology for octal relays



Plastic relay retaining bracket for RIF-3 base



Metal wire relay retaining bracket for RIF-3 base



Technical data
250 V AC/DC
Max. 12 A (depends on application/assembly)
-40°C ... 85°C (depends on application/assembly)
0.14 ... 1.5 mm ² / 0.14 ... 1.5 mm ² / 26 - 16
40 mm
90 mm
103 mm

Technical data
-
-
-
-
-
-
-

Technical data
-
-
-
-
-
-
-

Ordering data		
Type	Order No.	Pcs./Pkt.
RIF-3-BPT/3X21	2900938	10

Ordering data		
Type	Order No.	Pcs./Pkt.
RIF-RH-3	2900955	10

Ordering data		
Type	Order No.	Pcs./Pkt.
EL3-M52	2833628	10

Accessories		
FBS 2-6	3030336	50
FBSR 2-6	3033715	50
FBS 2-6 BU	3036932	50
FBS 2-6 GY	3032237	50
CLIPFIX 35	3022218	50
MPS-MT	0201744	10
MPS-IH RD	0201676	10
MPS-IH WH	0201663	10
MPS-IH BU	0201689	10
MPS-IH YE	0201692	10
MPS-IH GN	0201702	10
MPS-IH GY	0201728	10
MPS-IH BK	0201731	10
ZB 5 :UNBEDRUCKT	1050004	10
ZB 15:UNBEDRUCKT	0811972	10
STP 5-2	0800967	100

Accessories		

Accessories		

Modular RIF-3 relay bases

Relay bases for assembly with
2 or 3-changeover-contact octal relay.

Range of accessories includes:

- Plug-in interference suppression module
- Plug-in timer module
- Relay retaining bracket with ejector function and holder for marking material
- Comprehensive range of marking material
- Test plug
- FBS 2-6 plug-in bridges for the input side (A2)

Notes:
Type of insulating housing: Polyamide PA non-reinforced, color: gray.
For further marking systems and mounting material, see Catalog 3.
When mounting relays on a DIN rail base or PCB, data may be limited, especially with regard to the limiting continuous current and/or ambient temperature range. See "General" section in "Fundamentals of relay technology" on page 272

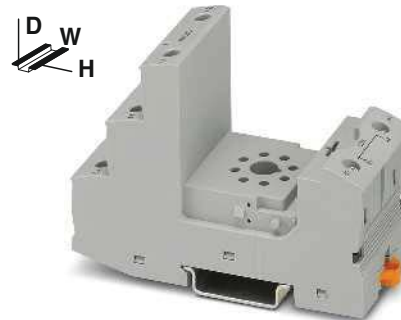

**2-changeover-contact relay base
with screw connection technology
for octal relays**



Technical data

Nominal voltage U_N
Nominal current at U_N

250 V AC/DC
Max. 12.5 A (depends on application/assembly)

General data
Ambient temperature (operation)

-40°C ... 85°C (depends on application/assembly)

Connection data solid/stranded/AWG
Dimensions
Width
Depth with retaining bracket
Height

0.5 ... 4 mm² / 0.5 ... 4 mm² / 20 - 10
40 mm
90 mm
96 mm

Ordering data

Description

RIF-3 relay base, 2-PDT version, plug-in option for interference
suppression module, safe isolation I/O with screw connection

Type	Order No.	Pcs./Pkt.
RIF-3-BSC/2X21	2900935	10

RIF-3 relay base, 3-PDT version, plug-in option for interference
suppression module, safe isolation I/O with screw connection

Plastic relay retaining bracket, with holder for marking material,
suitable for RIF-3 relay base

Relay retaining bracket, wire model, suitable for RIF-3 relay base

Accessories

Plug-in bridge

2-pos. red, 32 A
2-pos. red, 24 A
2-pos. blue, 32 A
2-pos. gray, 32 A

End clamp, to snap on NS 35, 9.5 mm wide, can be labeled
with ZB 6, ZB 8/27, KLM...

Test plug, consisting of:

Metal part for 2.3 mm Ø socket hole and gray

Insulating sleeve, for MPS metal part

red
white
blue
yellow
green
gray
black

Zack marker strip, unprinted

10-section
5-section

Double marker carrier for ZB 5

FBS 2-6	3030336	50
FBSR 2-6	3033715	50
FBS 2-6 BU	3036932	50
FBS 2-6 GY	3032237	50
CLIPFIX 35	3022218	50
MPS-MT	0201744	10
MPS-IH RD	0201676	10
MPS-IH WH	0201663	10
MPS-IH BU	0201689	10
MPS-IH YE	0201692	10
MPS-IH GN	0201702	10
MPS-IH GY	0201728	10
MPS-IH BK	0201731	10
ZB 5 :UNBEDRUCKT	1050004	10
ZB 15:UNBEDRUCKT	0811972	10
STP 5-2	0800967	100



3-changeover-contact relay base with screw connection technology for octal relays



Plastic relay retaining bracket for RIF-3 base



Metal wire relay retaining bracket for RIF-3 base



Technical data
250 V AC/DC
Max. 10.5 A (depends on application/assembly)
-40°C ... 85°C (depends on application/assembly)
0.5 ... 4 mm ² / 0.5 ... 4 mm ² / 20 - 10
40 mm
90 mm
96 mm

Technical data
-
-
-
-
-
-
-

Technical data
-
-
-
-
-
-
-

Ordering data		
Type	Order No.	Pcs./Pkt.
RIF-3-BSC/3X21	2900936	10

Ordering data		
Type	Order No.	Pcs./Pkt.
RIF-RH-3	2900955	10

Ordering data		
Type	Order No.	Pcs./Pkt.
EL3-M52	2833628	10

Accessories		
Type	Order No.	Pcs./Pkt.
FBS 2-6	3030336	50
FBSR 2-6	3033715	50
FBS 2-6 BU	3036932	50
FBS 2-6 GY	3032237	50
CLIPFIX 35	3022218	50
MPS-MT	0201744	10
MPS-IH RD	0201676	10
MPS-IH WH	0201663	10
MPS-IH BU	0201689	10
MPS-IH YE	0201692	10
MPS-IH GN	0201702	10
MPS-IH GY	0201728	10
MPS-IH BK	0201731	10
ZB 5 :UNBEDRUCKT	1050004	10
ZB 15:UNBEDRUCKT	0811972	10
STP 5-2	0800967	100

Accessories		
Type	Order No.	Pcs./Pkt.

Accessories		
Type	Order No.	Pcs./Pkt.

Plug-in octal relays

Plug-in octal relays with 2 or 3 changeover contacts, compatible for RIF-3 relay base.

The advantages:

- With lockable manual operation
- Mechanical switch position indicator
- Integrated status LED
- DC types with integrated free-wheeling diode



Octal relay with two changeover contacts with manual operation, 2 x 10 A, maximum



Octal relay with three changeover contacts with manual operation, 3 x 10 A, maximum

Notes:
For more voltages, see phoenixcontact.com/products
When mounting relays on a DIN rail base or PCB, data may be limited, especially with regard to the limiting continuous current and/or ambient temperature range. See "General" section in "Fundamentals of relay technology" on page 272

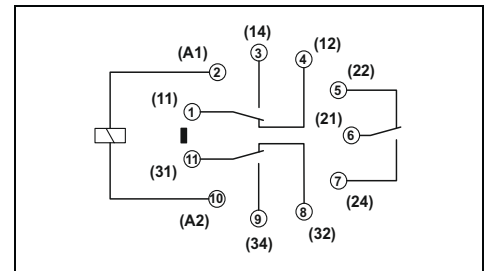
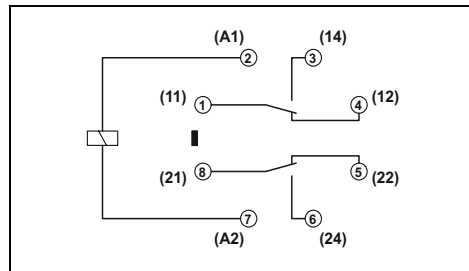

	Technical data					Technical data							
	①	⑤	⑥	⑦	⑧	①	②	③	④	⑤	⑥	⑦	⑧
Input data	See diagram					-							
Permissible range (with reference to U _N)	60					60							
Typical input current at U _N	[mA]	8	108	23	13	18	18	18	18	18	108	23	13
Typical response time at U _N	[ms]	18	18	5 - 15	5 - 15	18	18	18	18	18	5 - 15	5 - 15	5 - 15
Typical response time at U _N (depending on phase relation)	[ms]												
Typical release time at U _N	[ms]	20	7	5 - 20	5 - 20	20	20	20	20	7	5 - 20	5 - 20	5 - 20
Typical release time at U _N (depending on phase relation)	[ms]												
Input circuit AC	-	-	-	-	-	-	-	-	-	-	-	-	-
Input circuit DC	-	-	-	-	-	-	-	-	-	-	-	-	-
Output data	2 PDT					3 PDTs							
Contact type	AgNi					AgNi							
Contact material	250 V AC/DC					250 V DC / 440 V AC							
Max. switching voltage	10 V (at 24 mA)					10 V (at 24 mA)							
Minimum switching voltage	10 A					10 A							
Limiting continuous current	30 A (20 ms, N/O contact)					30 A (20 ms, N/O contact)							
Maximum switch-on current AC	30 A (20 ms, N/O contact)					30 A (20 ms, N/O contact)							
Maximum switch-on current DC	10 mA (at 24 V)					10 mA (at 24 V)							
Minimum switching current													
General data	2.5 kV _{rms} (50 Hz, 1 min.)					2.5 kV _{rms} (50 Hz, 1 min.)							
Test voltage (winding/contact)	-40°C ... 55°C					-40°C ... 55°C							
Ambient temperature (operation), AC	-40°C ... 70°C					-40°C ... 70°C							
Ambient temperature (operation), DC	100% operating factor					100% operating factor							
Nominal operating mode	Approx. 2x 10 ⁷ cycles					Approx. 2x 10 ⁷ cycles							
Mechanical service life, AC	Approx. 2x 10 ⁷ cycles					Approx. 2x 10 ⁷ cycles							
Mechanical service life, DC	IEC 60664, IEC 61810					IEC 60664, IEC 61810							
Standards/regulations	Any					Any							
Mounting position/mounting	35 mm / 35 mm / 54.4 mm					35 mm / 35 mm / 54.4 mm							
Dimensions	W / H / D					W / H / D							

			Ordering data			Ordering data		
Description	Input voltage U _N	Type	Order No.	Pcs./Pkt.	Type	Order No.	Pcs./Pkt.	
Plug-in octal relays, with power contacts								
With freewheeling diode	① 24 V DC	REL-OR2/LDP- 24DC/2X21	2903689	10	REL-OR3/LDP-24DC/3X21	2903693	10	
With freewheeling diode	② 48 V DC				REL-OR3/LDP-48DC/3X21	2908897	10	
With freewheeling diode	③ 110 V DC				REL-OR3/LDP-110DC/3X21	2908898	10	
With freewheeling diode	④ 125 V DC				REL-OR3/LDP-125DC/3X21	2909207	10	
With freewheeling diode	⑤ 220 V DC	REL-OR2/LDP-220DC/2X21	2907026	10	REL-OR3/LDP-220DC/3X21	2907027	10	
	⑥ 24 V AC	REL-OR2/L- 24AC/2X21	2903690	10	REL-OR3/L- 24AC/3X21	2903694	10	
	⑦ 120 V AC	REL-OR2/L-120AC/2X21	2903691	10	REL-OR3/L-120AC/3X21	2903695	10	
	⑧ 230 V AC	REL-OR2/L-230AC/2X21	2903692	10	REL-OR3/L-230AC/3X21	2903696	10	

REL-OR2... (2 changeover contacts)

Operating voltage range

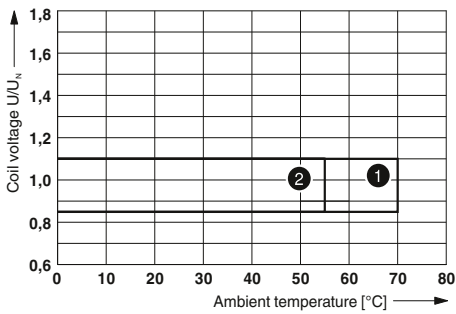

- ① DC coils
- ② AC coils

Interrupting rating

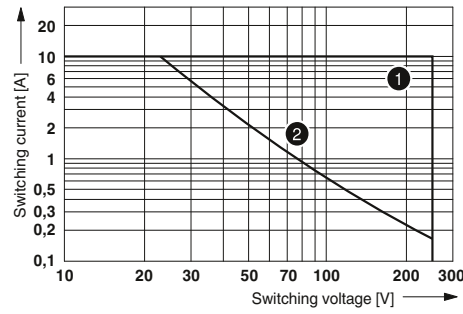

- ① AC, ohmic load
- ② DC, ohmic load

Electrical service life

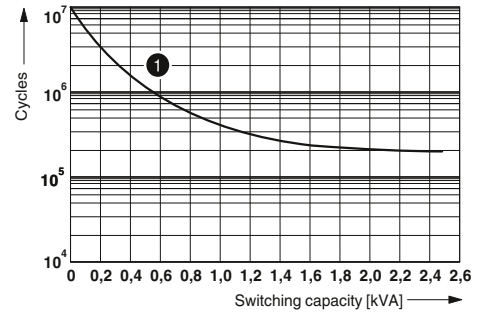

- ① 250 V AC, ohmic load

Service life reduction factor

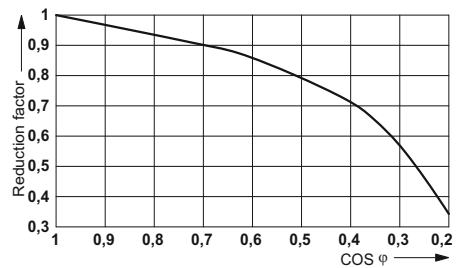

REL-OR3... (3 changeover contacts)

Operating voltage range

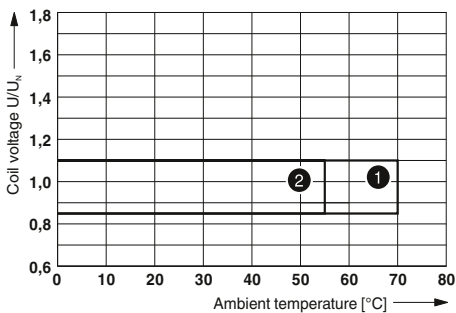

- ① DC coils
- ② AC coils

Interrupting rating

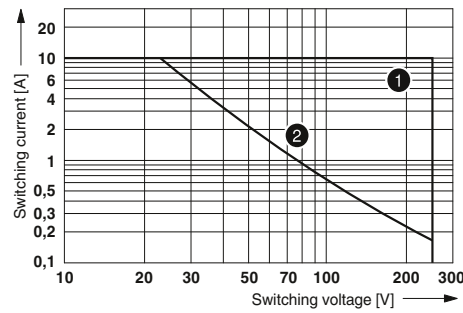

- ① AC, ohmic load
- ② DC, ohmic load

Electrical service life

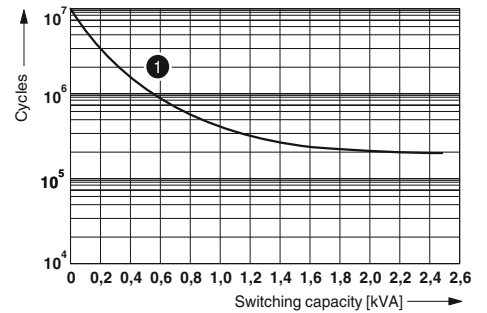

- ① 250 V AC, ohmic load

Service life reduction factor

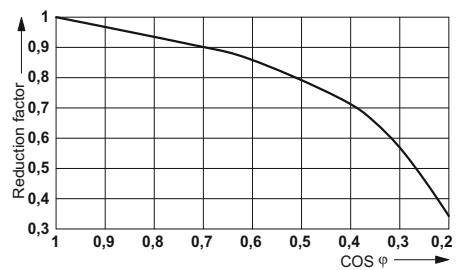

RIFLINE complete – Industrial relay system

Modular RIF-4 relay bases

Relay bases that can be fitted with 2 or 3 PDT relays or 3 N/O relays.

Range of accessories includes:

- Plug-in interference suppression module
- Plug-in timer module
- Relay retaining bracket with ejector function and holder for marking material
- Comprehensive range of marking material
- Test plug
- FBS 2-6 plug-in bridges for the input side (A2)

Notes:
Type of insulating housing: Polyamide PA non-reinforced, color: gray.
For further marking systems and mounting material, see Catalog 3.
When mounting relays on a DIN rail base or PCB, data may be limited, especially with regard to the limiting continuous current and/or ambient temperature range. See "General" section in "Fundamentals of relay technology" on page 272



3-changeover-contact relay base with Push-in connection technology for high-power relays



Technical data

440 V AC / 250 V DC
Max. 16 A (depends on application/assembly)

-40°C ... 85°C (depends on application/assembly)

0.14 ... 1.5 mm² / 0.14 ... 1.5 mm² / 26 - 16
0.14 ... 2.5 mm² / 0.14 ... 2.5 mm² / 26 - 14

43 mm
90 mm
111 mm

Ordering data

Type	Order No.	Pcs./Pkt.
RIF-4-BPT/3X21	2900961	10

Accessories

FBS 2-6	3030336	50
FBSR 2-6	3033715	50
FBS 2-6 BU	3036932	50
FBS 2-6 GY	3032237	50
CLIPFIX 35	3022218	50
MPS-MT	0201744	10
MPS-IH RD	0201676	10
MPS-IH WH	0201663	10
MPS-IH BU	0201689	10
MPS-IH YE	0201692	10
MPS-IH GN	0201702	10
MPS-IH GY	0201728	10
MPS-IH BK	0201731	10
ZB 5 :UNBEDRUCKT	1050004	10
ZB 15:UNBEDRUCKT	0811972	10
STP 5-2	0800967	100

Nominal voltage U_N
Nominal current at U_N

General data
Ambient temperature (operation)

Connection data solid/stranded/AWG
Input side
Output side
Dimensions
Width
Depth with retaining bracket
Height

Description
RIF-4 relay base , plug-in option for interference suppression module, safe isolation I/O with Push-in connection
RIF-4 relay base , plug-in option for interference suppression module, safe isolation I/O with screw connection
Relay retaining bracket , with holder for marking material, suitable for RIF-4 relay base
Relay retaining bracket , wire model, suitable for RIF-4 relay base

Plug-in bridge 2-pos. red, 32 A 2-pos. red, 24 A 2-pos. blue, 32 A 2-pos. gray, 32 A
End clamp , to snap on NS 35, 9.5 mm wide, can be labeled with ZB 6, ZB 8/27, KLM...
Test plug , consisting of: Metal part for 2.3 mm Ø socket hole and gray
Insulating sleeve , for MPS metal part red white blue yellow green gray black
Zack marker strip, unprinted 10-section 5-section
Double marker carrier for ZB 5

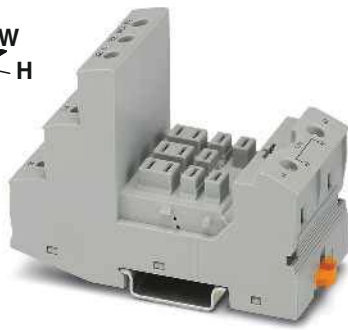

3-changeover-contact relay base with screw connection technology for high-power relays



Plastic relay retaining bracket for RIF-4 base



Metal wire relay retaining bracket for RIF-4 base



Technical data
440 V AC / 250 V DC
Max. 13 A (depends on application/assembly)
-40°C ... 85°C (depends on application/assembly)
0.5 ... 4 mm ² / 0.5 ... 4 mm ² / 20 - 10
0.5 ... 4 mm ² / 0.5 ... 4 mm ² / 20 - 10
44 mm
91 mm
96 mm

Technical data
-
-
-
-
-
-
-
-

Technical data
-
-
-
-
-
-
-
-

Ordering data		
Type	Order No.	Pcs./Pkt.
RIF-4-BSC/3X21	2900960	10

Ordering data		
Type	Order No.	Pcs./Pkt.
RIF-RH-4	2900956	10

Ordering data		
Type	Order No.	Pcs./Pkt.
RIF-RHM-4	2905983	10

Accessories		

Accessories		

Accessories		

Relay modules

RIFLINE complete – Industrial relay system

Plug-in high-power relays

Plug-in high-power relays with 2 or 3 PDT contacts for the RIF-4 relay base.

The advantages:

- Use in miniature contactor applications
- Switching current of up to 16 A
- Up to 440 V AC switching voltage

Notes:
For more voltages, see phoenixcontact.com/products
When mounting relays on a DIN rail base or PCB, data may be limited, especially with regard to the limiting continuous current and/or ambient temperature range. See "General" section in "Fundamentals of relay technology" on page 272



High-power relay with two changeover contacts, 2 x 16 A, maximum



High-power relay with three changeover contacts, 3 x 16 A, maximum

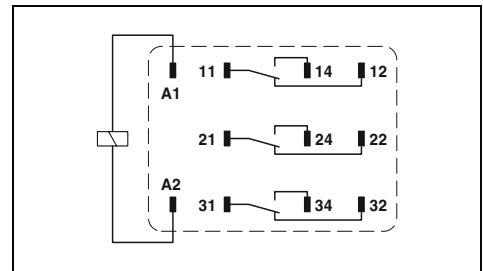
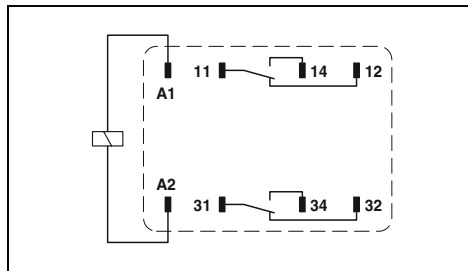

	Technical data			
	①	②	③	④
Input data	See diagram			
Permissible range (with reference to U_N)	56	116	23	12
Typical input current at U_N [mA]	20			
Typical response time at U_N [ms]		5 - 25	5 - 25	5 - 25
Typical response time at U_N (depending on phase relation) [ms]				
Typical release time at U_N [ms]	15			
Typical release time at U_N (depending on phase relation) [ms]		5 - 20	5 - 20	5 - 20
Output data				
Contact type	2 PDT			
Contact material	AgNi			
Max. switching voltage	440 V AC / 250 V DC			
Minimum switching voltage	10 V (at 24 mA)			
Limiting continuous current	16 A			
Maximum switch-on current AC	50 A (20 ms, N/O contact)			
Maximum switch-on current DC	50 A (20 ms, N/O contact)			
Minimum switching current	10 mA (at 24 V)			
Maximum interrupting rating, ohmic load	250 V AC	4,000 VA		
	440 V AC	4,000 VA		
Motor load in accordance with UL 508		1/3 HP, 120 V AC (N/O contact)		
		1/2 HP, 240 V AC (N/O contact)		
General data				
Test voltage (winding/contact)	2.5 kV _{rms} (50 Hz, 1 min.)			
Ambient temperature (operation), AC	-40°C ... 55°C			
Ambient temperature (operation), DC	-40°C ... 70°C			
Nominal operating mode	100% operating factor			
Mechanical service life, AC	Approx. 10 ⁷ cycles			
Mechanical service life, DC	Approx. 10 ⁷ cycles			
Standards/regulations	IEC 60664, IEC 61810			
Mounting position/mounting	Any			
Dimensions	W / H / D 38.6 mm / 36.1 mm / 45.5 mm			

	Technical data					
	①	②	③	④	⑤	⑥
Input data	See diagram					
Permissible range (with reference to U_N)	56	12	6	116	23	12
Typical input current at U_N [mA]	20	20	20			
Typical response time at U_N [ms]				5 - 25	5 - 25	5 - 25
Typical response time at U_N (depending on phase relation) [ms]						
Typical release time at U_N [ms]	15	15	15			
Typical release time at U_N (depending on phase relation) [ms]				5 - 20	5 - 20	5 - 20
Output data						
Contact type	3 PDTs					
Contact material	AgNi					
Max. switching voltage	440 V AC / 250 V DC					
Minimum switching voltage	10 V (at 24 mA)					
Limiting continuous current	16 A					
Maximum switch-on current AC	50 A (20 ms, N/O contact)					
Maximum switch-on current DC	50 A (20 ms, N/O contact)					
Minimum switching current	10 mA (at 24 V)					
Maximum interrupting rating, ohmic load	4,000 VA					
	4,000 VA					
Motor load in accordance with UL 508				1/3 HP, 120 V AC (single-phase AC motor)		
				1/2 HP, 240 V AC (single-phase AC motor)		
				1/2 HP, 240 V AC (three-phase induction motor)		
General data						
Test voltage (winding/contact)	2.5 kV _{rms} (50 Hz, 1 min.)					
Ambient temperature (operation), AC	-40°C ... 55°C					
Ambient temperature (operation), DC	-40°C ... 70°C					
Nominal operating mode	100% operating factor					
Mechanical service life, AC	Approx. 10 ⁷ cycles					
Mechanical service life, DC	Approx. 10 ⁷ cycles					
Standards/regulations	IEC 60664, IEC 61810					
Mounting position/mounting	Any					
Dimensions	38.6 mm / 36.1 mm / 45.5 mm					

Description	Input voltage U_N	Ordering data		
		Type	Order No.	Pcs./Pkt.
Plug-in high-power relays, 2 PDTs with power contacts	① 24 V DC	REL-PR2- 24DC/2X21	2903698	1
	② 24 V AC	REL-PR2- 24AC/2X21	2903699	1
	③ 120 V AC	REL-PR2-120AC/2X21	2903700	1
	④ 230 V AC	REL-PR2-230AC/2X21	2903701	1
Plug-in high-power relays, 3 PDTs with power contacts	① 24 V DC			
	② 110 V DC			
	③ 220 V DC			
	④ 24 V AC			
	⑤ 120 V AC			

Type	Order No.	Pcs./Pkt.	Ordering data		
			Type	Order No.	Pcs./Pkt.
			REL-PR3- 24DC/3X21	2903702	1
			REL-PR3-110DC/3X21	2908893	1
			REL-PR3-220DC/3X21	2909055	1
			REL-PR3- 24AC/3X21	2903703	1
			REL-PR3-120AC/3X21	2903704	1

REL-PR2... (2 changeover contacts)

Operating voltage range

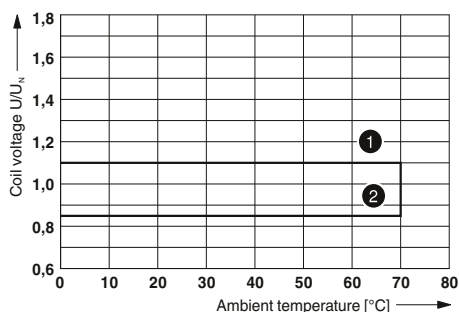

- ① Maximum continuous voltage at limiting continuous current = 16 A
- ② Minimum operate voltage
For pre-excitation with UN and limiting continuous current = 16 A

Interrupting rating

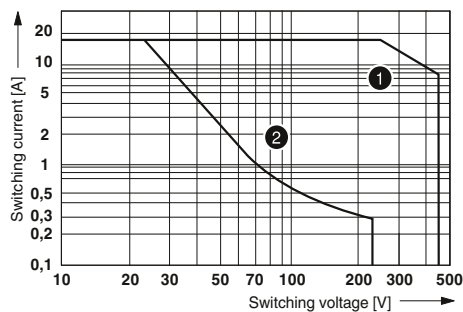

- ① AC, ohmic load
- ② DC, ohmic load

Electrical service life

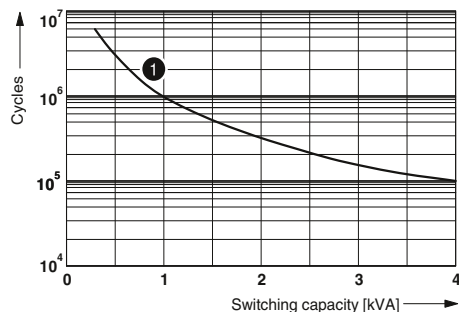

- ① 250 V AC, ohmic load

Service life reduction factor

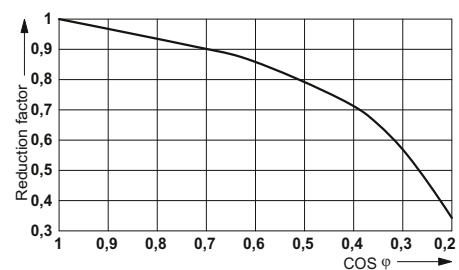

REL-PR3... (3 changeover contacts)

Operating voltage range

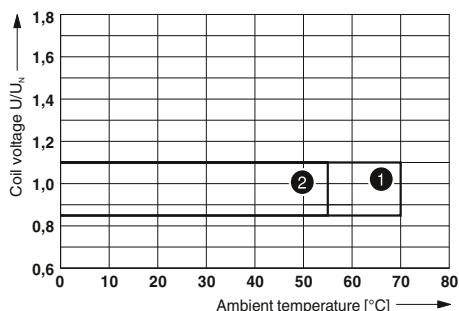

- ① DC coils
- ② AC coils

Interrupting rating

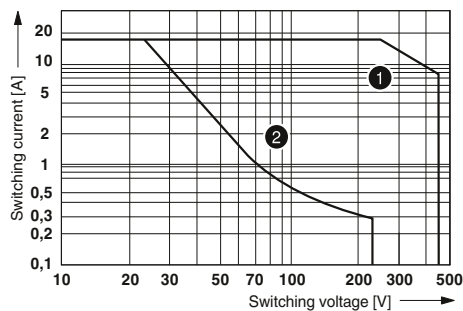

- ① AC, ohmic load
- ② DC, ohmic load

Electrical service life

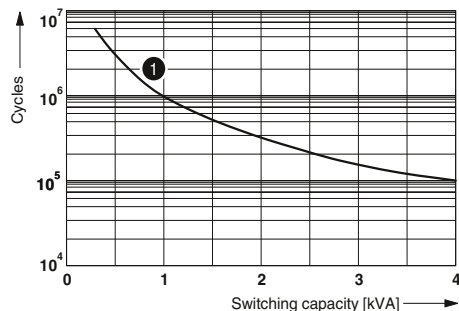

- ① 250 V AC, ohmic load

Service life reduction factor

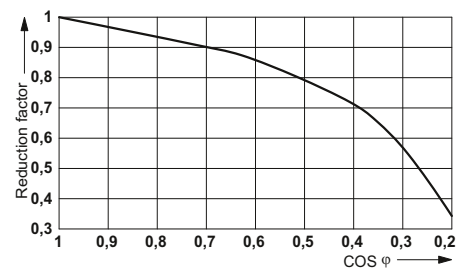

Plug-in high-power relays

Plug-in high-power relays with 3 N/O contacts suitable for the RIF-4 relay base.

The advantages:

- Use in miniature contactor applications
- Switching current of up to 16 A
- Up to 440 V AC switching voltage
- Full shutdown by means of ≥ 3 mm contact opening

Notes:

When mounting relays on a DIN rail base or PCB, data may be limited, especially with regard to the limiting continuous current and/or ambient temperature range. See "General" section in "Fundamentals of relay technology" on page 272



High-power relay with three N/O contacts, 3 x 16 A, maximum



High-power relay with one N/O contact with blowing magnet for switching high DC loads

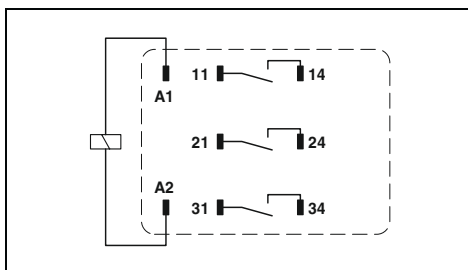

Technical data

Input data	①	②	③	④
Permissible range (with reference to U_N)	See diagram			
Typical input current at U_N [mA]	70	116	23	12
Typical response time at U_N [ms]	20			
Typical response time at U_N (depending on phase relation) [ms]		5 - 25	5 - 25	5 - 25
Typical release time at U_N [ms]	15			
Typical release time at U_N (depending on phase relation) [ms]		5 - 20	5 - 20	5 - 20
Output data				
Contact type	3 N/O contacts			
Contact material	AgNi			
Max. switching voltage	440 V AC / 250 V DC			
Minimum switching voltage	10 V (at 24 mA)			
Limiting continuous current	16 A			
Maximum switch-on current AC	50 A (20 ms, N/O contact)			
Maximum switch-on current DC	50 A (20 ms, N/O contact)			
Minimum switching current	10 mA (at 24 V)			
Maximum interrupting rating, ohmic load	250 V AC	4,000 VA		
	440 V AC	4,000 VA		
Motor load in accordance with UL 508		1/3 HP, 120 V AC (N/O contact)		1/2 HP, 240 V AC (N/O contact)
General data				
Test voltage (winding/contact)	2.5 kV _{rms} (50 Hz, 1 min.)			
Ambient temperature (operation), AC	-40°C ... 55°C			
Ambient temperature (operation), DC	-40°C ... 70°C			
Nominal operating mode	100% operating factor			
Mechanical service life, AC	Approx. 10 ⁷ cycles			
Mechanical service life, DC	Approx. 10 ⁷ cycles			
Standards/regulations	IEC 60664, IEC 61810			
Mounting position/mounting	Any			
Dimensions	W / H / D 38.6 mm / 36.1 mm / 45.5 mm			

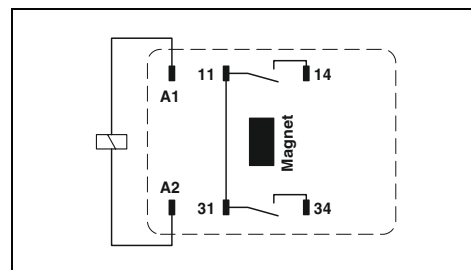

Technical data

Input data	①	②	③	④
Permissible range (with reference to U_N)	See diagram			
Typical input current at U_N [mA]	70	15	7.3	12
Typical response time at U_N [ms]	20	20	20	
Typical response time at U_N (depending on phase relation) [ms]				5 - 25
Typical release time at U_N [ms]	15	15	15	
Typical release time at U_N (depending on phase relation) [ms]				5 - 18
Output data				
Contact type	1 N/O contact			
Contact material	AgNi			
Max. switching voltage	440 V AC / 250 V DC			
Minimum switching voltage	5 V (at 24 mA)			
Limiting continuous current	16 A			
Maximum switch-on current AC	50 A (20 ms)			
Maximum switch-on current DC	50 A (20 ms)			
Minimum switching current	5 mA (at 24 V)			
Maximum interrupting rating, ohmic load	250 V AC	4,000 VA		
	440 V AC	-		
Motor load in accordance with UL 508				
General data				
Test voltage (winding/contact)	2.5 kV			
Ambient temperature (operation), AC	-40°C ... 70°C			
Ambient temperature (operation), DC	-40°C ... 70°C			
Nominal operating mode	100% operating factor			
Mechanical service life, AC	Approx. 2x 10 ⁷ cycles			
Mechanical service life, DC	Approx. 2x 10 ⁷ cycles			
Standards/regulations	IEC 60664, IEC 61810			
Mounting position/mounting	Any			
Dimensions	38.6 mm / 36.1 mm / 45.5 mm			

Ordering data

Description	Input voltage U_N	Type	Order No.	Pcs./Pkt.
Plug-in high-power relays, 3 N/O contacts with power contacts	① 24 V DC	REL-PR3-24DC/3X1	2903706	1
	② 24 V AC	REL-PR3-24AC/3X1	2903707	1
	③ 120 V AC	REL-PR3-120AC/3X1	2903708	1
	④ 230 V AC	REL-PR3-230AC/3X1	2903709	1
Plug-in high-power relays, 1-N/O contact with blow magnet and power contacts	① 24 V DC	REL-PR1-24DC/1/MB	2908040	1
	② 110 V DC	REL-PR1-110DC/1/MB	2908044	1
	③ 220 V DC	REL-PR1-220DC/1/MB	2908046	1
	④ 230 V AC	REL-PR1-230AC/1/MB	2908047	1

Ordering data

Description	Input voltage U_N	Type	Order No.	Pcs./Pkt.
Plug-in high-power relays, 1-N/O contact with blow magnet and power contacts	① 24 V DC	REL-PR1-24DC/1/MB	2908040	1
	② 110 V DC	REL-PR1-110DC/1/MB	2908044	1
	③ 220 V DC	REL-PR1-220DC/1/MB	2908046	1
	④ 230 V AC	REL-PR1-230AC/1/MB	2908047	1

REL-PR3... (3 N/O contacts)

Operating voltage range

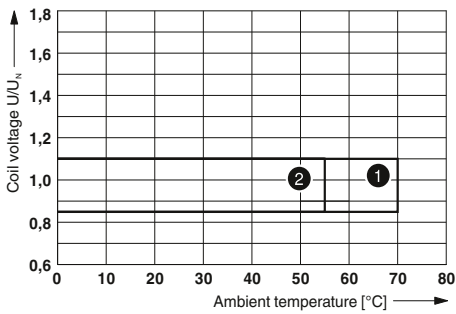

- ① DC coils
- ② AC coils

Interrupting rating

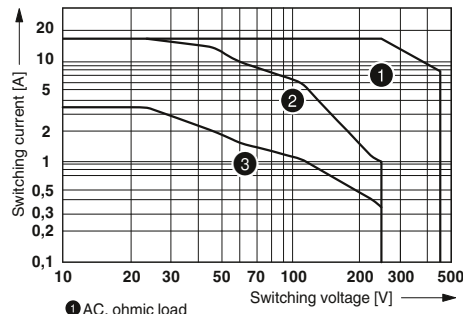

- ① AC, ohmic load
- ② DC, ohmic load
- ③ DC, L/R = 40 ms

Electrical service life

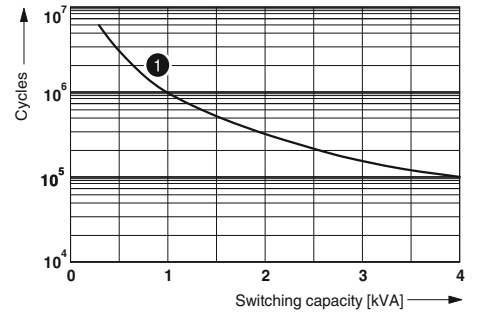

- ① 250 V AC, ohmic load

Service life reduction factor

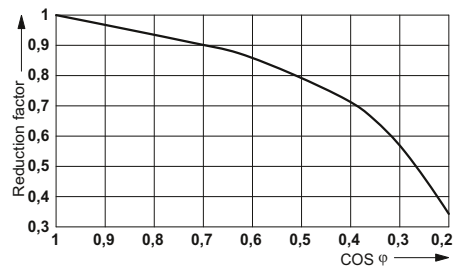

REL-PR1... (1 N/O contact with blow magnet)

Operating voltage range

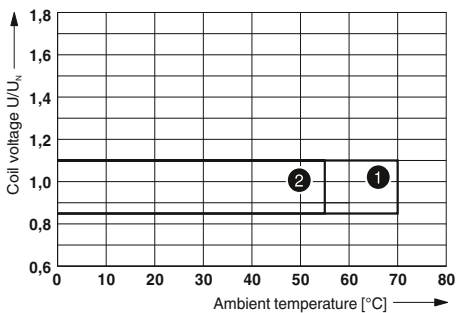

- ① DC coils
- ② AC coils

Interrupting rating

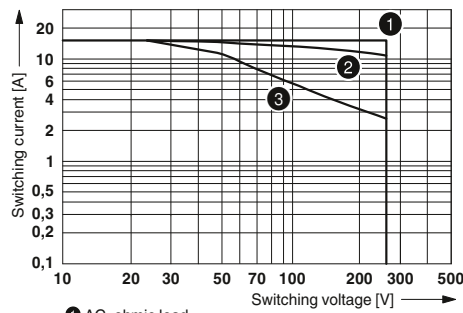

- ① AC, ohmic load
- ② DC, ohmic load
- ③ DC, L/R = 40 ms

Plug-in interference suppression modules for RIF-1, RIF-2, RIF-3, and RIF-4

Plug-in interference suppression modules for optional assembly of RIF-1 to RIF-4 relay bases.

The advantages:

- Attenuation of reverse voltage induced in coil
- Mechanical coding to protect against incorrect connection



Interference suppression modules for RIF-1 to RIF-4



Ordering data			
Description	Type	Order No.	Pcs./Pkt.
Plug-in module, with LED status indicator and freewheeling diode to effectively limit the coil induction voltage, polarity: A1+ , A2- , input voltage: - 12-24 V DC \pm 20% - 48-60 V DC \pm 20% - 110 V DC \pm 20%	RIF-LDP-12-24 DC RIF-LDP-48-60 DC RIF-LDP-110 DC	2900939 2900940 2900941	10 10 10
Plug-in module, with LED status indicator and varistor to limit the coil induction voltage and/or external interference peaks, input voltage: - 12-24 V AC/DC \pm 20% (30-V-varistor) - 48-60 V AC/DC \pm 20% (75-V-varistor) - 120-230 V AC/110 V DC \pm 20% (275-V-varistor)	RIF-LV-12-24 UC RIF-LV-48-60 UC RIF-LV-120-230 AC/110 DC	2900942 2900943 2900944	10 10 10
Plug-in module, with varistor to limit the coil induction voltage and/or external interference peaks, input voltage: - 12-24 V AC/DC \pm 20% (30-V-varistor) - 48-60 V AC/DC \pm 20% (75-V-varistor) - 120-230 V AC/DC \pm 20% (275-V-varistor)	RIF-V-12-24 UC RIF-V-48-60 UC RIF-V-120-230 UC	2900945 2900947 2900948	10 10 10
Plug-in module, with RC element to limit the coil induction voltage and/or external interference peaks, input voltage: - 12-24 V AC/DC \pm 20% (220 nF/100 Ω) - 48-60 V AC/DC \pm 20% (220 nF/220 Ω) - 120 - 230 V AC/DC \pm 20% (100 nF/470 Ω)	RIF-RC-12-24 UC RIF-RC-48-60 UC RIF-RC-120-230 UC	2900949 2900950 2900951	10 10 10
Plug-in module, with bridge rectifier for controlling electromechanical DC voltage relay, input voltage: - 12 ... 230 V AC	RIF-BR-12-230 AC	2907060	10
Plug-in module, with LED status indicator and freewheeling diode to effectively limit the coil induction voltage, polarity: A1- , A2+ , input voltage: - 12-24 V DC \pm 20%	RIF-LDM-12-24 DC	2907057	10
Plug-in module, with LED status indicator and varistor to limit the coil induction voltage and/or external interference peaks, polarity A1- , A2+ , input voltage: - 120-230 V AC/110 V DC \pm 20% (275-V-varistor)	RIF-LVM-100-200 AC/110 DC	2907058	10

Plug-in timer modules for RIF-1, RIF-2, RIF-3, and RIF-4

The multifunctional plug-in timer module transforms a relay module into a timer relay. RIF-1 to RIF-4 bases can be equipped with this module. Using DIP switches, three time functions and four time ranges can be selected. Detailed time settings are made using a potentiometer. Relays can be operated with an input voltage of 12, or 24 V AC/DC.

The time functions:

- With switch-on delay
- With passing make contact
- Pulse generator

Time ranges:

- 0.5 to 10 s
- 5 to 100 s
- 0.5 to 10 min
- 5 to 100 min



Timer module for RIF-1 to RIF-4 relay modules for 12 to 24 V AC/DC input voltage

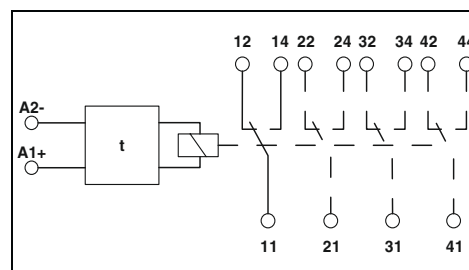

With switch-on delay

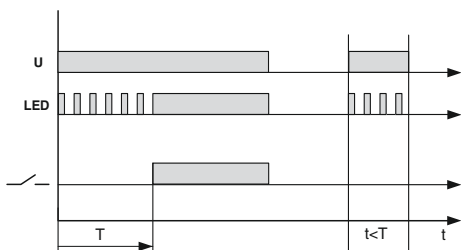

Passing make contact

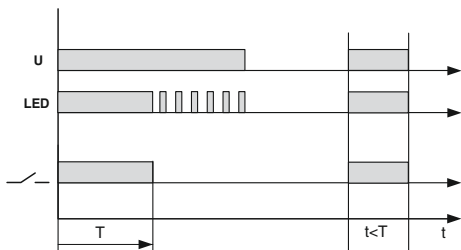

Pulse generator

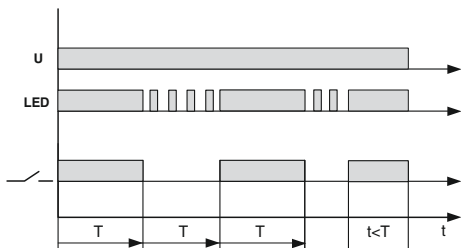

Input data	Nominal input voltage U_N
Nominal input voltage range with reference to U_N	0.4 ... 1.2
Input circuit	Varistor, yellow LED
Output data	Limiting continuous current
Limiting continuous current	≤ 250 mA (relay coil current)
General data	Mounting position
Mounting position	any
Repeat accuracy	1%
Ambient temperature (operation)	-25°C ... 50°C (RIF-1, AC coil, 2 PDTs at 6 A) -25°C ... 50°C (RIF-1, DC coil, 2 PDTs at 5 A) -25°C ... 40°C (RIF-2, DC coil, 2 PDTs at 8 A) -25°C ... 40°C (RIF-2, DC coil, 4 PDTs at 5 A) -25°C ... 40°C (RIF-3, DC coil, 3 PDTs at 6.75 A) -25°C ... 40°C (RIF-3, DC coil, 2 PDTs at 8 A) -25°C ... 35°C (RIF-4, DC coil, 3 PDTs at 8 A) -25°C ... 25°C (RIF-4, DC coil, 3 N/O contacts at 8 A)
Standards/specifications	DIN EN 50178
Rated insulation voltage	50 V DC
Rated surge voltage	0.4 kV

Technical data

24 V DC (AC operation only permitted for RIF-1)

0.4 ... 1.2
Varistor, yellow LED

≤ 250 mA (relay coil current)

any
1%
-25°C ... 50°C (RIF-1, AC coil, 2 PDTs at 6 A)
-25°C ... 50°C (RIF-1, DC coil, 2 PDTs at 5 A)
-25°C ... 40°C (RIF-2, DC coil, 2 PDTs at 8 A)
-25°C ... 40°C (RIF-2, DC coil, 4 PDTs at 5 A)
-25°C ... 40°C (RIF-3, DC coil, 3 PDTs at 6.75 A)
-25°C ... 40°C (RIF-3, DC coil, 2 PDTs at 8 A)
-25°C ... 35°C (RIF-4, DC coil, 3 PDTs at 8 A)
-25°C ... 25°C (RIF-4, DC coil, 3 N/O contacts at 8 A)
DIN EN 50178
50 V DC
0.4 kV

Description	Timer module , for mounting on RIF-1 to RIF-4, with LED status indicator for extending a relay module to create a timer relay with an input voltage of 24 V AC/DC
--------------------	--

Ordering data

Type	Order No.	Pcs./Pkt.
RIF-T3-24UC	2902647	1

Fully mounted RIF-0 relay modules

Fully mounted RIF-0 relay modules, consisting of:

- Relay base with Push-in connection
- 1 N/O contact or 1 PDT relay
- Relay ejector lever on the housing

The advantages:

- Status LED integrated in the relay base
- Operational reliability, thanks to sealed relay
- Safe isolation between coil and contact side
- Professional bridging of adjacent modules saves wiring time
- For FBS 2-6 plug-in bridges for the input and output side, see page 358

Notes:

If the specified maximum values for multi-layer contact relays are exceeded, the gold plating is destroyed. The maximum values of the power contact relay are then valid. This can result in a shorter service life than with a pure power contact.

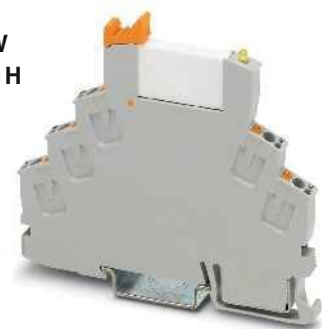

1-changeover-contact relay module with Push-in connection

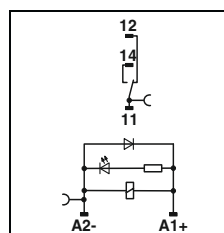

DC coils

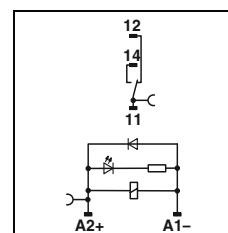

DC coil negative switching

Technical data

Input data	①	②
Permissible range (with reference to U_N)	See diagram	
Typical input current at U_N [mA]	16	9
Typical response time at U_N [ms]	5	5
Typical release time at U_N [ms]	8	8
Input protection:	Yellow LED, damping diode	
Output data		
Contact type	1 PDT	1 PDT
Contact material	AgSnO	AgSnO, hard gold-plated
Max. switching voltage	250 V AC/DC	30 V AC / 36 V DC
Minimum switching voltage	5 V (at 100 mA)	100 mV (at 10 mA)
Limiting continuous current	6 A	50 mA
Minimum switching current	10 mA (at 12 V)	1 mA
General data		
Test voltage (winding/contact)	4 kV _{rms} (50 Hz, 1 min.)	
Ambient temperature (operation)	-40°C ... 60°C	
Nominal operating mode	100% operating factor	
Mechanical service life	Approx. 2x 10 ⁷ cycles	
Standards/regulations	DIN EN 50178	
Degree of pollution/surge voltage category	2 / III	
Mounting position/mounting	Any / in rows with zero spacing	
Connection data solid/stranded/AWG	0.14 ... 1.5 mm ² / 0.14 ... 1.5 mm ² / 24 - 16	
Dimensions	W / H / D 6.2 mm / 93 mm / 78 mm	
EMC note	Class A product, see page 583	

Ordering data

Description	Input voltage U_N	Type	Order No.	Pcs./Pkt.
Coupling relay modules with power contact relay and Push-in connection	① 12 V DC	RIF-0-RPT-12DC/21	2903371	10
	② 24 V DC	RIF-0-RPT-24DC/21	2903370	10
Coupling relay modules with multi-layer gold contact relay, with Push-in connection	① 12 V DC	RIF-0-RPT-12DC/21AU	2903369	10
	② 24 V DC	RIF-0-RPT-24DC/21AU	2903368	10
Coupling relay modules with power contact relay and Push-in connection, negative switching	② 24 V DC	RIF-0-RPT-M-24DC/21	2908327	10



1-N/O-contact relay module with Push-in connection

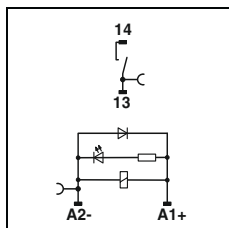

DC coils

Technical data

①	②
See diagram	
16	9
5	5
8	8
Yellow LED, damping diode	

1 N/O contact	1 N/O contact
AgSnO	AgSnO, hard gold-plated
250 V AC/DC	30 V AC / 36 V DC
5 V (at 100 mA)	100 mV (at 10 mA)
6 A	50 mA
10 mA (at 12 V)	1 mA (at 12 V)

4 kV_{rms} (50 Hz, 1 min.)
 -40°C ... 60°C
 100% operating factor
 Approx. 2x 10⁷ cycles
 DIN EN 50178
 2 / III

Any / in rows with zero spacing
 0.14 ... 1.5 mm² / 0.14 ... 1.5 mm² / 24 - 16
 6.2 mm / 93 mm / 66 mm
 Class A product, see page 583

Ordering data

Type	Order No.	Pcs./Pkt.
RIF-0-RPT-12DC/ 1	2903362	10
RIF-0-RPT-24DC/ 1	2903361	10
RIF-0-RPT-12DC/ 1AU	2903360	10
RIF-0-RPT-24DC/ 1AU	2903359	10

RIF-0-RPT.../21... (1 changeover contact)

Operating voltage range

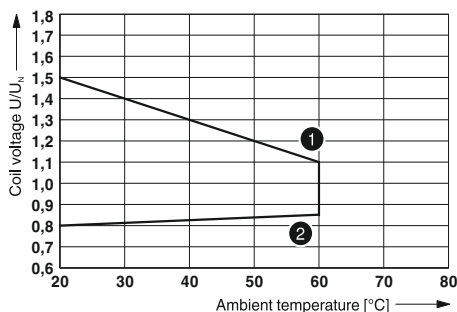

Interrupting rating

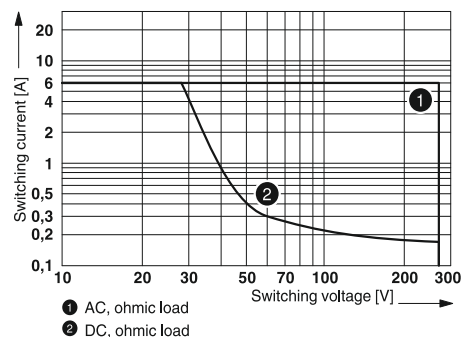

Service life reduction factor

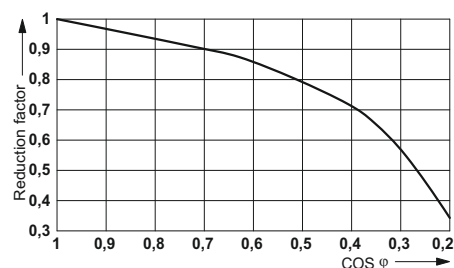

Electrical service life

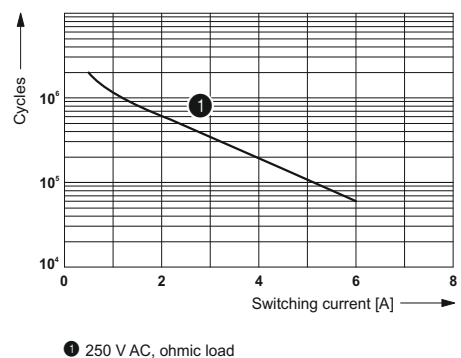

RIF-0-RPT.../1... (1 N/O contact)

Operating voltage range

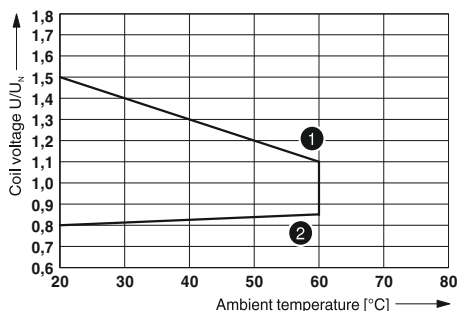

Interrupting rating

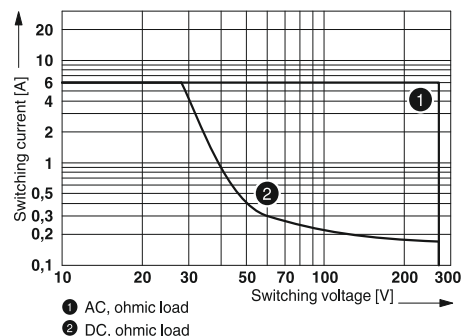

Service life reduction factor

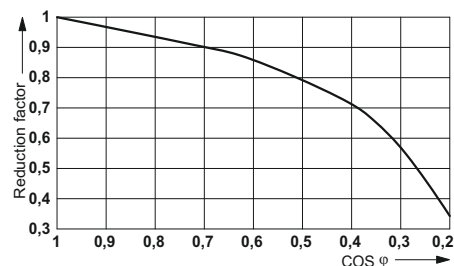

Electrical service life

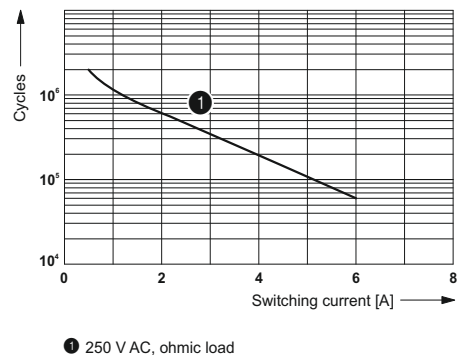

Fully mounted RIF-0 relay modules

Fully mounted RIF-0 relay modules, consisting of:

- Relay base with screw connection
- 1-PDT or 1-N/O-contact relay
- Relay ejector lever on the housing

The advantages:

- Status LED integrated in the relay base
- Operational reliability, thanks to sealed relay
- Safe isolation between coil and contact side
- Professional bridging of adjacent modules saves wiring time
- For FBS 2-6 plug-in bridges for the input and output side, see page 358

Notes:

General conditions:

Direct alignment in the block, all devices 100% operating time, horizontal or vertical mounting.

If the specified maximum values for multi-layer contact relays are exceeded, the gold plating is destroyed. The maximum values of the power contact relay are then valid. This can result in a shorter service life than with a pure power contact.

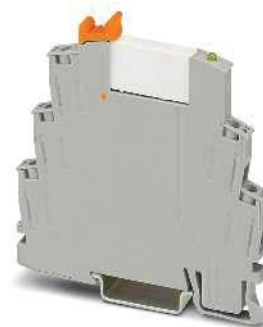

1-changeover-contact relay module with screw connection

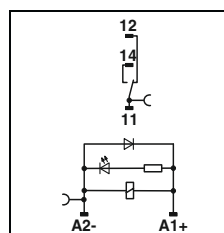

DC coils

Input data	
Permissible range (with reference to U_N)	
Typical input current at U_N	[mA]
Typical response time at U_N	[ms]
Typical release time at U_N	[ms]
Input protection:	
Output data	
Contact type	
Contact material	
Max. switching voltage	
Minimum switching voltage	
Limiting continuous current	
Minimum switching current	
General data	
Test voltage (winding/contact)	
Ambient temperature (operation)	
Nominal operating mode	
Mechanical service life	
Standards/regulations	
Degree of pollution/surge voltage category	
Mounting position/mounting	
Connection data solid/stranded/AWG	
Maximum tightening torque	
Dimensions	W / H / D
EMC note	

Technical data	
①	②
See diagram	
16	9
5	5
8	8
Yellow LED, damping diode	
1 PDT	1 PDT
AgSnO	AgSnO, hard gold-plated
250 V AC/DC	30 V AC / 36 V DC
5 V (at 100 mA)	100 mV (at 10 mA)
6 A	50 mA
10 mA (at 12 V)	1 mA (at 12 V)
4 kV _{rms} (50 Hz, 1 min.)	
-40°C ... 60°C	
100% operating factor	
Approx. 2x 10 ⁷ cycles	
DIN EN 50178	
2 / III	
Any / in rows with zero spacing	
0.5 ... 4 mm ² / 0.5 ... 2.5 mm ² / 20 - 12	
0.6 Nm	
6.2 mm / 84 mm / 82 mm	
Class A product, see page 583	

Description	Input voltage U_N
Coupling relay modules with power contact relay and screw connection	① 12 V DC
	② 24 V DC
Coupling relay modules with multi-layer gold contact relay, with screw connection	① 12 V DC
	② 24 V DC

Ordering data		
Type	Order No.	Pcs./Pkt.
RIF-0-RSC-12DC/21	2903375	10
RIF-0-RSC-24DC/21	2903374	10
RIF-0-RSC-12DC/21AU	2903373	10
RIF-0-RSC-24DC/21AU	2903372	10



1-N/O-contact relay module with screw connection

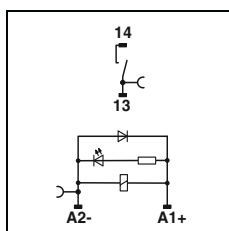

DC coils

Technical data

①	②
See diagram	
16	9
5	5
8	8
Yellow LED, damping diode	

1 N/O contact	1 N/O contact
AgSnO	AgSnO, hard gold-plated
250 V AC/DC	30 V AC / 36 V DC
5 V (at 100 mA)	100 mV (at 10 mA)
6 A	50 mA
10 mA (at 12 V)	1 mA (at 12 V)

4 kV_{rms} (50 Hz, 1 min.)
 -40°C ... 60°C
 100% operating factor
 Approx. 2x 10⁷ cycles
 DIN EN 50178
 2 / III

Any / in rows with zero spacing
 0.5 ... 4 mm² / 0.5 ... 2.5 mm² / 20 - 12
 0.6 Nm
 6.2 mm / 84 mm / 68 mm
 Class A product, see page 583

Ordering data

Type	Order No.	Pcs./Pkt.
RIF-0-RSC-12DC/ 1	2903367	10
RIF-0-RSC-24DC/ 1	2903366	10
RIF-0-RSC-12DC/ 1AU	2903365	10
RIF-0-RSC-24DC/ 1AU	2903364	10

RIF-0-RSC.../21... (1 changeover contact)

Operating voltage range

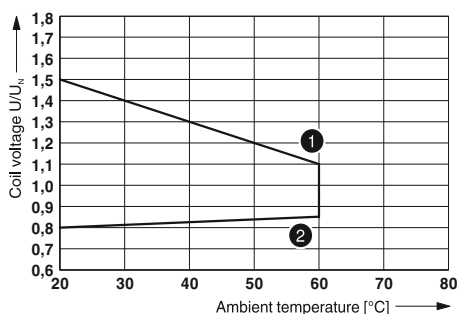

- ① Maximum continuous voltage at limiting continuous current = 6 A
 - ② Minimum operate voltage
- For pre-excitation with U_n and limiting continuous current = 6 A

Interrupting rating

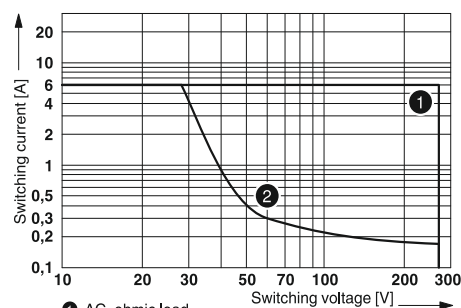

- ① AC, ohmic load
- ② DC, ohmic load

Service life reduction factor with various cos phi

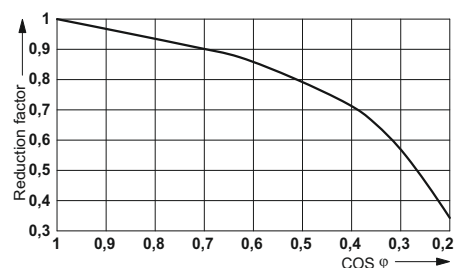

Electrical service life

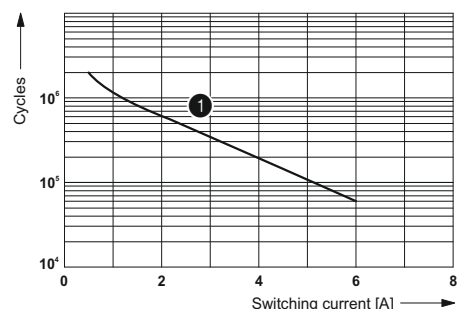

- ① 250 V AC, ohmic load

RIF-0-RSC.../1... (1 N/O contact)

Operating voltage range

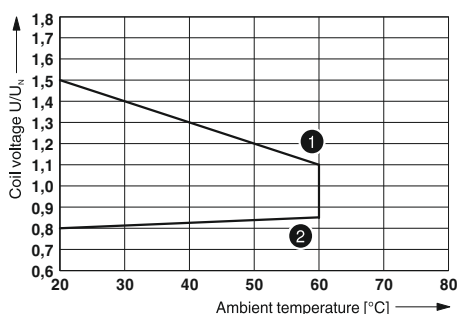

- ① Maximum continuous voltage at limiting continuous current = 6 A
 - ② Minimum operate voltage
- For pre-excitation with U_n and limiting continuous current = 6 A

Interrupting rating

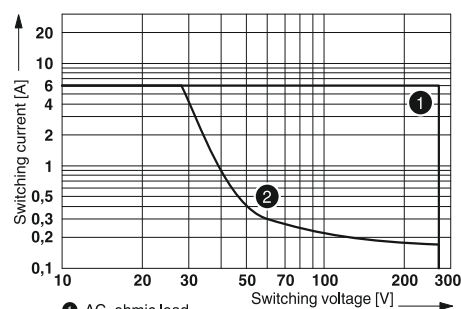

- ① AC, ohmic load
- ② DC, ohmic load

Service life reduction factor

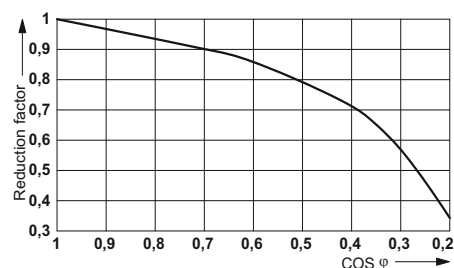

Electrical service life

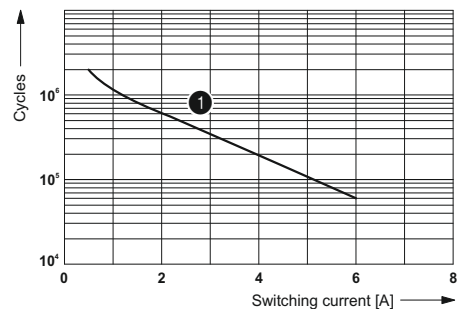

- ① 250 V AC, ohmic load

Relay modules

RIFLINE complete – Industrial relay system

Fully mounted RIF-0 relay modules

Fully mounted RIF-0 relay modules, consisting of:

- Relay base with Push-in connection
- Solid-state relays
- Relay ejector lever on the housing

The advantages:

- Status LED integrated into the base
- RTIII sealed solid-state relay
- Zero voltage switch at AC output
- Professional bridging of adjacent modules saves wiring time

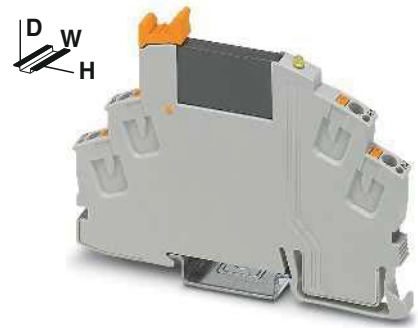

Solid-state relay module with Push-in connection, DC output max. 3 A

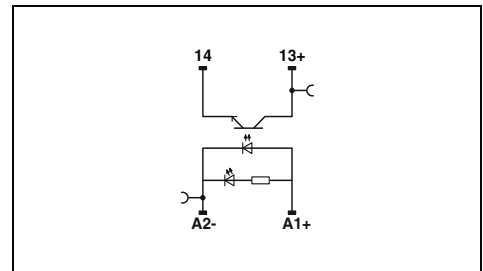

Technical data

Input data	①
Rated actuating voltage range with reference to U_c	0.8 - 1.2
Rated actuating current I_c [mA]	8.5
Switching level (with reference to U_c)	1 signal ("H") >0.8 0 signal ("L") <0.4
Typical switch-on time at U_N [ms]	0.02
Typical switch-off time at U_N [ms]	0.3
Transmission frequency f_{limit} [Hz]	300
Input circuit DC	Yellow LED, free-wheeling diode
Output data	
Max. switching voltage	33 V DC
Minimum switching voltage	3 V DC
Maximum switch-on current	15 A (10 ms)
Minimum/maximum switching current	- / 3 A (see derating curve)
Output protection	Reverse polarity protection, surge protection
Voltage drop at maximum limiting continuous current	<200 mV
Leakage current in off state	-
Phase angle (cos ϕ)	-
Max. load value	-
General data	
Test voltage input/output	2.5 kV _{rms} (50 Hz, 1 min.)
Ambient temperature (operation)	-25°C ... 60°C
Standards/regulations	DIN EN 50178
Degree of pollution/surge voltage category	2 / III
Connection data solid/stranded/AWG	0.14 - 1.5 mm ² / 0.14 - 1.5 mm ² / 24 - 16
Dimensions	W / H / D 6.2 mm / 93 mm / 66 mm
EMC note	Class A product, see page 583

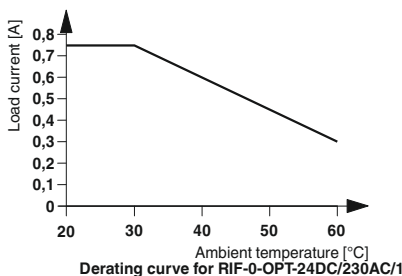
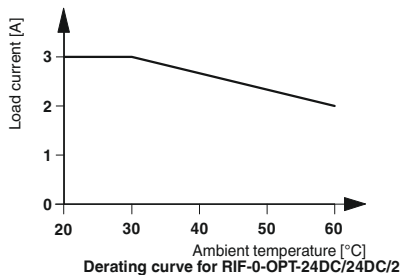

Description		Rated actuating voltage U_c	Ordering data	
Type	Order No.	Pcs./Pkt.		
Coupling relay modules with solid-state relay and Push-in connection				
①	24 V DC	RIF-0-OPT-24DC/24DC/2	2905293	10

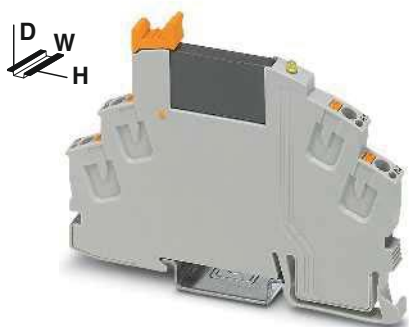

Solid-state relay module with Push-in connection, DC output max. 100 mA

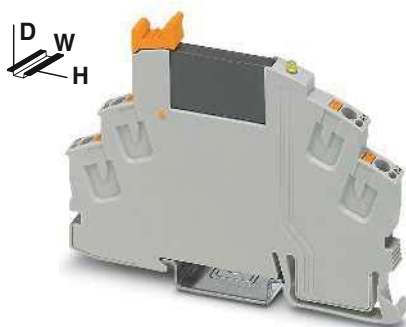

Solid-state relay module with Push-in connection, AC output max. 750 mA

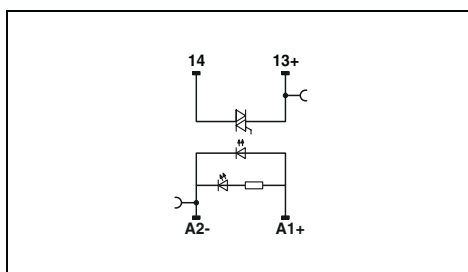
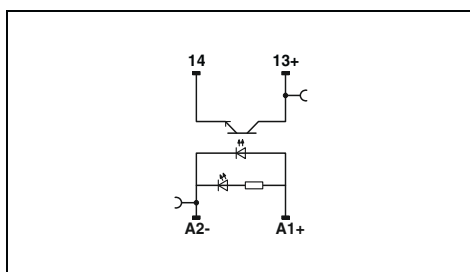

Technical data

①
0.8 - 1.2
8.5
>0.8
<0.4
0.02
0.3
300
Yellow LED, free-wheeling diode
48 V DC
3 V DC
-
- / 100 mA
Reverse polarity protection, surge protection
<1 V
-
-
-
2.5 kV _{rms} (50 Hz, 1 min.)
-25°C ... 60°C
DIN EN 50178
2 / III
0.14 - 1.5 mm ² / 0.14 - 1.5 mm ² / 24 - 16
6.2 mm / 93 mm / 66 mm
Class A product, see page 583

Technical data

①
0.8 - 1.2
8
>0.8
<0.4
10
10
10
Yellow LED, free-wheeling diode
253 V AC
24 V AC
30 A (10 ms)
10 mA / 0.75 A (see derating curve)
RCV circuit
<1 V
1 mA (in off state)
0.5
4.5 A ² s (tp = 10 ms, at 25°C)
2.5 kV _{rms} (50 Hz, 1 min.)
-25°C ... 60°C
DIN EN 50178
2 / III
0.14 - 1.5 mm ² / 0.14 - 1.5 mm ² / 24 - 16
6.2 mm / 93 mm / 66 mm
Class A product, see page 583

Ordering data

Type	Order No.	Pcs./Pkt.
RIF-0-OPT-24DC/48DC/100	2905294	10

Ordering data

Type	Order No.	Pcs./Pkt.
RIF-0-OPT-24DC/230AC/1	2905295	10

Relay modules

RIFLINE complete – Industrial relay system

Fully mounted RIF-0 relay modules

Fully mounted RIF-0 relay modules, consisting of:

- Relay base with screw connection
- Solid-state relays
- Relay ejector lever on the housing

The advantages:

- Status LED integrated into the base
- RTIII sealed solid-state relay
- Zero voltage switch at AC output
- Professional bridging of adjacent modules saves wiring time

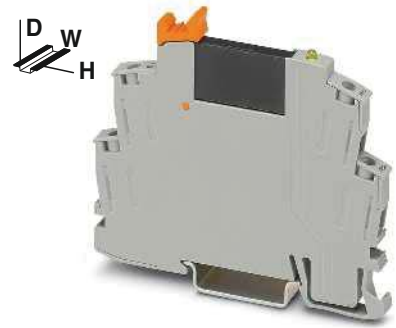

Solid-state relay module with screw connection, DC output max. 3 A

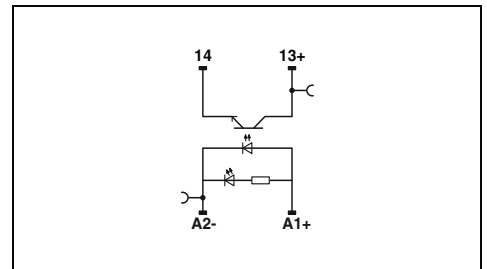

Technical data

Input data	①
Rated actuating voltage range with reference to U_c	0.8 - 1.2
Rated actuating current I_c [mA]	8.5
Switching level (with reference to U_c)	1 signal ("H") >0.8 0 signal ("L") <0.4
Typical switch-on time at U_N [ms]	0.02
Typical switch-off time at U_N [ms]	0.3
Transmission frequency f_{limit} [Hz]	300
Input circuit DC	Yellow LED, free-wheeling diode
Output data	
Max. switching voltage	33 V DC
Minimum switching voltage	3 V DC
Maximum switch-on current	15 A (10 ms)
Minimum/maximum switching current	- / 3 A (see derating curve)
Output protection	Reverse polarity protection, surge protection
Voltage drop at maximum limiting continuous current	<200 mV
Leakage current in off state	-
Phase angle (cos ϕ)	-
Max. load value	-
General data	
Test voltage input/output	2.5 kV _{rms} (50 Hz, 1 min.)
Ambient temperature (operation)	-25°C ... 60°C
Standards/regulations	DIN EN 50178
Degree of pollution/surge voltage category	2 / III
Connection data solid/stranded/AWG	0.5 - 4 mm ² / 0.5 - 2.5 mm ² / 20 - 12
Maximum tightening torque	0.6 Nm
Dimensions	6.2 mm / 84 mm / 68 mm
EMC note	Class A product, see page 583

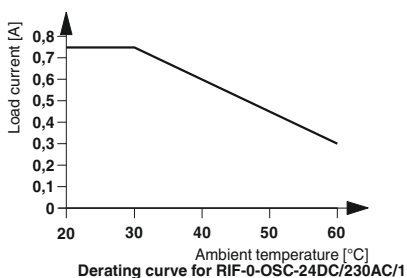
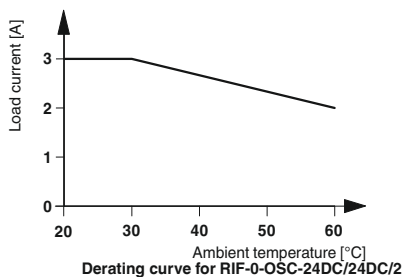

Description		Rated actuating voltage U_c	
Coupling relay modules with solid-state relay and screw connection		①	24 V DC
Type	Order No.	Pcs./Pkt.	
RIF-0-OSC-24DC/24DC/2	2905657	10	

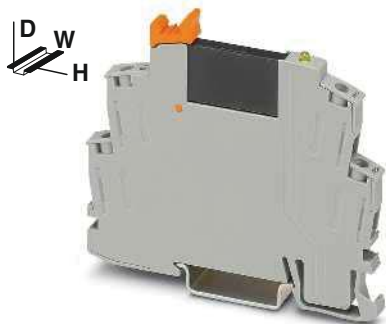

Solid-state relay module with screw connection, DC output max. 100 mA

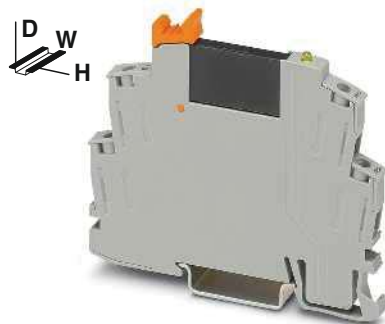

Solid-state relay module with screw connection, AC output max. 750 mA

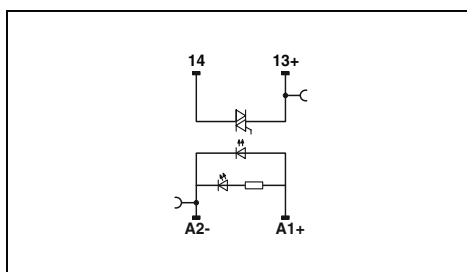
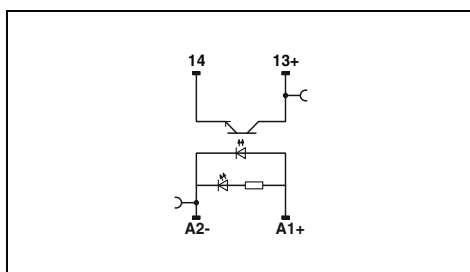

Technical data

①
0.8 - 1.2
8.5
>0.8
<0.4
0.02
0.3
300
Yellow LED, free-wheeling diode
48 V DC
3 V DC
-
- / 100 mA
Reverse polarity protection, surge protection
<1 V
-
-
-
2.5 kV _{rms} (50 Hz, 1 min.)
-25°C ... 60°C
DIN EN 50178
2 / III
0.5 - 4 mm ² / 0.5 - 2.5 mm ² / 20 - 12
0.6 Nm
6.2 mm / 84 mm / 68 mm
Class A product, see page 583

Technical data

①
0.8 - 1.2
8
>0.8
<0.4
10
10
10
Yellow LED, free-wheeling diode
253 V AC
24 V AC
30 A (10 ms)
10 mA / 0.75 A (see derating curve)
RCV circuit
<1 V
1 mA (in off state)
0.5
4.5 A ² s (tp = 10 ms, at 25°C)
2.5 kV _{rms} (50 Hz, 1 min.)
-25°C ... 60°C
DIN EN 50178
2 / III
0.5 - 4 mm ² / 0.5 - 2.5 mm ² / 20 - 12
0.6 Nm
6.2 mm / 84 mm / 68 mm
Class A product, see page 583

Ordering data

Type	Order No.	Pcs./Pkt.
RIF-0-OSC-24DC/48DC/100	2905658	10

Ordering data

Type	Order No.	Pcs./Pkt.
RIF-0-OSC-24DC/230AC/1	2905656	10

Fully mounted RIF-1 relay modules

Fully mounted RIF-1 relay modules, consisting of:

- Relay base with Push-in connection
- 1 or 2 PDT relays
- Relay retaining bracket
- Interference suppression module

The advantages:

- Logical contact arrangement, thanks to 1/3-level relay base
- Operational reliability, thanks to sealed relay
- Safe isolation between coil and contact side
- Professional bridging of adjacent modules saves wiring time
- For FBS 2-6 plug-in bridges for the input side (A2), see page 358
- For FBS 2-8 plug-in bridges for the output side (11/21), see page 358

Notes:

If the specified maximum values for multi-layer contact relays are exceeded, the gold plating is destroyed. The maximum values of the power contact relay are then valid. This can result in a shorter service life than with a pure power contact.



1-changeover-contact relay module with Push-in connection

ERIC

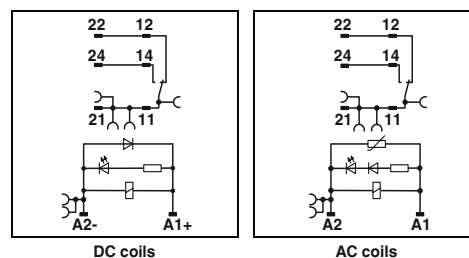

		Technical data				
		①	②	③	④	⑤
Input data		See diagram				
Permissible range (with reference to U_N)		33	18	33	8	6
Typical input current at U_N	[mA]	8	8	3 - 12	3 - 12	3 - 12
Typical response time at U_N	[ms]	10	10	3 - 20	3 - 20	3 - 20
Typical release time at U_N	[ms]	Yellow LED, Varistor				
Input circuit AC		Yellow LED, damping diode				
Input circuit DC						
Output data		1 PDT		1 PDT		
Contact type		AgNi		AgNi, hard gold-plated		
Contact material		250 V AC/DC		30 V AC / 36 V DC		
Max. switching voltage		12 V (at 10 mA)		100 mV (at 10 mA)		
Minimum switching voltage		11 A (see diagram)		50 mA		
Limiting continuous current		25 A (20 ms, N/O contact)		50 mA		
Maximum switch-on current AC		50 A (20 ms, N/O contact)		50 mA		
Maximum switch-on current DC		10 mA (at 12 V)		1 mA (at 24 V)		
Minimum switching current						
General data		4 kV _{rms} (50 Hz, 1 min.)				
Test voltage (winding/contact)		-40°C ... 50°C				
Ambient temperature (operation), AC		-40°C ... 70°C				
Ambient temperature (operation), DC		100% operating factor				
Nominal operating mode		Approx. 10 ⁷ cycles				
Mechanical service life, AC		Approx. 3x 10 ⁷ cycles				
Mechanical service life, DC		DIN EN 50178				
Standards/regulations		2 / III				
Degree of pollution/surge voltage category						
Mounting position/mounting		Any / in rows with zero spacing				
Connection data solid/stranded/AWG		0.14 ... 1.5 mm ² / 0.14 ... 1.5 mm ² / 26 - 16				
Dimensions	W / H / D	16 mm / 93 mm / 75 mm				
EMC note		Class A product, see page 583				

		Ordering data		
Description	Input voltage U_N	Type	Order No.	Pcs./Pkt.
Coupling relay modules with power contact relay and Push-in connection				
	① 12 V DC	RIF-1-RPT-LDP-12DC/1X21	2906224	10
	② 24 V DC	RIF-1-RPT-LDP-24DC/1X21	2903342	10
	③ 24 V AC	RIF-1-RPT-LV-24AC/1X21	2903341	10
	④ 120 V AC	RIF-1-RPT-LV-120AC/1X21	2903340	10
	⑤ 230 V AC	RIF-1-RPT-LV-230AC/1X21	2903339	10
Coupling relay modules with multi-layer gold contact relay, with Push-in connection				
	① 24 V DC	RIF-1-RPT-LDP-24DC/1X21AU	2903338	10
	② 24 V AC	RIF-1-RPT-LV-24AC/1X21AU	2903337	10
	③ 120 V AC	RIF-1-RPT-LV-120AC/1X21AU	2903336	10
	④ 230 V AC	RIF-1-RPT-LV-230AC/1X21AU	2903335	10



2-changeover-contact relay module with Push-in connection

ERC

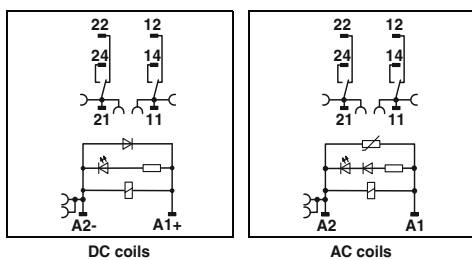

Technical data

①	②	③	④	⑤
See diagram				
33	18	33	8	6
8	8	3 - 12	3 - 12	3 - 12
10	10	3 - 20	3 - 20	3 - 20
Yellow LED, Varistor				
Yellow LED, damping diode				

2 PDT	2 PDT
AgNi	AgNi, hard gold-plated
250 V AC/DC	30 V AC / 36 V DC
5 V (at 10 mA)	100 mV (at 10 mA)
8 A (see diagram)	50 mA
12 A (20 ms, N/O contact)	50 mA
25 A (20 ms, N/O contact)	50 mA
10 mA (at 5 V)	1 mA (at 24 V)

4 kV_{rms} (50 Hz, 1 min.)
 -40°C ... 50°C
 -40°C ... 70°C
 100% operating factor
 Approx. 10⁷ cycles
 Approx. 3x 10⁷ cycles
 DIN EN 50178
 2 / III

Any / in rows with zero spacing
 0.14 ... 1.5 mm² / 0.14 ... 1.5 mm² / 26 - 16
 16 mm / 93 mm / 75 mm
 Class A product, see page 583

Ordering data

Type	Order No.	Pcs./Pkt.
RIF-1-RPT-LDP-12DC/2X21	2906223	10
RIF-1-RPT-LDP-24DC/2X21	2903334	10
RIF-1-RPT-LV-24AC/2X21	2903333	10
RIF-1-RPT-LV-120AC/2X21	2903332	10
RIF-1-RPT-LV-230AC/2X21	2903331	10
RIF-1-RPT-LDP-24DC/2X21AU	2903330	10
RIF-1-RPT-LV-24AC/2X21AU	2903329	10
RIF-1-RPT-LV-120AC/2X21AU	2903328	10
RIF-1-RPT-LV-230AC/2X21AU	2903327	10

RIF-1-RPT.../1X21... (1 changeover contact)

Operating voltage range

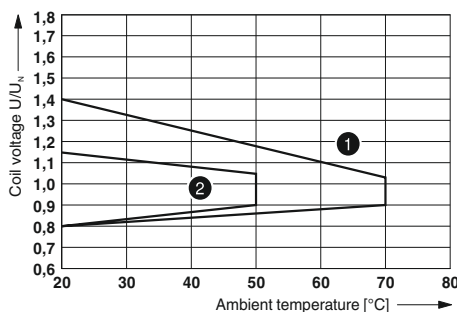

- ① DC coils
- ② AC coils

Contact derating

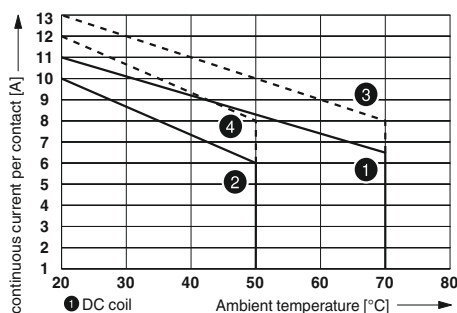

- ① DC coil
- ② AC coil
- ③ DC coil, jumper between 11 and 21
- ④ AC coil, jumper between 11 and 21

Interrupting rating

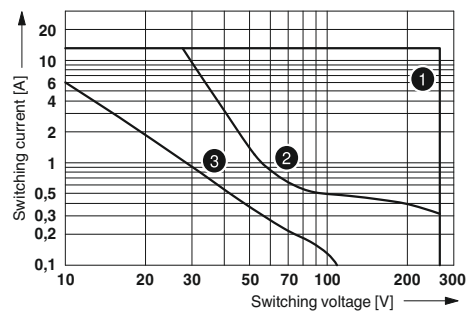

- ① AC, ohmic load
- ② DC, ohmic load
- ③ DC, L/R = 40 ms

Electrical service life

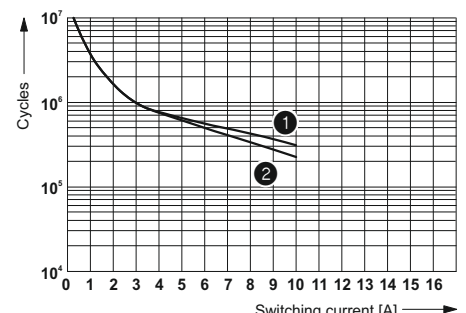

- ① 250 V AC, ohmic load (DC coils)
- ② 250 V AC, ohmic load (AC coils)

RIF-1-RPT.../2X21... (2 changeover contacts)

Operating voltage range

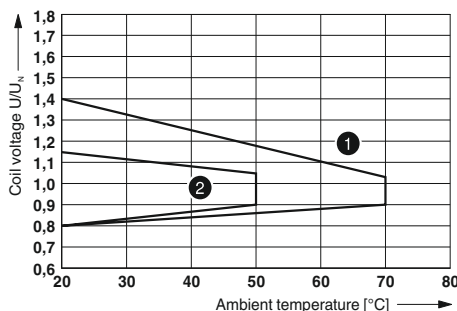

- ① DC coils
- ② AC coils

Contact derating

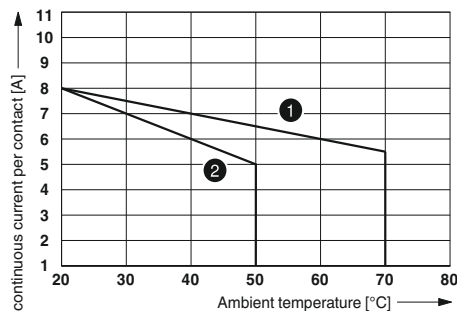

- ① DC coil
- ② AC coil

Interrupting rating

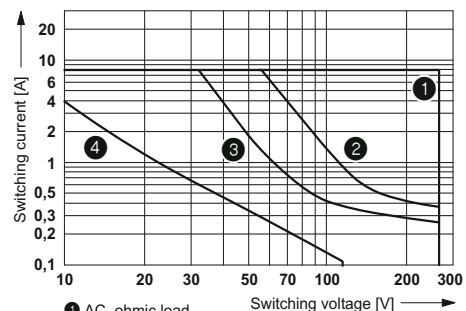

- ① AC, ohmic load
- ② DC, ohmic load, contacts in series
- ③ DC, ohmic load
- ④ DC, L/R = 40 ms

Electrical service life

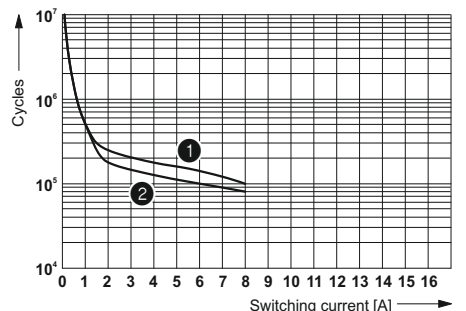

- ① 250 V AC, ohmic load (DC coils)
- ② 250 V AC, ohmic load (AC coils)

Fully mounted RIF-1 relay modules

Fully mounted RIF-1 relay modules, consisting of:

- Relay base with screw connection
- 1 or 2 PDT relays
- Relay retaining bracket
- Interference suppression module

The advantages:

- Logical contact arrangement, thanks to 1/3-level relay base
- Operational reliability, thanks to sealed relay
- Safe isolation between coil and contact side
- Professional bridging of adjacent modules saves wiring time
- For FBS 2-6 plug-in bridges for the input side (A2), see page 358
- For FBS 2-8 plug-in bridges for the output side (11/21), see page 358

Notes:

If the specified maximum values for multi-layer contact relays are exceeded, the gold plating is destroyed. The maximum values of the power contact relay are then valid. This can result in a shorter service life than with a pure power contact.

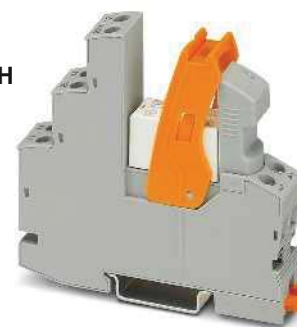

1-changeover-contact relay module with screw connection

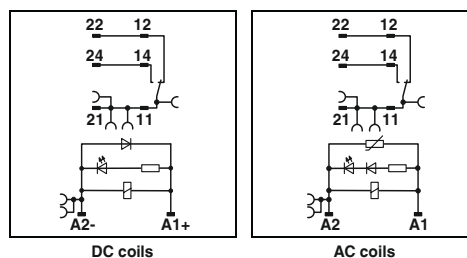

		Technical data				
		①	②	③	④	⑤
Input data		See diagram				
Permissible range (with reference to U_N)		33	18	33	8	6
Typical input current at U_N	[mA]	8	8	3 - 12	3 - 12	3 - 12
Typical response time at U_N	[ms]	10	10	3 - 20	3 - 20	3 - 20
Typical release time at U_N	[ms]	Yellow LED, Varistor				
Input circuit AC		Yellow LED, damping diode				
Input circuit DC						
Output data		1 PDT		1 PDT		
Contact type		AgNi		AgNi, hard gold-plated		
Contact material		250 V AC/DC		30 V AC / 36 V DC		
Max. switching voltage		12 V (at 10 mA)		100 mV (at 10 mA)		
Minimum switching voltage		11 A (see diagram)		50 mA		
Limiting continuous current		25 A (20 ms, N/O contact)		25 A (20 ms, N/O contact)		
Maximum switch-on current AC		50 A (20 ms, N/O contact)		50 mA		
Maximum switch-on current DC		10 mA (at 12 V)		1 mA (at 24 V)		
Minimum switching current						
General data		4 kV _{rms} (50 Hz, 1 min.)				
Test voltage (winding/contact)		-40°C ... 50°C				
Ambient temperature (operation), AC		-40°C ... 70°C				
Ambient temperature (operation), DC		100% operating factor				
Nominal operating mode		Approx. 10 ⁷ cycles				
Mechanical service life, AC		Approx. 3x 10 ⁷ cycles				
Mechanical service life, DC		DIN EN 50178				
Standards/regulations		2 / III				
Degree of pollution/surge voltage category						
Mounting position/mounting		Any / in rows with zero spacing				
Connection data solid/stranded/AWG		0.5 ... 4 mm ² / 0.5 ... 4 mm ² / 20 - 10				
Dimensions	W / H / D	16 mm / 89 mm / 75 mm				
EMC note		Class A product, see page 583				

		Ordering data		
Description	Input voltage U_N	Type	Order No.	Pcs./Pkt.
Coupling relay modules with power contact relay and screw connection				
	① 12 V DC	RIF-1-RSC-LDP-12DC/1X21	2908500	10
	② 24 V DC	RIF-1-RSC-LDP-24DC/1X21	2903358	10
	③ 24 V AC	RIF-1-RSC-LV-24AC/1X21	2903357	10
	④ 120 V AC	RIF-1-RSC-LV-120AC/1X21	2903356	10
	⑤ 230 V AC	RIF-1-RSC-LV-230AC/1X21	2903355	10
Coupling relay modules with multi-layer gold contact relay, with screw connection				
	① 24 V DC	RIF-1-RSC-LDP-24DC/1X21AU	2903354	10
	② 24 V AC	RIF-1-RSC-LV-24AC/1X21AU	2903353	10
	③ 120 V AC	RIF-1-RSC-LV-120AC/1X21AU	2903352	10
	④ 230 V AC	RIF-1-RSC-LV-230AC/1X21AU	2903351	10

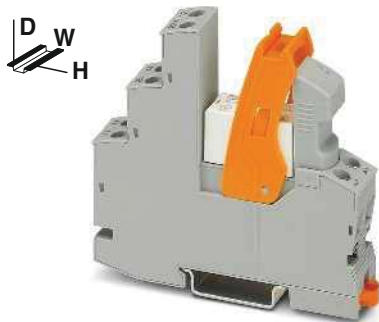

2-changeover-contact relay module with screw connection

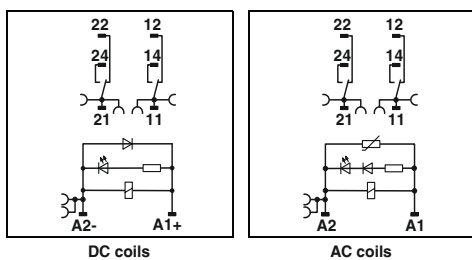

Technical data

①	②	③	④	⑤
See diagram				
33	18	33	8	6
8	8	3-12	3-12	3-12
10	10	3-20	3-20	3-20
Yellow LED, Varistor				
Yellow LED, damping diode				

2 PDT	2 PDT
AgNi	AgNi, hard gold-plated
250 V AC/DC	30 V AC / 36 V DC
5 V (at 10 mA)	100 mV (at 10 mA)
8 A (see diagram)	50 mA
12 A (20 ms, N/O contact)	50 mA
25 A (20 ms, N/O contact)	50 mA
10 mA (at 5 V)	1 mA (at 24 V)

4 kV_{rms} (50 Hz, 1 min.)
 -40°C ... 50°C
 -40°C ... 70°C
 100% operating factor
 Approx. 10⁷ cycles
 Approx. 3x 10⁷ cycles
 DIN EN 50178
 2 / III

Any / in rows with zero spacing
 0.5 ... 4 mm² / 0.5 ... 4 mm² / 20 - 10
 16 mm / 89 mm / 75 mm
 Class A product, see page 583

Ordering data

Type	Order No.	Pcs./Pkt.
RIF-1-RSC-LDP-12DC/2X21	2908501	10
RIF-1-RSC-LDP-24DC/2X21	2903350	10
RIF-1-RSC-LV-24AC/2X21	2903349	10
RIF-1-RSC-LV-120AC/2X21	2903348	10
RIF-1-RSC-LV-230AC/2X21	2903347	10
RIF-1-RSC-LDP-24DC/2X21AU	2903346	10
RIF-1-RSC-LV-24AC/2X21AU	2903345	10
RIF-1-RSC-LV-120AC/2X21AU	2903344	10
RIF-1-RSC-LV-230AC/2X21AU	2903343	10

RIF-1-RSC.../1X21... (1 changeover contact)

Operating voltage range

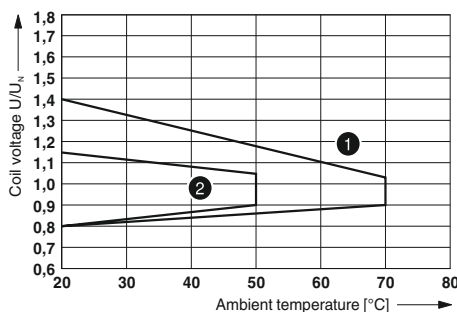

- ① DC coils
- ② AC coils

Contact derating

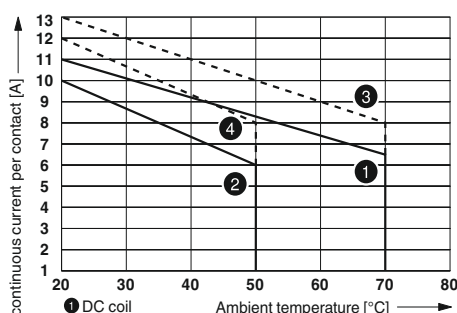

- ① DC coil
- ② AC coil
- ③ DC coil, jumper between 11 and 21
- ④ AC coil, jumper between 11 and 21

Interrupting rating

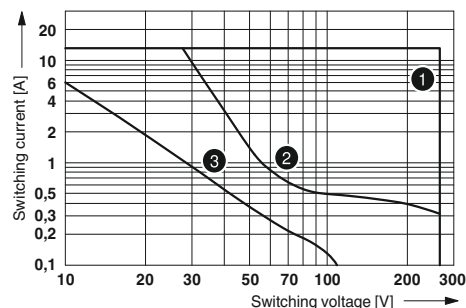

- ① AC, ohmic load
- ② DC, ohmic load
- ③ DC, L/R = 40 ms

Electrical service life

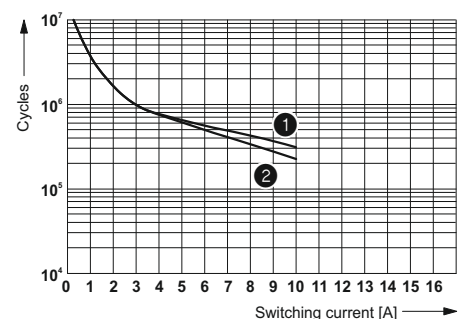

- ① 250 V AC, ohmic load (DC coils)
- ② 250 V AC, ohmic load (AC coils)

RIF-1-RSC.../2X21... (2 changeover contacts)

Operating voltage range

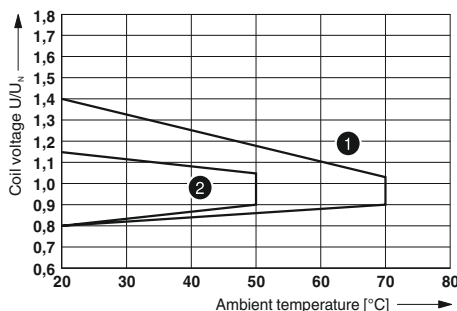

- ① DC coils
- ② AC coils

Contact derating

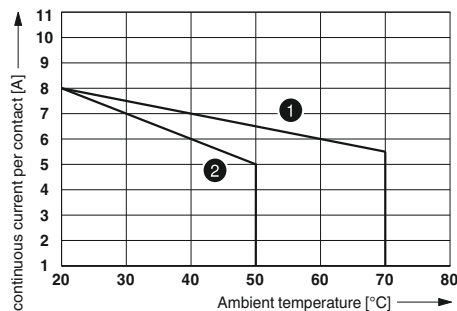

- ① DC coil
- ② AC coil

Interrupting rating

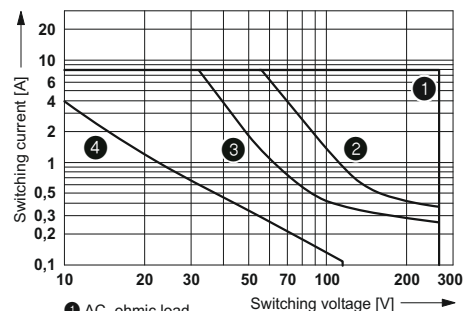

- ① AC, ohmic load
- ② DC, ohmic load, contacts in series
- ③ DC, ohmic load
- ④ DC, L/R = 40 ms

Electrical service life

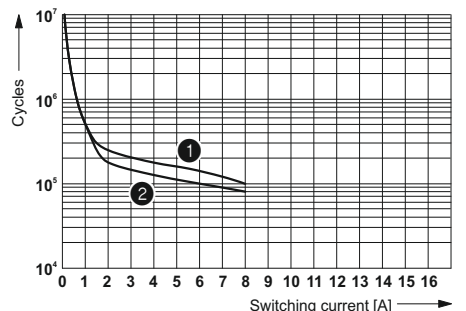

- ① 250 V AC, ohmic load (DC coils)
- ② 250 V AC, ohmic load (AC coils)

Fully mounted RIF-1 relay modules

Fully mounted RIF-1 relay modules, consisting of:

- Relay base with Push-in connection
- 1 or 2 PDT relays with detectable manual operation
- Relay retaining bracket
- Interference suppression module (AC types only)

The advantages:

- Relay with lockable manual operation and status LED
- With DC types, free-wheeling diode is integrated into relay
- Mechanical switch position indicator
- Professional bridging of adjacent modules saves wiring time



1-changeover-contact relay module with Push-in connection and manual operation

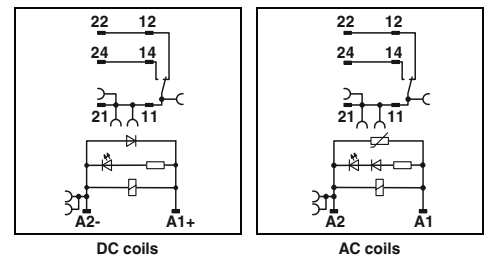

Input data		①	②	③
Permissible range (with reference to U_N)		See diagram		
Typical input current at U_N	[mA]	18	7	3.5
Typical response time at U_N	[ms]	9	4 - 10	4 - 10
Typical release time at U_N	[ms]	10	3 - 20	3 - 20
Input circuit AC		Yellow LED, Varistor		
Input circuit DC		Yellow LED, damping diode		
Output data				
Contact type		1 PDT		
Contact material		AgNi		
Max. switching voltage		250 V AC/DC		
Minimum switching voltage		12 V (at 10 mA)		
Limiting continuous current		See diagram		
Maximum switch-on current AC		32 A (20 ms, N/O contact)		
Maximum switch-on current DC		24 A (20 ms, N/O contact)		
Minimum switching current		10 mA (at 12 V)		
General data				
Test voltage (winding/contact)		4 kV _{rms} (50 Hz, 1 min.)		
Ambient temperature (operation), AC		-40°C ... 50°C		
Ambient temperature (operation), DC		-40°C ... 60°C		
Nominal operating mode		100% operating factor		
Mechanical service life		Approx. 5x 10 ⁶ cycles		
Standards/regulations		DIN EN 50178		
Degree of pollution/surge voltage category		2 / III		
Mounting position/mounting		Any / in rows with zero spacing		
Connection data solid/stranded/AWG		0.14 ... 1.5 mm ² / 0.14 ... 1.5 mm ² / 26 - 16		
Dimensions	W / H / D	16 mm / 93 mm / 75 mm		
EMC note		Class A product, see page 583		

Description		Input voltage U_N	Ordering data	
Type	Order No.	Pcs./Pkt.		
Coupling relay modules with power contact relay with manual operation and Push-in connection				
①	24 V DC	RIF-1-RPT-LDP-24DC/1X21MS	2905289	10
②	120 V AC	RIF-1-RPT-LV-120AC/1X21MS	2909776	10
③	230 V AC	RIF-1-RPT-LV-230AC/1X21MS	2905290	10



2-changeover-contact relay module with Push-in connection and manual operation

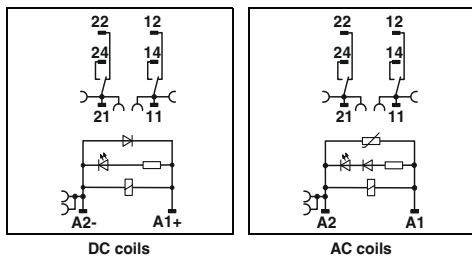

Technical data

①	②	③
See diagram		
18	7	3.5
9	4 - 10	4 - 10
10	3 - 20	3 - 20
Yellow LED, Varistor		
Yellow LED, damping diode		

2 PDT
 AgNi
 250 V AC/DC
 12 V (at 10 mA)
 See diagram
 16 A (20 ms, N/O contact)
 12 A (20 ms, N/O contact)
 10 mA (at 12 V)

4 kV_{rms} (50 Hz, 1 min.)
 -40°C ... 45°C
 -40°C ... 60°C
 100% operating factor
 Approx. 5x 10⁶ cycles
 DIN EN 50178
 2 / III

Any / in rows with zero spacing
 0.14 ... 1.5 mm² / 0.14 ... 1.5 mm² / 26 - 16
 16 mm / 93 mm / 75 mm
 Class A product, see page 583

Ordering data

Type	Order No.	Pcs./Pkt.
RIF-1-RPT-LDP-24DC/2X21MS	2905291	10
RIF-1-RPT-LV-120AC/2X21MS	2909775	10
RIF-1-RPT-LV-230AC/2X21MS	2905292	10

RIF-1-RPT.../1X21... (1 changeover contact)

Operating voltage range

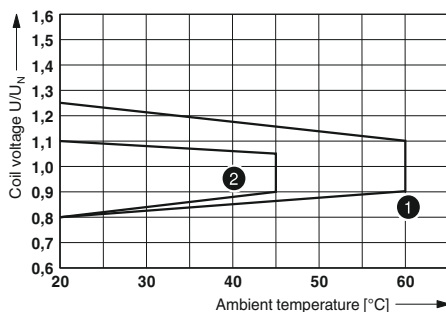

- ① DC coils
- ② AC coils

Interrupting rating

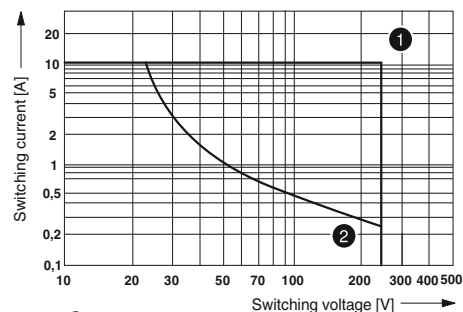

- ① AC, ohmic load
- ② DC, ohmic load

Contact derating

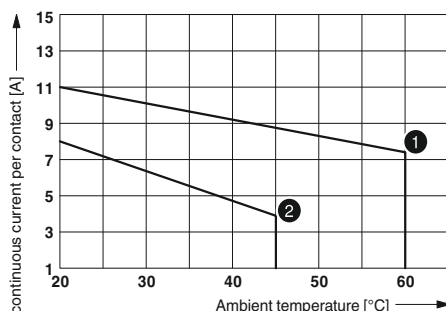

- ① DC coil
- ② AC coil

Electrical service life

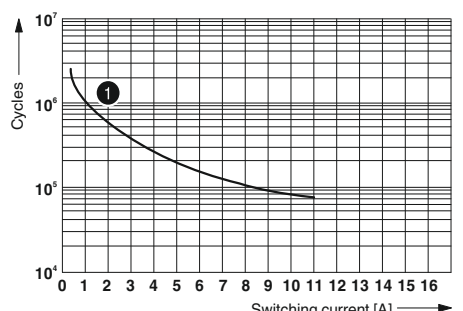

- ① = 250 V AC, ohmic load

RIF-1-RPT.../2X21... (2 changeover contacts)

Operating voltage range

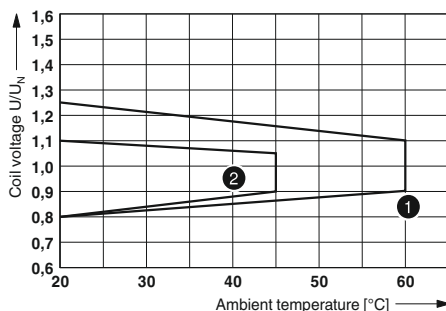

- ① DC coils
- ② AC coils

Interrupting rating

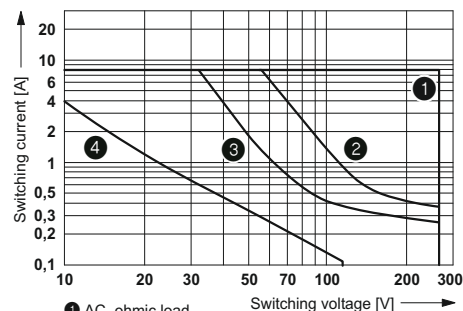

- ① AC, ohmic load
- ② DC, ohmic load, contacts in series
- ③ DC, ohmic load
- ④ DC, L/R = 40 ms

Contact derating

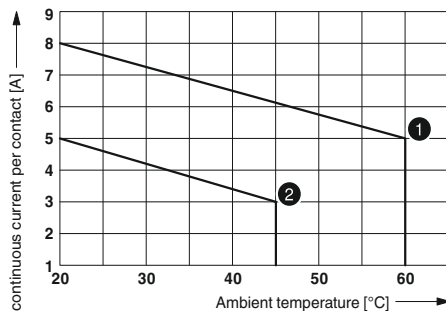

- ① DC coil
- ② AC coil

Electrical service life

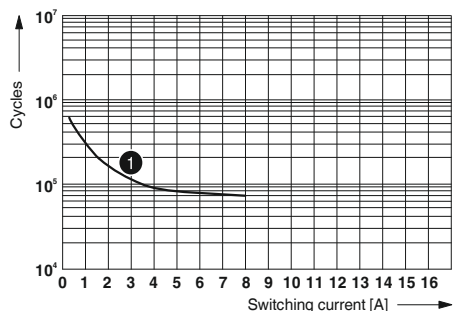

- ① 250 V AC, ohmic load

Fully mounted RIF-1 relay modules

Fully mounted RIF-1 relay modules, consisting of:

- Relay base with screw connection
- 1 or 2 PDT relays with detectable manual operation
- Relay retaining bracket
- Interference suppression module (AC types only)

The advantages:

- Relay with lockable manual operation and status LED
- With DC types, free-wheeling diode is integrated into relay
- Mechanical switch position indicator
- Professional bridging of adjacent modules saves wiring time

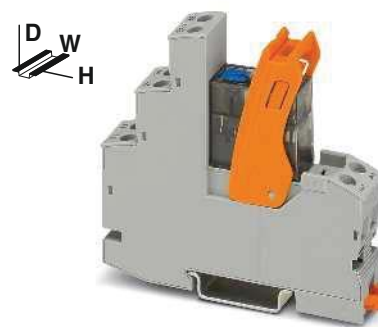

1-changeover-contact relay module with screw connection and manual operation

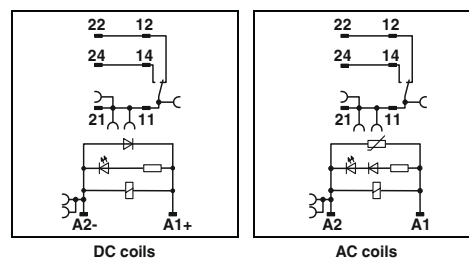

Input data		Technical data		
Permissible range (with reference to U_N)		①	②	③
Typical input current at U_N	[mA]	See diagram		
Typical response time at U_N	[ms]	18	7	4.5
Typical release time at U_N	[ms]	9	4 - 10	4 - 12
Input circuit AC		10	3 - 20	4 - 20
Input circuit DC		Yellow LED, Varistor		
Output data		Yellow LED, damping diode		
Contact type		1 PDT		
Contact material		AgNi		
Max. switching voltage		250 V AC/DC		
Minimum switching voltage		12 V (at 10 mA)		
Limiting continuous current		See diagram		
Maximum switch-on current AC		32 A (20 ms, N/O contact)		
Maximum switch-on current DC		24 A (20 ms, N/O contact)		
Minimum switching current		10 mA (at 12 V)		
General data				
Test voltage (winding/contact)		4 kV _{rms} (50 Hz, 1 min.)		
Ambient temperature (operation), AC		-40°C ... 50°C		
Ambient temperature (operation), DC		-40°C ... 60°C		
Nominal operating mode		100% operating factor		
Mechanical service life		Approx. 5x 10 ⁶ cycles		
Standards/regulations		DIN EN 50178		
Degree of pollution/surge voltage category		2 / III		
Mounting position/mounting		Any / in rows with zero spacing		
Connection data solid/stranded/AWG		0.5 ... 4 mm ² / 0.5 ... 4 mm ² / 20 - 10		
Dimensions	W / H / D	16 mm / 89 mm / 75 mm		
EMC note		Class A product, see page 583		

Description		Ordering data		
Description	Input voltage U_N	Type	Order No.	Pcs./Pkt.
Coupling relay modules with power contact relay with manual operation and screw connection				
	① 24 V DC	RIF-1-RSC-LDP-24DC/1X21MS	2905659	10
	② 120 V AC	RIF-1-RSC-LV-120AC/1X21MS	2909774	10
	③ 230 V AC	RIF-1-RSC-LV-230AC/1X21MS	2905661	10

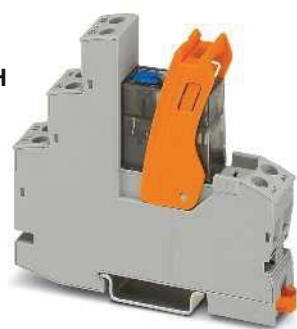

2-changeover-contact relay module with screw connection and manual operation

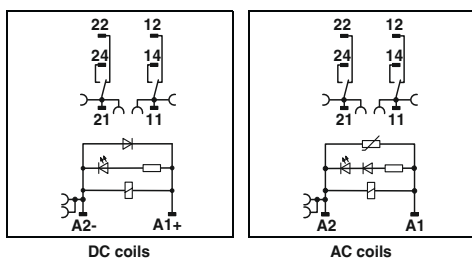

Technical data

①	②	③
See diagram		
18	7	4.5
9	4 - 10	4 - 12
10	3 - 20	4 - 20
Yellow LED, Varistor		
Yellow LED, damping diode		

2 PDT
AgNi
250 V AC/DC
12 V (at 10 mA)
See diagram
16 A (20 ms, N/O contact)
12 A (20 ms, N/O contact)
10 mA (at 12 V)

4 kV_{rms} (50 Hz, 1 min.)
-40°C ... 45°C
-40°C ... 60°C
100% operating factor
Approx. 5x 10⁶ cycles
DIN EN 50178
2 / III

Any / in rows with zero spacing
0.5 ... 4 mm² / 0.5 ... 4 mm² / 20 - 10
16 mm / 89 mm / 75 mm
Class A product, see page 583

Ordering data

Type	Order No.	Pcs./Pkt.
RIF-1-RSC-LDP-24DC/2X21MS	2905660	10
RIF-1-RSC-LV-120AC/2X21MS	2909773	10
RIF-1-RSC-LV-230AC/2X21MS	2905662	10

RIF-1-RSC.../1X21... (1 changeover contact)

Operating voltage range

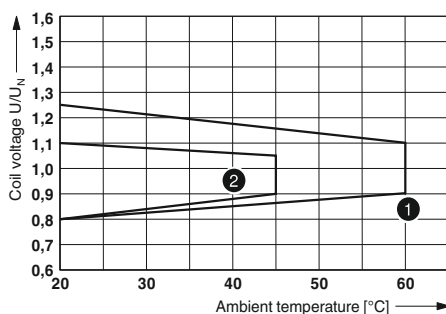

- ① DC coils
- ② AC coils

Contact derating

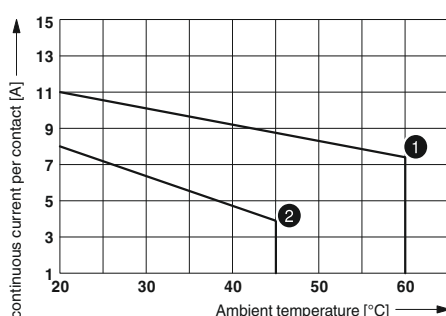

- ① DC coil
- ② AC coil

Interrupting rating

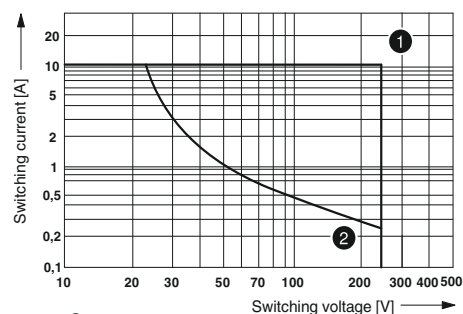

- ① AC, ohmic load
- ② DC, ohmic load

Electrical service life

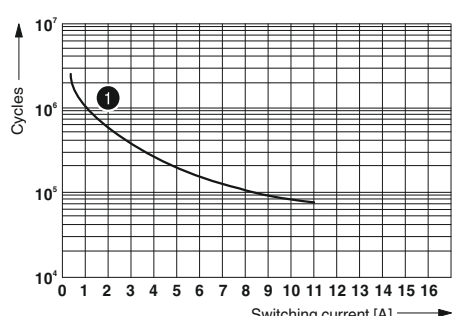

- ① = 250 V AC, ohmic load

RIF-1-RSC.../2X21... (2 changeover contacts)

Operating voltage range

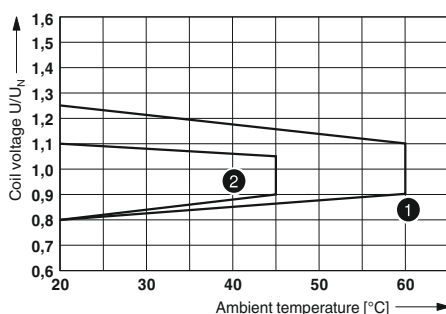

- ① DC coils
- ② AC coils

Contact derating

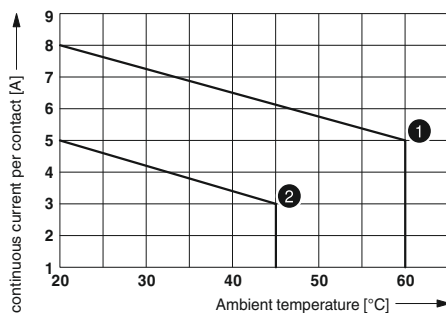

- ① DC coil
- ② AC coil

Interrupting rating

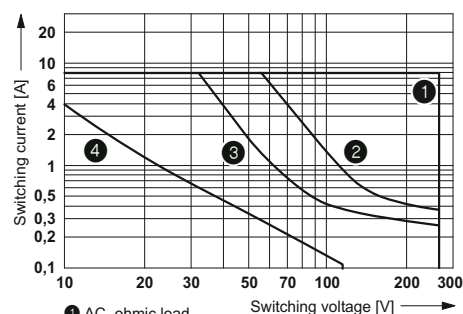

- ① AC, ohmic load
- ② DC, ohmic load, contacts in series
- ③ DC, ohmic load
- ④ DC, L/R = 40 ms

Electrical service life

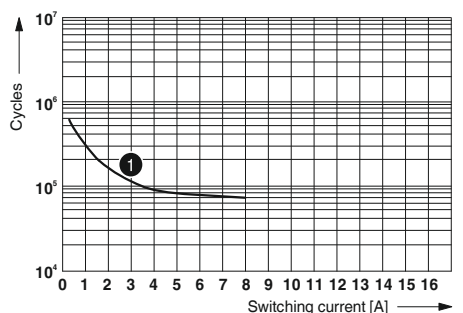

- ① 250 V AC, ohmic load

Relay modules

RIFLINE complete – Industrial relay system

Fully mounted relays for high inrush currents, e.g., LEDs

Fully mounted RIF-1 relay modules, consisting of:

- Relay base with Push-in connection
- 1-N/O-contact relay
- Relay retaining bracket

The advantages:

- Maximum inrush current up to 130 A
- Logical contact arrangement, thanks to 1/3-level relay base
- Operational reliability, thanks to sealed relay
- Safe isolation between coil and contact side
- Professional bridging of adjacent modules saves wiring time
- For FBS 2-6 plug-in bridges for the input side (A2), see page 358
- For FBS 2-8 plug-in bridges for the output side (11/21), see page 358

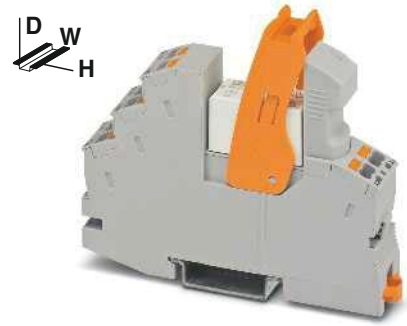

1-N/O-contact relay module with Push-in and screw connection

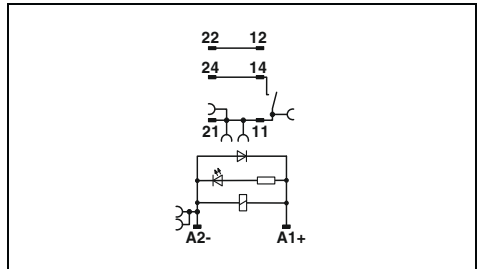

Technical data

Input data	①	See diagram
Permissible range (with reference to U_N)		18
Typical input current at U_N	[mA]	8
Typical response time at U_N	[ms]	10
Typical release time at U_N	[ms]	Yellow LED, damping diode
Input circuit DC		
Output data		
Contact type		1 N/O contact
Contact material		AgSnO
Max. switching voltage		250 V AC/DC
Minimum switching voltage		12 V AC/DC (at 100 mA)
Limiting continuous current		6 A
Maximum switch-on current DC		80 A (for 20 ms) / 130 A (peak, at capacitive load, 230 V AC, 24 μ F)
Minimum switching current		100 mA (at 12 V DC)
General data		
Test voltage (winding/contact)		4 kV AC (50 Hz, 1 min.)
Ambient temperature (operation), DC		-40°C ... 70°C
Nominal operating mode		100% operating factor
Mechanical service life, DC		3x 10 ⁷ cycles
Standards/regulations		EN 50178, EN 61810-1
Degree of pollution/surge voltage category		2 / III
Mounting position/mounting		Any / in rows with zero spacing
Connection data solid/stranded/AWG		0.14 ... 1.5 mm ² / 0.14 ... 1.5 mm ² / 26 - 16
Dimensions	W / H / D	16 mm / 93 mm / 75 mm

Ordering data

Description	Input voltage U_N	Type	Order No.	Pcs./Pkt.
Coupling relay modules for high inrush currents				
with Push-in connection	① 12 V DC	RIF-1-RPT-LDP-12DC/1IC	1078802	10
with Push-in connection	② 24 V DC	RIF-1-RPT-LDP-24DC/1IC	2909884	10
with screw connection	③ 12 V DC	RIF-1-RSC-LDP-12DC/1IC	1078803	10
with screw connection	④ 24 V DC	RIF-1-RSC-LDP-24DC/1IC	2909885	10

Operating voltage range

Curve A

Maximum permissible continuous voltage U_{max} with limiting continuous current on the contact side (see relevant technical data).

Curve B

Minimum permitted pick-up voltage U_{op} after pre-excitation (see relevant technical data).

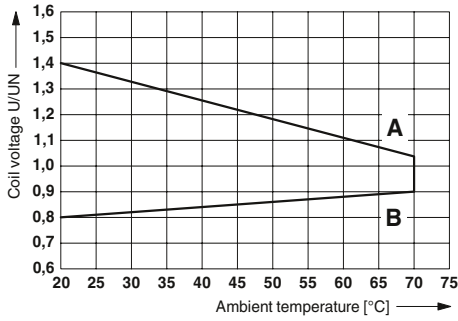

Interrupting rating

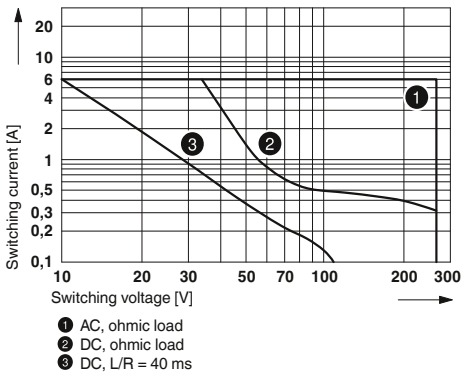

Basic behavior of capacitive loads:

- Very high input current
- Voltage increases with an e-function

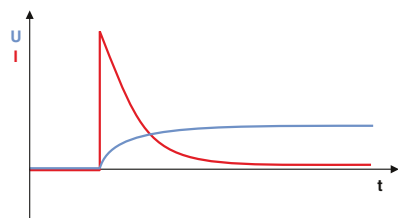

Fully mounted relay modules with tungsten lead contact relay

Fully mounted RIF-1 relay modules for very high inrush currents, e.g., from LEDs, consisting of:

- Relay base with Push-in connection
- 1-N/O-contact relay
- Relay retaining bracket

The advantages:

- Maximum inrush current up to 800 A peak
- Logical contact arrangement, thanks to 1/3-level relay base
- Operational reliability, thanks to sealed relay
- Safe isolation between coil and contact side
- Professional bridging of adjacent modules saves wiring time
- For FBS 2-6 plug-in bridges for the input side (A2), see page 358
- For FBS 2-8 plug-in bridges for the output side (11/21), see page 358



new

1-N/O-contact relay module with Push-in and screw connection

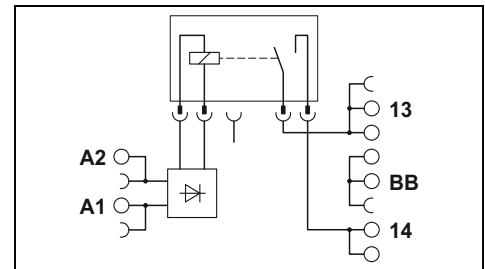

Technical data

Input data	①
Permissible range (with reference to U_N)	See diagram
Typical input current at U_N [mA]	18
Typical response time at U_N [ms]	8
Typical release time at U_N [ms]	10
Input circuit DC	Yellow LED, polarity protection diode, damping diode
Output data	
Contact type	1 N/O contact
Contact material	AgSnO
Max. switching voltage	250 V AC/DC
Minimum switching voltage	12 V (at 100 mA)
Limiting continuous current	6 A
Maximum switch-on current DC	165 A (20 ms) / 800 A (peak, at capacitive load, 230 V AC, 24 μ F)
Minimum switching current	100 mA (at 12 V DC)
General data	
Test voltage (winding/contact)	4 kV AC (50 Hz, 1 min.)
Ambient temperature (operation), DC	-40°C ... 70°C
Nominal operating mode	100% operating factor
Mechanical service life, DC	3x 10 ⁷ cycles
Standards/regulations	EN 50178, EN 61810-1
Degree of pollution/surge voltage category	2 / III
Mounting position/mounting	Any / in rows with zero spacing
Connection data solid/stranded/AWG	0.14 ... 1.5 mm ² / 0.14 ... 1.5 mm ² / 26 - 16
Dimensions	16 mm / 93 mm / 75 mm

Ordering data

Description	Input voltage U_N	Type	Order No.	Pcs./Pkt.
Coupling relay modules with tungsten lead contact relay				
with Push-in connection	① 24 V DC	RIF-1-RPT-LDP-24DC/1ICT	1078686	10
with screw connection	② 24 V DC	RIF-1-RSC-LDP-24DC/1ICT	1078681	10

Operating voltage range

Curve A

Maximum permissible continuous voltage U_{max} with limiting continuous current on the contact side (see relevant technical data).

Curve B

Minimum permitted pick-up voltage U_{op} after pre-excitation (see relevant technical data).

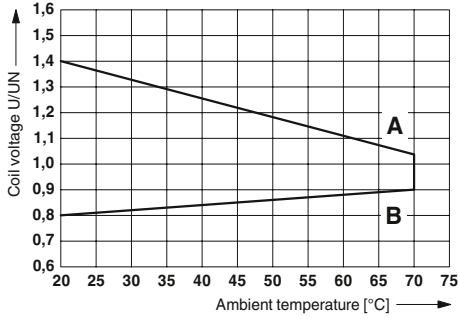

Interrupting rating

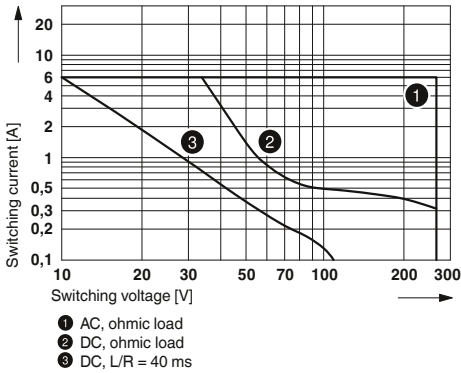

Basic behavior of capacitive loads:

- Very high input current
- Voltage increases with an e-function

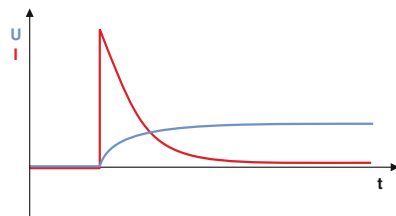

Relay modules

RIFLINE complete – Industrial relay system

Fully assembled RIF-1 coupling relay modules with force-guided contacts

Fully assembled RIF-1 coupling relay module with force-guided contacts, consisting of:

- Relay base with Push-in connection
- 2-changeover-contact relay with force-guided contacts in accordance with EN 50205
- Relay retaining bracket
- Interference suppression module

The advantages:

- Switching current of up to 2x 6 A
- Single-channel control
- Forcibly guided contacts in accordance with EN 50205
- Professional bridging of adjacent modules saves wiring time
- Integrated status LED and freewheeling diode
- The requirements for type A in accordance with DIN EN 50205 are satisfied if the circuit is designed as 1 N/O contact / 1 N/C contact

Notes:
Further voltage variants on request



2-changeover-contact relay module with force-guided contacts, max. 2 x 6 A

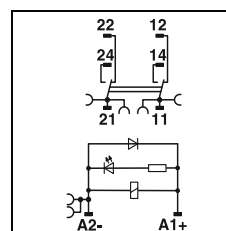

Input data	
Permissible range (with reference to U_N)	
Typical input current at U_N	[mA]
Typical response time at U_N	[ms]
Typical release time at U_N	[ms]
Input circuit DC	
Output data	
Contact type	
Contact material	
Max. switching voltage	
Minimum switching voltage	
Limiting continuous current	
Maximum switch-on current	
Minimum switching current	
General data	
Ambient temperature (operation)	
Nominal operating mode	
Mechanical service life	
Standards/regulations	
Degree of pollution/surge voltage category	
Mounting position/mounting	
Connection data solid/stranded/AWG	
Dimensions	W / H / D
Conformance/approvals	
Conformance	
ATEX	-
IECEX	-
UL, USA	-
UL, USA/Canada	cULus listed UL 508
UL, Canada	-
EMC note	Class A product, see page 583

Technical data		
①	See diagram	
	30	
	10	
	10	
	Yellow LED, damping diode	
	2 changeover contacts, forcibly actuated	
	AgNi	
	250 V AC/DC	
	15 V AC/DC	
	6 A	
	6 A	
	10 mA	
	-20°C ... 50°C	
	100% operating factor	
	Approx. 10 ⁷ cycles	
	DIN EN 50178/VDE 0160, EN 50205	
	2 / III	
	Any / in rows with zero spacing	
	0.14 ... 1.5 mm ² / 0.14 ... 1.5 mm ² / 26 - 16	
	16 mm / 93 mm / 70 mm	
	CE-compliant	
	-	
	-	
	-	
	cULus listed UL 508	
	-	
	Class A product, see page 583	

Description	Input voltage U_N
Coupling relay module with power contact relay and force-guided contacts	
with Push-in connection	① 24 V DC
with screw connection	① 24 V DC
Force-guided coupling relay with power contacts	
	① 24 V DC

Ordering data		
Type	Order No.	Pcs./Pkt.
RIF-1-RPT-LDP-24DC/2X21/FG	2908215	10
RIF-1-RSC-LDP-24DC/2X21/FG	2909848	10

RIF-1-RPT-LDP-24DC/2X21/FG



Relay with two changeover contacts with force-guided contacts, max. 2 x 6 A

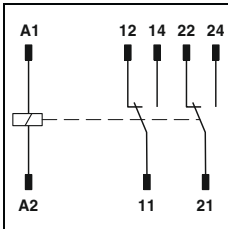

Operating voltage range

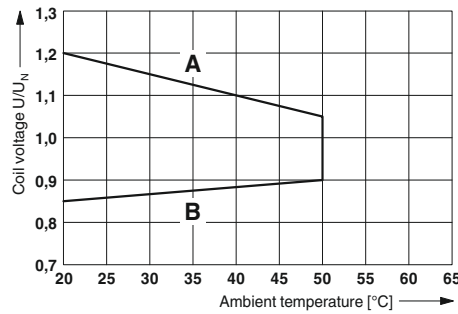

Contact derating

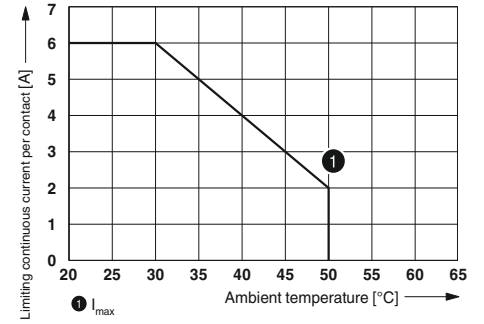

Technical data

①
See diagram
29
10
4

2 PDT
AgNi
250 V AC/DC
15 V
6 A
6 A
10 mA

-25°C ... 70°C
100% operating factor
Approx. 10⁷ cycles
DIN EN 50178, IEC 60664-1
2 / III
-
- ... - / - ... - / -
12.6 mm / 29 mm / 25.5 mm

REL-SR- 24DC/2X21/FG

Operating voltage range

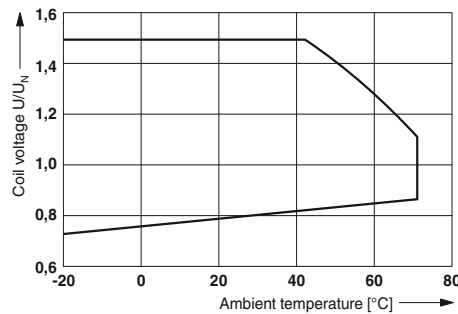

Interrupting rating

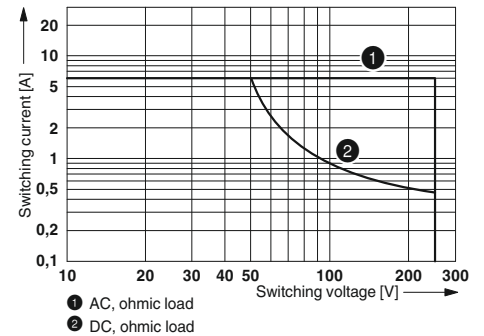

Ordering data

Type	Order No.	Pcs./Pkt.
REL-SR- 24DC/2X21/FG	2908777	20

Fully mounted RIF-2 relay modules

- Fully mounted RIF-2 relay modules, consisting of:
- Relay base with Push-in connection
 - 2- or 4-changeover-contact industrial relay
 - Relay retaining bracket
 - Varistor interference suppression module (AC types only)

- The advantages:
- Relay with lockable manual operation and status LED
 - With DC types, free-wheeling diode is integrated into relay
 - Mechanical switch position indicator
 - Logical contact arrangement, thanks to 1/3-level relay base
 - Professional bridging of adjacent modules saves wiring time
 - For FBS 2-6 plug-in bridges for the input side (A2), see page 358

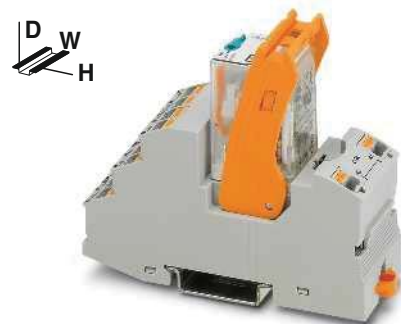

2-changeover-contact industrial relay module with Push-in connection and manual operation

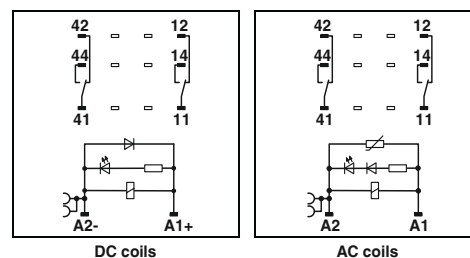

Input data	
Permissible range (with reference to U_N)	
Typical input current at U_N	[mA]
Typical response time at U_N	[ms]
Typical release time at U_N	[ms]
Input circuit AC	
Input circuit DC	
Output data	
Contact type	
Contact material	
Max. switching voltage	
Minimum switching voltage	
Limiting continuous current	
Maximum switch-on current AC	
Maximum switch-on current DC	
Minimum switching current	
General data	
Test voltage (winding/contact)	
Ambient temperature (operation), AC	
Ambient temperature (operation), DC	
Nominal operating mode	
Mechanical service life, AC	
Mechanical service life, DC	
Standards/regulations	
Degree of pollution/surge voltage category	
Mounting position/mounting	
Connection data solid/stranded/AWG	
Dimensions	W / H / D
EMC note	

Technical data			
①	②	③	④
See diagram			
42	66	13	6.5
13	5 - 15	5 - 15	5 - 15
14	5 - 20	5 - 20	5 - 20
Yellow LED, Varistor			
Yellow LED, damping diode			
2 PDT			
AgNi			
250 V AC/DC			
5 V (at 24 mA)			
10 A (see diagram)			
30 A (20 ms, N/O contact)			
30 A (20 ms, N/O contact)			
5 mA (at 24 V)			
2.5 kV _{rms} (50 Hz, 1 min.)			
-40°C ... 50°C			
-40°C ... 60°C			
100% operating factor			
Approx. 2x 10 ⁷ cycles			
Approx. 2x 10 ⁷ cycles			
DIN EN 50178			
2 / III			
Any / in rows with zero spacing			
0.14 ... 1.5 mm ² / 0.14 ... 1.5 mm ² / 26 - 16			
31 mm / 96 mm / 75 mm			
Class A product, see page 583			

Description	Input voltage U_N
Pre-assembled coupling relay modules with power contact relay and Push-in connection	① 24 V DC
	② 24 V AC
	③ 120 V AC
	④ 230 V AC

Ordering data		
Type	Order No.	Pcs./Pkt.
RIF-2-RPT-LDP-24DC/2X21	2903315	10
RIF-2-RPT-LV-24AC/2X21	2903313	10
RIF-2-RPT-LV-120AC/2X21	2903311	10
RIF-2-RPT-LV-230AC/2X21	2903310	10



4-changeover-contact industrial relay module with Push-in connection and manual operation

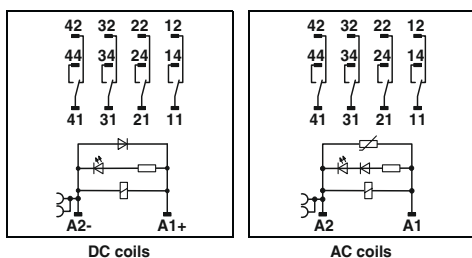

Technical data

①	②	③	④
See diagram			
42	66	13	6.5
13	5 - 15	5 - 15	5 - 15
14	5 - 20	5 - 20	5 - 20
Yellow LED, Varistor			
Yellow LED, damping diode			

- 4 PDTs
- AgNi
- 250 V AC/DC
- 5 V (at 24 mA)
- 6 A (see diagram)
- 16 A (20 ms, N/O contact)
- 16 A (20 ms, N/O contact)
- 5 mA (at 24 V)

- 2.5 kV_{rms} (50 Hz, 1 min.)
- 40°C ... 50°C
- 40°C ... 60°C
- 100% operating factor
- Approx. 2x 10⁷ cycles
- Approx. 2x 10⁷ cycles
- DIN EN 50178
- 2 / II

- Any / in rows with zero spacing
- 0.14 ... 1.5 mm² / 0.14 ... 1.5 mm² / 26 - 16
- 31 mm / 96 mm / 75 mm
- Class A product, see page 583

Ordering data

Type	Order No.	Pcs./Pkt.
RIF-2-RPT-LDP-24DC/4X21	2903308	10
RIF-2-RPT-LV-24AC/4X21	2903306	10
RIF-2-RPT-LV-120AC/4X21	2903305	10
RIF-2-RPT-LV-230AC/4X21	2903304	10

RIF-2-RPT.../2X21 (2 changeover contacts)

Operating voltage range

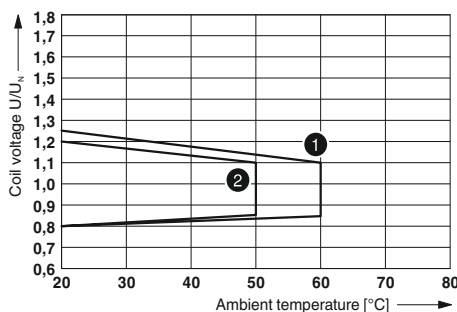

- ① DC coil (observe contact derating)
- ② AC coil (observe contact derating)

Interrupting rating

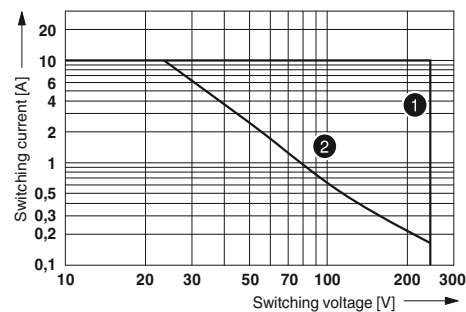

- ① AC, ohmic load
- ② DC, ohmic load

Contact derating

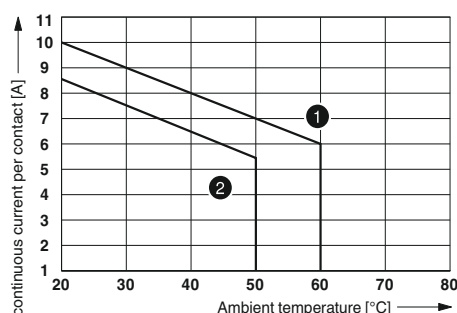

- ① DC coil
- ② AC coil

Electrical service life

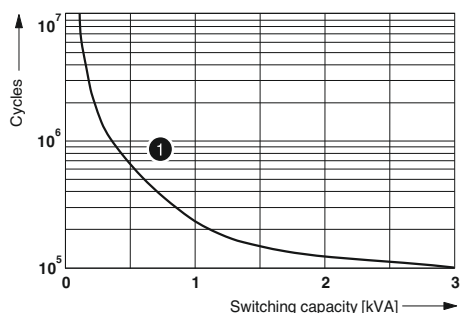

- ① 250 V AC, ohmic load

RIF-2-RPT.../4X21 (4 changeover contacts)

Operating voltage range

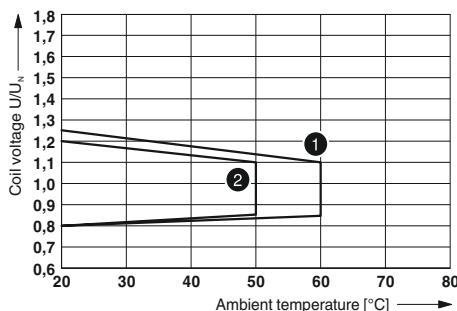

- ① DC coil (observe contact derating)
- ② AC coil (observe contact derating)

Interrupting rating

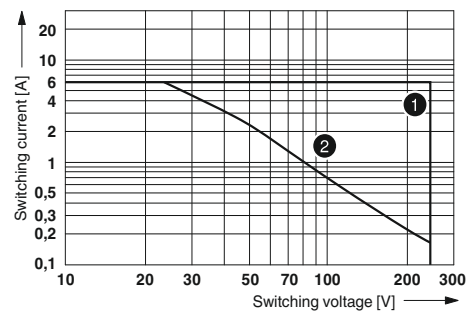

- ① AC, ohmic load
- ② DC, ohmic load

Contact derating

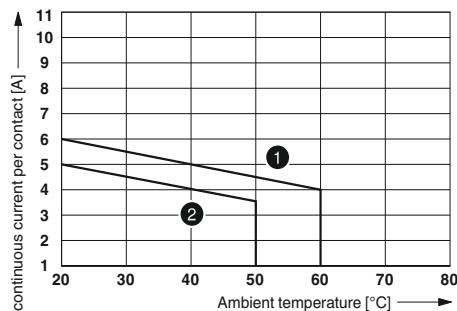

- ① DC coil
- ② AC coil

Electrical service life

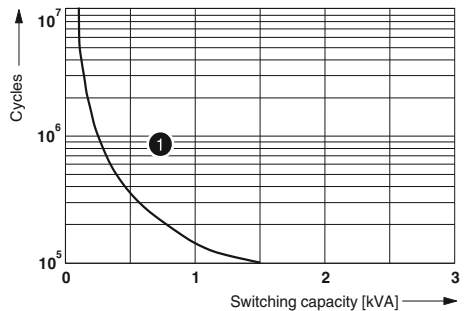

- ① 250 V AC, ohmic load

Fully mounted RIF-2 relay modules

Fully mounted RIF-2 relay modules, consisting of:

- Relay base with screw connection
- 2 or 4 changeover contacts relay
- Relay retaining bracket
- Interference suppression module (AC types only)

The advantages:

- Relay with lockable manual operation and status LED
- With DC types, free-wheeling diode is integrated into relay
- Mechanical switch position indicator
- Logical contact arrangement, thanks to 1/3-level relay base
- Professional bridging of adjacent modules saves wiring time
- For FBS 2-6 plug-in bridges for the input side (A2), see page 358

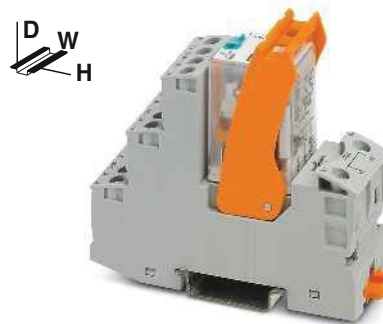

2-changeover-contact industrial relay module with screw connection and manual operation

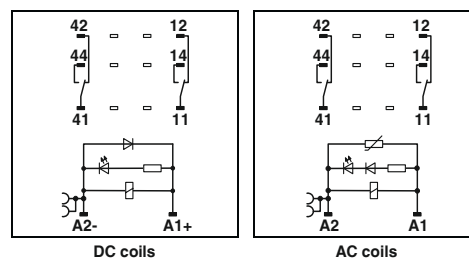

		Technical data				
		①	②	③	④	⑤
Input data		See diagram				
Permissible range (with reference to U_N)		42	7.5	66	13	6.5
Typical input current at U_N	[mA]	13	13	5 - 15	5 - 15	5 - 15
Typical response time at U_N	[ms]	14	14	5 - 20	5 - 20	5 - 20
Typical release time at U_N	[ms]	Yellow LED, Varistor				
Input circuit AC		Yellow LED, damping diode				
Input circuit DC						
Output data		2 PDT				
Contact type		AgNi				
Contact material		250 V AC/DC				
Max. switching voltage		5 V (at 24 mA)				
Minimum switching voltage		10 A (see diagram)				
Limiting continuous current		30 A (20 ms, N/O contact)				
Maximum switch-on current AC		30 A (20 ms, N/O contact)				
Maximum switch-on current DC		5 mA (at 24 V)				
Minimum switching current						
General data		2.5 kV _{rms} (50 Hz, 1 min.)				
Test voltage (winding/contact)		-40°C ... 50°C				
Ambient temperature (operation), AC		-40°C ... 60°C				
Ambient temperature (operation), DC		100% operating factor				
Nominal operating mode		Approx. 2x 10 ⁷ cycles				
Mechanical service life, AC		Approx. 2x 10 ⁷ cycles				
Mechanical service life, DC		DIN EN 50178				
Standards/regulations		2 / III				
Degree of pollution/surge voltage category						
Mounting position/mounting		Any / in rows with zero spacing				
Connection data solid/stranded/AWG		0.5 ... 4 mm ² / 0.5 ... 4 mm ² / 20 - 10				
Dimensions		27 mm / 89 mm / 75 mm				
EMC note		Class A product, see page 583				

		Ordering data		
Description	Input voltage U_N	Type	Order No.	Pcs./Pkt.
Pre-assembled coupling relay modules with power contact relay and screw connection				
	① 24 V DC	RIF-2-RSC-LDP-24DC/2X21	2903326	10
	② 125 V DC	RIF-2-RSC-LDP-125DC/2X21	2903324	10
	③ 24 V AC	RIF-2-RSC-LV-24AC/2X21	2903323	10
	④ 120 V AC	RIF-2-RSC-LV-120AC/2X21	2903322	10
	⑤ 230 V AC	RIF-2-RSC-LV-230AC/2X21	2903321	10



4-changeover-contact industrial relay module with screw connection and manual operation

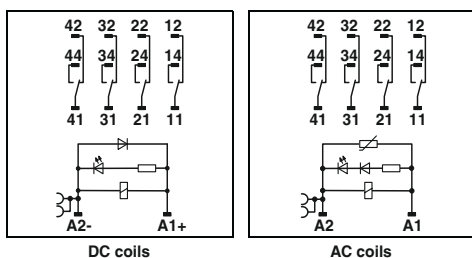

Technical data

①	②	③	④	⑤
See diagram				
42	7.5	66	13	6.5
13	13	5 - 15	5 - 15	5 - 15
14	14	5 - 20	5 - 20	5 - 20
Yellow LED, Varistor				
Yellow LED, damping diode				

- 4 PDTs
- AgNi
- 250 V AC/DC
- 5 V (at 24 mA)
- 6 A (see diagram)
- 16 A (20 ms, N/O contact)
- 16 A (20 ms, N/O contact)
- 5 mA (at 24 V)

- 2.5 kV_{rms} (50 Hz, 1 min.)
- 40°C ... 50°C
- 40°C ... 60°C
- 100% operating factor
- Approx. 2x 10⁷ cycles
- Approx. 2x 10⁷ cycles
- DIN EN 50178
- 2 / II

- Any / in rows with zero spacing
- 0.5 ... 4 mm² / 0.5 ... 4 mm² / 20 - 10
- 27 mm / 89 mm / 75 mm
- Class A product, see page 583

Ordering data

Type	Order No.	Pcs./Pkt.
RIF-2-RSC-LDP-24DC/4X21	2903320	10
RIF-2-RSC-LDP-125DC/4X21	2903319	10
RIF-2-RSC-LV-24AC/4X21	2903318	10
RIF-2-RSC-LV-120AC/4X21	2903317	10
RIF-2-RSC-LV-230AC/4X21	2903316	10

RIF-2-RSC.../2X21 (2 changeover contacts)

Operating voltage range

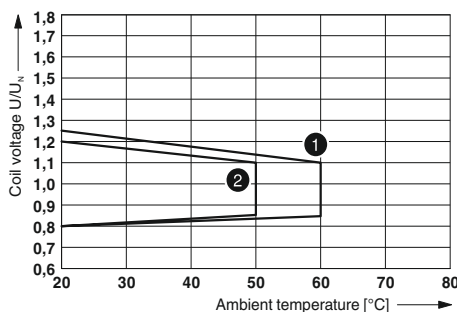

- ① DC coil (observe contact derating)
- ② AC coil (observe contact derating)

Interrupting rating

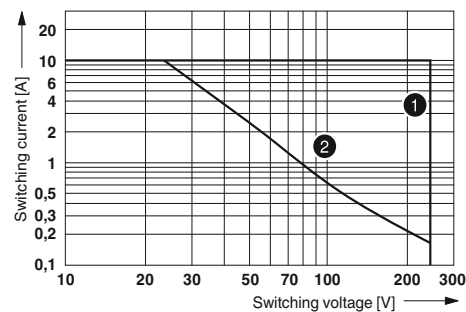

- ① AC, ohmic load
- ② DC, ohmic load

Contact derating

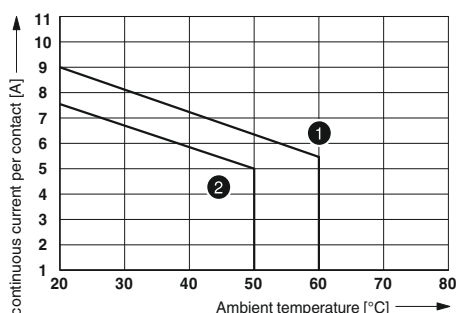

- ① DC coil
- ② AC coil

Electrical service life

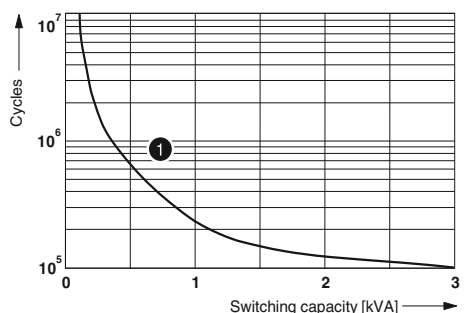

- ① 250 V AC, ohmic load

RIF-2-RSC.../4X21 (4 changeover contacts)

Operating voltage range

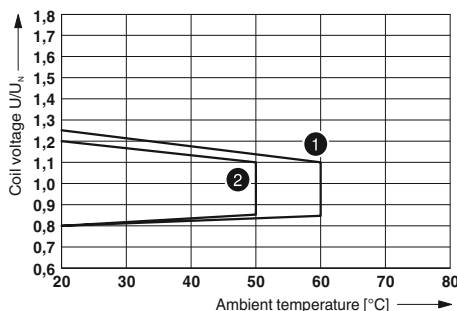

- ① DC coil (observe contact derating)
- ② AC coil (observe contact derating)

Interrupting rating

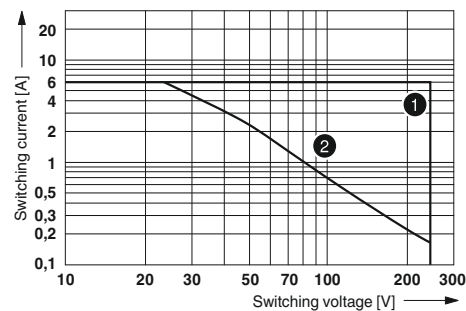

- ① AC, ohmic load
- ② DC, ohmic load

Contact derating

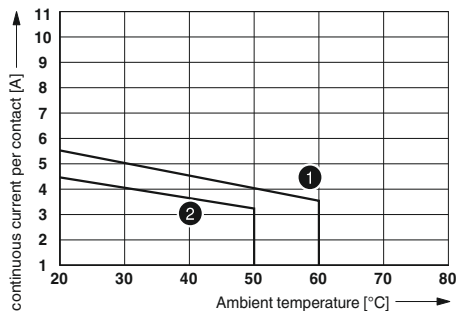

- ① DC coil
- ② AC coil

Electrical service life

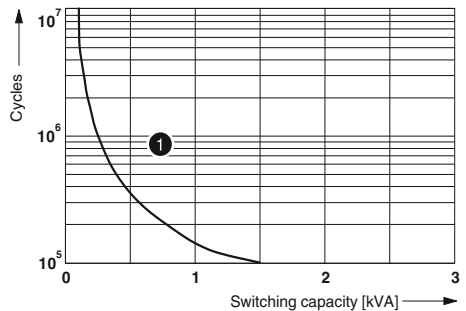

- ① 250 V AC, ohmic load

Fully mounted RIF-2 relay modules for the Ex area

Relay modules with ATEX, IECEx, and/or Class 1, Division 2 approval for potentially explosive applications

The advantages:

- ATEX, IECEx, and Class1 Division 2 approval in screw and Push-in connection technology
- Safe isolation in accordance with DIN EN 50178 between coil and contact

Fully mounted RIF-2 relay modules, consisting of:

- Relay base with screw or PT connection
- Relay retaining bracket
- Plug-in interference suppression modules
- Sealed 4-changeover-contact industrial relays
- Mechanical switch position indicator
- Logical contact arrangement, thanks to 1/3-level relay base
- Professional bridging of adjacent modules saves wiring time



4-changeover-contact industrial relay module with IECEx, ATEX, and Cl. 1 Div. 2 approval

Ex: Ex:

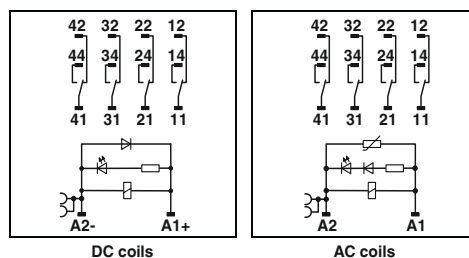

Input data	
Permissible range (with reference to U_N)	
Typical input current at U_N	[mA]
Typical response time at U_N	[ms]
Typical release time at U_N	[ms]
Input circuit AC	
Input circuit DC	
Output data	
Contact type	
Contact material	
Max. switching voltage	
Minimum switching voltage	
Limiting continuous current	
Maximum switch-on current AC	
Maximum switch-on current DC	
Minimum switching current	
General data	
Test voltage (winding/contact)	
Ambient temperature (operation), AC	
Ambient temperature (operation), DC	
Nominal operating mode	
Mechanical service life, AC	
Mechanical service life, DC	
Standards/regulations	
Degree of pollution/surge voltage category	
Mounting position/mounting	
Connection data solid/stranded/AWG	
Dimensions	W / H / D
Conformance/approvals	
ATEX	
IECEx	
UL, USA/Canada	
EMC note	

Technical data		
①	②	③
See diagram		
42	13	6.5
13	5 - 15	5 - 15
14	5 - 20	5 - 20
Yellow LED, Varistor		
Yellow LED, damping diode		
4 PDTs		
AgNi		
250 V AC/DC		
5 V (at 24 mA)		
6 A (see diagram)		
16 A (20 ms, N/O contact)		
16 A (20 ms, N/O contact)		
5 mA (at 24 V)		
2.5 kV _{rms} (50 Hz, 1 min.)		
-40°C ... 50°C		
-40°C ... 60°C		
100% operating factor		
Approx. 2x 10 ⁷ cycles		
Approx. 2x 10 ⁷ cycles		
DIN EN 50178, IEC 61508-1		
2 / III		
Any / in rows with zero spacing		
0.14 ... 1.5 mm ² / 0.14 ... 1.5 mm ² / 26 - 16		
31 mm / 96 mm / 75 mm		
II 3G Ex ec nC IIC T4 Gc (IBEU17ATEXB014X)		
Ex ec nC IIC T4 Gc (IECEx IBE 17.0032X)		
Class I, Div. 2, Groups A, B, C, D T4		
Class I, Zone 2, Group IIC		
Class A product, see page 583		

Description	Input voltage U_N
Pre-assembled coupling relay modules for the Ex area	
with Push-in connection	① 24 V DC
with Push-in connection	② 120 V AC
with Push-in connection	③ 230 V AC
with screw connection	④ 24 V DC
with screw connection	⑤ 120 V AC
with screw connection	⑥ 230 V AC
Single relay	
	① 24 V DC
	② 120 V AC
	③ 230 V AC

Ordering data		
Type	Order No.	Pcs./Pkt.
RIF-2-RPT-LDP-24DC/4X21/EX	2909741	10
RIF-2-RPT-LV-120AC/4X21/EX	2909740	10
RIF-2-RPT-LV-230AC/4X21/EX	2909739	10
RIF-2-RSC-LDP-24DC/4X21/EX	2909845	10
RIF-2-RSC-LV-120AC/4X21/EX	2909846	10
RIF-2-RSC-LV-230AC/4X21/EX	2909847	10

new



Sealed industrial relay with four changeover contacts, 4 x 6 A, maximum

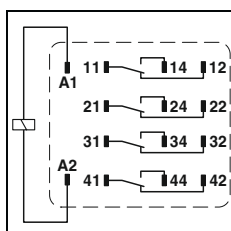

Technical data

①	②	③
See diagram		
38	13	6.5
13	5 - 15	5 - 15
3	5 - 20	5 - 20

4 PDTs
 AgNi
 250 V AC/DC
 5 V (at 24 mA)
 6 A
 16 A (20 ms, N/O contact)
 16 A (20 ms, N/O contact) / 12 A (4 s, 4 N/O contacts)

5 mA (at 24 V)

2.5 kV_{rms} (50 Hz, 1 min.)
 -40°C ... 55°C
 -40°C ... 70°C
 100% operating factor
 Approx. 2x 10⁷ cycles
 1x 10⁷ cycles, approximately
 IEC 60664, IEC 61810
 2 / II
 any
 - ... - / - ... - / -
 21.2 mm / 27.5 mm / 35.6 mm

Ordering data

Type	Order No.	Pcs./Pkt.
REL-IR4/24DC/4X21/EX	2909738	10
REL-IR4/120AC/4X21/EX	2909744	10
REL-IR4/230AC/4X21/EX	2909742	10

RIF-2-R.../4X21/EX

Operating voltage range

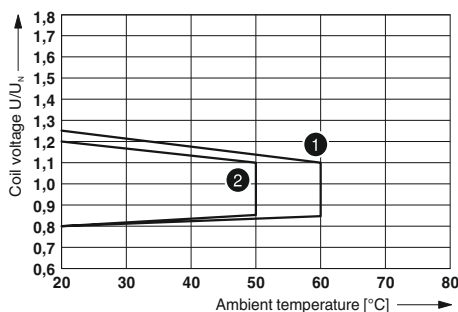

- ① DC coil (observe contact derating)
- ② AC coil (observe contact derating)

Contact derating

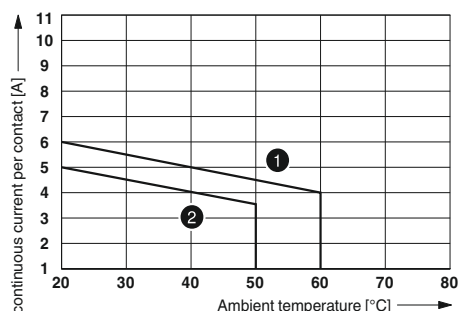

- ① DC coil
- ② AC coil

Interrupting rating

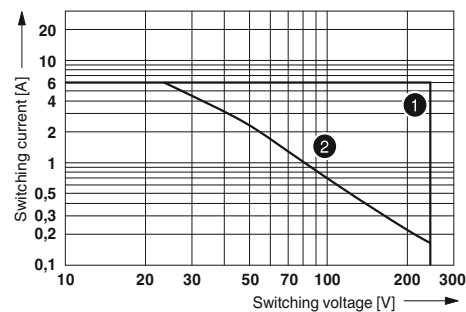

- ① AC, ohmic load
- ② DC, ohmic load

Electrical service life

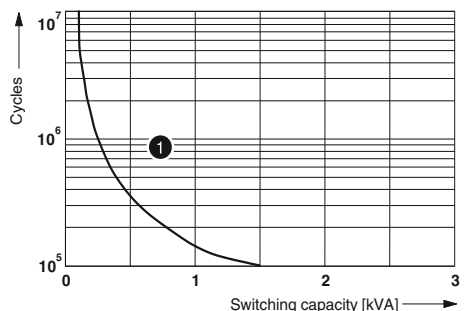

- ① 250 V AC, ohmic load

REL-IR4.../4X21/EX

Operating voltage range

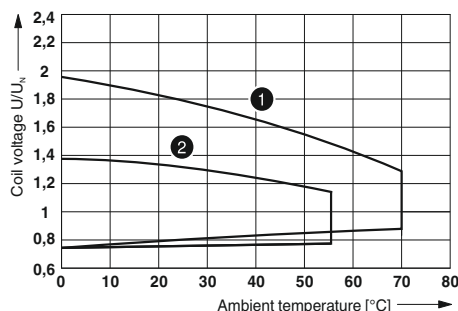

- ① DC coils
- ② AC coils

Interrupting rating

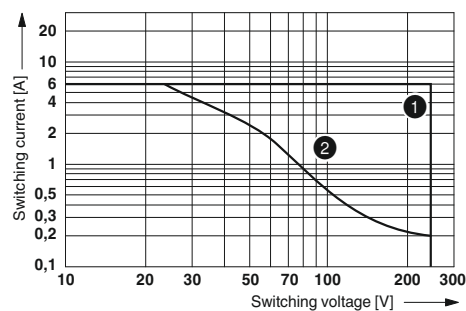

- ① AC, ohmic load
- ② DC, ohmic load

Electrical service life

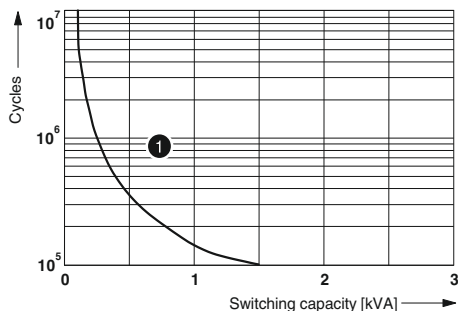

- ① 250 V AC, ohmic load

Service life reduction factor

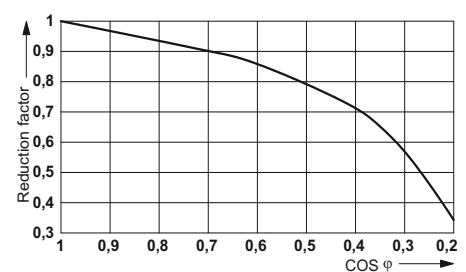

Fully mounted RIF-3 relay modules

Fully mounted RIF-3 relay modules, consisting of:

- Relay base with Push-in connection
- 2 or 3-changeover-contact octal relay
- Relay retaining bracket
- Interference suppression module (AC types only)

The advantages:

- Relay with lockable manual operation and status LED
- With DC types, free-wheeling diode is integrated into relay
- Mechanical switch position indicator
- Logical contact arrangement, thanks to 1/3-level relay base
- Professional bridging of adjacent modules saves wiring time
- For FBS 2-6 plug-in bridges for the input side (A2), see page 358



2-changeover-contact octal relay module with Push-in connection and manual operation

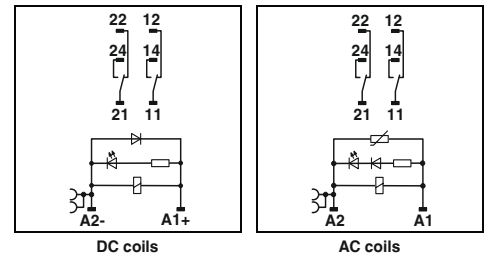

Input data		①	②	③
Permissible range (with reference to U_N)		See diagram		
Typical input current at U_N	[mA]	60	23	13
Typical response time at U_N	[ms]	18	5 - 15	5 - 15
Typical release time at U_N	[ms]	20	5 - 20	5 - 20
Input circuit AC		Yellow LED, Varistor		
Input circuit DC		Yellow LED, damping diode		
Output data				
Contact type		2 PDT		
Contact material		AgNi		
Max. switching voltage		250 V AC/DC		
Minimum switching voltage		10 V (at 24 mA)		
Limiting continuous current		10 A (see diagram)		
Maximum switch-on current AC		30 A (20 ms, N/O contact)		
Maximum switch-on current DC		30 A (20 ms, N/O contact)		
Minimum switching current		10 mA (at 24 V)		
General data				
Test voltage (winding/contact)		2.5 kV _{rms} (50 Hz, 1 min.)		
Ambient temperature (operation), AC		-40°C ... 50°C		
Ambient temperature (operation), DC		-40°C ... 60°C		
Nominal operating mode		100% operating factor		
Mechanical service life, AC		Approx. 2x 10 ⁷ cycles		
Mechanical service life, DC		Approx. 2x 10 ⁷ cycles		
Standards/regulations		DIN EN 50178		
Degree of pollution/surge voltage category		2 / III		
Mounting position/mounting		Any / in rows with zero spacing		
Connection data solid/stranded/AWG		0.14 ... 1.5 mm ² / 0.14 ... 1.5 mm ² / 26 - 16		
Dimensions	W / H / D	40 mm / 103 mm / 90 mm		
EMC note		Class A product, see page 583		

Description	Input voltage U_N
Pre-assembled coupling relay modules with power contact relay and Push-in connection	① 24 V DC
	② 120 V AC
	③ 230 V AC

Ordering data		
Type	Order No.	Pcs./Pkt.
RIF-3-RPT-LDP-24DC/2X21	2903297	5
RIF-3-RPT-LV-120AC/2X21	2903296	5
RIF-3-RPT-LV-230AC/2X21	2903295	5

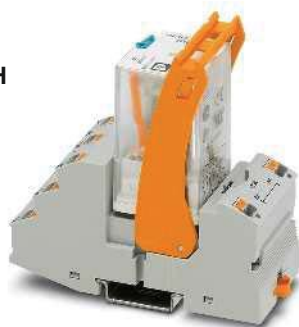

3-changeover-contact octal relay module with Push-in connection and manual operation

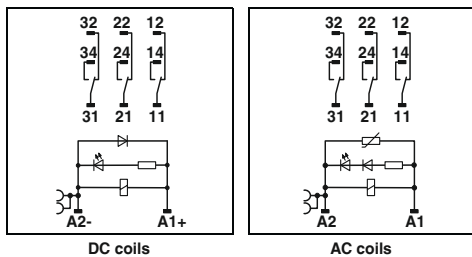

Technical data

①	②	③
See diagram		
60	23	13
18	5 - 15	5 - 15
20	5 - 20	5 - 20
Yellow LED, Varistor		
Yellow LED, damping diode		

3 PDTs
 AgNi
 250 V AC/DC
 10 V (at 24 mA)
 8.5 A (see diagram)
 30 A (20 ms, N/O contact)
 30 A (20 ms, N/O contact)
 10 mA (at 24 V)

2.5 kV_{rms} (50 Hz, 1 min.)
 -40°C ... 50°C
 -40°C ... 60°C
 100% operating factor
 Approx. 2x 10⁷ cycles
 Approx. 2x 10⁷ cycles
 DIN EN 50178
 2 / III

Any / in rows with zero spacing
 0.14 ... 1.5 mm² / 0.14 ... 1.5 mm² / 26 - 16
 40 mm / 103 mm / 90 mm
 Class A product, see page 583

Ordering data

Type	Order No.	Pcs./Pkt.
RIF-3-RPT-LDP-24DC/3X21	2903294	5
RIF-3-RPT-LV-120AC/3X21	2903293	5
RIF-3-RPT-LV-230AC/3X21	2903292	5

RIF-3-RPT.../2X21 (2 changeover contacts)

Operating voltage range

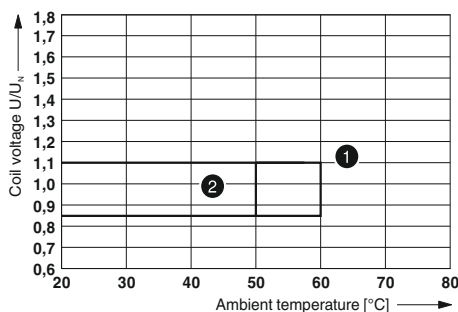

- ① DC coil (observe contact derating)
- ② AC coil (observe contact derating)

Interrupting rating

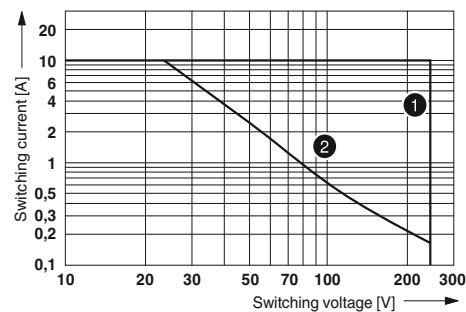

- ① AC, ohmic load
- ② DC, ohmic load

Contact derating

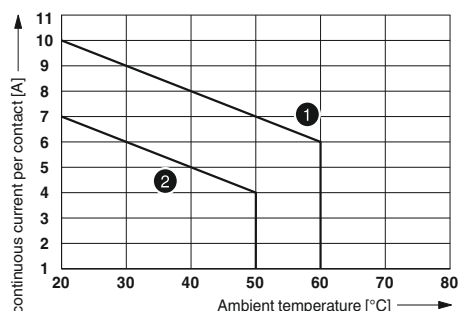

- ① DC coil
- ② AC coil

Electrical service life

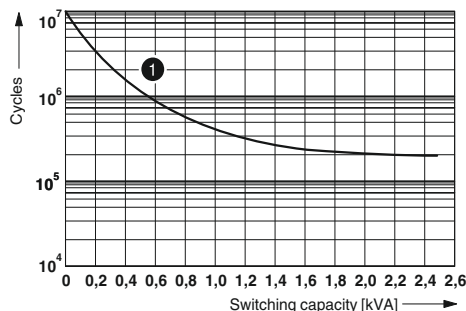

- ① 250 V AC, ohmic load

RIF-3-RPT.../3X21 (3 changeover contacts)

Operating voltage range

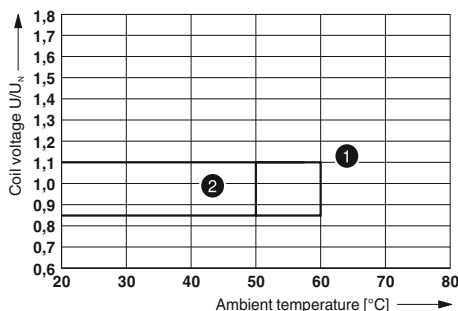

- ① DC coil (observe contact derating)
- ② AC coil (observe contact derating)

Interrupting rating

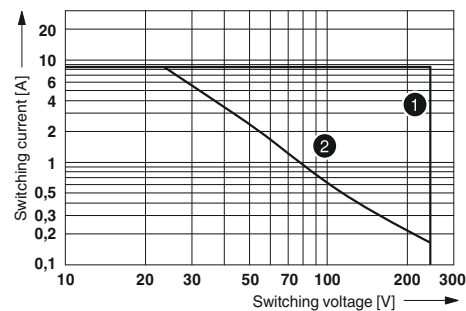

- ① AC, ohmic load
- ② DC, ohmic load

Contact derating

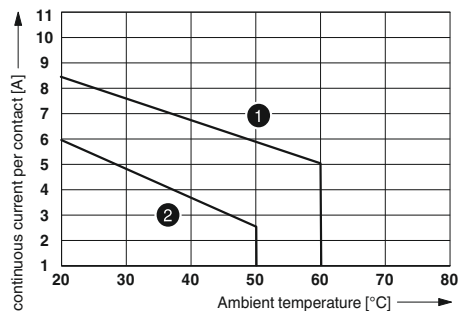

- ① DC coil
- ② AC coil

Electrical service life

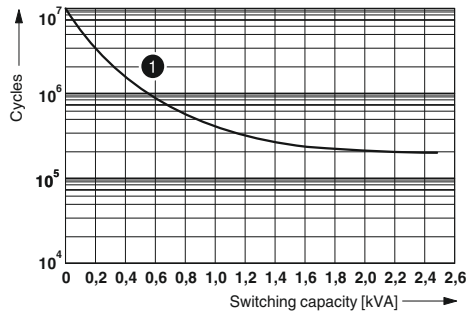

- ① 250 V AC, ohmic load

Fully mounted RIF-3 relay modules

Fully mounted RIF-3 relay modules, consisting of:

- Relay base with screw connection
- 2 or 3-changeover-contact octal relay
- Relay retaining bracket
- Varistor interference suppression module (AC types only)

The advantages:

- Relay with lockable manual operation and status LED
- With DC types, free-wheeling diode is integrated into relay
- Mechanical switch position indicator
- Logical contact arrangement, thanks to 1/3-level relay base
- Professional bridging of adjacent modules saves wiring time
- For FBS 2-6 plug-in bridges for the input side (A2), see page 358

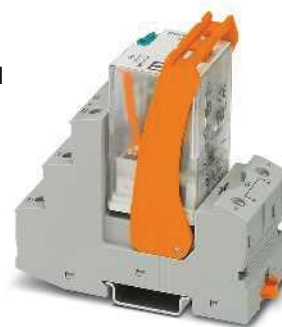

2-changeover-contact octal relay module with screw connection and manual operation

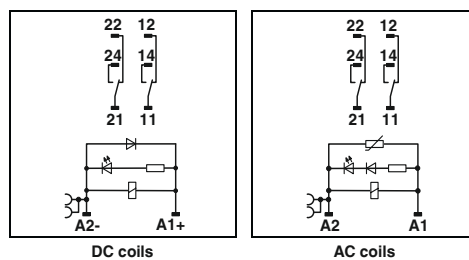

Input data		Technical data		
		①	②	③
Permissible range (with reference to U_N)		See diagram		
Typical input current at U_N	[mA]	60	23	13
Typical response time at U_N	[ms]	18	5 - 15	5 - 15
Typical release time at U_N	[ms]	20	5 - 20	5 - 20
Input circuit AC		Yellow LED, Varistor		
Input circuit DC		Yellow LED, damping diode		
Output data				
Contact type		2 PDT		
Contact material		AgNi		
Max. switching voltage		250 V AC/DC		
Minimum switching voltage		10 V (at 24 mA)		
Limiting continuous current		10 A (see diagram)		
Maximum switch-on current AC		30 A (20 ms, N/O contact)		
Maximum switch-on current DC		30 A (20 ms, N/O contact)		
Minimum switching current		10 mA (at 24 V)		
General data				
Test voltage (winding/contact)		2.5 kV _{rms} (50 Hz, 1 min.)		
Ambient temperature (operation), AC		-40°C ... 50°C		
Ambient temperature (operation), DC		-40°C ... 60°C		
Nominal operating mode		100% operating factor		
Mechanical service life, AC		Approx. 2x 10 ⁷ cycles		
Mechanical service life, DC		Approx. 2x 10 ⁷ cycles		
Standards/regulations		DIN EN 50178		
Degree of pollution/surge voltage category		2 / III		
Mounting position/mounting		Any / in rows with zero spacing		
Connection data solid/stranded/AWG		0.5 ... 4 mm ² / 0.5 ... 4 mm ² / 20 - 10		
Dimensions	W / H / D	40 mm / 96 mm / 90 mm		
EMC note		Class A product, see page 583		

Description	Input voltage U_N
Pre-assembled coupling relay modules with power contact relay and screw connection	① 24 V DC
	② 120 V AC
	③ 230 V AC

Ordering data		
Type	Order No.	Pcs./Pkt.
RIF-3-RSC-LDP-24DC/2X21	2903303	5
RIF-3-RSC-LV-120AC/2X21	2903302	5
RIF-3-RSC-LV-230AC/2X21	2903301	5

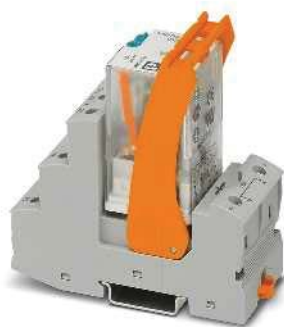

3-changeover-contact octal relay module with screw connection and manual operation

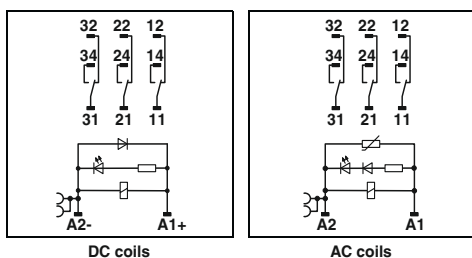

Technical data

①	②	③
See diagram		
60	23	13
18	5 - 15	5 - 15
20	5 - 20	5 - 20
Yellow LED, Varistor		
Yellow LED, damping diode		

- 3 PDTs
- AgNi
- 250 V AC/DC
- 10 V (at 24 mA)
- 8.5 A (see diagram)
- 30 A (20 ms, N/O contact)
- 30 A (20 ms, N/O contact)
- 10 mA (at 24 V)
- 2.5 kV_{rms} (50 Hz, 1 min.)
- 40°C ... 50°C
- 40°C ... 60°C
- 100% operating factor
- Approx. 2x 10⁷ cycles
- Approx. 2x 10⁷ cycles
- DIN EN 50178
- 2 / III

Any / in rows with zero spacing
 0.5 ... 4 mm² / 0.5 ... 4 mm² / 20 - 10
 40 mm / 96 mm / 90 mm
 Class A product, see page 583

Ordering data

Type	Order No.	Pcs./Pkt.
RIF-3-RSC-LDP-24DC/3X21	2903300	5
RIF-3-RSC-LV-120AC/3X21	2903299	5
RIF-3-RSC-LV-230AC/3X21	2903298	5

RIF-3-RSC.../2X21 (2 changeover contacts)

Operating voltage range

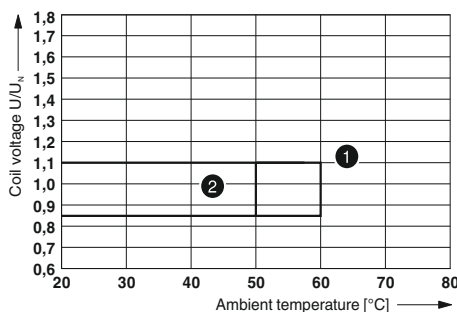

Interrupting rating

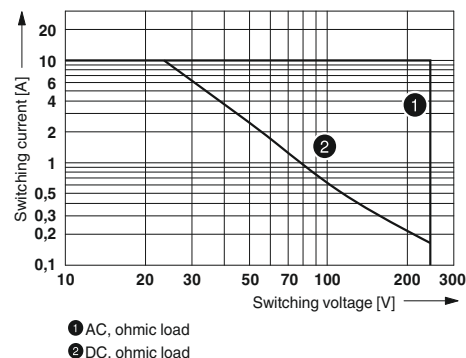

Contact derating

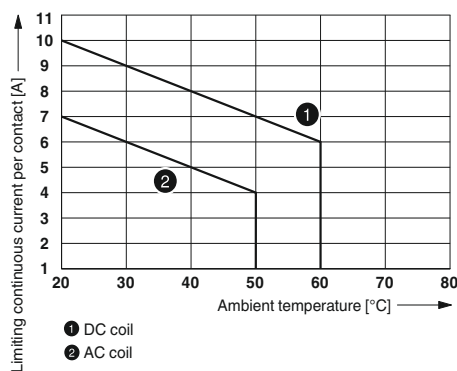

Electrical service life

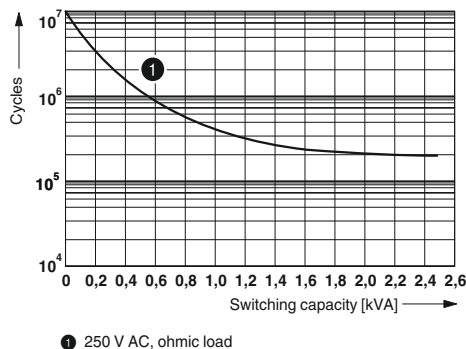

RIF-3-RSC.../3X21 (3 changeover contacts)

Operating voltage range

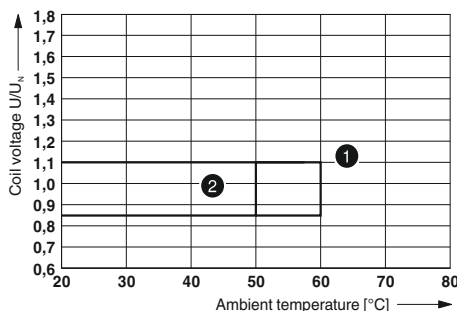

Interrupting rating

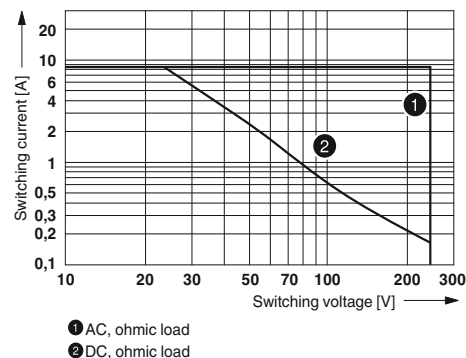

Contact derating

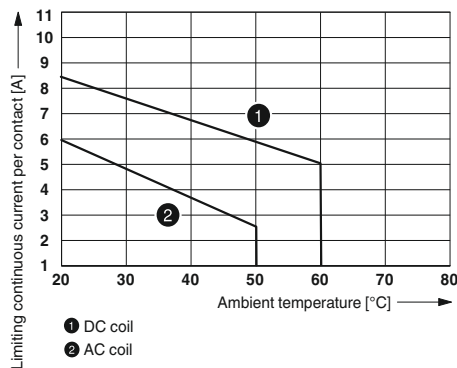

Electrical service life

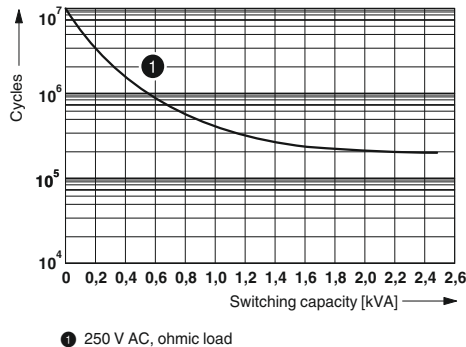

Fully mounted RIF-4 relay modules

Fully mounted RIF-4 relay modules, consisting of:

- Relay base with Push-in connection
- 2 or 3-PDT high-power relay
- Relay retaining bracket
- Varistor interference suppression module (AC types only)

The advantages:

- Logical contact arrangement, thanks to 1/3-level relay base
- Professional bridging of adjacent modules saves wiring time
- For FBS 2-6 plug-in bridges for the input side (A2), see page 358

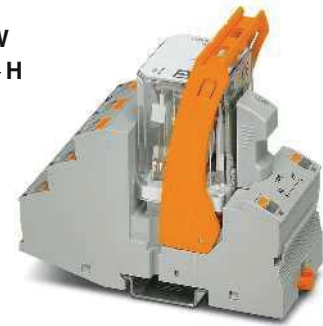

2-changeover-contact high-power relay module with Push-in connection

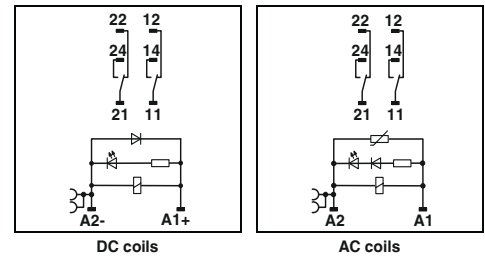

Input data	
Permissible range (with reference to U_N)	
Typical input current at U_N	[mA]
Typical response time at U_N	[ms]
Typical release time at U_N	[ms]
Input circuit AC	
Input circuit DC	
Output data	
Contact type	
Contact material	
Max. switching voltage	
Minimum switching voltage	
Limiting continuous current	
Maximum switch-on current AC	
Maximum switch-on current DC	
Minimum switching current	
Maximum interrupting rating, ohmic load	
	250 V AC
	440 V AC
Motor load in accordance with UL 508	
General data	
Test voltage (winding/contact)	
Ambient temperature (operation), AC	
Ambient temperature (operation), DC	
Nominal operating mode	
Mechanical service life, AC	
Mechanical service life, DC	
Standards/regulations	
Degree of pollution/surge voltage category	
Mounting position/mounting	
Connection data solid/stranded/AWG	
Input side	
Output side	
Dimensions	W / H / D
EMC note	

Technical data

①	②	③
See diagram		
56	24	14
20	5 - 25	5 - 25
20	5 - 20	5 - 20
Yellow LED, Varistor		
Yellow LED, damping diode		
2 PDT		
AgNi		
440 V AC / 250 V DC		
10 V (at 24 mA)		
11 A (see diagram)		
50 A (20 ms, N/O contact)		
50 A (20 ms, N/O contact)		
10 mA (at 24 V)		
2500 VA		
4,000 VA		
1/3 HP, 120 V AC (single-phase AC motor)		
1/2 HP, 240 V AC (single-phase AC motor)		

Ordering data

Description	Input voltage U_N	Type	Order No.	Pcs./Pkt.
Pre-assembled coupling relay modules with power contact relay and Push-in connection	① 24 V DC	RIF-4-RPT-LDP-24DC/2X21	2903281	5
	② 120 V AC	RIF-4-RPT-LV-120AC/2X21	2903280	5
	③ 230 V AC	RIF-4-RPT-LV-230AC/2X21	2903279	5



3-changeover-contact high-power relay module with Push-in connection

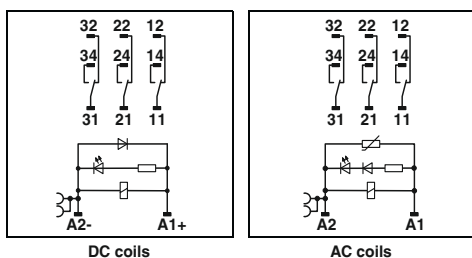

Technical data

①	②	③
See diagram		
56	24	14
20	5 - 25	5 - 25
20	5 - 20	5 - 20
Yellow LED, Varistor		
Yellow LED, damping diode		

3 PDTs
AgNi
440 V AC / 250 V DC
10 V (at 24 mA)
10 A (see diagram)
50 A (20 ms, N/O contact)
50 A (20 ms, N/O contact)
10 mA (at 24 V)

2500 VA
4,000 VA
1/3 HP, 120 V AC (single-phase AC motor)
1/2 HP, 240 V AC (single-phase AC motor)
1/2 HP, 240 V AC (three-phase induction motor)

2.5 kV_{rms} (50 Hz, 1 min.)
-40°C ... 40°C
-40°C ... 60°C
100% operating factor
Approx. 10⁷ cycles
Approx. 10⁷ cycles
DIN EN 50178
2 / III

Any / in rows with zero spacing

0.14 ... 1.5 mm² / 0.14 ... 1.5 mm² / 26 - 16
0.14 ... 2.5 mm² / 0.14 ... 2.5 mm² / 26 - 14
43 mm / 111 mm / 90 mm
Class A product, see page 583

Ordering data

Type	Order No.	Pcs./Pkt.
RIF-4-RPT-LDP-24DC/3X21	2903278	5
RIF-4-RPT-LV-120AC/3X21	2903277	5
RIF-4-RPT-LV-230AC/3X21	2903276	5

RIF-4-RPT.../2X21 (2 changeover contacts)

Operating voltage range

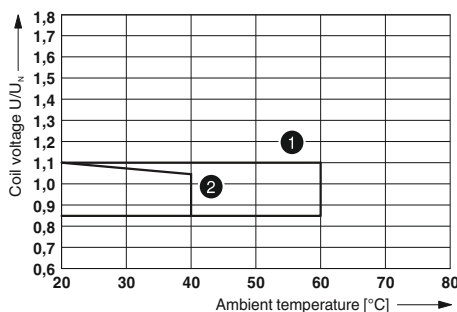

- ① DC coil (observe contact derating)
- ② AC coil (observe contact derating)

Interrupting rating

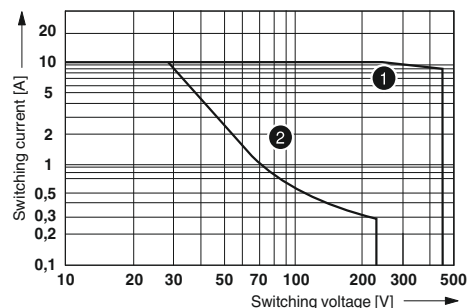

- ① AC, ohmic load
- ② DC, ohmic load

Contact derating

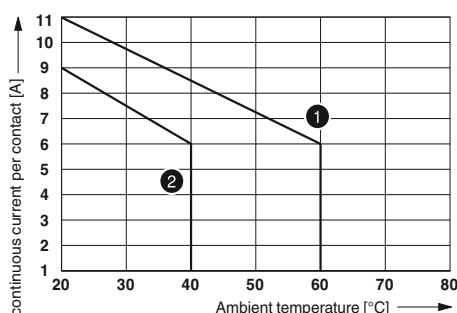

- ① DC coil
- ② AC coil

Electrical service life

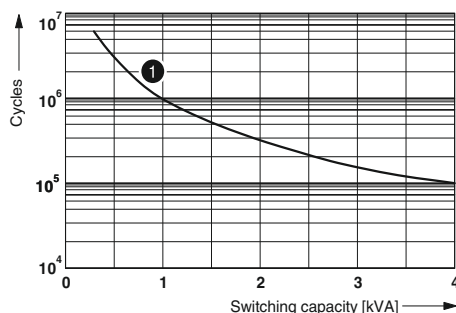

- ① 250 V AC, ohmic load

RIF-4-RPT.../3X21 (3 changeover contacts)

Operating voltage range

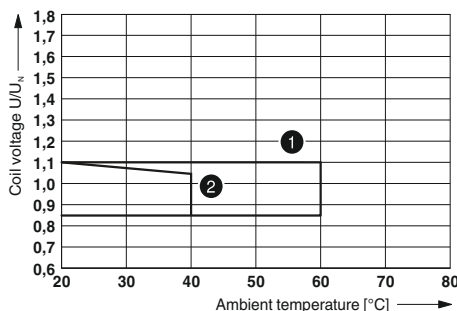

- ① DC coil (observe contact derating)
- ② AC coil (observe contact derating)

Interrupting rating

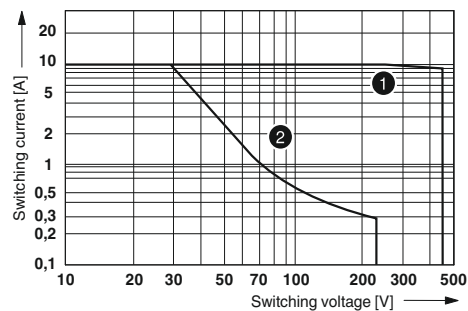

- ① AC, ohmic load
- ② DC, ohmic load

Contact derating

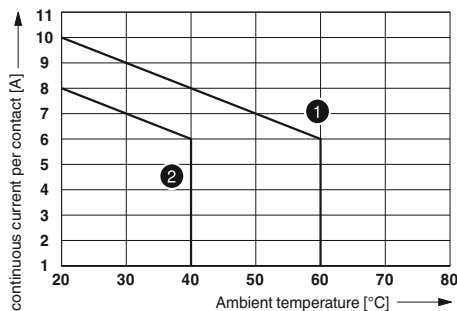

- ① DC coil
- ② AC coil

Electrical service life

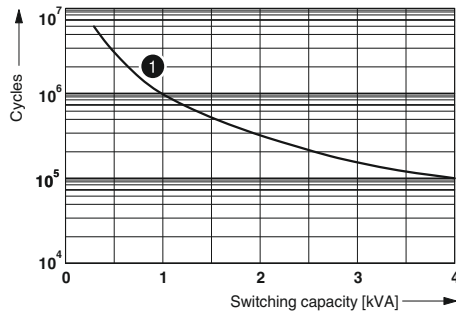

- ① 250 V AC, ohmic load

Fully mounted RIF-4 relay modules

Fully mounted RIF-4 relay modules, consisting of:

- Relay base with Push-in connection
- 3-N/O high-power relay
- Relay retaining bracket
- Varistor interference suppression module (AC types only)

The advantages:

- Logical contact arrangement, thanks to 1/3-level relay base
- Full shutdown by means of ≥ 3 mm contact opening
- Professional bridging of adjacent modules saves wiring time
- For FBS 2-6 plug-in bridges for the input side (A2), see page 358



3-N/O-contact high-power relay module with Push-in connection

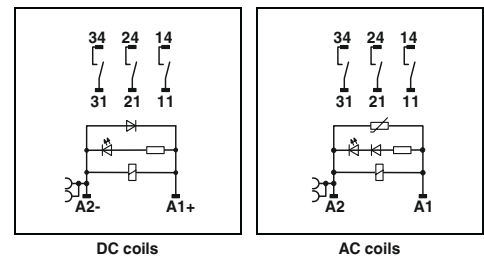

DC coils

AC coils

Technical data

		①	②	③
Input data		See diagram		
Permissible range (with reference to U_N)		70	24	14
Typical input current at U_N	[mA]	20	5 - 25	5 - 25
Typical response time at U_N	[ms]	20	5 - 20	5 - 20
Typical release time at U_N	[ms]	Yellow LED, Varistor		
Input circuit AC		Yellow LED, damping diode		
Input circuit DC				
Output data		3 N/O contacts		
Contact type		AgNi		
Contact material		440 V AC / 250 V DC		
Max. switching voltage		10 V (at 24 mA)		
Minimum switching voltage		10 A (see diagram)		
Limiting continuous current		50 A (20 ms, N/O contact)		
Maximum switch-on current AC		50 A (20 ms, N/O contact)		
Maximum switch-on current DC		10 mA (at 24 V)		
Minimum switching current				
Maximum interrupting rating, ohmic load	250 V AC	2500 VA		
	440 V AC	4,000 VA		
Motor load in accordance with UL 508		1/3 HP, 120 V AC (single-phase AC motor)		
		1/2 HP, 240 V AC (single-phase AC motor)		
		1/2 HP, 240 V AC (three-phase induction motor)		
General data		2.5 kV _{rms} (50 Hz, 1 min.)		
Test voltage (winding/contact)		-40°C ... 40°C		
Ambient temperature (operation), AC		-40°C ... 60°C		
Ambient temperature (operation), DC		100% operating factor		
Nominal operating mode		Approx. 10 ⁷ cycles		
Mechanical service life, AC		Approx. 10 ⁷ cycles		
Mechanical service life, DC		DIN EN 50178		
Standards/regulations		2 / III		
Degree of pollution/surge voltage category				
Mounting position/mounting		Any / in rows with zero spacing		
Connection data solid/stranded/AWG				
Input side		0.14 ... 1.5 mm ² / 0.14 ... 1.5 mm ² / 26 - 16		
Output side		0.14 ... 2.5 mm ² / 0.14 ... 2.5 mm ² / 26 - 14		
Dimensions	W / H / D	43 mm / 111 mm / 90 mm		
EMC note		Class A product, see page 583		

Ordering data

Description	Input voltage U_N	Type	Order No.	Pcs./Pkt.
Pre-assembled coupling relay modules with power contact relay and Push-in connection	① 24 V DC	RIF-4-RPT-LDP-24DC/3X1	2903275	5
	② 120 V AC	RIF-4-RPT-LV-120AC/3X1	2903274	5
	③ 230 V AC	RIF-4-RPT-LV-230AC/3X1	2903273	5

RIF-4-RPT.../3X1 (3 N/O contacts)

Operating voltage range

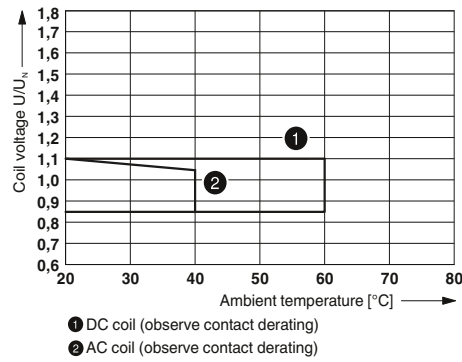

Interrupting rating

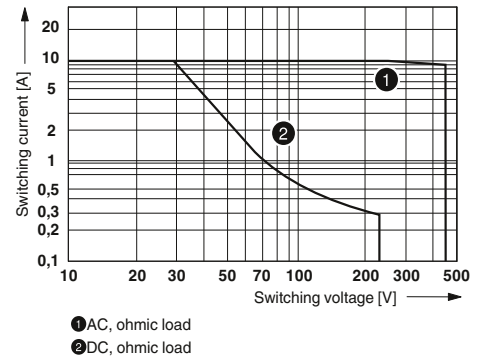

Contact derating

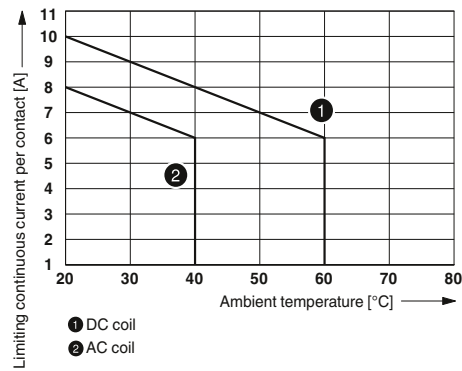

Electrical service life

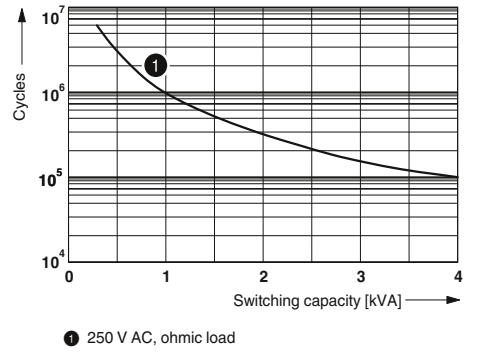

Fully mounted RIF-4 relay modules

Fully mounted RIF-4 relay modules, consisting of:

- Relay base with screw connection
- 3-PDT high-power relay
- Relay retaining bracket
- Varistor interference suppression module (AC types only)

The advantages:

- Logical contact arrangement, thanks to 1/3-level relay base
- Professional bridging of adjacent modules saves wiring time
- For FBS 2-6 plug-in bridges for the input side (A2), see page 358

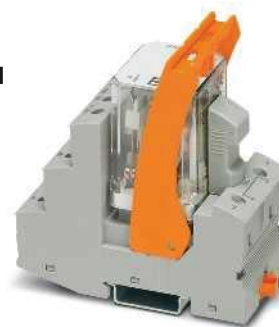

2 changeover-contact high-power relay module with screw connection

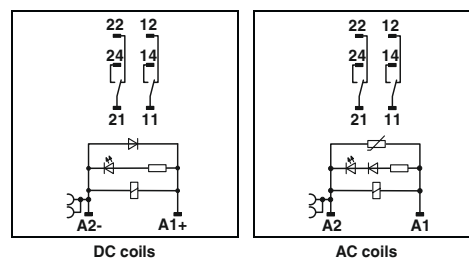

Technical data

		①	②	③
Input data		See diagram		
Permissible range (with reference to U_N)		56	24	14
Typical input current at U_N	[mA]	20	5 - 25	5 - 25
Typical response time at U_N	[ms]	20	5 - 20	5 - 20
Typical release time at U_N	[ms]	Yellow LED, Varistor		
Input circuit AC		Yellow LED, damping diode		
Input circuit DC				
Output data		2 PDT		
Contact type		AgNi		
Contact material		440 V AC / 250 V DC		
Max. switching voltage		10 V (at 24 mA)		
Minimum switching voltage		11 A (see diagram)		
Limiting continuous current		50 A (20 ms, N/O contact)		
Maximum switch-on current AC		50 A (20 ms, N/O contact)		
Maximum switch-on current DC		10 mA (at 24 V)		
Minimum switching current				
Maximum interrupting rating, ohmic load		250 V AC	2500 VA	
		440 V AC	4,000 VA	
Motor load in accordance with UL 508		1/3 HP, 120 V AC (single-phase AC motor)		
		1/2 HP, 240 V AC (single-phase AC motor)		
General data		2.5 kV _{rms} (50 Hz, 1 min.)		
Test voltage (winding/contact)		-40°C ... 40°C		
Ambient temperature (operation), AC		-40°C ... 60°C		
Ambient temperature (operation), DC		100% operating factor		
Nominal operating mode		Approx. 10 ⁷ cycles		
Mechanical service life, AC		Approx. 10 ⁷ cycles		
Mechanical service life, DC		DIN EN 50178		
Standards/regulations		2 / III		
Degree of pollution/surge voltage category				
Mounting position/mounting		Any / in rows with zero spacing		
Connection data solid/stranded/AWG				
Input side		0.5 ... 4 mm ² / 0.5 ... 4 mm ² / 20 - 10		
Output side		0.5 ... 4 mm ² / 0.5 ... 4 mm ² / 20 - 10		
Dimensions	W / H / D	44 mm / 96 mm / 91 mm		
EMC note		Class A product, see page 583		

Ordering data

Description	Input voltage U_N	Type	Order No.	Pcs./Pkt.
Pre-assembled coupling relay modules with power contact relay and screw connection	① 24 V DC	RIF-4-RSC-LDP-24DC/2X21	2903291	5
	② 120 V AC	RIF-4-RSC-LV-120AC/2X21	2903290	5
	③ 230 V AC	RIF-4-RSC-LV-230AC/2X21	2903289	5



3 changeover-contact high-power relay module with screw connection

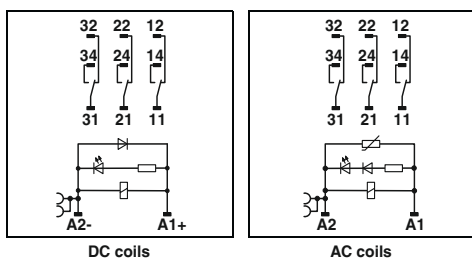

Technical data

①	②	③
See diagram		
56	24	14
20	5 - 25	5 - 25
20	5 - 20	5 - 20
Yellow LED, Varistor		
Yellow LED, damping diode		

3 PDTs
AgNi
440 V AC / 250 V DC
10 V (at 24 mA)
10 A (see diagram)
50 A (20 ms, N/O contact)
50 A (20 ms, N/O contact)
10 mA (at 24 V)

2500 VA
4,000 VA
1/3 HP, 120 V AC (single-phase AC motor)
1/2 HP, 240 V AC (single-phase AC motor)
1/2 HP, 240 V AC (three-phase induction motor)

2.5 kV_{rms} (50 Hz, 1 min.)
-40°C ... 40°C
-40°C ... 60°C
100% operating factor
Approx. 10⁷ cycles
Approx. 10⁷ cycles
DIN EN 50178
2 / III

Any / in rows with zero spacing

0.5 ... 4 mm² / 0.5 ... 4 mm² / 20 - 10
0.5 ... 4 mm² / 0.5 ... 4 mm² / 20 - 10
44 mm / 96 mm / 91 mm
Class A product, see page 583

Ordering data

Type	Order No.	Pcs./Pkt.
RIF-4-RSC-LDP-24DC/3X21	2903288	5
RIF-4-RSC-LV-120AC/3X21	2903287	5
RIF-4-RSC-LV-230AC/3X21	2903285	5

RIF-4-RSC.../2X21 (2 changeover contacts)

Operating voltage range

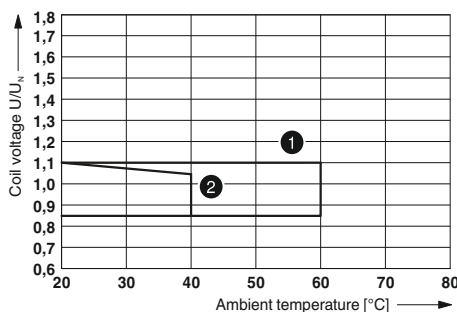

- ① DC coil (observe contact derating)
- ② AC coil (observe contact derating)

Interrupting rating

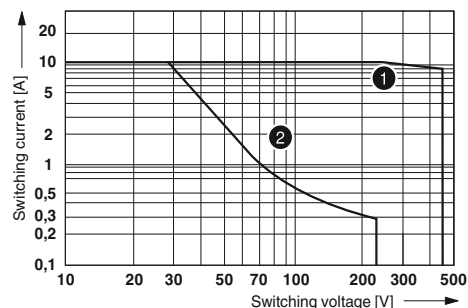

- ① AC, ohmic load
- ② DC, ohmic load

Contact derating

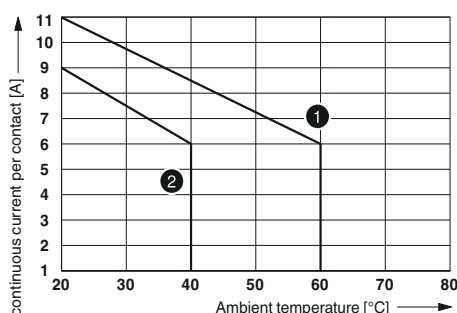

- ① DC coil
- ② AC coil

Electrical service life

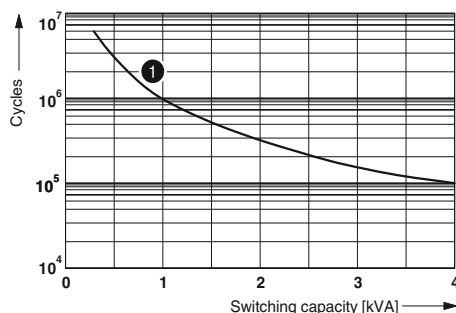

- ① 250 V AC, ohmic load

RIF-4-RSC.../3X21 (3 changeover contacts)

Operating voltage range

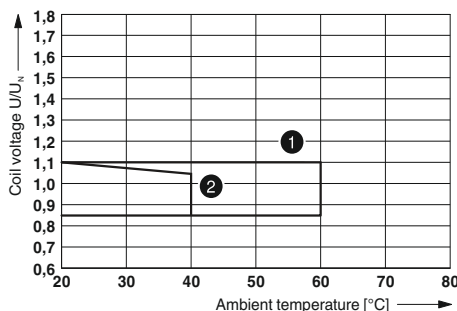

- ① DC coil (observe contact derating)
- ② AC coil (observe contact derating)

Interrupting rating

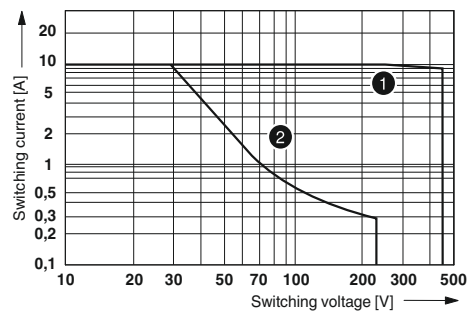

- ① AC, ohmic load
- ② DC, ohmic load

Contact derating

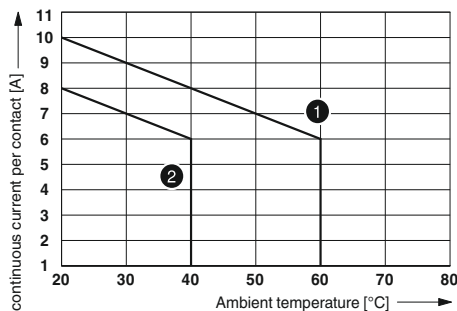

- ① DC coil
- ② AC coil

Electrical service life

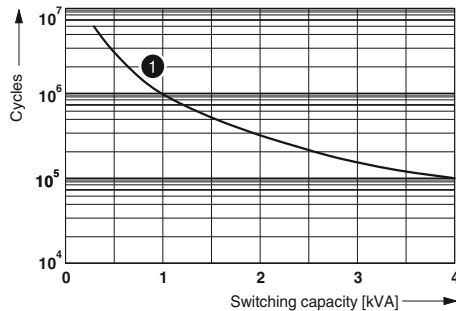

- ① 250 V AC, ohmic load

Fully mounted RIF-4 relay modules

Fully mounted RIF-4 relay modules, consisting of:

- Relay base with screw connection
- 3-N/O high-power relay
- Relay retaining bracket
- Varistor interference suppression module (AC types only)

The advantages:

- Logical contact arrangement, thanks to 1/3-level relay base
- Full shutdown by means of ≥ 3 mm contact opening
- Professional bridging of adjacent modules saves wiring time
- For FBS 2-6 plug-in bridges for the input side (A2), see page 358



3-N/O-contact high-power relay module with screw connection

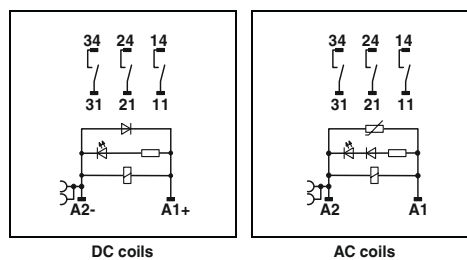

DC coils

AC coils

Technical data

		①	②	③
Input data		See diagram		
Permissible range (with reference to U_N)		70	24	14
Typical input current at U_N	[mA]	20	5 - 25	5 - 25
Typical response time at U_N	[ms]	20	5 - 20	5 - 20
Typical release time at U_N	[ms]			
Input circuit AC		Yellow LED, Varistor		
Input circuit DC		Yellow LED, damping diode		
Output data		3 N/O contacts		
Contact type		AgNi		
Contact material		440 V AC / 250 V DC		
Max. switching voltage		10 V (at 24 mA)		
Minimum switching voltage		10 A (see diagram)		
Limiting continuous current		50 A (20 ms, N/O contact)		
Maximum switch-on current AC		50 A (20 ms, N/O contact)		
Maximum switch-on current DC		10 mA (at 24 V)		
Minimum switching current				
Maximum interrupting rating, ohmic load		250 V AC	2500 VA	
		440 V AC	4,000 VA	
Motor load in accordance with UL 508		1/3 HP, 120 V AC (single-phase AC motor)		
		1/2 HP, 240 V AC (single-phase AC motor)		
		1/2 HP, 240 V AC (three-phase induction motor)		
General data		2.5 kV _{rms} (50 Hz, 1 min.)		
Test voltage (winding/contact)		-40°C ... 40°C		
Ambient temperature (operation), AC		-40°C ... 60°C		
Ambient temperature (operation), DC		100% operating factor		
Nominal operating mode		Approx. 10 ⁷ cycles		
Mechanical service life, AC		Approx. 10 ⁷ cycles		
Mechanical service life, DC		DIN EN 50178		
Standards/regulations		2 / III		
Degree of pollution/surge voltage category				
Mounting position/mounting		Any / in rows with zero spacing		
Connection data solid/stranded/AWG				
Input side		0.5 ... 4 mm ² / 0.5 ... 4 mm ² / 20 - 10		
Output side		0.5 ... 4 mm ² / 0.5 ... 4 mm ² / 20 - 10		
Dimensions	W / H / D	44 mm / 96 mm / 91 mm		
EMC note		Class A product, see page 583		

Ordering data

Description	Input voltage U_N	Type	Order No.	Pcs./Pkt.
Pre-assembled coupling relay modules with power contact relay and screw connection	① 24 V DC	RIF-4-RSC-LDP-24DC/3X1	2903284	5
	② 120 V AC	RIF-4-RSC-LV-120AC/3X1	2903283	5
	③ 230 V AC	RIF-4-RSC-LV-230AC/3X1	2903282	5

RIF-4-RSC.../3X1 (3 N/O contacts)

Operating voltage range

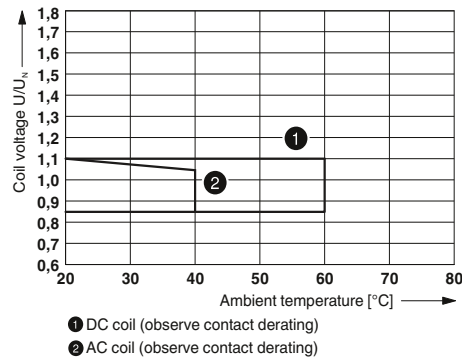

Interrupting rating

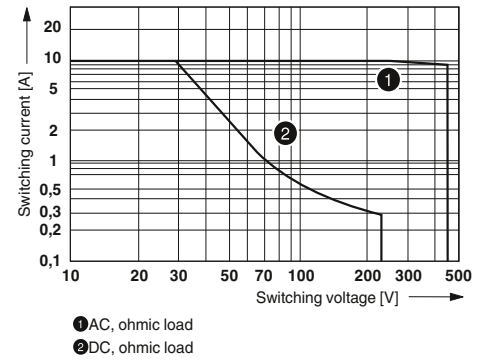

Contact derating

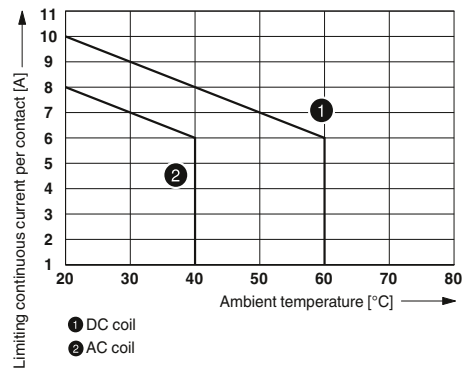

Electrical service life

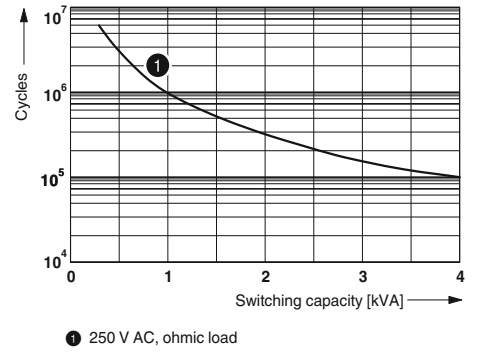

Relay modules

RIFLINE complete – Industrial relay system

RIFLINE complete accessories

Plug-in bridges

The plug-in bridges can be used for simple potential distribution via all relay bases.

The end clamp is used for safe isolation between adjacent modules and to visually separate the various function groups.



Plug-in bridge



End clamp

		Ordering data			Ordering data		
Description	Color	Type	Order No.	Pcs./Pkt.	Type	Order No.	Pcs./Pkt.
Plug-in bridge							
2-pos. red, 32 A		FBS 2-6	3030336	50			
2-pos. blue, 32 A		FBS 2-6 BU	3036932	50			
2-pos. gray, 32 A		FBS 2-6 GY	3032237	50			
5-pos. red, 32 A		FBS 5-6	3030349	50			
10-pos. red, 32 A		FBS 10-6	3030271	10			
20-pos. red, 32 A		FBS 20-6	3030365	10			
50-pos. red, 32 A		FBS 50-6	3032224	10			
2-pos. red, 41 A		FBS 2-8	3030284	10			
2-pos. blue, 41 A		FBS 2-8 BU	3032567	10			
2-pos. gray, 41 A		FBS 2-8 GY	3032541	10			
End clamp , to snap on NS 35, 9.5 mm wide, can be labeled with ZB 6, ZB 8/27, KLM...		7042			CLIPFIX 35	3022218	50

RIFLINE complete accessories

Marking material

The ZB zack band system offers numerous marking options that can be attached directly to the relay retaining brackets. In addition, further markings can be fixed to the relay base by means of double marker carriers.

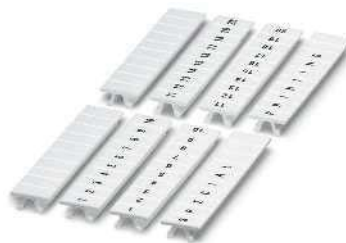

5.2 mm, 6.2 mm, and 15.2 mm wide



Double marker carrier

		Ordering data			Ordering data		
Description	Color	Type	Order No.	Pcs./Pkt.	Type	Order No.	Pcs./Pkt.
Zack marker strip, unprinted							
10-section	white	ZB 5 :UNBEDRUCKT	1050004	10			
10-section	white	ZB 6:UNBEDRUCKT	1051003	10			
5-section	white	ZB 15:UNBEDRUCKT	0811972	10			
Double marker carrier for ZB 5					STP 5-2	0800967	100
	gray						

RIFLINE complete accessories

Test plugs

The two-piece test plug offers individual plug color combinations. It is inserted directly in the function shaft of the Push-in connection.



2.3 mm test plug

		Ordering data		
Description	Color	Type	Order No.	Pcs./Pkt.
Test plug, consisting of:				
Metal part for 2.3 mm Ø socket hole and	gray	MPS-MT	0201744	10
Insulating sleeve , for MPS metal part	red	MPS-IH RD	0201676	10
	white	MPS-IH WH	0201663	10
	blue	MPS-IH BU	0201689	10
	yellow	MPS-IH YE	0201692	10
	green	MPS-IH GN	0201702	10
	gray	MPS-IH GY	0201728	10
	black	MPS-IH BK	0201731	10

Adapter for RIFLINE complete RF-1

RIF-1-V8... is the VARIOFACE adapter which connects the RIF-1 relay module with the VARIOFACE system cabling. This allows easy connection of eight relay modules to a controller.

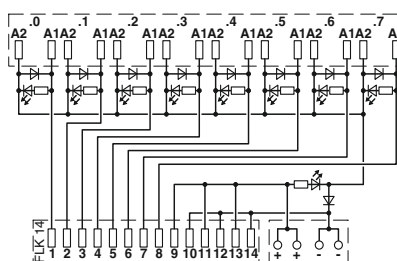

VARIOFACE adapter for RIFLINE complete RIF-1

		Technical data			
Maximum permissible operating voltage		30 V DC			
Maximum permissible current (per branch)		1 A (per signal path)			
Maximum total current (voltage supply)		3 A			
Rated surge voltage		0.6 kV (functional insulation)			
Ambient temperature (operation)		-40°C ... 60°C			
Mounting position		Any			
Standards/regulations		IEC 60664, DIN EN 50178			
Connection method	Controller level	IDC/FLK pin strip			
	Supply	Push-in connection			
Connection data solid/stranded/AWG		0.2 ... 1.5 mm ² / 0.2 ... 1.5 mm ² / 24 - 16			
Dimensions	H / D	101 mm / 75 mm			
		Ordering data			
Description	No. of pos.	Module width W	Type	Order No.	Pcs./Pkt.
V8 adapter , for eight RIF-1 relay modules, with IDC/FLK pin strip for PLC system cabling, positive switching					
	14	128 mm	RIF-1-V8/PT/FLK14/OUT	2905195	1

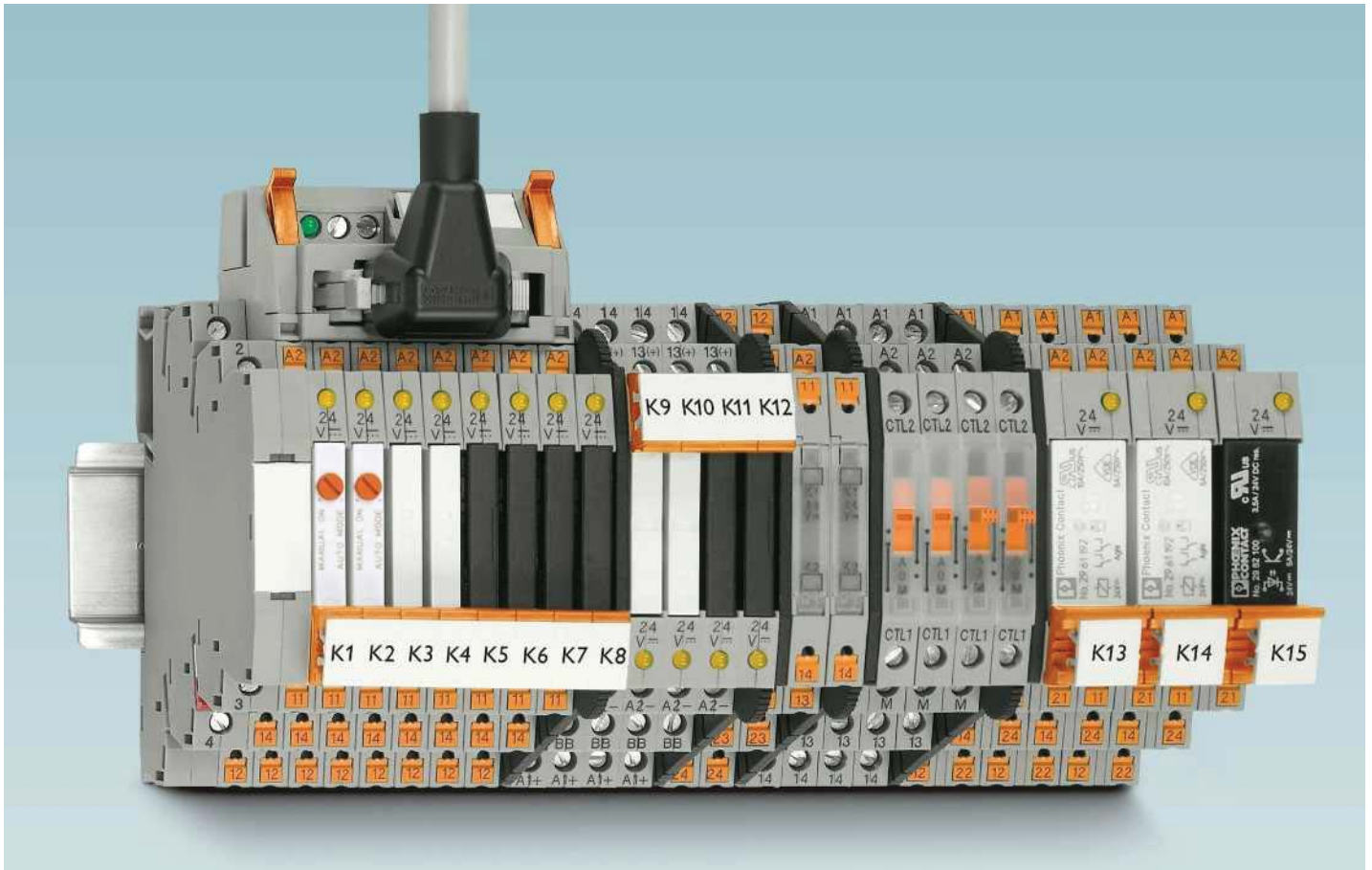

The PLC-INTERFACE relay system is the interface between the controller and system I/O devices.

The universal design is compact and space-saving. While the narrow 6.2 mm module has one contact, the 14 mm version is available with two contacts. The modules can be equipped with either an electromechanical or a solid-state relay.

They are protected against environmental influences by RTIII (IP67). The relays also offer safe isolation in accordance with DIN EN 50178 (VDE 0160).

PLC-INTERFACE is available in three connection technologies. Depending on the usage range, screw or Push-in connection can be selected.

In addition to the universal types, PLC-INTERFACE is also available in numerous special versions. These include:

- Sensor and actuator modules that can accommodate all connections directly on the interface
- Modules for high inrush or continuous currents
- Railway modules, which meet specific railway requirements
- Filter modules, which filter out interference on the input side

Plug-in bridges are available for all modules for simple potential distribution. In addition, solutions from system cabling applications offer easy connection to the plant control system. VARIOFACE adapters can be used to reduce wiring effort considerably. Installation is simplified significantly thanks to the integrated input and protective circuit.

Standard marking material from CLIPLINE complete modular terminal blocks can be used to mark PLC-INTERFACE.



Universal modules

PLC-R... and PLC-O... relay and solid-state relay modules with PDT or N/O contact, designed for universal use. Available in an overall width of 6.2 mm with one contact or in 14 mm with two contacts.

Available either with screw or Push-in connection.



Sensors/actuators

PLC...SEN and PLC...ACT offer space-saving sensor and actuator wiring without additional supply or output terminal blocks. The sensor or actuator connections are incorporated directly at the relay module.

Available either with screw or Push-in connection.



High currents

PLC...IC is particularly suitable for applications with high switch-on currents, e.g. from lamp loads. The PLC...HC relay modules are designed for applications with high continuous currents.

Available either with screw or Push-in connection.



Railway applications

PLC...RW relay or solid-state relay modules are suitable for railway requirements. These cover, for example, the extended temperature and input voltage range of railway applications.



Interference signals on the input side

PLC-B...SO46 basic terminal blocks are used for filtering interference currents and interference voltages on the input side.

Available either with screw or Push-in connection.



Accessories

The entire PLC-INTERFACE system can be extended by a range of accessories such as power terminals, adapters for system cabling or bridges for distribution of potential.

Product overview

Highly compact relay modules – Special versions and accessories

			Page	Web code
Actuator series		PLC-R.../1/ACT Assembled with a plug-in power contact relay	374	#0618
		PLC-R.../1IC/ACT Assembled with a plug-in miniature relay for high inrush currents	382	
		PLC-O.../24DC/2/ACT Assembled with a plug-in solid-state power relay	376	
		PLC-OSC.../230AC/1/ACT Assembled with a plug-in solid-state power relay	377	
Sensor series		PLC-R.../1AU/SEN Assembled with a plug-in relay for small switching capacities, with gold-plated multi-layer contact	380	#0617
		PLC-O.../48DC/100/SEN Assembled with a plug-in solid-state input relay	381	
Filter series		PLC-B...UC/21/SO46 For assembly with electromechanical or solid-state relays	388	#0689
		PLC-B...UC/1/SEN/SO46 For assembly with electromechanical or solid-state relays	389	
		PLC-BSC...UC/21-21/SO46 For assembly with relays	389	
		PLC-BSC...UC/21/HC/SO46 For assembly with relays	389	
Switch modules		PLC-RS...-24UC/1/S... Relay and switch integrated	406	#0898
		PLC-S...-S/... Switch integrated	407	
Solid-state relays		PLC-O.../24DC/... Optocoupler modules for universal use	372	#0899
		PLC-O.../230AC/... Switching capacity up to 230 V AC and 2.4 A in 6.2 mm	410	
		PLC-O.../300DC/... DC voltage output up to 300 V DC	408	
Ex relays		PLC-R.../21/EX 1 changeover contact with power contact	386	#0690
		PLC-R.../21-21/EX 2 changeover contacts with power contact	386	
		PLC-R.../21/HC/EX 1 changeover contact up to 10 A	387	
		PLC-O...C1D2 DC voltage output	387	

Hybrid solid-state relays	PLC-INTERFACE for railway applications	PLC-INTERFACE for high inrush currents	Reversing load relays
<p>PLC-H...24DC/230AC/10 Hybrid solid-state relays with AC voltage output, max. 10 A</p> <p>Page: 385 Web code: #0691</p>	<p>PLC.../RW Relay modules with extended input voltage and temperature range, specifically designed for use in railway applications</p> <p>Page: 418 Web code: #0900</p>	<p>PLC...1IC/ACT Maximum inrush current of 130 A, suitable for capacitive loads, available with screw and Push-in connection technology</p> <p>Page: 382 Web code: #0901</p>	<p>PLC-S...-ELR W 1/2-24DC Electronic reversing load relay for motors up to 24 V DC / 2 A</p> <p>Page: 423 Web code: #0693</p>

Accessories			Web code: #0692 Page: 426
	<p>Continuous plug-in bridge 500 mm long, insulated, can be cut to length, for potential distribution with PLC-INTERFACE</p>	<p>Plug-in bridge 2-pos., 6 mm long, bridges potentials of adjacent PLC-INTERFACE devices</p>	<p>Plug-in bridge 2-pos., 8 mm long, bridges potentials of adjacent PLC-INTERFACE devices with separating plate</p>
	<p>Plug-in bridge 2-pos., for connecting adjacent connections on a 14 mm PLC-INTERFACE device</p>	<p>Separating plate 2 mm thick, required at the start and end of every PLC terminal strip</p>	
			<p>Power terminal For supplying up to four potentials</p>

Logic modules			Web code: #0694 Page: 430
	<p>PLC-V8C.../SAM2 Stand-alone module With 16 I/Os, cannot be extended, connection to PC via micro USB socket. Integrated real-time clock, accommodates external IFS-CONFSTICK memory module.</p>	<p>PLC-V8C.../BM2 Basic module With 16 I/Os, can be extended up to a maximum of 48 I/Os. Connection to PC via micro USB socket. Integrated real-time clock. Accommodates external IFS-CONFSTICK memory module. Optional connection to IFS gateways.</p>	<p>PLC-V8C.../EM Extension module With 16 I/Os, for extending the basic module. A maximum of two extension modules can be connected to each basic module.</p>

System cabling adapters for PLC-INTERFACE			Web code: #0897 Page: 427
	<p>PLC-V8/FLK14... For 6.2 mm relay, with 14-pos. IDC/FLK pin strip, module width: 49.6 mm</p>	<p>PLC-V8/D15S/... For 6.2 mm relay, with 15-pos. D-SUB socket strip, module width: 49.6 mm</p>	<p>PLC-V8L/FLK14/... For 14 mm relay, with 14-pos. IDC/FLK pin strip, module width: 112.3 mm</p>

PLC-INTERFACE – Highly-compact relay modules

Universal PLC series with changeover contact relay

PLC-R... is the relay series that can be used universally and consists of basic terminal blocks and plug-in relays with changeover contacts.

The advantages:

- Slim design
- Screw and Push-in connection technology
- Functional plug-in bridges
- Integrated input and interference suppression circuit
- High degree of protection, RT III (wash-proof), or RT II for relay with one changeover contact with manual operation
- Safe isolation in accordance with DIN EN 50178 between coil and contact
- Efficient connection to system cabling using V8 adapter

Notes:
Type of insulating housing: Polyamide PBT non-reinforced, color: gray.
Marking systems and mounting material See Catalog 3
Separating plate PLC-ATP must be installed for voltages larger than 250 V (L1, L2, L3) between identical terminal blocks in adjacent modules. Potential bridging is then carried out with FBST 8-PLC... or FBST 500....
If the specified maximum values for multi-layer contact relays are exceeded, the gold plating is destroyed. The maximum values of the power contact relay are then valid. This can result in a shorter service life than with a pure power contact.
For diagrams of operating voltage ranges, see page 399
Inflammability class V0 (UL 94)
See the website for more information on connection cross sections with ferrules.
¹⁾ 120 and 230 V types up to 55°C



1-changeover-contact relay module, 6 A, maximum

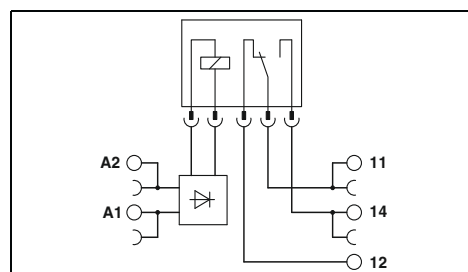

Input data	
Typical input current at U_N	[mA]
Response/release time at U_N	[ms]
Input circuit DC	
Input circuit AC/DC	
Output data	
Contact material	AgSnO
Max. switching voltage	250 V AC/DC
Minimum switching voltage	5 V (at 100 mA)
Limiting continuous current	6 A
Maximum switch-on current	10 A (4 s)
Minimum switching current	10 mA (at 12 V)
General data	
Test voltage input/output	4 kV AC (50 Hz, 1 min.)
Ambient temperature (operation)	-40°C ... 60°C ¹⁾
Mechanical service life	2x 10 ⁷ cycles
Standards/regulations	IEC 60664, EN 50178
Connection data solid/stranded/AWG	0.14 - 2.5 mm ² / 0.14 - 2.5 mm ² / 26 - 14
Dimensions	W / H / D 6.2 mm / 80 mm / 94 mm
EMC note	Class A product, see page 583

Technical data

①	②	③	④	⑤	⑥	⑦
15.3	9	11	9.2	4.8	3.5	3.2
5/8	5/8	6/15	5/8	5/8	6/15	7/15
Yellow LED, reverse polarity protection, free-wheeling diode						
Yellow LED, bridge rectifier						

AgSnO
250 V AC/DC
5 V (at 100 mA)
6 A
10 A (4 s)
10 mA (at 12 V)
4 kV AC (50 Hz, 1 min.)
-40°C ... 60°C ¹⁾
2x 10 ⁷ cycles
IEC 60664, EN 50178
0.14 - 2.5 mm ² / 0.14 - 2.5 mm ² / 26 - 14
6.2 mm / 80 mm / 94 mm
Class A product, see page 583

Ordering data

Description	Input voltage U_N	Type	Order No.	Pcs./Pkt.
PLC INTERFACE, with screw connection				
①	12 V DC	PLC-RSC- 12DC/21	2966906	10
②	24 V DC	PLC-RSC- 24DC/21	2966171	10
③	24 V AC/DC	PLC-RSC- 24UC/21	2966184	10
④	48 V DC	PLC-RSC- 48DC/21	2966113	10
⑤	60 V DC	PLC-RSC- 60DC/21	2966139	10
⑥	120 V AC / 110 V DC	PLC-RSC-120UC/21	2966197	10
⑦	230 V AC / 220 V DC	PLC-RSC-230UC/21	2966207	10
PLC-INTERFACE, with Push-in connection				
①	12 V DC	PLC-RPT- 12DC/21	2900316	10
②	24 V DC	PLC-RPT- 24DC/21	2900299	10
③	24 V AC/DC	PLC-RPT- 24UC/21	2900300	10
④	48 V DC	PLC-RPT- 48DC/21	2900301	10
⑤	60 V DC	PLC-RPT- 60DC/21	2900303	10
⑥	120 V AC / 110 V DC	PLC-RPT-120UC/21	2900304	10
⑦	230 V AC / 220 V DC	PLC-RPT-230UC/21	2900305	10

Electrical interrupting rating for PLC...21 with 1 PDT relay

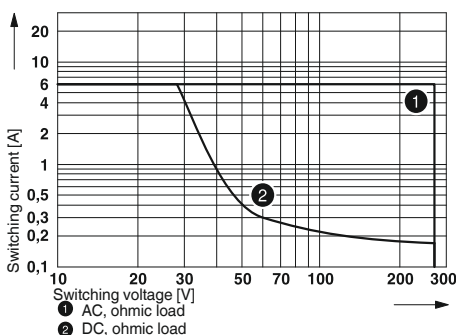



1-changeover-contact relay module,
50 mA, maximum



1-changeover-contact relay module
with manual operation, max. 6 A



1-changeover-contact relay module
with manual operation, max. 50 mA

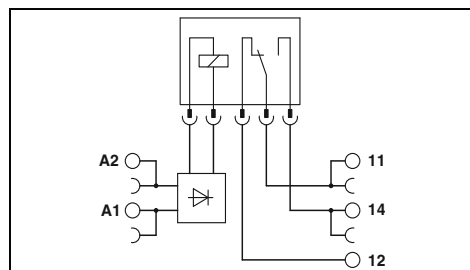
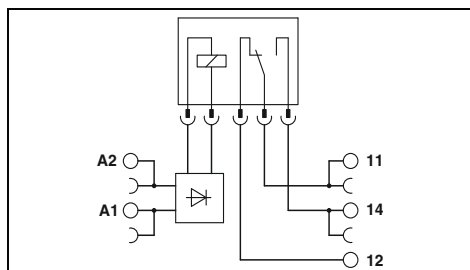
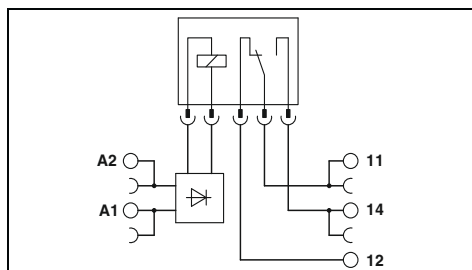

Technical data

①	②	③	④	⑤	⑥	⑦
15.3	9	11	9.2	4.8	3.5	3.2
5/8	5/8	6/15	5/8	5/8	6/15	7/15
Yellow LED, reverse polarity protection, free-wheeling diode						
Yellow LED, bridge rectifier						

AgSnO, hard gold-plated
30 V AC / 36 V DC
100 mV (at 10 mA)
50 mA
50 mA
1 mA (at 24 V)

4 kV AC (50 Hz, 1 min.)
-40°C ... 60°C)
2x 10⁷ cycles
IEC 60664, EN 50178
0.14 - 2.5 mm² / 0.14 - 2.5 mm² / 26 - 14
6.2 mm / 80 mm / 94 mm
Class A product, see page 583

Ordering data

Type	Order No.	Pcs./Pkt.
PLC-RSC- 12DC/21AU	2966919	10
PLC-RSC- 24DC/21AU	2966265	10
PLC-RSC- 24UC/21AU	2966278	10
PLC-RSC- 48DC/21AU	2966126	10
PLC-RSC- 60DC/21AU	2966142	10
PLC-RSC-120UC/21AU	2966281	10
PLC-RSC-230UC/21AU	2966294	10
PLC-RPT- 12DC/21AU	2900317	10
PLC-RPT- 24DC/21AU	2900306	10
PLC-RPT- 24UC/21AU	2900307	10
PLC-RPT- 48DC/21AU	2900308	10
PLC-RPT- 60DC/21AU	2900309	10
PLC-RPT-120UC/21AU	2900310	10
PLC-RPT-230UC/21AU	2900311	10

Technical data

①	②	③	⑥	⑦
15.3	9	11	3.5	3.2
5/8	5/8	6/15	6/15	7/15
Yellow LED				
Yellow LED, bridge rectifier				

AgSnO
250 V AC/DC
5 V (at 100 mA)
6 A
10 A (4 s)
10 mA (at 12 V)

4 kV AC (50 Hz, 1 min.)
-40°C ... 60°C
1x 10⁷ cycles
IEC 60664, EN 50178
0.14 - 2.5 mm² / 0.14 - 2.5 mm² / 26 - 14
6.2 mm / 80 mm / 94 mm
Class A product, see page 583

Ordering data

Type	Order No.	Pcs./Pkt.
PLC-RSC- 12DC/21/MS	2909648	10
PLC-RSC- 24DC/21/MS	2909649	10
PLC-RSC- 24UC/21/MS	2909650	10
PLC-RSC-120UC/21/MS	2909651	10
PLC-RSC-230UC/21/MS	2909653	10
PLC-RPT- 12DC/21/MS	2909666	10
PLC-RPT- 24DC/21/MS	2909667	10
PLC-RPT- 24UC/21/MS	2909668	10
PLC-RPT-120UC/21/MS	2909669	10
PLC-RPT-230UC/21/MS	2909670	10

Technical data

①	②	③	⑥	⑦
15.3	9	11	3.5	3.2
5/8	5/8	6/15	6/15	7/15
Yellow LED, reverse polarity protection, free-wheeling diode				
Yellow LED, bridge rectifier				

AgSnO, hard gold-plated
30 V AC / 36 V DC
100 mV (at 10 mA)
50 mA
50 mA
1 mA (at 24 V)

4 kV AC (50 Hz, 1 min.)
-40°C ... 60°C
2x 10⁷ cycles
IEC 60664, EN 50178
0.14 - 2.5 mm² / 0.14 - 2.5 mm² / 26 - 14
6.2 mm / 80 mm / 94 mm
Class A product, see page 583

Ordering data

Type	Order No.	Pcs./Pkt.
PLC-RSC- 12DC/21AU/MS	2909654	10
PLC-RSC- 24DC/21AU/MS	2909655	10
PLC-RSC- 24UC/21AU/MS	2909656	10
PLC-RSC-120UC/21AU/MS	2909657	10
PLC-RSC-230UC/21AU/MS	2909660	10
PLC-RPT- 12DC/21AU/MS	2909671	10
PLC-RPT- 24DC/21AU/MS	2909672	10
PLC-RPT- 24UC/21AU/MS	2909673	10
PLC-RPT-120UC/21AU/MS	2909674	10
PLC-RPT-230UC/21AU/MS	2909676	10

PLC-INTERFACE – Highly-compact relay modules

Universal PLC series with changeover contact relay

PLC-R... is the relay series that can be used universally and consists of basic terminal blocks and plug-in relays with changeover contacts.

The advantages:

- Slim design
- Screw and Push-in connection technology
- Functional plug-in bridges
- Integrated input and interference suppression circuit
- RT III sealed relay
- Safe isolation in accordance with DIN EN 50178 between coil and contact
- Efficient connection to system cabling using V8 adapter

Notes:	
Type of insulating housing:	Polyamide PBT non-reinforced, color: gray.
Marking systems and mounting material	See Catalog 3
Separating plate PLC-ATP must be installed for voltages larger than 250 V (L1, L2, L3) between identical terminal blocks in adjacent modules. Potential bridging is then carried out with FBST 8-PLC... or FBST 500....	
For diagrams of operating voltage ranges, see page 399	
Inflammability class V0 (UL 94)	
See the website for more information on connection cross sections with ferrules.	
¹⁾ 230 V types up to 55°C	
²⁾ If the specified maximum values are exceeded for multi-layer contact relays, the gold layer will be destroyed. During further use, the maximum values of the power contact relays apply. This may then result in a shorter service life than a dedicated power contact.	



2-changeover-contact relay module, 2 x 6 A, maximum

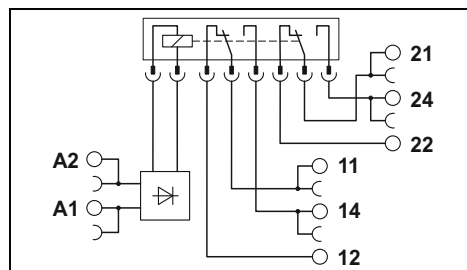

Input data	
Typical input current at U_N	[mA]
Response/release time at U_N	[ms]
Input circuit DC	
Input circuit AC/DC	
Output data	
Contact material	AgNi
Max. switching voltage	250 V AC/DC
Minimum switching voltage	5 V AC/DC (at 10 mA)
Limiting continuous current	6 A
Maximum switch-on current	15 A (300 ms)
Minimum switching current	10 mA (at 5 V)
General data	
Test voltage input/output	4 kV AC (50 Hz, 1 min.)
Ambient temperature (operation)	-40°C ... 60°C ¹⁾
Mechanical service life	3x 10 ⁷ cycles
Standards/regulations	IEC 60664, EN 50178
Connection data solid/stranded/AWG	0.14 - 2.5 mm ² / 0.14 - 2.5 mm ² / 26 - 14
Dimensions	14 mm / 80 mm / 94 mm
EMC note	Class A product, see page 583

Technical data						
①	②	③	④	⑤	⑥	⑦
33	18	17.5	20	10	4.5	4.5
8 / 10	8 / 10	8 / 10	8 / 10	8 / 10	7 / 10	7 / 10
Yellow LED, reverse polarity protection, free-wheeling diode						
Yellow LED, bridge rectifier						

Electrical interrupting rating for PLC...21-21 with 2 PDT relays

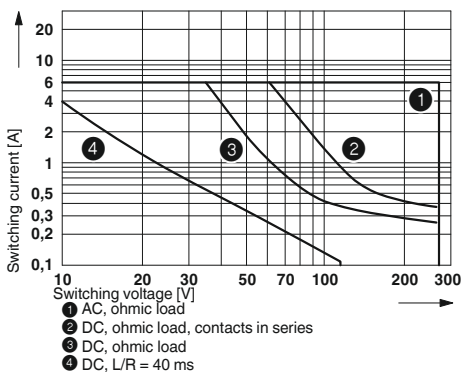

Description	Input voltage U_N
PLC INTERFACE, with screw connection	
①	12 V DC
②	24 V DC
③	24 V AC/DC
④	48 V DC
⑤	60 V DC
⑥	120 V AC / 110 V DC
⑦	230 V AC / 220 V DC
PLC-INTERFACE, with Push-in connection	
①	12 V DC
②	24 V DC
③	24 V AC/DC
④	48 V DC
⑤	60 V DC
⑥	120 V AC / 110 V DC
⑦	230 V AC / 220 V DC

Ordering data		
Type	Order No.	Pcs./Pkt.
PLC-RSC- 12DC/21-21	2967235	10
PLC-RSC- 24DC/21-21	2967060	10
PLC-RSC- 24UC/21-21	2967073	10
PLC-RSC- 48DC/21-21	2967248	10
PLC-RSC- 60DC/21-21	2967293	10
PLC-RSC-120UC/21-21	2967086	10
PLC-RSC-230UC/21-21	2967099	10
PLC-RPT- 12DC/21-21	2900329	10
PLC-RPT- 24DC/21-21	2900330	10
PLC-RPT- 24UC/21-21	2900332	10
PLC-RPT- 48DC/21-21	2900333	10
PLC-RPT- 60DC/21-21	2900334	10
PLC-RPT-120UC/21-21	2900335	10
PLC-RPT-230UC/21-21	2900336	10



2-changeover-contact relay module,
2 x 50 mA, maximum

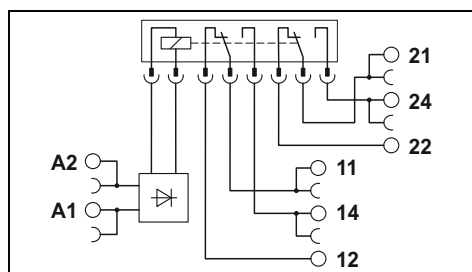

Technical data

①	②	③	④	⑤	⑥	⑦
33	18	17.5	20	10	4.5	4.5
8 / 10	8 / 10	8 / 10	8 / 10	8 / 10	7 / 10	7 / 10
Yellow LED, reverse polarity protection, free-wheeling diode						
Yellow LED, bridge rectifier						

AgNi, hard gold-plated
 30 V AC / 36 V DC
 100 mV (at 10 mA)
 50 mA²)
 50 mA²)
 1 mA (at 24 V)

4 kV AC (50 Hz, 1 min.)
 -40°C ... 60°C¹)
 3x 10⁷ cycles
 IEC 60664, EN 50178
 0.14 - 2.5 mm² / 0.14 - 2.5 mm² / 26 - 14
 14 mm / 80 mm / 94 mm
 Class A product, see page 583

Ordering data

Type	Order No.	Pcs./Pkt.
PLC-RSC- 12DC/21-21AU	2967277	10
PLC-RSC- 24DC/21-21AU	2967125	10
PLC-RSC- 24UC/21-21AU	2967112	10
PLC-RSC- 48DC/21-21AU	2967280	10
PLC-RSC- 60DC/21-21AU	2967303	10
PLC-RSC-120UC/21-21AU	2967138	10
PLC-RSC-230UC/21-21AU	2967141	10
PLC-RPT- 12DC/21-21AU	2900337	10
PLC-RPT- 24DC/21-21AU	2900338	10
PLC-RPT- 24UC/21-21AU	2900339	10
PLC-RPT- 48DC/21-21AU	2900340	10
PLC-RPT- 60DC/21-21AU	2900341	10
PLC-RPT-120UC/21-21AU	2900342	10
PLC-RPT-230UC/21-21AU	2900343	10

PLC-INTERFACE – Highly-compact relay modules

Universal PLC series with changeover contact relays with lockable manual operation

PLC-R... is the relay series that can be used universally and consists of a basic terminal block and plug-in relay with changeover contacts and lockable manual operation.

The advantages:

- Slim design
- Screw and Push-in connection technology
- Functional plug-in bridges
- Integrated input and interference suppression circuit
- Safe isolation in accordance with DIN EN 50178 between coil and contact
- Efficient connection to system cabling using V8 adapter

Notes:

See the website for more information on connection cross sections with ferrules.

If the specified maximum values for multi-layer contact relays are exceeded, the gold plating is destroyed. The maximum values of the power contact relay are then valid. This can result in a shorter service life than with a pure power contact.



new

Relay module with 2 changeover contacts with lockable manual operation, max. 2 x 6 A

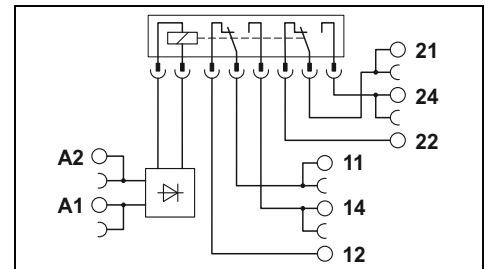

Electrical interrupting rating for PLC...21-21/MS with 2 PDT relays

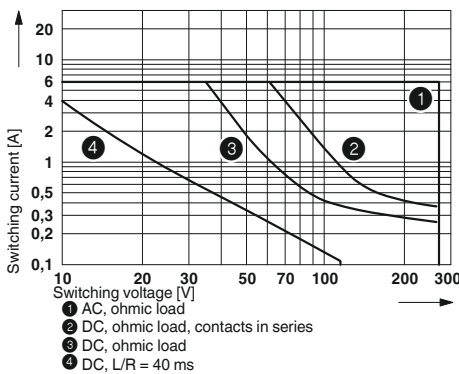

Electrical interrupting rating for PLC...21HC/MS with 1 PDT relay

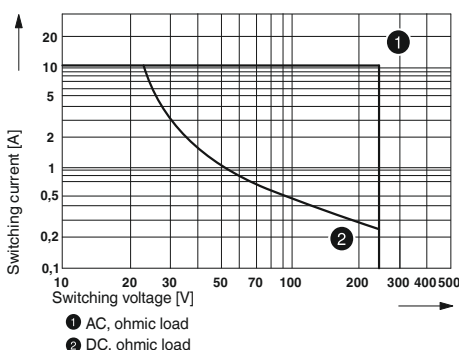

Input data

Typical input current at U_N	[mA]	18	18	19	5	5
Typical response time at U_N	[ms]	10	3 - 15	6	6	6
Typical release time at U_N	[ms]	10	3 - 15	10	10	10

Input circuit DC
Input circuit AC/DC

Output data

Contact material
Max. switching voltage
Minimum switching voltage
Limiting continuous current
Maximum switch-on current
Minimum switching current

General data

Test voltage input/output
Ambient temperature (operation)
Mechanical service life
Standards/regulations
Connection data solid/stranded/AWG
Dimensions
EMC note

①	②	③	④	⑤
18	18	19	5	5
10	3 - 15	6	6	6
10	3 - 15	10	10	10

Yellow LED, free-wheeling diode
Yellow LED, bridge rectifier

AgNi
250 V AC/DC
12 V (10 mA)
6 A
12 A (20 ms)
10 mA (12 V)

4 kV AC (50 Hz, 1 min.)
-20°C ... 60°C
5x 10⁶ cycles
EN 50178
0.14 - 2.5 mm² / 0.14 - 2.5 mm² / 26 - 14
14 mm / 80 mm / 104 mm
Class A product, see page 583

Description

PLC INTERFACE, with screw connection

	Input voltage U_N
①	24 V DC
②	24 V AC/DC
③	48 V DC
④	120 V AC / 110 V DC
⑤	230 V AC / 220 V DC

PLC-INTERFACE, with Push-in connection

	Input voltage U_N
①	24 V DC
②	24 V AC/DC
③	48 V DC
④	120 V AC / 110 V DC
⑤	230 V AC / 220 V DC

Technical data

Ordering data

Type	Order No.	Pcs./Pkt.
PLC-RSC- 24DC/21-21/MS	2910502	10
PLC-RSC- 24UC/21-21/MS	2910503	10
PLC-RSC- 48DC/21-21/MS	2910504	10
PLC-RSC-120UC/21-21/MS	2910505	10
PLC-RSC-230UC/21-21/MS	2910506	10
PLC-RPT- 24DC/21-21/MS	2910519	10
PLC-RPT- 24UC/21-21/MS	2910520	10
PLC-RPT- 48DC/21-21/MS	2910521	10
PLC-RPT-120UC/21-21/MS	2910522	10
PLC-RPT-230UC/21-21/MS	2910523	10



new



Relay module with 2 changeover contacts with lockable manual operation, max. 2 x 50 mA



new



Relay module with 1 changeover contact with lockable manual operation, max. 10 A

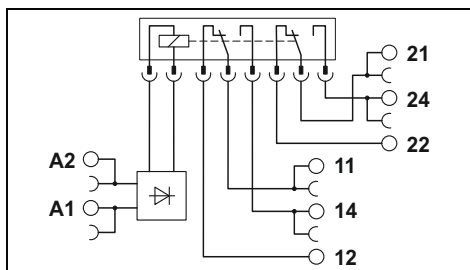

Technical data

①	②	③	④	⑤
18	18	19	5	5
10	3 - 15	6	6	6
10	3 - 15	10	10	10

Yellow LED, free-wheeling diode
Yellow LED, bridge rectifier

AgNi + Au
30 V AC / 36 V DC
12 V (1 mA)
50 mA
50 mA
1 mA (12 V)

4 kV AC (50 Hz, 1 min.)
-20°C ... 60°C
5x 10⁶ cycles
EN 50178
0.14 - 2.5 mm² / 0.14 - 2.5 mm² / 26 - 14
14 mm / 80 mm / 104 mm
Class A product, see page 583

Ordering data

Type	Order No.	Pcs./Pkt.
PLC-RSC- 24DC/21-21AU/MS	2910507	10
PLC-RSC- 24UC/21-21AU/MS	2910508	10
PLC-RSC- 48DC/21-21AU/MS	2910510	10
PLC-RSC-120UC/21-21AU/MS	2910511	10
PLC-RSC-230UC/21-21AU/MS	2910513	10
PLC-RPT- 24DC/21-21AU/MS	2910524	10
PLC-RPT- 24UC/21-21AU/MS	2910526	10
PLC-RPT- 48DC/21-21AU/MS	2910527	10
PLC-RPT-120UC/21-21AU/MS	2910528	10
PLC-RPT-230UC/21-21AU/MS	2910529	10

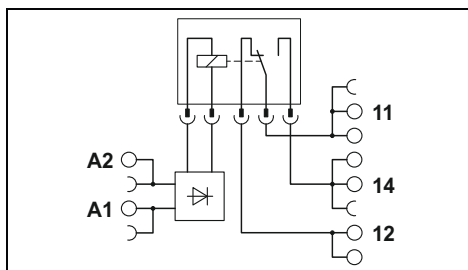

Technical data

①	②	③	④	⑤
18	18	19	5	5
10	3 - 15	6	6	6
10	3 - 15	10	8	8

Yellow LED, reverse polarity protection, free-wheeling diode
Yellow LED, bridge rectifier

AgNi
250 V AC/DC
12 V (10 mA)
10 A
24 A (20 ms)
10 mA (12 V)

4 kV_{rms} (50 Hz, 1 min.)
-20°C ... 60°C
5x 10⁶ cycles
EN 50178
0.14 - 2.5 mm² / 0.14 - 2.5 mm² / 26 - 14
14 mm / 80 mm / 104 mm
Class A product, see page 583

Ordering data

Type	Order No.	Pcs./Pkt.
PLC-RSC- 24DC/21HC/MS	2910514	10
PLC-RSC- 24UC/21HC/MS	2910515	10
PLC-RSC- 48DC/21HC/MS	2910516	10
PLC-RSC-120UC/21HC/MS	2910517	10
PLC-RSC-230UC/21HC/MS	2910518	10
PLC-RPT- 24DC/21HC/MS	2910530	10
PLC-RPT- 24UC/21HC/MS	2910531	10
PLC-RPT- 48DC/21HC/MS	2910532	10
PLC-RPT-120UC/21HC/MS	2910533	10
PLC-RPT-230UC/21HC/MS	2910534	10

PLC-INTERFACE – Highly-compact relay modules

PLC-INTERFACE with force-guided contacts

Fully assembled coupling relay module with pluggable relay with force-guided contacts, consisting of:

- Relay base with Push-in or screw connection
- 2-changeover-contact relay with force-guided contacts in accordance with EN 50205

The advantages:

- Switching current of up to 2x 6 A
- Forcibly guided contacts in accordance with EN 50205
- Professional bridging of adjacent modules
- Integrated status LED and freewheeling diode

The requirements for type A in accordance with DIN EN 50205 are satisfied if the circuit is designed as 1 N/O contact / 1 N/C contact.

Notes:

See the website for more information on connection cross sections with ferrules.



new

2 changeover-contact relay module with force-guided contacts

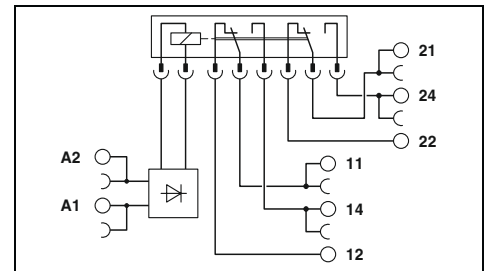

Technical data

	①	②
Input data		
Typical input current at U_N	[mA]	30 30
Typical response time at U_N	[ms]	10 3 - 15
Typical release time at U_N	[ms]	10 3 - 15
Input circuit DC		Yellow LED
Input circuit AC/DC		Yellow LED
Output data		
Contact material		AgNi
Max. switching voltage		250 V AC/DC
Minimum switching voltage		5 V (10 mA)
Limiting continuous current		6 A
Maximum switch-on current		6 A
Minimum switching current		10 mA (5 V)
General data		
Test voltage input/output		4 kV _{rms} (50 Hz, 1 min.)
Ambient temperature (operation)		-20°C ... 60°C
Mechanical service life		Approx. 10 ⁷ cycles
Standards/regulations		EN 50178
Connection data solid/stranded/AWG		0.14 - 2.5 mm ² / 0.14 - 2.5 mm ² / 26 - 14
Dimensions	W / H / D	14 mm / 80 mm / 104 mm
EMC note		Class A product, see page 583
Conformance/approvals		
Conformance		-
UL, USA		UL 508
UL, USA/Canada		cUL 508
UL, Canada		-

Ordering data

Description	Input voltage U_N	Type	Order No.	Pcs./Pkt.
PLC INTERFACE, with screw connection	① 24 V DC	PLC-RSC- 24DC/2X21/FG	2910535	10
	② 24 V AC/DC	PLC-RSC- 24UC/2X21/FG	2910536	10
PLC-INTERFACE, with Push-in connection	① 24 V DC	PLC-RPT- 24DC/2X21/FG	2910537	10
	② 24 V AC/DC	PLC-RPT- 24UC/2X21/FG	2910539	10

PLC-INTERFACE – Highly-compact relay modules

Universal PLC series with solid-state relays

PLC-O... is the solid-state relay series that can be used universally comprising basic terminal blocks and plug-in solid-state relays.

The advantages:

- Slim design
- Screw and Push-in connection technology
- Functional plug-in bridges
- Integrated input circuit
- RT-III sealed solid-state relays
- High switching capacity
- Zero voltage switch at AC output
- Efficient connection to system cabling using V8 adapter

Notes:	
Type of insulating housing: Polyamide PBT non-reinforced, color: gray.	
Marking systems and mounting material See Catalog 3	
Separating plate PLC-ATP must be installed for voltages larger than 250 V (L1, L2, L3) between identical terminal blocks in adjacent modules. Potential bridging is then carried out with FBST 8-PLC... or FBST 500....	
For derating curves see page 401	
See the website for more information on connection cross sections with ferrules.	



Solid-state relay module, DC output max. 100 mA

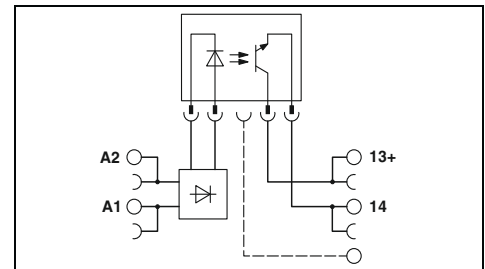

		Technical data					
		①	②	③	④	⑤	⑥
Input data		0.8 - 1.2					
Permissible range (with reference to U_N)		0.8 - 1.2	0.8 - 1.2	0.8 - 1.2	0.8 - 1.1	0.9 - 1.1	0.9 - 1.1
Switching level (with reference to U_N)	1 signal ("H")	≥ 0.8	≥ 0.8	≥ 0.8	≥ 0.8	≥ 0.9	≥ 0.8
	0 signal ("L")	≤ 0.4	≤ 0.3	≤ 0.4	≤ 0.4	≤ 0.3	≤ 0.3
Typical input current at U_N	[mA]	8.5	9	5	3	3.5	3.5
Typical switch-on time at U_N	[ms]	0.02	0.03	0.04	1	3	3
Typical switch-off time at U_N	[ms]	0.3	0.3	2	3	4	5
Transmission frequency f_{limit}	[Hz]	300	300	100	50	10	10
Input circuit DC		Yellow LED, reverse polarity protection, free-wheeling diode					
Input circuit AC/DC		Yellow LED, bridge rectifier					
Output data		48 V DC					
Max. switching voltage		3 V DC					
Minimum switching voltage		-					
Maximum switch-on current		-					
Minimum/maximum switching current		- / 100 mA					
Output protection		Reverse polarity protection, surge protection					
Voltage drop at maximum limiting continuous current		≤ 1 V					
Leakage current in off state		-					
Max. load value		-					
General data		2.5 kV (50 Hz, 1 min.)					
Test voltage input/output		-25°C ... 60°C					
Ambient temperature (operation)		IEC 60664, EN 50178					
Standards/regulations		2 / III					
Degree of pollution/surge voltage category		0.14 - 2.5 mm ² / 0.14 - 2.5 mm ² / 26 - 14					
Connection data solid/stranded/AWG		6.2 mm / 80 mm / 94 mm					
Dimensions	W / H / D	Class A product, see page 583					
EMC note							

		Ordering data		
Description	Input voltage U_N	Type	Order No.	Pcs./Pkt.
PLC INTERFACE, with screw connection				
①	24 V DC	PLC-OSC- 24DC/ 48DC/100	2966728	10
②	48 V DC	PLC-OSC- 48DC/ 48DC/100	2966993	10
③	60 V DC	PLC-OSC- 60DC/ 48DC/100	2967455	10
④	125 V DC	PLC-OSC-125DC/ 48DC/100	2980047	10
⑤	120 V AC / 110 V DC	PLC-OSC-120UC/ 48DC/100	2966744	10
⑥	230 V AC / 220 V DC	PLC-OSC-230UC/ 48DC/100	2966757	10
PLC-INTERFACE, with Push-in connection				
①	24 V DC	PLC-OPT- 24DC/ 48DC/100	2900352	10
②	48 V DC	PLC-OPT- 48DC/ 48DC/100	2900353	10
③	60 V DC	PLC-OPT- 60DC/ 48DC/100	2900354	10
⑤	120 V AC / 110 V DC	PLC-OPT-120UC/ 48DC/100	2900355	10
⑥	230 V AC / 220 V DC	PLC-OPT-230UC/ 48DC/100	2900356	10



Solid-state relay module,
DC output max. 3 A



Solid-state relay module,
AC output max. 750 mA

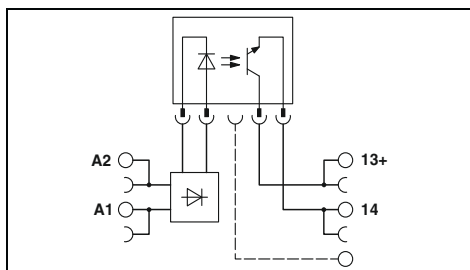

Technical data

①	②	③	④	⑤	⑥
0.8 - 1.2	0.8 - 1.2	0.8 - 1.2	0.8 - 1.1	0.9 - 1.1	0.9 - 1.1
≥0.8	≥0.8	≥0.8	≥0.8	≥0.8	≥0.8
≤0.4	≤0.4	≤0.3	≤0.3	≤0.3	≤0.3
8.5	9	5	3	3.5	3.5
0.02	0.03	0.04	0.04	3.5	4
0.3	0.3	0.5	0.6	7	7
300	300	100	100	10	10

Yellow LED, reverse polarity protection, free-wheeling diode
Yellow LED, bridge rectifier

33 V DC
3 V DC
15 A (10 ms)
- / 3 A (see derating curve)
Reverse polarity protection, surge protection
≤200 mV

-
-
2.5 kV (50 Hz, 1 min.)
-25°C ... 60°C
IEC 60664, EN 50178
2 / III

0.14 - 2.5 mm² / 0.14 - 2.5 mm² / 26 - 14
6.2 mm / 80 mm / 94 mm
Class A product, see page 583

Ordering data

Type	Order No.	Pcs./Pkt.
PLC-OSC- 24DC/ 24DC/ 2	2966634	10
PLC-OSC- 48DC/ 24DC/ 2	2967002	10
PLC-OSC- 60DC/ 24DC/ 2	2967468	10
PLC-OSC-125DC/ 24DC/ 2	2980050	10
PLC-OSC-120UC/ 24DC/ 2	2966650	10
PLC-OSC-230UC/ 24DC/ 2	2966663	10
PLC-OPT- 24DC/ 24DC/2	2900364	10
PLC-OPT- 48DC/ 24DC/2	2900365	10
PLC-OPT- 60DC/ 24DC/2	2900366	10
PLC-OPT-120UC/ 24DC/2	2900367	10
PLC-OPT-230UC/ 24DC/2	2900368	10

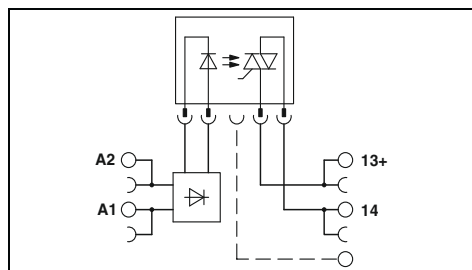

Technical data

①	②	③	④	⑤	⑥
0.8 - 1.2	0.8 - 1.2	0.8 - 1.2	0.8 - 1.1	0.9 - 1.1	0.8 - 1.1
≥0.8	≥0.8	≥0.8	≥0.8	≥0.8	≥0.8
≤0.25	≤0.25	≤0.3	≤0.3	≤0.25	≤0.25
8	9	6	3.5	4	3.5
10	10	10	10	10	10
10	10	10	10	10	10
10	10	10	10	3	3

Yellow LED, reverse polarity protection, free-wheeling diode
Yellow LED, bridge rectifier

253 V AC
24 V AC
30 A (10 ms)
10 mA / 0.75 A (see derating curve)
RCV circuit
<1 V

<1 mA (in off state)
4.5 A²s
2.5 kV (50 Hz, 1 min.)
-25°C ... 60°C
IEC 60664, EN 50178
2 / III

0.14 - 2.5 mm² / 0.14 - 2.5 mm² / 26 - 14
6.2 mm / 80 mm / 94 mm
Class A product, see page 583

Ordering data

Type	Order No.	Pcs./Pkt.
PLC-OSC- 24DC/230AC/ 1	2967840	10
PLC-OSC- 48DC/230AC/ 1	2967853	10
PLC-OSC- 60DC/230AC/ 1	2967866	10
PLC-OSC-125DC/230AC/ 1	2980063	10
PLC-OSC-120UC/230AC/ 1	2967879	10
PLC-OSC-230UC/230AC/ 1	2967882	10
PLC-OPT- 24DC/230AC/1	2900369	10
PLC-OPT- 48DC/230AC/1	2900370	10
PLC-OPT- 60DC/230AC/1	2900371	10
PLC-OPT-120UC/230AC/1	2900372	10
PLC-OPT-230UC/230AC/1	2900374	10

PLC-INTERFACE – Highly-compact relay modules

PLC actuator series for output functions

The PLC actuator series couples controllers and actuators such as motors, contactors, and valves.

The advantages:

- Direct connection of actuator to relay module including load return line
- No need for additional modular terminal blocks
- Space savings of up to 80%
- Time savings of up to 60%
- Screw and Push-in connection technology
- Relay modules with safe isolation in accordance with DIN EN 50178 between coil and contact
- Functional plug-in bridges
- Efficient connection to system cabling using V8 adapter

Notes:

Type of insulating housing: Polyamide PBT non-reinforced, color: gray.
Marking systems and mounting material See Catalog 3
Separating plate PLC-ATP must be installed for voltages larger than 250 V (L1, L2, L3) between identical terminal blocks in adjacent modules. Potential bridging is then carried out with FBST 8-PLC... or FBST 500....
For diagrams of operating voltage ranges, see page 399
For derating curves see page 401
See the website for more information on connection cross sections with ferrules.



1-N/O-contact relay module with additional floating terminal point

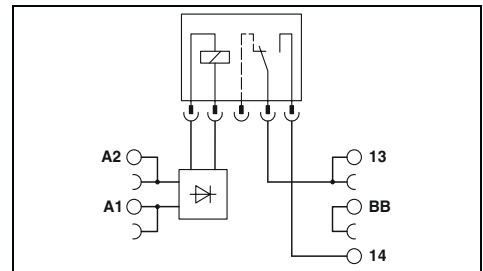

Electrical interrupting rating for PLC...24DC/1/ACT? with 1 N/O relay

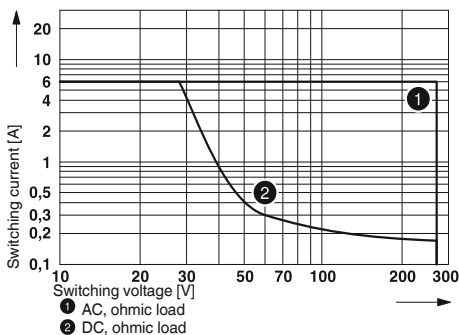

Electrical interrupting rating for PLC...24DC/1-1/ACT? with 2 N/O relays

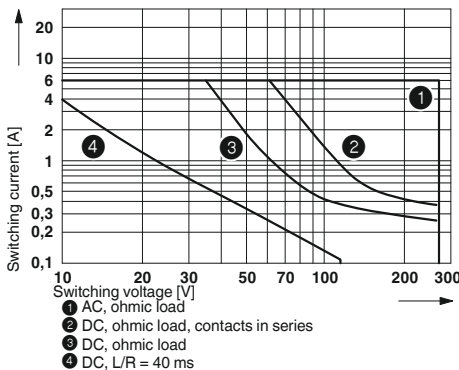

Input data

Permissible range (with reference to U_N)	
Typical input current at U_N	[mA]
Typical response time/switch-on time at U_N	[ms]
Typical release time/switch-off time at U_N	[ms]
Input circuit DC	

Output data

Contact material	
Max. switching voltage	
Minimum switching voltage	
Limiting continuous current	
Maximum switch-on current	
Minimum switching current	

General data

Test voltage input/output	
Ambient temperature (operation)	
Mechanical service life	
Standards/regulations	
Degree of pollution/surge voltage category	

Connection data solid/stranded/AWG

Dimensions	W / H / D
EMC note	

①

See diagram
9
5
8
Yellow LED, reverse polarity protection, free-wheeling diode

AgSnO

250 V AC/DC
5 V (at 100 mA)
6 A
10 A (4 s)
10 mA (at 12 V)

4 kV AC (50 Hz, 1 min.)
-40°C ... 60°C
2x 10 ⁷ cycles
IEC 60664, EN 50178
3 / III

0.14 - 2.5 mm² / 0.14 - 2.5 mm² / 26 - 14

6.2 mm / 80 mm / 94 mm
Class A product, see page 583

Ordering data

Description	Input voltage U_N
PLC INTERFACE, with screw connection	
①	24 V DC
PLC-INTERFACE, with Push-in connection	
①	24 V DC

Type	Order No.	Pcs./Pkt.
PLC-RSC- 24DC/ 1/ACT	2966210	10
PLC-RPT- 24DC/ 1/ACT	2900312	10



1-N/O-contact relay module with manual operation and additional floating terminal point



2-N/O-contact relay module with additional floating terminal points

ERC

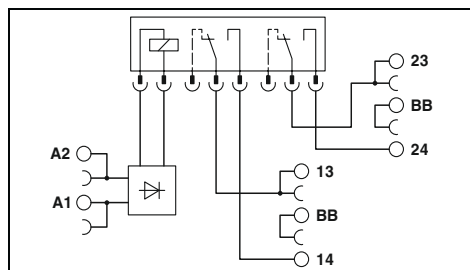
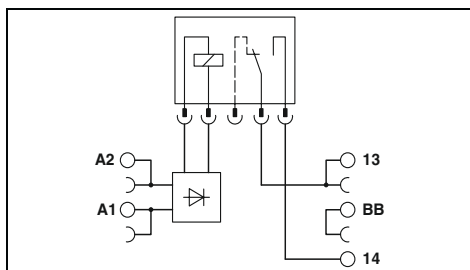

Technical data

①
See diagram
9
5
8
Yellow LED, reverse polarity protection, free-wheeling diode

AgSnO
250 V AC/DC
5 V (at 100 mA)
6 A
10 A (4 s)
10 mA (at 12 V)

4 kV AC (50 Hz, 1 min.)
-40°C ... 60°C
1x 10⁷ cycles
IEC 60664, EN 50178
3 / III

0.14 - 2.5 mm² / 0.14 - 2.5 mm² / 26 - 14
6.2 mm / 80 mm / 94 mm
Class A product, see page 583

Technical data

①
See diagram
18
8
10
Yellow LED, reverse polarity protection, free-wheeling diode

AgNi
250 V AC/DC
5 V AC/DC
6 A
8 A
10 mA

4 kV AC (50 Hz, 1 min.)
-40°C ... 60°C
3x 10⁷ cycles
IEC 60664, EN 50178
3 / III

0.14 - 2.5 mm² / 0.14 - 2.5 mm² / 26 - 14
14 mm / 80 mm / 94 mm
Class A product, see page 583

Ordering data

Type	Order No.	Pcs./Pkt.
PLC-RSC- 24DC/ 1/MS/ACT	2909661	10
PLC-RPT- 24DC/ 1/MS/ACT	2909677	10

Ordering data

Type	Order No.	Pcs./Pkt.
PLC-RSC- 24DC/ 1- 1/ACT	2967109	10

PLC-INTERFACE – Highly-compact relay modules

PLC actuator series for output functions

The PLC actuator series couples controllers and actuators such as motors, contactors, and valves.

The advantages:

- Direct connection of actuator to relay module including load return line
- No need for additional modular terminal blocks
- Space savings of up to 80%
- Time savings of up to 60%
- Screw and Push-in connection technology
- Relay modules with safe isolation in accordance with DIN EN 50178 between coil and contact
- Functional plug-in bridges
- Efficient connection to system cabling using V8 adapter

Notes:

See the website for more information on connection cross sections with ferrules.



Solid-state relay module with additional floating terminal point, DC output max. 3 A

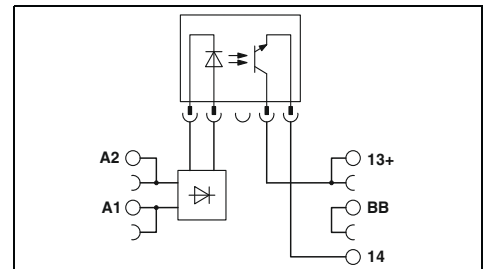

Technical data

		①	②
Input data			
Permissible range (with reference to U_N)		0.8 - 1.2	0.8 - 1.2
Switching level (with reference to U_N)		1 signal ("H") ≥ 0.8	≥ 0.8
		0 signal ("L") ≤ 0.25	≤ 0.4
Typical input current at U_N		[mA]	9.5 8.5
Typical response time/switch-on time at U_N		[ms]	0.02 0.02
Typical release time/switch-off time at U_N		[ms]	0.3 0.3
Transmission frequency f_{limit}		[Hz]	300 300
Input circuit DC		Yellow LED, reverse polarity protection, free-wheeling diode	
Output data			
Max. switching voltage		33 V DC	
Minimum switching voltage		3 V DC	
Limiting continuous current		3 A (see derating curve)	
Maximum switch-on current		15 A (10 ms)	
Minimum switching current		-	
Output protection		Reverse polarity protection, surge protection	
Voltage drop at maximum limiting continuous current		≤ 200 mV	
Leakage current in off state		-	
Phase angle ($\cos \phi$)		-	
Max. load value		-	
General data			
Test voltage input/output		2.5 kV (50 Hz, 1 min.)	
Ambient temperature (operation)		-25°C ... 60°C	
Standards/regulations		IEC 60664, EN 50178	
Degree of pollution/surge voltage category		2 / III	
Connection data solid/stranded/AWG		0.14 - 2.5 mm ² / 0.14 - 2.5 mm ² / 26 - 14	
Dimensions		W / H / D 6.2 mm / 80 mm / 94 mm	
EMC note		Class A product, see page 583	

Ordering data

Description	Input voltage U_N	Type	Order No.	Pcs./Pkt.
PLC INTERFACE, with screw connection	① 5 V DC	PLC-OSC- 5DC/ 24DC/ 2/ACT	2980144	10
	② 24 V DC	PLC-OSC- 24DC/ 24DC/ 2/ACT	2966676	10
PLC-INTERFACE, with Push-in connection	① 5 V DC	PLC-OPT- 5DC/ 24DC/2/ACT	2900375	10
	② 24 V DC	PLC-OPT- 24DC/ 24DC/2/ACT	2900376	10



**Solid-state relay module
with additional floating terminal point,
AC output max. 750 mA**

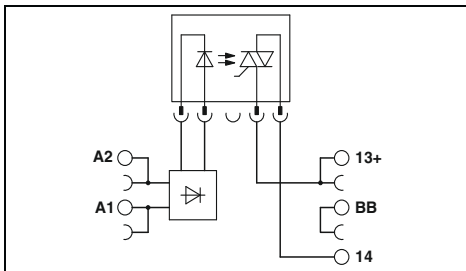

Technical data

Ⓢ
 0.8 -
 1.2
 ≥0.8
 ≤0.25
 9
 3
 9
 10
 Yellow LED, reverse polarity protection, free-wheeling diode
 253 V AC
 24 V AC
 0.75 A (see derating curve)
 30 A (10 ms)
 10 mA
 RCV circuit
 <1 V
 <1 mA (in off state)
 0.5
 4.5 A²s
 2.5 kV (50 Hz, 1 min.)
 -25°C ... 60°C
 IEC 60664, EN 50178
 2 / III
 0.14 - 2.5 mm² / 0.14 - 2.5 mm² / 26 - 14
 6.2 mm / 80 mm / 94 mm
 Class A product, see page 583

Ordering data

Type	Order No.	Pcs./Pkt.
PLC-OSC- 24DC/230AC/ 1/ACT	2967947	10

Relay modules

PLC-INTERFACE – Highly-compact relay modules

PLC actuator series for output functions

PLC actuator series with solid-state power relays for coupling the controller and actuators, such as motors, contactors, valves, etc.

Notes:
Type of insulating housing: Polyamide PBT non-reinforced, color: gray.
Marking systems and mounting material See Catalog 3
Separating plate PLC-ATP must be installed for voltages larger than 250 V (L1, L2, L3) between identical terminal blocks in adjacent modules. Potential bridging is then carried out with FBST 8-PLC... or FBST 500....
For derating curves see page 401
See the website for more information on connection cross sections with ferrules.



Solid-state relay module with additional floating terminal point, DC output max. 5 A

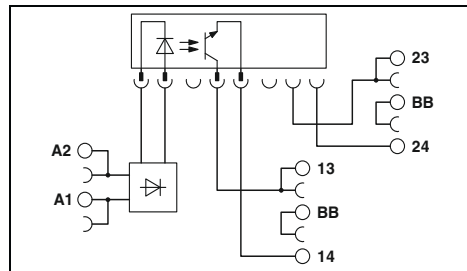

Technical data

Input data	①
Permissible range (with reference to U_N)	0.8 - 1.2
Switching level (with reference to U_N)	1 signal ("H") ≥ 0.8 0 signal ("L") ≤ 0.4
Typical input current at U_N	[mA] 9
Typical switch-on time at U_N	[ms] 0.02
Typical switch-off time at U_N	[ms] 0.4
Transmission frequency f_{limit}	[Hz] 300
Input circuit DC	Yellow LED, reverse polarity protection, free-wheeling diode
Output data	
Maximum/minimum switching voltage	33 V DC / 3 V DC
Maximum switch-on current	15 A (10 ms)
Minimum/maximum switching current	- / 5 A (see derating curve)
Output protection	Reverse polarity protection, surge protection
Voltage drop at maximum limiting continuous current	≤ 200 mV
Leakage current in off state	-
Phase angle (cos ϕ)	-
Max. load value	-
General data	
Rated insulation voltage	-
Rated surge voltage	Basic insulation
Ambient temperature (operation)	-20°C ... 60°C
Standards/regulations	IEC 60664, EN 50178
Degree of pollution/surge voltage category	2 / III
Mounting position/mounting	See to derating / in rows with zero spacing
Connection data solid/stranded/AWG	0.14 - 2.5 mm ² / 0.14 - 2.5 mm ² / 26 - 14
Dimensions	W / H / D 14 mm / 80 mm / 94 mm
EMC note	Class A product, see page 583

Ordering data

Description	Input voltage U_N	Type	Order No.	Pcs./Pkt.
PLC INTERFACE, with screw connection ①	24 V DC	PLC-OSC- 24DC/ 24DC/ 5/ACT	2982786	10



Solid-state relay module with additional floating terminal point, AC output max. 2 A

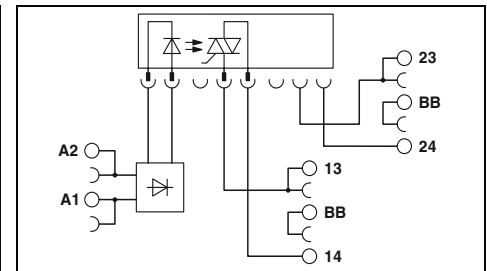

Technical data

Input data	①
Permissible range (with reference to U_N)	0.8 - 1.2
Switching level (with reference to U_N)	1 signal ("H") ≥ 0.8 0 signal ("L") ≤ 0.4
Typical input current at U_N	[mA] 9
Typical switch-on time at U_N	[ms] 10
Typical switch-off time at U_N	[ms] 10
Transmission frequency f_{limit}	[Hz] 10
Input circuit DC	Yellow LED, reverse polarity protection, free-wheeling diode
Output data	
Maximum/minimum switching voltage	253 V AC / 24 V AC
Maximum switch-on current	30 A (10 ms)
Minimum/maximum switching current	25 mA / 2 A (see derating curve)
Output protection	Surge protection
Voltage drop at maximum limiting continuous current	≤ 1 V
Leakage current in off state	Typically 1 mA
Phase angle (cos ϕ)	0.5
Max. load value	4 A ² s (tp = 10 ms, at 25°C)
General data	
Rated insulation voltage	-
Rated surge voltage	Basic insulation
Ambient temperature (operation)	-20°C ... 60°C
Standards/regulations	IEC 60664, EN 50178
Degree of pollution/surge voltage category	2 / III
Mounting position/mounting	See to derating / in rows with zero spacing
Connection data solid/stranded/AWG	0.14 - 2.5 mm ² / 0.14 - 2.5 mm ² / 26 - 14
Dimensions	W / H / D 14 mm / 80 mm / 94 mm
EMC note	Class A product, see page 583

Ordering data

Description	Input voltage U_N	Type	Order No.	Pcs./Pkt.
PLC INTERFACE, with screw connection ①	24 V DC	PLC-OSC- 24DC/230AC/ 2/ACT	2982760	10

PLC actuator series for output functions

PLC actuator basic terminal blocks that can be fitted with a mechanical or solid-state relay. For coupling the controller and actuators, such as motors, contactors, valves, etc.

Notes:
Maximum interrupting rating diagrams, see page 402
For derating curves see page 401
When mounting relays on a DIN rail base or PCB, data may be limited, especially with regard to the limiting continuous current and/or ambient temperature range. See "General" section in "Fundamentals of relay technology" on page 272
See the website for more information on connection cross sections with ferrules.
If the specified maximum values for multi-layer contact relays are exceeded, the gold plating is destroyed. The maximum values of the power contact relay are then valid. This can result in a shorter service life than with a pure power contact.



Basic terminal block with additional floating terminal point for assembly with relay



Basic terminal block with additional floating terminal point for assembly with solid-state relay

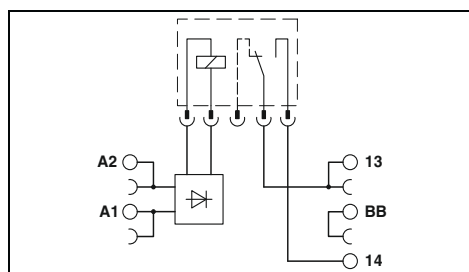

Technical data

Input data	
Permissible range (with reference to U _N)	0.8 ... 1.2
Typical input current at U _N (50/60 Hz)	15.6 mA / 8.5 mA
Typical response time at U _N	5 ms
Typical release time at U _N	30 ms
Input circuit	Yellow LED, bridge rectifier
Output data with:	REL-MR-24DC/21AU REL-MR-24DC/21
Contact type	Single contact, 1 N/O contact Single contact, 1 N/O contact
Contact material	AgSnO, hard gold-plated AgSnO
Max. switching voltage	30 V AC / 36 V DC 250 V AC/DC
Minimum switching voltage	100 mV (at 10 mA) 5 V (at 100 mA)
Limiting continuous current	50 mA 6 A
Minimum switching current	1 mA (at 24 V) 10 mA (at 12 V)
Output protection	- -
Voltage drop at limiting continuous current	- -
Leakage current in off state	- -
Max. load value I ² x t (t = 10 ms)	- -
General data	
Rated insulation voltage	250 V AC
Rated surge voltage/insulation	6 kV / safe isolation, increased insulation
Ambient temperature (operation)	-20°C ... 60°C
Air clearances and creepage distances	EN 50178
Degree of pollution/overvoltage category	2 / III
Connection data solid/stranded/AWG	0.14 - 2.5 mm ² / 0.14 - 2.5 mm ² / 26 - 14
Dimensions	6.2 mm / 80 mm / 94 mm

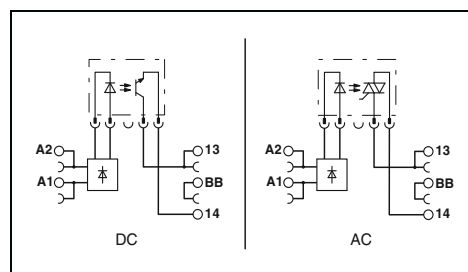

Technical data

Input data		
Permissible range (with reference to U _N)	0.8 ... 1.2	
Typical input current at U _N (50/60 Hz)	15 mA / 8.3 mA	
Typical response time at U _N	10 ms	
Typical release time at U _N	20 ms	
Input circuit	Yellow LED, bridge rectifier	
Output data with:	OPT...48DC/...	OPT...24DC/...
Contact type	-	-
Contact material	-	-
Max. switching voltage	48 V DC 33 V DC 253 V AC	
Minimum switching voltage	3 V DC 3 V DC 24 V AC	
Limiting continuous current	100 mA 3 A (see derating curve)	0.75 A (see derating curve)
Minimum switching current	-	-
Output protection	Reverse polarity protection, surge protection	RCV circuit
Voltage drop at limiting continuous current	≤1 V ≤150 mV ≤1 V	
Leakage current in off state	- - ≤1 mA	
Max. load value I ² x t (t = 10 ms)	- - 4.5 A ² s (tp = 10 ms, at 25°C)	
General data		
Rated insulation voltage	250 V AC	
Rated surge voltage/insulation	6 kV / safe isolation, increased insulation	
Ambient temperature (operation)	-20°C ... 60°C	
Air clearances and creepage distances	EN 50178	
Degree of pollution/overvoltage category	2 / III	
Connection data solid/stranded/AWG	0.14 - 2.5 mm ² / 0.14 - 2.5 mm ² / 26 - 14	
Dimensions	6.2 mm / 80 mm / 94 mm	

Ordering data

Description	Voltage U _N
PLC INTERFACE, with screw connection	24 V AC/DC
PLC-INTERFACE, with Push-in connection	24 V AC/DC

Type	Order No.	Pcs./Pkt.
PLC-BSC- 24UC/ 1/ACT	2982799	10
PLC-BPT- 24UC/ 1/ACT	2900450	10

Ordering data

Type	Order No.	Pcs./Pkt.
PLC-BSC- 24UC/ 1/ACT	2982799	10
PLC-BPT- 24UC/ 1/ACT	2900450	10

Accessories

Plug-in miniature power relays, with multi-layer gold contacts		
REL-MR- 24DC/21AU	2961121	10
REL-MR- 24DC/21	2961105	10
Pluggable solid-state relays		
Solid-state input relays		
Solid-state power relays		
Solid-state power relays		

REL-MR- 24DC/21AU	2961121	10
REL-MR- 24DC/21	2961105	10
OPT-24DC/ 48DC/100	2966618	10
OPT-24DC/ 24DC/ 2	2966595	10
OPT-24DC/230AC/ 1	2967950	10

PLC-INTERFACE – Highly-compact relay modules

PLC sensor series for input functions

PLC sensor series for coupling controller and sensors, such as proximity switches, limit switches or auxiliary contacts

The advantages:

- Direct connection of sensor to relay module including sensor supply
- No need for additional modular terminal blocks
- Space savings of up to 80%
- Time savings of up to 60%
- Screw and Push-in connection technology
- Relay modules with safe isolation in accordance with DIN EN 50178 between coil and contact
- Functional plug-in bridges
- Efficient connection to system cabling using V8 adapter

Notes:	
Type of insulating housing:	Polyamide PBT non-reinforced, color: gray.
Marking systems and mounting material	See Catalog 3
Separating plate PLC-ATP must be installed for voltages larger than 250 V (L1, L2, L3) between identical terminal blocks in adjacent modules. Potential bridging is then carried out with FBST 8-PLC... or FBST 500....	
For diagrams of operating voltage ranges, see page 399	
See the website for more information on connection cross sections with ferrules.	
1) 120 and 230 V types up to 55°C	
2) If the specified maximum values are exceeded for multi-layer contact relays, the gold layer will be destroyed. During further use, the maximum values of the power contact relays apply. This may then result in a shorter service life than a dedicated power contact.	



1-N/O-contact relay module with additional floating terminal point

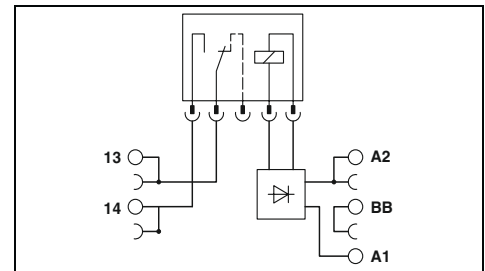

Technical data

Input data	①	②	③	
Permissible range (with reference to U_N)	See diagram			
Switching level (with reference to U_N)	1 signal ("H") 0 signal ("L")			
Typical input current at U_N	[mA]	9	3.5	3.2
Typical response time/switch-on time at U_N	[ms]	5	6	7
Typical release time/switch-off time at U_N	[ms]	8	15	15
Transmission frequency f_{limit}	[Hz]			
Input circuit DC	Yellow LED, reverse polarity protection, free-wheeling diode			
Input circuit AC/DC	Yellow LED, bridge rectifier			
Output data				
Contact material	AgSnO, hard gold-plated			
Max. switching voltage	30 V AC / 36 V DC			
Minimum switching voltage	100 mV (at 10 mA)			
Limiting continuous current	50 mA			
Maximum switch-on current	50 mA			
Minimum switching current	1 mA (at 24 V)			
Output protection	-			
Voltage drop at maximum limiting continuous current	-			
General data				
Test voltage input/output	4 kV AC (50 Hz, 1 min.)			
Ambient temperature (operation)	-40°C ... 60°C ¹⁾			
Mechanical service life	2x 10 ⁷ cycles			
Standards/regulations	IEC 60664, EN 50178			
Degree of pollution/surge voltage category	3 / III			
Connection data solid/stranded/AWG	0.14 - 2.5 mm ² / 0.14 - 2.5 mm ² / 26 - 14			
Dimensions	W / H / D 6.2 mm / 80 mm / 94 mm			
EMC note	Class A product, see page 583			

Ordering data

Description	Input voltage U_N	Type	Order No.	Pcs./Pkt.
PLC INTERFACE, with screw connection				
①	24 V DC	PLC-RSC- 24DC/ 1AU/SEN	2966317	10
②	120 V AC / 110 V DC	PLC-RSC-120UC/ 1AU/SEN	2966320	10
③	230 V AC / 220 V DC	PLC-RSC-230UC/ 1AU/SEN	2966333	10
PLC-INTERFACE, with Push-in connection				
①	24 V DC	PLC-RPT- 24DC/ 1AU/SEN	2900313	10
②	120 V AC / 110 V DC	PLC-RPT-120UC/ 1AU/SEN	2900314	10
③	230 V AC / 220 V DC	PLC-RPT-230UC/ 1AU/SEN	2900315	10



1-N/O-contact relay module with manual operation and additional floating terminal point



Solid-state relay module with additional floating terminal point, DC output max. 100 mA

ERC

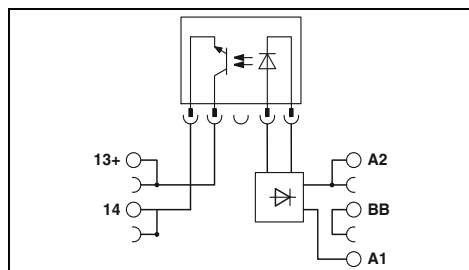
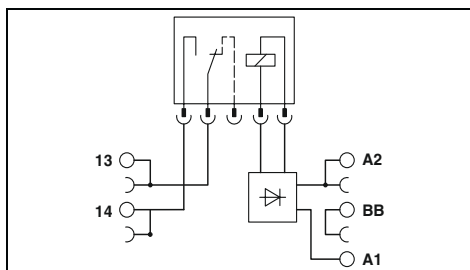

Technical data

① ② ③
See diagram

9	3.5	3.2
5	6	7
8	15	15

Yellow LED, reverse polarity protection, free-wheeling diode
Yellow LED, bridge rectifier

AgSnO, hard gold-plated
30 V AC / 36 V DC
100 mV (at 10 mA)
50 mA²
50 mA²
1 mA (at 24 V)
-
-

4 kV AC (50 Hz, 1 min.)
-40°C ... 60°C¹)
1x 10⁷ cycles
IEC 60664, EN 50178
3 / III

0.14 - 2.5 mm² / 0.14 - 2.5 mm² / 26 - 14
6.2 mm / 80 mm / 94 mm
Class A product, see page 583

Ordering data

Type	Order No.	Pcs./Pkt.
PLC-RSC- 24DC/ 1AU/MS/SEN	2909663	10
PLC-RSC-120UC/ 1AU/MS/SEN	2909664	10
PLC-RSC-230UC/ 1AU/MS/SEN	2909665	10
PLC-RPT- 24DC/ 1AU/MS/SEN	2909678	10
PLC-RPT-120UC/ 1AU/MS/SEN	2909679	10
PLC-RPT-230UC/ 1AU/MS/SEN	2909680	10

Technical data

①	②	③
0.8 - 1.2	0.8 - 1.1	0.8 - 1.1
≥0.8	≥0.8	≥0.8
≤0.4	≤0.3	≤0.3
8.5	3.5	3.5
0.02	6	3
0.3	10	5
300	10	10

Yellow LED, reverse polarity protection, free-wheeling diode
Yellow LED, bridge rectifier

-
48 V DC
3 V DC
100 mA
-
-
Reverse polarity protection, surge protection
≤1 V

2.5 kV (50 Hz, 1 min.)
-25°C ... 60°C
-
IEC 60664, EN 50178
2 / III

0.14 - 2.5 mm² / 0.14 - 2.5 mm² / 26 - 14
6.2 mm / 80 mm / 94 mm
Class A product, see page 583

Ordering data

Type	Order No.	Pcs./Pkt.
PLC-OSC- 24DC/ 48DC/100/SEN	2966773	10
PLC-OSC-120UC/ 48DC/100/SEN	2966799	10
PLC-OSC-230UC/ 48DC/100/SEN	2966809	10
PLC-OPT- 24DC/ 48DC/100/SEN	2900358	10
PLC-OPT-120UC/ 48DC/100/SEN	2900359	10
PLC-OPT-230UC/ 48DC/100/SEN	2900361	10

Relay modules

PLC-INTERFACE – Highly-compact relay modules

PLC-INTERFACE for high inrush currents, e.g., LEDs

PLC relay modules for high switch-on currents due, for example, to capacitive loads.

- The advantages:
- Maximum inrush current 130 A peak
 - Direct connection of load return line thanks to actuator type
 - Screw and Push-in connection technology
 - Safe isolation in accordance with DIN EN 50178 between coil and contact
 - Functional plug-in bridges
 - Efficient connection to system cabling using V8 adapter

Notes:
Type of insulating housing: Polyamide PBT non-reinforced, color: gray.
Marking systems and mounting material See Catalog 3
Separating plate PLC-ATP must be installed for voltages larger than 250 V (L1, L2, L3) between identical terminal blocks in adjacent modules. Potential bridging is then carried out with FBST 8-PLC... or FBST 500....
For diagrams of operating voltage ranges, see page 399
See the website for more information on connection cross sections with ferrules.



1-N/O-contact relay module with additional floating terminal point, max. 130 A peak

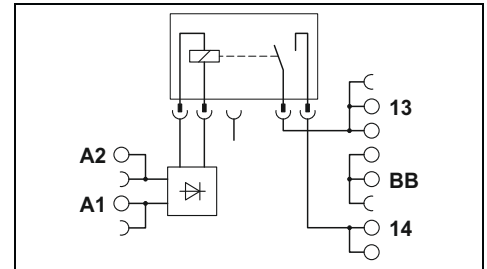

Basic behavior of capacitive loads:
- Very high input current
- Voltage increases with an e-function

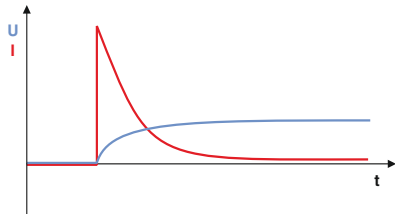

Maximum interrupting rating

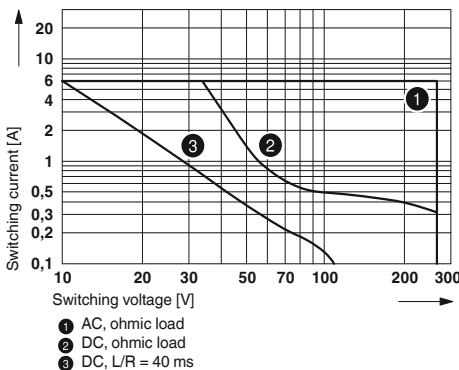

Input data	①	②
Typical input current at U_N	33	18
Response/release time at U_N	8 / 10	8 / 10
Input circuit DC	Yellow LED, reverse polarity protection, free-wheeling diode	
Output data		
Contact material	AgSnO	
Max. switching voltage	250 V AC/DC	
Minimum switching voltage	12 V (at 100 mA)	
Maximum switch-on current	80 A (for 20 ms) / 130 A (peak, at capacitive load, 230 V AC, 24 μ F)	
General data		
Test voltage input/output	4 kV AC (50 Hz, 1 min.)	
Ambient temperature (operation)	-40°C ... 60°C	
Mechanical service life	3x 10 ⁷ cycles	
Standards/regulations	EN 50178, EN 61810-1	
Connection data solid/stranded/AWG	0.14 - 2.5 mm ² / 0.14 - 2.5 mm ² / 26 - 14	
Dimensions	W / H / D 14 mm / 80 mm / 94 mm	

Technical data

Ordering data		
Type	Order No.	Pcs./Pkt.
PLC INTERFACE, with screw connection		
①	12 V DC	PLC-RSC- 12DC/ 11C/ACT 1078800
②	24 V DC	PLC-RSC- 24DC/ 11C/ACT 2967604
PLC-INTERFACE, with Push-in connection		
①	12 V DC	PLC-RPT- 12DC/ 11C/ACT 1078801
②	24 V DC	PLC-RPT- 24DC/ 11C/ACT 2900298

new

PLC-INTERFACE with tungsten lead contact relay

PLC-INTERFACE with tungsten lead contact relay, e.g., LEDs

The advantages:

- Maximum inrush current up to 800 A peak through tungsten lead contact
- Direct connection of load return line thanks to actuator type
- Screw and Push-in connection technology
- Safe isolation in accordance with DIN EN 50178 between coil and contact
- Functional plug-in bridges
- Efficient connection to system cabling using V8 adapter

Notes:	
Type of insulating housing:	Polyamide PBT non-reinforced, color: gray.
Marking systems and mounting material	See Catalog 3
Separating plate PLC-ATP must be installed for voltages larger than 250 V (L1, L2, L3) between identical terminal blocks in adjacent modules. Potential bridging is then carried out with FBST 8-PLC... or FBST 500....	
For diagrams of operating voltage ranges, see page 399	
See the website for more information on connection cross sections with ferrules.	



1-N/O-contact relay module with additional floating terminal point, 800 A peak, maximum

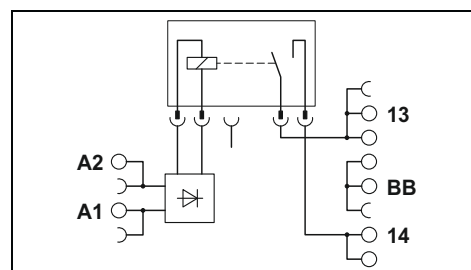

Technical data

Input data	①
Typical input current at U_N	18 [mA]
Response/release time at U_N	8 / 10 [ms]
Input circuit DC	Yellow LED, reverse polarity protection, free-wheeling diode
Input circuit AC/DC	
Output data	
Contact material	AgSnO
Max. switching voltage	250 V AC/DC
Minimum switching voltage	12 V (at 100 mA)
Limiting continuous current	6 A
Maximum switch-on current	165 A (20 ms) / 800 A (peak, at capacitive load, 230 V AC, 24 μ F)
Minimum switching current	100 mA (at 12 V DC)
General data	
Test voltage input/output	4 kV AC (50 Hz, 1 min.)
Ambient temperature (operation)	-40°C ... 60°C
Mechanical service life	3x 10 ⁷ cycles
Standards/regulations	EN 50178, EN 61810-1
Connection data solid/stranded/AWG	0.14 - 2.5 mm ² / 0.14 - 2.5 mm ² / 26 - 14
Dimensions	14 mm / 80 mm / 94 mm W / H / D

Ordering data

Description	Input voltage U_N	Type	Order No.	Pcs./Pkt.
PLC INTERFACE, with screw connection				
①	24 V DC	PLC-RSC- 24DC/ 1ICT/ACT	1078680	10
PLC-INTERFACE, with Push-in connection				
①	24 V DC	PLC-RPT- 24DC/ 1ICT/ACT	1078683	10

PLC-INTERFACE – Highly-compact relay modules

PLC-INTERFACE for high continuous currents

PLC relay modules for high continuous switching currents

The advantages:

- Maximum continuous current 10 A
- Safe isolation in accordance with DIN EN 50178 between coil and contact
- Screw and Push-in connection technology
- Functional plug-in bridges
- Efficient connection to system cabling using V8 adapter
- Long electrical service life, thanks to 16 A relay
- All common input voltages of 12 V DC to 230 V AC

Notes:
Type of insulating housing: Polyamide PBT non-reinforced, color: gray.
Marking systems and mounting material See Catalog 3
Separating plate PLC-ATP must be installed for voltages larger than 250 V (L1, L2, L3) between identical terminal blocks in adjacent modules. Potential bridging is then carried out with FBST 8-PLC... or FBST 500....
For diagrams of operating voltage ranges, see page 399
See the website for more information on connection cross sections with ferrules.
1) 230 V types up to 55°C



1-changeover-contact relay module,
max. 10 A

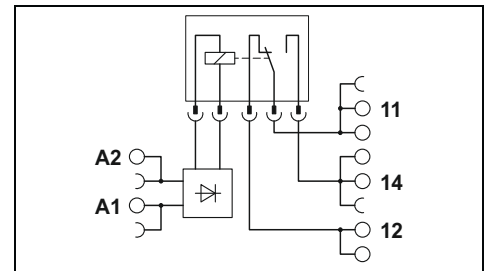

	①	②	③	④	⑤	⑥	⑦
Input data	33	18	17.5	20	10	4.2	4.5
Typical input current at U_N [mA]	8/10	8/10	8/10	8/10	8/10	7/10	7/10
Response/release time at U_N [ms]	Yellow LED, reverse polarity protection, free-wheeling diode						
Input circuit DC	Yellow LED, bridge rectifier						
Input circuit AC/DC							
Output data							
Contact material	AgNi						
Max. switching voltage	250 V AC/DC						
Minimum switching voltage	12 V AC/DC						
Limiting continuous current	10 A						
Maximum switch-on current	30 A (300 ms)						
Minimum switching current	10 mA (at 12 V)						
General data							
Test voltage input/output	4 kV AC (50 Hz, 1 min.)						
Ambient temperature (operation)	-40°C ... 60°C ¹⁾						
Mechanical service life	3x 10 ⁷ cycles						
Standards/regulations	IEC 60664, EN 50178						
Connection data solid/stranded/AWG	0.14 - 2.5 mm ² / 0.14 - 2.5 mm ² / 26 - 14						
Dimensions	14 mm / 80 mm / 94 mm						
EMC note	Class A product, see page 583						

Ordering data

Description	Input voltage U_N	Type	Order No.	Pcs./Pkt.
PLC INTERFACE, with screw connection				
①	12 V DC	PLC-RSC- 12DC/21HC	2967617	10
②	24 V DC	PLC-RSC- 24DC/21HC	2967620	10
③	24 V AC/DC	PLC-RSC- 24UC/21HC	2967633	10
④	48 V DC	PLC-RSC- 48DC/21HC	2967646	10
⑤	60 V DC	PLC-RSC- 60DC/21HC	2967659	10
⑥	120 V AC / 110 V DC	PLC-RSC-120UC/21HC	2967662	10
⑦	230 V AC / 220 V DC	PLC-RSC-230UC/21HC	2967675	10
PLC-INTERFACE, with Push-in connection				
①	12 V DC	PLC-RPT- 12DC/21HC	2900290	10
②	24 V DC	PLC-RPT- 24DC/21HC	2900291	10
③	24 V AC/DC	PLC-RPT- 24UC/21HC	2900293	10
④	48 V DC	PLC-RPT- 48DC/21HC	2900294	10
⑤	60 V DC	PLC-RPT- 60DC/21HC	2900295	10
⑥	120 V AC / 110 V DC	PLC-RPT-120UC/21HC	2900296	10
⑦	230 V AC / 220 V DC	PLC-RPT-230UC/21HC	2900297	10

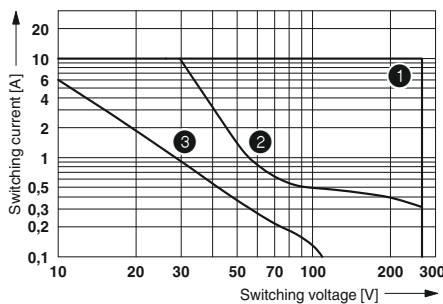

- ① AC, ohmic load
- ② DC, ohmic load
- ③ DC, L/R = 40 ms

Max. interrupting rating

PLC-INTERFACE
with hybrid solid-state relay

The solid-state relay, combined with a mechanical relay, offers the following advantages:

- Higher electrical service life
- Lower power dissipation
- Option of bridging adjacent modules
- Status display
- Protection circuits in input and output
- Switching capacity up to 230 V AC/10 A
- Screw and Push-in connection technology

Notes:
See the website for more information on connection cross sections with ferrules.



Hybrid solid-state relay,
AC output max. 10 A and
bypass relay

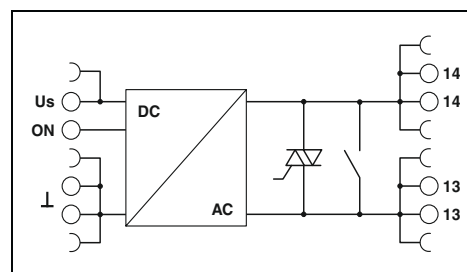

Technical data

Input data	①
Rated control supply voltage U_s	24 [V DC]
Rated control supply voltage range with reference to U_s	0.8 - 1.2
Rated control supply current I_s	14 mA (input low, output low) 19 mA (input high, output high)
Rated actuation voltage U_c ON	24 [V DC]
Rated actuating voltage range with reference to U_c	0.8 - 1.2
Rated actuating current I_c	6.8 [mA]
Input circuit DC	Yellow LED, reverse polarity protection, surge protection
Output data	
Max. switching voltage	253 V AC
Minimum switching voltage	24 V AC
Minimum/maximum switching current	100 mA / 10 A (see derating curve)
Output protection	RCV circuit
Leakage current in off state	<1 mA
Max. load value	350 A ² s (tp = 10 ms, at 25°C)
General data	
Rated insulation voltage	260 V AC
Rated surge voltage	6 kV
Insulation	safe isolation
Ambient temperature (operation)	-25°C ... 60°C
Standards/regulations	DIN EN 50178
Degree of pollution/surge voltage category	2 / III
Connection data solid/stranded/AWG	0.14 - 2.5 mm ² / 0.14 - 2.5 mm ² / 26 - 14
Dimensions	14 mm / 80 mm / 94 mm
EMC note	Class A product, see page 583

Ordering data

Description	Rated actuating voltage U_c	Type	Order No.	Pcs./Pkt.
PLC INTERFACE, with screw connection				
①	24 V DC	PLC-HSC-24DC/230AC/10	2905214	1
PLC-INTERFACE, with Push-in connection				
①	24 V DC	PLC-HPT-24DC/230AC/10	2905215	1

Relay modules

PLC-INTERFACE – Highly-compact relay modules

PLC-INTERFACE for hazardous areas

Relay modules with ATEX, IECEx, and Class 1, Division 2 approval for potentially explosive applications as well as solid-state relays with Class 1, Division 2 approval.

The advantages:

- Slim design
- Functional plug-in bridges
- Integrated input and interference suppression circuit
- RTIII-sealed relays
- Safe isolation in accordance with DIN EN 50178 between coil and contact



1-changeover-contact relay module, 6 A, maximum



2-changeover-contact relay module, 2 x 6 A, maximum

Notes:	
Type of insulating housing:	Polyamide PBT non-reinforced, color: gray.
Marking systems and mounting material	See Catalog 3
Separating plate PLC-ATP must be installed for voltages larger than 250 V (L1, L2, L3) between identical terminal blocks in adjacent modules. Potential bridging is then carried out with FBST 8-PLC... or FBST 500....	
See the website for more information on connection cross sections with ferrules.	
1) Ambient temperature (operation):	-40°C ... 55°C (ATEX / IECEx)

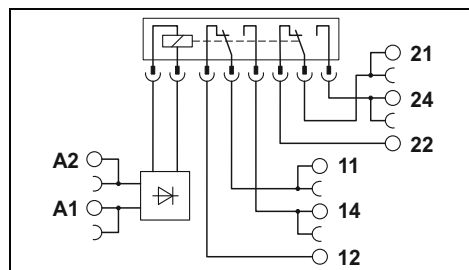
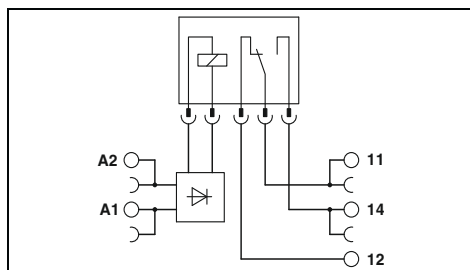

Input data	
Permissible range (with reference to U _N)	
Switching level (with reference to U _N)	1 signal ("H") 0 signal ("L")
Typical input current at U _N	[mA]
Typical response time/switch-on time at U _N	[ms]
Typical release time/switch-off time at U _N	[ms]
Transmission frequency f _{limit}	[Hz]
Input circuit DC	
Input circuit AC/DC	
Output data	
Contact material	AgSnO
Max. switching voltage	250 V AC/DC
Minimum switching voltage	5 V (at 100 mA)
Limiting continuous current	6 A
Maximum switch-on current	10 A (4 s)
Minimum switching current	10 mA (at 12 V)
Output protection	-
Voltage drop at maximum limiting continuous current	-
General data	
Test voltage input/output	4 kV AC (50 Hz, 1 min.)
Ambient temperature (operation)	-20°C ... 60°C (UL), -40°C ... 60°C (ATEX / IECEx)
Mechanical service life	2x 10 ⁷ cycles
Standards/regulations	IEC 60664, EN 50178, EN 60079-0, -7, -15
Degree of pollution/surge voltage category	3 / III
Connection data solid/stranded/AWG	0.14 - 2.5 mm ² / 0.14 - 2.5 mm ² / 26 - 14
Dimensions	W / H / D 6.2 mm / 80 mm / 94 mm
EMC note	Class A product, see page 583
Conformance/approvals	
Conformance	CE-compliant
ATEX	Ex II 3G Ex ec nC IIC T4 Gc (IBExU16ATEXB015 X)
IECEx	Ex ec nC IIC T4 Gc (IECEx IBE 16.0029X)
UL, USA	Class I, Zone 2, AEx nA nC IIC T6
UL, USA/Canada	Class I, Div. 2, Groups A, B, C, D
UL, Canada	Class I, Zone 2, Ex nA nC IIC Gc T6 X

Technical data				
①	②	③	④	
See diagram				
				Yellow LED, reverse polarity protection, free-wheeling diode
				Yellow LED, bridge rectifier
				AgSnO
				250 V AC/DC
				5 V (at 100 mA)
				6 A
				10 A (4 s)
				10 mA (at 12 V)
				-
				-
				4 kV AC (50 Hz, 1 min.)
				-20°C ... 60°C (UL), -40°C ... 60°C (ATEX / IECEx)
				2x 10 ⁷ cycles
				IEC 60664, EN 50178, EN 60079-0, -7, -15
				3 / III
				0.14 - 2.5 mm ² / 0.14 - 2.5 mm ² / 26 - 14
				6.2 mm / 80 mm / 94 mm
				Class A product, see page 583
				CE-compliant
				Ex II 3G Ex ec nC IIC T4 Gc (IBExU16ATEXB015 X)
				Ex ec nC IIC T4 Gc (IECEx IBE 16.0029X)
				Class I, Zone 2, AEx nA nC IIC T6
				Class I, Div. 2, Groups A, B, C, D
				Class I, Zone 2, Ex nA nC IIC Gc T6 X

Technical data				
①	②	③	④	
See diagram				
				Yellow LED, reverse polarity protection, free-wheeling diode
				Yellow LED, bridge rectifier
				AgNi
				250 V AC/DC
				5 V AC/DC (at 10 mA)
				6 A
				15 A (300 ms)
				10 mA (at 5 V)
				-
				-
				4 kV AC (50 Hz, 1 min.)
				-20°C ... 60°C (UL), -40°C ... 60°C (ATEX / IECEx)
				3x 10 ⁷ cycles
				IEC 60664, EN 50178, EN 60079-0, -7, -15
				2 / III
				0.14 - 2.5 mm ² / 0.14 - 2.5 mm ² / 26 - 14
				14 mm / 80 mm / 94 mm
				Class A product, see page 583
				CE-compliant
				Ex II 3G Ex ec nC IIC T4 Gc (IBExU16ATEXB015 X)
				Ex ec nC IIC T4 Gc (IECEx IBE 16.0029X)
				Class I, Zone 2, AEx nA nC IIC T6
				Class I, Div. 2, Groups A, B, C, D
				Class I, Zone 2, Ex nA nC IIC Gc T6 X

Description	Input voltage U _N
PLC INTERFACE, with screw connection	
①	12 V DC
②	24 V DC
③	120 V AC / 110 V DC
④	230 V AC / 220 V DC
PLC-INTERFACE, with Push-in connection	
①	12 V DC
③	24 V DC
④	120 V AC / 110 V DC
⑤	230 V AC / 220 V DC

Ordering data			
Type	Order No.	Pcs./Pkt.	
PLC-RSC-12DC/21/EX	2909522	10	
PLC-RSC-24DC/21/EX	2909524	10	
PLC-RSC-120UC/21/EX	2909525	10	
PLC-RSC-230UC/21/EX ¹⁾	2909526	10	
PLC-RPT-12DC/21/EX	2909527	10	
PLC-RPT-24DC/21/EX	2909528	10	
PLC-RPT-120UC/21/EX	2909529	10	
PLC-RPT-230UC/21/EX ¹⁾	2909530	10	

Ordering data			
Type	Order No.	Pcs./Pkt.	
PLC-RSC-12DC/21-21/EX	2909517	10	
PLC-RSC-24DC/21-21/EX	2909509	10	
PLC-RSC-120UC/21-21/EX	2909511	10	
PLC-RSC-230UC/21-21/EX ¹⁾	2909512	10	
PLC-RPT-12DC/21-21/EX	2909513	10	
PLC-RPT-24DC/21-21/EX	2909514	10	
PLC-RPT-120UC/21-21/EX	2909515	10	
PLC-RPT-230UC/21-21/EX ¹⁾	2909516	10	



1-changeover-contact relay module,
max. 10 A



Solid-state relay module,
DC output max. 3 A



Solid-state relay module,
DC output max. 100 mA

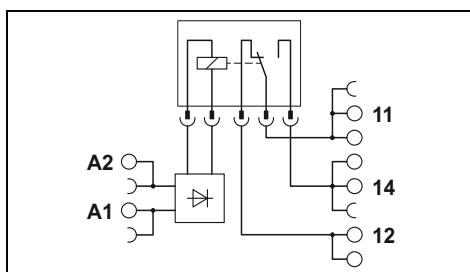

Technical data

① ② ③ ④
See diagram

33	18	4.5	4.5
8	8	7	7
10	10	10	10

Yellow LED, reverse polarity protection, free-wheeling diode
Yellow LED, bridge rectifier

AgNi
250 V AC/DC
12 V AC/DC
10 A
30 A (300 ms)
10 mA (at 12 V)
-
-

4 kV AC (50 Hz, 1 min.)
-20°C ... 60°C (UL), -40°C ... 60°C (ATEX / IECEx)
3x 10⁷ cycles
IEC 60664, EN 50178, EN 60079-0, -7, -15
2 / III
0.14 - 2.5 mm² / 0.14 - 2.5 mm² / 26 - 14
14 mm / 80 mm / 94 mm
Class A product, see page 583

CE-compliant
Ex II 3G Ex ec nC IIC T4 Gc (I BExU16ATEXB015 X)
Ex ec nC IIC T4 Gc (IECEx IBE 16.0029X)
Class I, Zone 2, AEx nA nC IIC T6
Class I, Div. 2, Groups A, B, C, D
Class I, Zone 2, Ex nA nC IIC Gc T6 X

Ordering data

Type	Order No.	Pcs./Pkt.
PLC-RSC-12DC/21HC/EX	2909518	10
PLC-RSC-24DC/21HC/EX	2909519	10
PLC-RSC-120UC/21HC/EX	2909520	10
PLC-RSC-230UC/21HC/EX ¹⁾	2909521	10
PLC-RPT-12DC/21HC/EX	2909531	10
PLC-RPT-24DC/21HC/EX	2909532	10
PLC-RPT-120UC/21HC/EX	2909533	10
PLC-RPT-230UC/21HC/EX ¹⁾	2909534	10

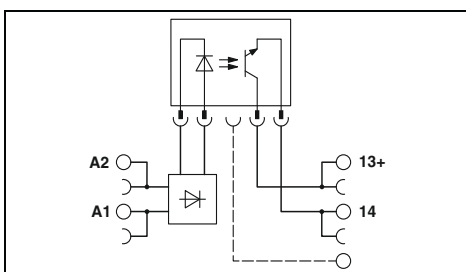

Technical data

②	③
0.8 - 1.2	0.9 - 1.1
≥0.8	≥0.8
≤0.4	≤0.3
8.5	3.5
0.02	3.5
0.3	7
300	10

Yellow LED, reverse polarity protection, free-wheeling diode
Yellow LED, bridge rectifier

-
33 V DC
3 V DC
3 A
15 A (10 ms)
-
Reverse polarity protection, surge protection
≤200 mV

2.5 kV (50 Hz, 1 min.)
-20°C ... 60°C
-
IEC 60664, EN 50178
2 / III
0.14 - 2.5 mm² / 0.14 - 2.5 mm² / 26 - 14
6.2 mm / 80 mm / 94 mm
Class A product, see page 583

CE-compliant
-
-
Class I, Zone 2, AEx nA nC IIC T6
Class I, Div. 2, Groups A, B, C, D
Class I, Zone 2, Ex nA nC IIC Gc T6 X

Ordering data

Type	Order No.	Pcs./Pkt.
PLC-OSC- 24DC/ 24DC/ 2/C1D2	5603260	10
PLC-OSC-120UC/ 24DC/ 2/C1D2	5603262	10

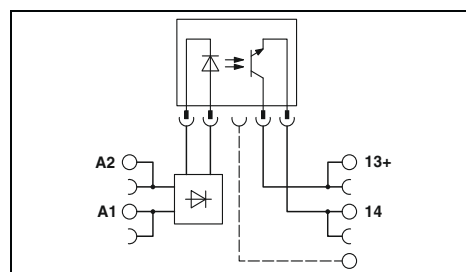

Technical data

②	③
0.8 - 1.2	0.9 - 1.1
≥0.8	≥0.9
≤0.4	≤0.3
8.5	3.5
0.02	3
0.3	4
300	10

Yellow LED, reverse polarity protection, free-wheeling diode
Yellow LED, bridge rectifier

-
48 V DC
3 V DC
100 mA
-
-
Reverse polarity protection, surge protection
≤1 V

2.5 kV (50 Hz, 1 min.)
-20°C ... 60°C
-
IEC 60664, EN 50178
2 / III
0.14 - 2.5 mm² / 0.14 - 2.5 mm² / 26 - 14
6.2 mm / 80 mm / 94 mm
Class A product, see page 583

CE-compliant
-
-
Class I, Zone 2, AEx nA nC IIC T6
Class I, Div. 2, Groups A, B, C, D
Class I, Zone 2, Ex nA nC IIC Gc T6 X

Ordering data

Type	Order No.	Pcs./Pkt.
PLC-OSC- 24DC/ 48DC/100/C1D2	5603261	10
PLC-OSC-120UC/ 48DC/100/C1D2	5603263	10

PLC-INTERFACE – Highly-compact relay modules

Basic terminal blocks with interference current filter that can be fitted with relays

PLC basic terminal blocks with integrated filter to protect against interference voltages or currents due, for example, to long control lines.

The advantages:

- Resistant to interference currents
- High relay release voltage
- Typical applications:
 - Applications with long control lines
 - Use of AC output boards, resulting in residual AC currents
- Screw and Push-in connection technology

Notes:
Type of insulating housing: Polyamide PBT non-reinforced, color: gray.
Marking systems and mounting material See Catalog 3
Separating plate PLC-ATP must be installed for voltages larger than 250 V (L1, L2, L3) between identical terminal blocks in adjacent modules. Potential bridging is then carried out with FBST 8-PLC... or FBST 500....
For diagrams of operating voltage ranges, see page 399
Maximum interrupting rating diagrams, see page 402
When mounting relays on a DIN rail base or PCB, data may be limited, especially with regard to the limiting continuous current and/or ambient temperature range. See "General" section in "Fundamentals of relay technology" on page 272
See the website for more information on connection cross sections with ferrules.
If the specified maximum values for multi-layer contact relays are exceeded, the gold plating is destroyed. The maximum values of the power contact relay are then valid. This can result in a shorter service life than with a pure power contact.



Basic terminal block with Input filter

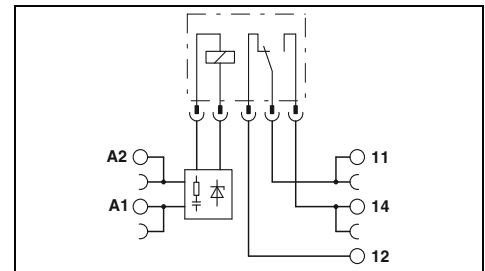

Technical data

Input data	Output data with:	General data	Connection data solid/stranded/AWG	Dimensions	EMC note
Nominal input voltage U_N	Contact type	Test voltage input/output	0.14 - 2.5 mm ² / 0.14 - 2.5 mm ² / 26 - 14	W / H / D	
Permissible range (with reference to U_N)	Contact material	Ambient temperature (operation)	6.2 mm / 80 mm / 94 mm		
Typical release voltage (relay assembly)	Max. switching voltage	Mechanical service life	Class A product, see page 583		
Typical input current at U_N (50/60 Hz)	Minimum switching voltage	Standards/regulations			
Typical response time at U_N	Limiting continuous current	Degree of pollution/overvoltage category			
Typical release time at U_N	Maximum switch-on current				
Input circuit	Minimum switching current				
REL-MR-60DC/21	General data				
Single contact, 1-PDT	REL-MR-60DC/21AU				
AgSnO	Single contact, 1-PDT				
250 V AC/DC	AgSnO, hard gold-plated				
5 V (at 100 mA)	30 V AC / 36 V DC				
6 A	100 mV (at 10 mA)				
on request	50 mA				
10 mA (at 12 V)	50 mA				
	1 mA (at 24 V)				

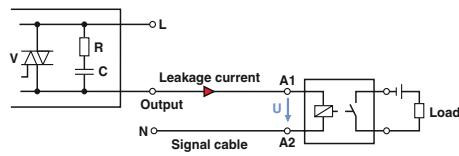

Occurrence of interference signals
Scenario 1: controller - AC output card

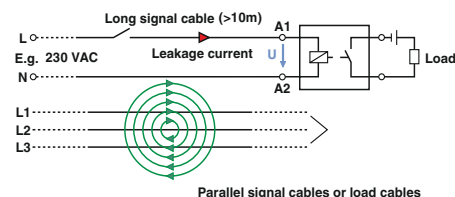

Occurrence of interference signals
Scenario 2: long signal cables

Description	Voltage U_N
PLC-INTERFACE basic terminal block , for pluggable miniature relays or solid-state relays	
with screw connection	120 V AC
with screw connection	230 V AC
with Push-in connection	120 V AC
with Push-in connection	230 V AC

Plug-in miniature power relays, with multi-layer gold contacts

REL-MR- 60DC/21AU	2961134	10
REL-MR- 60DC/21	2961118	10

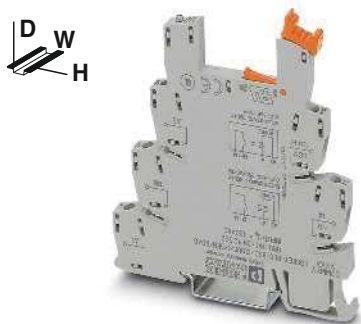

Basic terminal block with additional floating terminal point and input filter

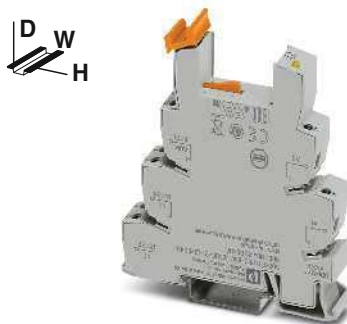

2-changeover-contact basic terminal block with input filter

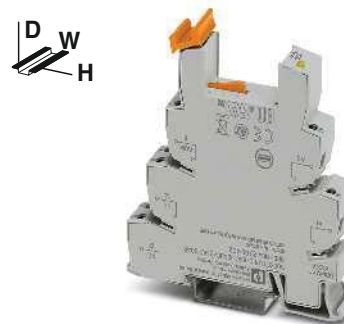

1-changeover-contact basic terminal block for high continuous currents with input filter

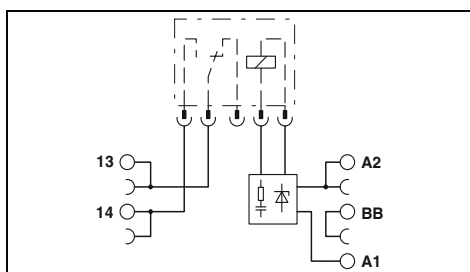

Technical data

120 V AC	230 V AC
0.8 ... 1.4	0.78 ... 1.14
50 V AC	80 V AC
7 mA / 8 mA	8.8 mA / 10 mA
7 ms	7 ms
20 ms	20 ms
Yellow LED, bridge rectifier, filter	
REL-MR-60DC/21	REL-MR-60DC/21AU
Single contact, 1 N/O contact	Single contact, 1 N/O contact
AgSnO	AgSnO, hard gold-plated
250 V AC/DC	30 V AC / 36 V DC
5 V (at 100 mA)	100 mV (at 10 mA)
6 A	50 mA
on request	50 mA
10 mA (at 12 V)	1 mA (at 24 V)

4 kV (50 Hz, 1 min.)
 -20°C ... 55°C
 2x 10⁷ cycles
 IEC 60664, EN 50178
 3 / III

0.14 - 2.5 mm² / 0.14 - 2.5 mm² / 26 - 14
 6.2 mm / 80 mm / 94 mm
 Class A product, see page 583

Ordering data

Type	Order No.	Pcs./Pkt.
PLC-BSC-120UC/ 1/SEN/SO46	2980322	10
PLC-BSC-230UC/ 1/SEN/SO46	2980348	10
PLC-BPT-120UC/ 1/SEN/SO46	2900456	10
PLC-BPT-230UC/ 1/SEN/SO46	2900457	10

Accessories

REL-MR- 60DC/21AU	2961134	10
REL-MR- 60DC/21	2961118	10

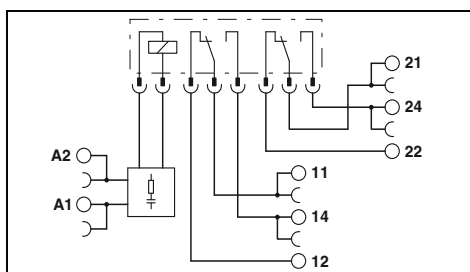

Technical data

120 V AC	230 V AC
0.78 ... 1.4	0.78 ... 1.14
16 V AC	70 V AC
6 mA / 7 mA	8.5 mA / 10 mA
7 ms	7 ms
10 ms	10 ms
Yellow LED, bridge rectifier, filter	
REL-MR-110DC/21-21	REL-MR-110DC/21-21AU
Single contact, 2-PDT	Single contact, 2-PDT
AgNi	AgNi, + 5 µm Au
250 V AC/DC	30 V AC / 36 V DC
5 V AC/DC	100 mV
6 A	50 mA
15 A (300 ms)	50 mA
10 mA	1 mA

4 kV (50 Hz, 1 min.)
 -20°C ... 55°C
 3x 10⁷ cycles
 IEC 60664, EN 50178
 3 / III

0.14 - 2.5 mm² / 0.14 - 2.5 mm² / 26 - 14
 14 mm / 80 mm / 94 mm
 Class A product, see page 583

Ordering data

Type	Order No.	Pcs./Pkt.
PLC-BSC-120UC/21-21/SO46	2980416	10
PLC-BSC-230UC/21-21/SO46	2980429	10

Accessories

REL-MR-110DC/21-21AU	2961228	10
REL-MR-110DC/21-21	2961202	10

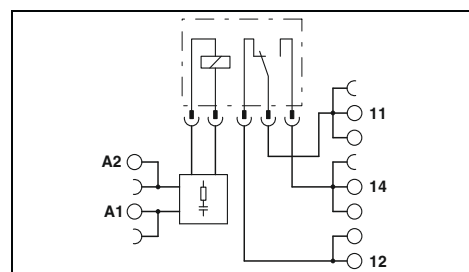

Technical data

120 V AC	230 V AC
0.85 ... 1.4	0.78 ... 1.14
16 V AC	70 V AC
6 mA / 7 mA	8.5 mA / 10 mA
7 ms	7 ms
20 ms	20 ms
Yellow LED, bridge rectifier, filter	
REL-MR-110DC/21HC	
Single contact, 1-PDT	
AgNi	
250 V AC/DC	
12 V AC/DC	
10 A	
30 A (300 ms)	
100 mA	

4 kV (50 Hz, 1 min.)
 -20°C ... 55°C
 3x 10⁷ cycles
 IEC 60664, EN 50178
 3 / III

0.14 - 2.5 mm² / 0.14 - 2.5 mm² / 26 - 14
 14 mm / 80 mm / 94 mm
 Class A product, see page 583

Ordering data

Type	Order No.	Pcs./Pkt.
PLC-BSC-120UC/21HC/SO46	2980432	10
PLC-BSC-230UC/21HC/SO46	2980445	10

Accessories

REL-MR-110DC/21HC	2961338	10
-------------------	---------	----

PLC-INTERFACE – Highly-compact relay modules

Basic terminal blocks with interference current filter that can be fitted with solid-state relays

PLC basic terminal blocks with integrated filter to protect against interference voltages or currents due, for example, to long control lines.

The advantages:

- Resistant to interference currents
 - High relay release voltage
- Typical applications:
- Applications with long control lines
 - Use of AC output boards, resulting in residual AC currents

Notes:
Type of insulating housing: Polyamide PBT non-reinforced, color: gray.
Marking systems and mounting material See Catalog 3
Separating plate PLC-ATP must be installed for voltages larger than 250 V (L1, L2, L3) between identical terminal blocks in adjacent modules. Potential bridging is then carried out with FBST 8-PLC... or FBST 500....
For diagrams of operating voltage ranges, see page 399
Maximum interrupting rating diagrams, see page 402
When mounting relays on a DIN rail base or PCB, data may be limited, especially with regard to the limiting continuous current and/or ambient temperature range. See "General" section in "Fundamentals of relay technology" on page 272
See the website for more information on connection cross sections with ferrules.
If the specified maximum values for multi-layer contact relays are exceeded, the gold plating is destroyed. The maximum values of the power contact relay are then valid. This can result in a shorter service life than with a pure power contact.



Basic terminal block with input filter

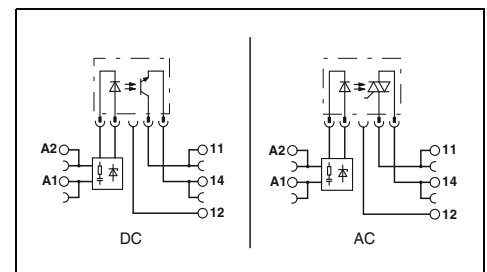

Input data	
Nominal input voltage U_N	
Permissible range (with reference to U_N)	
Switching level (with optocoupler) 0 signal ("L")	
Typical input current at U_N (50/60 Hz)	
Typical response time/switch-on time at U_N	
Typical switch-off time at U_N	
Input circuit	
Output data with:	
Max. switching voltage	
Minimum switching voltage	
Limiting continuous current	
Maximum switch-on current	
Output protection	
Voltage drop at limiting continuous current	
Leakage current in off state	
Maximum phase shift (inductive consumer)	
Max. load value $I^2 \times t$ ($t = 10$ ms)	
General data	
Test voltage input/output	
Ambient temperature (operation)	
Standards/regulations	
Degree of pollution/overvoltage category	
Connection data solid/stranded/AWG	
Dimensions	W / H / D
EMC note	

Technical data		
120 V AC	230 V AC	
0.85 ... 1.1	0.8 ... 1.1	
≤ 0.4	≤ 0.4	
7 mA / 8 mA	8.8 mA / 10 mA	
6 ms	6 ms	
10 ms	10 ms	
Yellow LED, bridge rectifier, filter		
OPT...48DC/...	OPT...24DC/...	OPT...230AC/...
48 V DC	30 V DC	253 V AC
3 V DC	3 V DC	24 V AC
100 mA	3 A	0.75 A
	15 A (10 ms)	30 A (10 ms)
Reverse polarity protection, surge protection		RCV circuit
<1 V	<200 mV	<1 V
-	-	<1 mA
-	-	0.5
-	-	4.5 A 2 s
2.5 kV (50 Hz, 1 min.)		
-20°C ... 55°C		
IEC 60664, EN 50178		
2 / III		
0.14 - 2.5 mm 2 / 0.14 - 2.5 mm 2 / 26 - 14		
6.2 mm / 80 mm / 94 mm		
Class A product, see page 583		

Description	Voltage U_N
PLC-INTERFACE basic terminal block , for pluggable miniature relays or solid-state relays	
with screw connection	120 V AC
with screw connection	230 V AC
with Push-in connection	120 V AC
with Push-in connection	230 V AC

Ordering data		
Type	Order No.	Pcs./Pkt.
PLC-BSC-120UC/21/SO46	2980319	10
PLC-BSC-230UC/21/SO46	2980335	10
PLC-BPT-120UC/21/SO46	2900453	10
PLC-BPT-230UC/21/SO46	2900455	10

Pluggable solid-state relays	
Solid-state input relays	
Solid-state power relays	
Solid-state power relays	

Accessories		
OPT-60DC/ 48DC/100	2966621	10
OPT-60DC/ 24DC/ 2	2966605	10
OPT-60DC/230AC/ 1	2967963	10

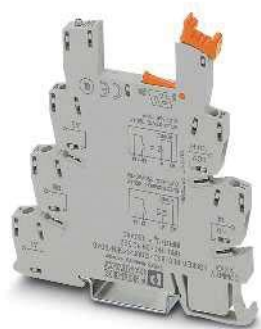

**Basic terminal block
with additional floating terminal point
and input filter**

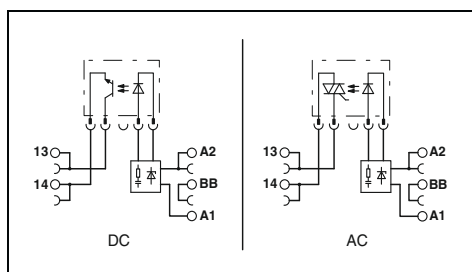

Technical data

120 V AC	230 V AC
0.85 ... 1.1	0.8 ... 1.1
≤0.4	≤0.4
7 mA / 8 mA	8.8 mA / 10 mA
6 ms	6 ms
10 ms	10 ms
Yellow LED, bridge rectifier, filter	
OPT...48DC/...	OPT...24DC/...
48 V DC	30 V DC
3 V DC	3 V DC
100 mA	3 A
	15 A (10 ms)
Reverse polarity protection, surge protection	RCV circuit
<1 V	<200 mV
-	<1 mA
-	0.5
-	4.5 A²s

2.5 kV (50 Hz, 1 min.)
 -20°C ... 55°C
 IEC 60664, EN 50178
 2 / III
 0.14 - 2.5 mm² / 0.14 - 2.5 mm² / 26 - 14
 6.2 mm / 80 mm / 94 mm
 Class A product, see page 583

Ordering data

Type	Order No.	Pcs./Pkt.
PLC-BSC-120UC/ 1/SEN/SO46	2980322	10
PLC-BSC-230UC/ 1/SEN/SO46	2980348	10
PLC-BPT-120UC/ 1/SEN/SO46	2900456	10
PLC-BPT-230UC/ 1/SEN/SO46	2900457	10

Accessories

OPT-60DC/ 48DC/100	2966621	10
OPT-60DC/ 24DC/ 2	2966605	10
OPT-60DC/230AC/ 1	2967963	10

Relay modules

PLC-INTERFACE – Highly-compact relay modules

Relay modules with filter and predefined switch-on and switch-off thresholds to protect against high interference signals

PLC relay module with integrated wiring to protect against interference voltages or currents due, for example, to long control lines.

The advantages:

- Resistant to high interference signals, thanks to hysteresis
- High relay release voltage up to 180 V AC

Typical applications:

- Applications with long control lines
- Use of AC output boards, resulting in residual AC currents
- Screw and Push-in connection technology

new



2-changeover contact with predefined switch-on and switch-off threshold

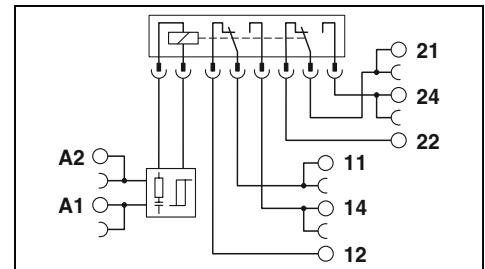

Technical data

	①	②
Input data		
Typical input current at U_N	4.5	4.5
Response/release time at U_N	7 / 10	7 / 10
Switch-on threshold	190 V	190 V
	AC	AC
Switch-off threshold	180 V	180 V
	AC	AC
Input circuit AC/DC	Yellow LED, bridge rectifier	
Output data		
Contact material	AgNi	
Max. switching voltage	250 V AC/DC	
Minimum switching voltage	5 V AC/DC (at 10 mA)	
Limiting continuous current	6 A	
Maximum switch-on current	15 A (300 ms)	
Minimum switching current	10 mA (at 5 V)	
General data		
Test voltage input/output	4 kV AC (50 Hz, 1 min.)	
Ambient temperature (operation)	-40°C ... 55°C	
Mechanical service life	3x 10 ⁷ cycles	
Standards/regulations	IEC 60664, EN 50178	
Connection data solid/stranded/AWG	0.14 - 2.5 mm ² / 0.14 - 2.5 mm ² / 26 - 14	
Dimensions	W / H / D 14 mm / 80 mm / 94 mm	

Ordering data

Description	Input voltage U_N	Type	Order No.	Pcs./Pkt.
PLC-INTERFACE				
- with screw connection	① 230 V AC	PLC-RSC-230AC/21-21/SO46/HI	1079387	10
- with Push-in connection	② 230 V AC	PLC-RPT-230AC/21-21/SO46/HI	1079389	10

new



**1-changeover contact
for high continuous currents with
predefined switch-on and switch-off threshold**

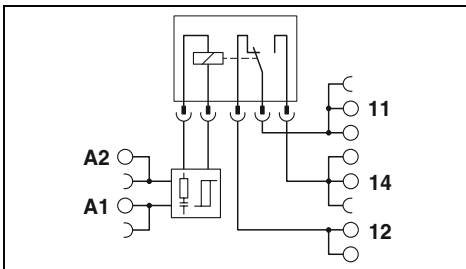

Technical data

①	②
4.5	4.5
7 / 10	7 / 10
190 V	190 V
AC	AC
180 V	180 V
AC	AC

Yellow LED, bridge rectifier

AgNi
250 V AC/DC
12 V (at 10 mA)
10 A
30 A (300 ms)
10 mA (at 12 V)

4 kV AC (50 Hz, 1 min.)
-40°C ... 55°C
3x 10⁷ cycles
IEC 60664, EN 50178
0.14 - 2.5 mm² / 0.14 - 2.5 mm² / 26 - 14
14 mm / 80 mm / 94 mm

Ordering data

Type	Order No.	Pcs./Pkt.
PLC-RSC-230AC/21HC/SO46/HI	1079402	10
PLC-RPT-230AC/21HC/SO46/HI	1079404	10

Plug-in miniature power relays

Plug-in miniature power relays are compatible for PLC-INTERFACE and RIF-0 and RIF-1 relay base.

The advantages:

- Power contacts up to 16 A
- Multi-layer gold contact or power contact
- High degree of protection up to RT III depending on type (wash-proof)
- Safe isolation in accordance with DIN EN 50178 between coil and contact



Relay with one changeover contact, max. 6 A



Relay with one changeover contact, with manual operation, max. 6 A

Notes:
If the specified maximum values for multi-layer contact relays are exceeded, the gold plating is destroyed. The maximum values of the power contact relay are then valid. This can result in a shorter service life than with a pure power contact.
For dimensional drawings and perforations for assembly, see page 400
For diagrams of operating voltage ranges, see page 399
When mounting relays on a DIN rail base or PCB, data may be limited, especially with regard to the limiting continuous current and/or ambient temperature range. See "General" section in "Fundamentals of relay technology" on page 272

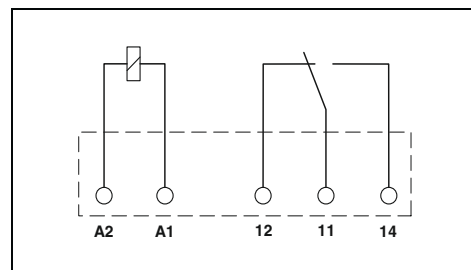
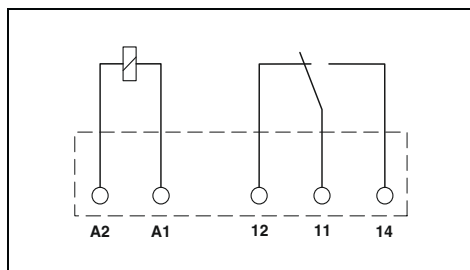

Input data	
Permissible range (with reference to U_N)	
Typical input current at U_N	[mA]
Typical response time at U_N	[ms]
Typical release time at U_N	[ms]
Output data	
Contact type	
Contact material	
Max. switching voltage	
Minimum switching voltage	
Limiting continuous current	
Maximum switch-on current	
Minimum switching current	
Maximum interrupting rating, ohmic load	
	24 V DC
	48 V DC
	60 V DC
	110 V DC
	220 V DC
	250 V AC
General data	
Test voltage (winding/contact)	
Ambient temperature (operation)	
Nominal operating mode	
Mechanical service life	
Standards/regulations	
Mounting position/mounting	
Dimensions	W / H / D

Technical data				
①	②	③	④	⑤
See diagram				
38	14	9	7	3
5	5	5	5	5
2.5	2.5	2.5	2.5	2.5
1 PDT		1 PDT		
AgSnO		AgSnO, hard gold-plated		
250 V AC/DC		30 V AC / 36 V DC		
5 V (at 100 mA)		100 mV (at 10 mA)		
6 A		50 mA		
10 A (4 s)		on request		
10 mA (at 12 V)		1 mA (at 24 V)		
140 W		1.2 W		
20 W		-		
18 W		-		
23 W		-		
40 W		-		
1,500 VA		-		
4 kV AC (50 Hz, 1 min.)				
-40°C ... 85°C				
100% operating factor				
2x 10 ⁷ cycles				
IEC 60664, EN 50178, EN 61810-1				
Any / in rows with zero spacing				
5 mm / 28 mm / 15 mm				

Technical data		
②	④	⑤
See diagram		
14	7	3
5	5	5
2.5	2.5	2.5
1 PDT		1 PDT
AgSnO		AgSnO, hard gold-plated
250 V AC/DC		30 V AC / 36 V DC
5 V (at 100 mA)		100 mV (at 10 mA)
6 A		50 mA
10 A (4 s)		50 mA
10 mA (at 12 V)		1 mA (at 24 V)
140 W		1.2 W
20 W		-
18 W		-
23 W		-
40 W		-
1,500 VA		-
4 kV AC (50 Hz, 1 min.)		
-40°C ... 85°C		
100% operating factor		
1x 10 ⁷ cycles		
IEC 60664, EN 50178, EN 61810-1		
Any / in rows with zero spacing		
5 mm / 28 mm / 16 mm		

Description		Input voltage U_N
Plug-in miniature power relays, with power contacts		
①		4.5 V DC
②		12 V DC
③		18 V DC
④		24 V DC
⑤		60 V DC
⑥		110 V DC
Plug-in miniature power relays, with multi-layer gold contacts		
①		4.5 V DC
②		12 V DC
③		18 V DC
④		24 V DC
⑤		60 V DC
⑥		110 V DC

Ordering data		
Type	Order No.	Pcs./Pkt.
REL-MR- 4,5DC/21	2961367	10
REL-MR- 12DC/21	2961150	10
REL-MR- 18DC/21	2961383	10
REL-MR- 24DC/21	2961105	10
REL-MR- 60DC/21	2961118	10
REL-MR 4,5DC/21AU	2961370	10
REL-MR- 12DC/21AU	2961163	10
REL-MR- 18DC/21AU	2961493	10
REL-MR- 24DC/21AU	2961121	10
REL-MR- 60DC/21AU	2961134	10

Ordering data		
Type	Order No.	Pcs./Pkt.
REL-MR- 12DC/21/MS	2909641	10
REL-MR- 24DC/21/MS	2909642	10
REL-MR- 60DC/21/MS	2909643	10
REL-MR- 12DC/21AU/MS	2909644	10
REL-MR- 24DC/21AU/MS	2909645	10
REL-MR- 60DC/21AU/MS	2909647	10



Relay with two changeover contacts,
2 x 8 A, maximum



Relay with one N/O contact
for high inrush currents,
130 A peak, maximum



Relay with one changeover contact,
16 A, maximum

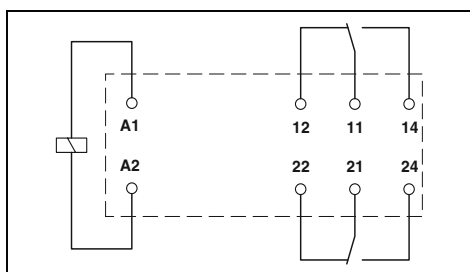

Technical data			
②	④	⑤	⑥
See diagram			
33	17	8.2	4.1
7	7	7	7
3	3	3	3

2 PDT	2 PDT
AgNi	AgNi, hard gold-plated
250 V AC/DC	30 V AC / 36 V DC
5 V (at 10 mA)	100 mV (at 10 mA)
8 A	50 mA
25 A (20 ms)	50 mA
10 mA (at 5 V)	1 mA (at 24 V)

190 W	1.2 W
85 W	-
60 W	-
44 W	-
60 W	-
2,000 VA	-

5 kV AC (50 Hz, 1 min.)
-40°C ... 85°C
100% operating factor
3x 10⁷ cycles
IEC 60664, EN 50178, EN 61810-1
Any / can be aligned without spacing (>70°C ≥2.5 mm)

12.7 mm / 29 mm / 15.7 mm

Ordering data

Type	Order No.	Pcs./Pkt.
REL-MR- 12DC/21-21	2961257	10
REL-MR- 24DC/21-21	2961192	10
REL-MR- 60DC/21-21	2961273	10
REL-MR-110DC/21-21	2961202	10
REL-MR- 12DC/21-21AU	2961299	10
REL-MR- 24DC/21-21AU	2961215	10
REL-MR- 60DC/21-21AU	2961286	10
REL-MR-110DC/21-21AU	2961228	10

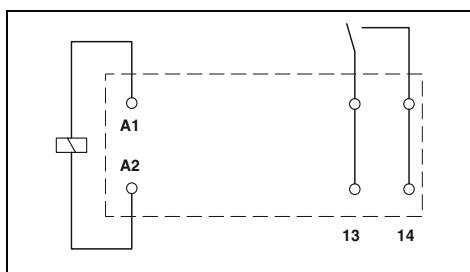

Technical data	
④	
See diagram	
17	
8	
3	

1 N/O contact
AgSnO
250 V AC/DC
12 V (100 mA)
16 A
80 A (20 ms) / 130 A (peak, at capacitive load, 230 V AC, 24 μF)
100 mA (at 12 V DC)

384 W
58 W
48 W
50 W
80 W
4,000 VA

5 kV AC (50 Hz, 1 min.)
-40°C ... 85°C
100% operating factor
3x 10⁷ cycles
EN 50178, EN 61810-1
Any / can be aligned without spacing (>70°C ≥2.5 mm)

12.7 mm / 29 mm / 15.7 mm

Ordering data

Type	Order No.	Pcs./Pkt.
REL-MR- 24DC/11C	2961341	10

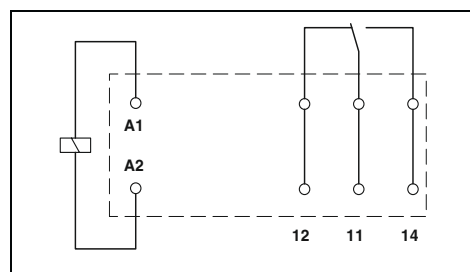

Technical data			
②	④	⑤	⑥
See diagram			
33	17	8.2	4.1
7	7	7	7
3	3	3	3

1 PDT	
AgNi	
250 V AC/DC	
12 V (at 10 mA)	
16 A	
50 A (20 ms)	
10 mA (at 12 V)	

384 W	
58 W	
48 W	
50 W	
80 W	
4,000 VA	

5 kV AC (50 Hz, 1 min.)
-40°C ... 85°C
100% operating factor
3x 10⁷ cycles
IEC 60664, EN 50178, EN 61810-1
Any / can be aligned without spacing (>70°C ≥2.5 mm)

12.7 mm / 29 mm / 15.7 mm

Ordering data

Type	Order No.	Pcs./Pkt.
REL-MR- 12DC/21HC	2961309	10
REL-MR- 24DC/21HC	2961312	10
REL-MR- 60DC/21HC	2961325	10
REL-MR-110DC/21HC	2961338	10

Plug-in solid-state relays

Plug-in solid-state relays are compatible for both PLC-INTERFACE and RIF-0 and RIF-1 relay base.

The advantages:

- Switching current of up to 5 A
- RT III seal (wash-proof)
- Vibration- and shock-resistant
- Wear-free and long-lasting
- Zero voltage switch at AC output
- Can be soldered in on PCB



Solid-state relay,
DC output max. 3 A



Solid-state relay,
DC output max. 100 mA

Notes:

For dimensional drawings and perforations for assembly, see page 401

When mounting relays on a DIN rail base or PCB, data may be limited, especially with regard to the limiting continuous current and/or ambient temperature range. See "General" section in "Fundamentals of relay technology" on page 272

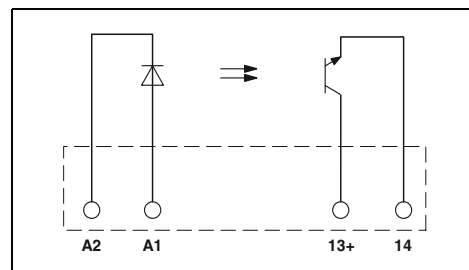
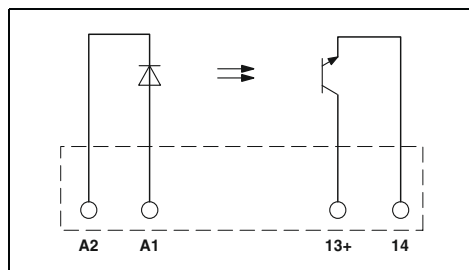

Technical data

Input data	①	②	③
Permissible range (with reference to U_N)	0.8 - 1.2	0.8 - 1.2	0.8 - 1.2
Switching level	2.5	16	35
1 signal ("H") [V DC] \geq	0.8	10	20
0 signal ("L") [V DC] \leq	9	7	3
Typical input current at U_N [mA]	20	20	40
Typical switch-on time at U_N [μ s]	300	300	500
Typical switch-off time at U_N [μ s]	300	300	300
Transmission frequency f_{mit} [Hz]			

Output data	①	②	③
Max. switching voltage	33 V DC		
Minimum switching voltage	3 V DC		
Limiting continuous current	3 A (see derating curve)		
Minimum load current	-		
Maximum switch-on current	15 A (10 ms)		
Leakage current in off state	-		
Phase angle (cos ϕ)	-		
Output circuit	2-conductor, floating		
Max. load value	-		
Output protection	Reverse polarity protection, surge protection		
Voltage drop at maximum limiting continuous current	≤ 150 mV		

General data	①	②	③
Rated surge voltage	Basic insulation		
Test voltage input/output	2.5 kV (50 Hz, 1 min.)		
Ambient temperature (operation)	-25°C ... 60°C		
Nominal operating mode	100% operating factor		
Standards/regulations	IEC 60664, EN 50178		
Degree of pollution/surge voltage category	2 / III		
Mounting position/mounting	Any / in rows with zero spacing		
Dimensions	5 mm / 28 mm / 15 mm		

Ordering data

Description	Input voltage U_N	Type	Order No.	Pcs./Pkt.
Plug-in solid-state relays				
Solid-state power relays	① 5 V DC	OPT-5DC/ 24DC/ 2	2967989	10
Solid-state power relays	② 24 V DC	OPT-24DC/ 24DC/ 2	2966595	10
Solid-state power relays	③ 60 V DC	OPT-60DC/ 24DC/ 2	2966605	10
Plug-in solid-state relays				
Solid-state input relays	① 5 V DC			
Solid-state input relays	② 24 V DC			
Solid-state input relays	③ 60 V DC			

Technical data

Input data	①	②	③
Permissible range (with reference to U_N)	0.8 - 1.2	0.8 - 1.2	0.9 - 1.1
Switching level	2.5	16	52
1 signal ("H") [V DC] \geq	0.8	10	40
0 signal ("L") [V DC] \leq	4	7	3
Typical input current at U_N [mA]	20	20	50
Typical switch-on time at U_N [μ s]	300	300	800
Typical switch-off time at U_N [μ s]	300	300	100
Transmission frequency f_{mit} [Hz]			

Output data	①	②	③
Max. switching voltage	48 V DC		
Minimum switching voltage	3 V DC		
Limiting continuous current	100 mA		
Minimum load current	-		
Maximum switch-on current	-		
Leakage current in off state	-		
Phase angle (cos ϕ)	-		
Output circuit	2-conductor, floating		
Max. load value	-		
Output protection	Reverse polarity protection, surge protection		
Voltage drop at maximum limiting continuous current	≤ 1 V		

General data	①	②	③
Rated surge voltage	Basic insulation		
Test voltage input/output	2.5 kV (50 Hz, 1 min.)		
Ambient temperature (operation)	-25°C ... 60°C		
Nominal operating mode	100% operating factor		
Standards/regulations	IEC 60664, EN 50178		
Degree of pollution/surge voltage category	2 / III		
Mounting position/mounting	Any / in rows with zero spacing		
Dimensions	5 mm / 28 mm / 15 mm		

Ordering data

Description	Input voltage U_N	Type	Order No.	Pcs./Pkt.
Plug-in solid-state relays				
Solid-state power relays	① 5 V DC	OPT-5DC/ 48DC/100	2967992	10
Solid-state power relays	② 24 V DC	OPT-24DC/ 48DC/100	2966618	10
Solid-state power relays	③ 60 V DC	OPT-60DC/ 48DC/100	2966621	10



Solid-state relay,
DC output max. 5 A



Solid-state relay,
AC output max. 750 mA



Solid-state relay,
AC output max. 2 A

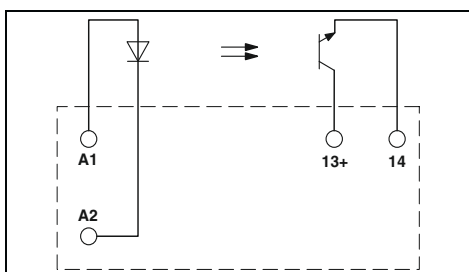

Technical data

①	②	③
0.8 - 1.2	0.8 - 1.2	0.9 - 1.1
2.5	16	35
0.8	10	20
9	7	3
10	20	25
400	400	400
300	300	300

33 V DC
3 V DC
5 A (see derating curve)
-
15 A (10 ms)
-
-
2-conductor, floating
-
Reverse polarity protection, surge protection
≤200 mV

Basic insulation
2.5 kV (50 Hz, 1 min.)
-25°C ... 60°C
100% operating factor
IEC 60664, EN 50178
2 / III

Any / in rows with zero spacing
12.7 mm / 29 mm / 15.7 mm

Ordering data

Type	Order No.	Pcs./Pkt.
OPT-5DC/24DC/ 5	2982113	10
OPT-24DC/24DC/ 5	2982100	10
OPT-60DC/24DC/ 5	2982126	10

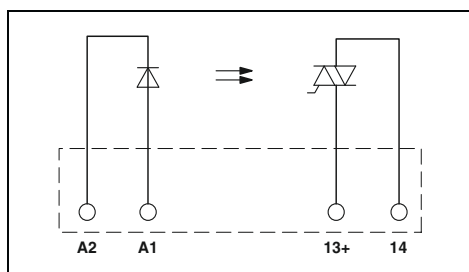

Technical data

②	③
0.8 - 1.2	0.9 - 1.1
10	50
5	15
6	3
6,000	9,000
500	700
10	10

253 V AC
24 V AC
0.75 A (see derating curve)
10 mA
30 A (10 ms)
<1 mA
0.5
2-conductor floating, zero voltage switch
4.5 A²s
RCV circuit
<1 V

Basic insulation
2.5 kV (50 Hz, 1 min.)
-25°C ... 60°C
100% operating factor
IEC 60664, EN 50178
2 / III

Any / in rows with zero spacing
5 mm / 28 mm / 15 mm

Ordering data

Type	Order No.	Pcs./Pkt.
OPT-24DC/230AC/ 1	2967950	10
OPT-60DC/230AC/ 1	2967963	10

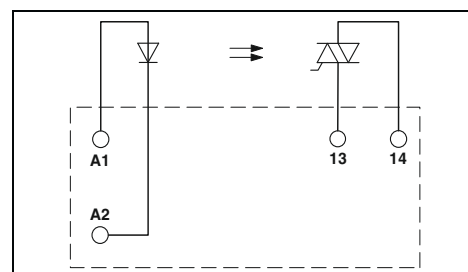

Technical data

①	②
0.8 - 1.2	0.8 - 1.2
3	18
1	8.4
15	7
10,000	10,000
10,000	10,000
10	10

253 V AC
24 V AC
2 A (see derating curve)
25 mA
30 A (10 ms)
<1 mA
-
2-conductor floating, zero voltage switch
4 A²s (tp = 10 ms, at 25°C)
Surge protection
≤1 V

Basic insulation
2.5 kV (50 Hz, 1 min.)
-25°C ... 60°C
100% operating factor
IEC 60664
2 / III

Any / see derating curve
12.7 mm / 29 mm / 15.7 mm

Ordering data

Type	Order No.	Pcs./Pkt.
OPT-5DC/230AC/ 2	2982168	10
OPT-24DC/230AC/ 2	2982171	10

Operating voltage ranges for PLC-INTERFACE, 6.2 mm versions, equipped with relay

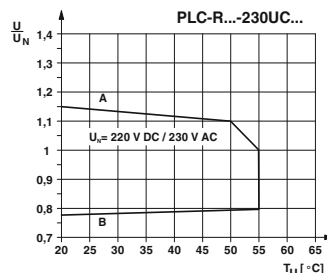
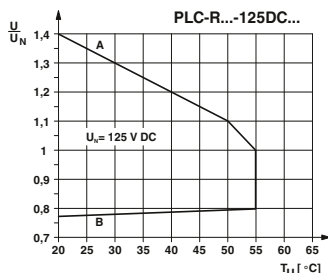
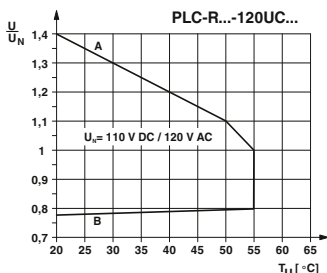
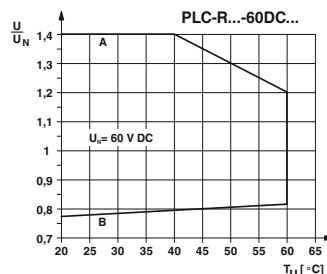
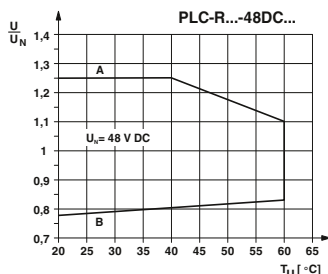
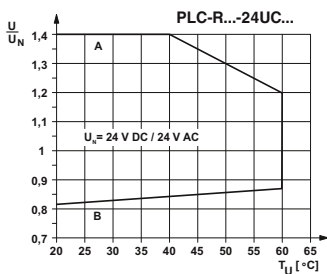
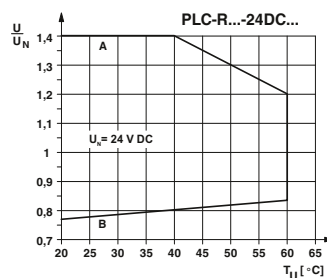
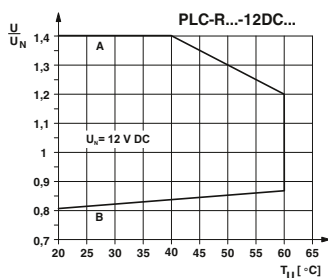

Operating voltage ranges for PLC-INTERFACE, 14 mm versions, equipped with relay

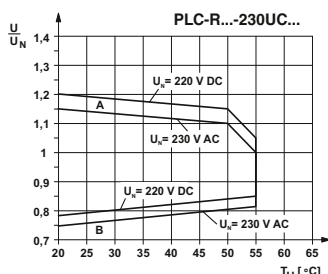
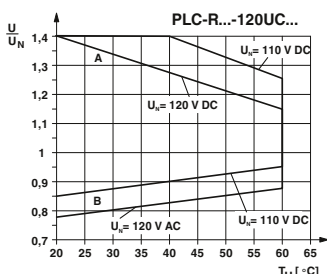
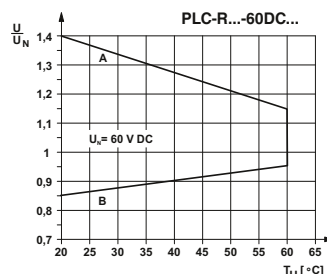
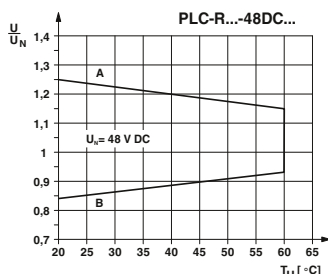
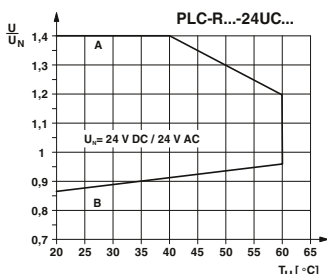
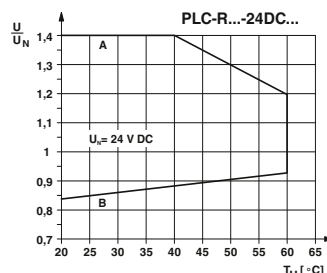
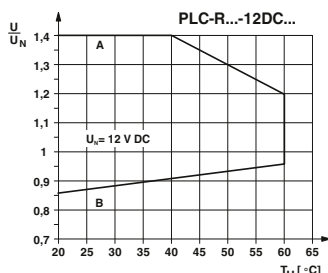

General conditions:
 Direct alignment in the block, all devices 100% operating time, horizontal or vertical mounting.

Curve A
 Maximum permissible continuous voltage U_{max} with limiting continuous current on the contact side (see relevant technical data).

Curve B
 Minimum permitted pick-up voltage U_{op} after pre-excitation¹⁾ (see relevant technical data).

¹⁾ **Pre-excitation:** relay has been operated in a thermally steady state at the ambient temperature T_A with nominal voltage U_N and limiting continuous current on the contact side (see relevant technical data) (warm coil). After being switched off for a short time, the relay must reliably pick up again at U_{op} . The U_{op} values for cold coils ($T_{coil} = T_A = 20^\circ\text{C}$) indicated by other manufacturers yield better values, but are not practical.

Plug-in 1-changeover-contact relays and 2-changeover contact relays

REL-MR...21

Permissible input voltage range for REL-MR...21

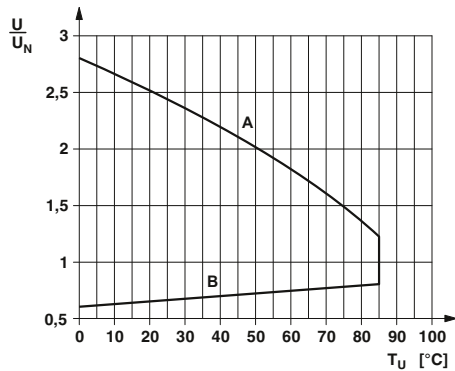

General conditions:

Direct alignment in the block, all devices 100% operating time, horizontal or vertical mounting.

Curve A

Maximum permissible continuous voltage U_{max} with limiting continuous current on the contact side (see relevant technical data).

Curve B

Minimum permitted pick-up voltage U_{op} after pre-excitation¹⁾ (see relevant technical data).

¹⁾ **Pre-excitation:** relay has been operated in a thermally steady state at the ambient temperature T_A with nominal voltage U_N and limiting continuous current on the contact side (see relevant technical data) (warm coil). After being switched off for a short time, the relay must reliably pick up again at U_{op} . The U_{op} values for cold coils ($T_{coil} = T_A = 20^\circ\text{C}$) indicated by other manufacturers yield better values, but are not practical.

REL-MR...21-21

Permissible input voltage range for REL-MR...21-21, REL-MR-24DC/11C, REL-MR...21HC

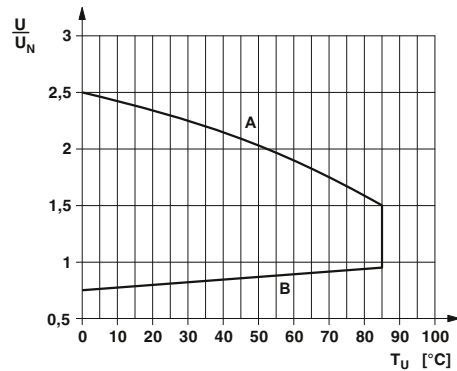

5 mm overall width

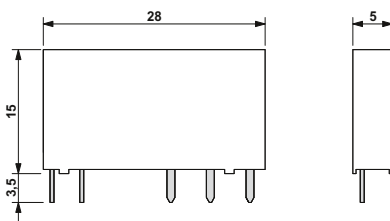

12.7 mm overall width

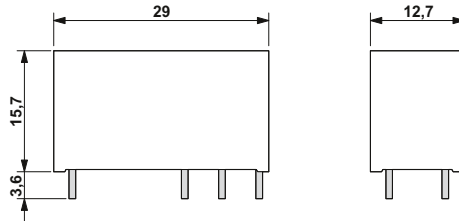

Perforations for assembly: view of the connections

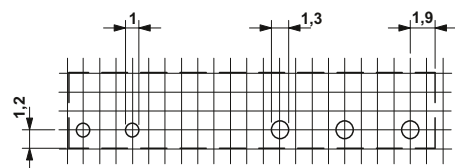

Pitch division: 1.25 mm and 1.27 mm

Perforations for assembly: view of the connections

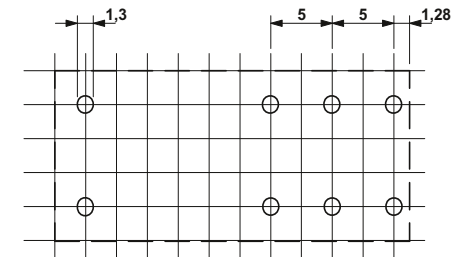

Pitch division: 2.5 mm

Plug-in solid-state relays

OPT...DC/24DC/2
OPT...DC/230AC/1

Derating curve for OPT...DC/24DC/2 and PLC-OS.../24DC/2 solid-state relays

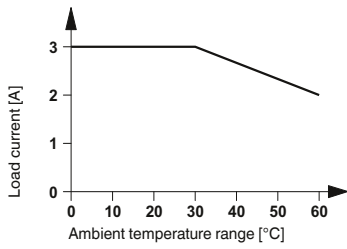

OPT...DC/24DC/5
OPT...DC/230AC/2

Derating curve for OPT...DC/24DC/5 and PLC-OS.../24DC/5/ACT solid-state relays

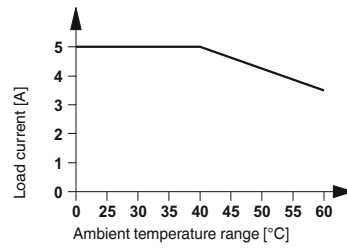

Derating curve for OPT...DC/230AC/1 and PLC-OS.../230AC/1 solid-state relays

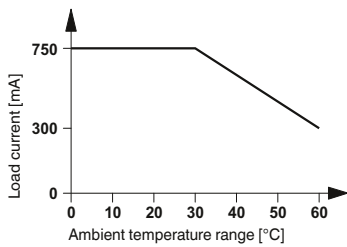

Derating curve for OPT...DC/230AC/2 and PLC-OS.../230AC/2/ACT solid-state relays

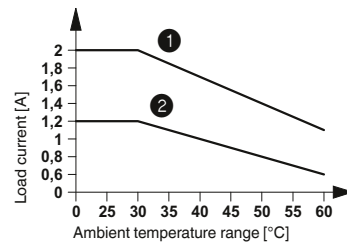

- ① Aligned with >10 mm spacing
- ② Aligned without spacing

5 mm overall width

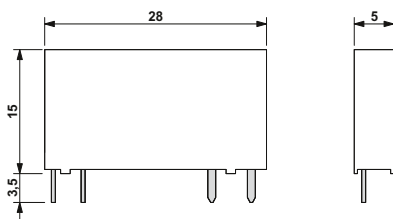

12.7 mm overall width

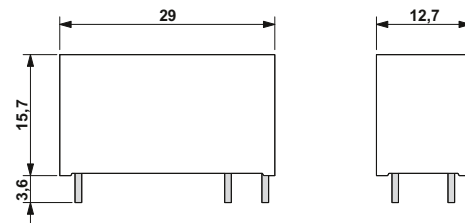

Electrical interrupting rating for PLC-INTERFACE

Electrical interrupting rating for PLC...21 with 1 PDT relay

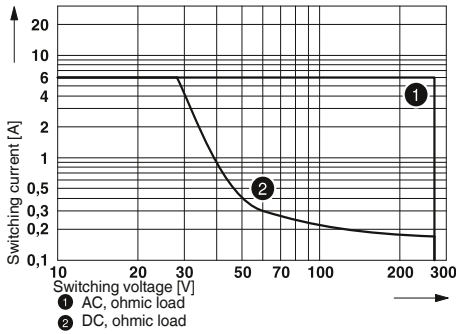

Electrical service life for PLC-INTERFACE

Electrical service life for PLC-R.../21...

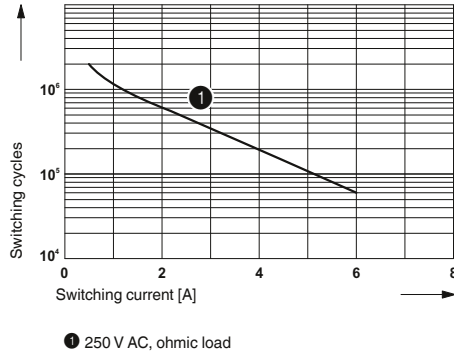

EMG-OV solid-state power relays

Derating curve for EMG 17-OV...48DC/2

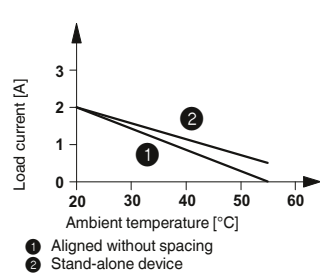

Electrical interrupting rating for PLC...21-21 with 2 PDT relays

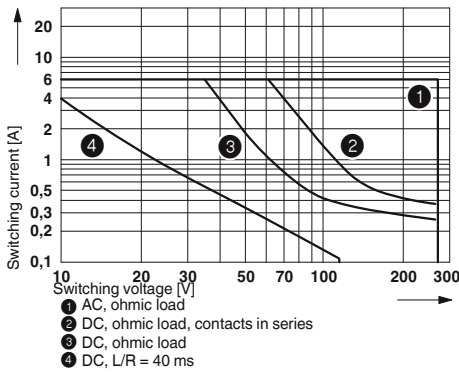

Electrical service life for PLC-R.../21-21...

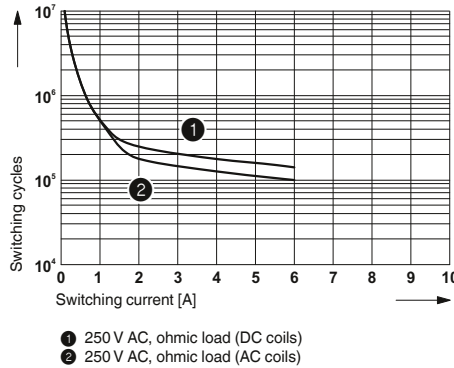

Electrical interrupting rating for PLC...11C/ACT for high inrush currents

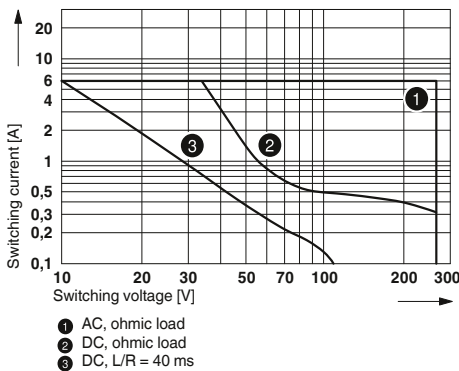

Electrical service life for PLC-R.../21HC...

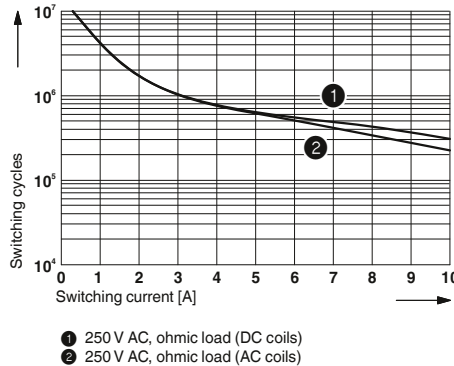

Electrical interrupting rating for PLC...21HC for high continuous currents

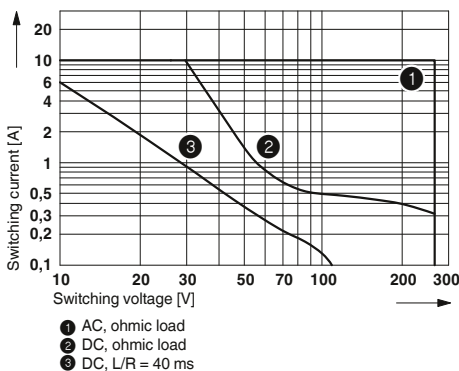

Relay modules

PLC-INTERFACE – Highly-compact relay modules

PLC-INTERFACE with two integrated relays

Relay module with two permanently soldered-in power relays

The advantages:

- 100% more channel density than the conventional 6.2 mm relay
- Two switching channels in a 6.2 mm housing
- Screw and Push-in connection technology

Notes:
Type of insulating housing: Polyamide PBT non-reinforced, color: gray.
Marking systems and mounting material See Catalog 3
See the website for more information on connection cross sections with ferrules.

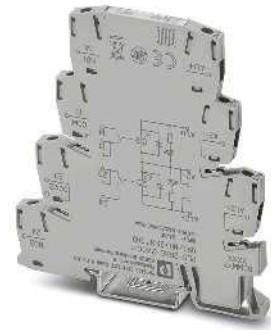

Relay module with two integrated, independent relays up to 3.5 A for high channel density

ERIC

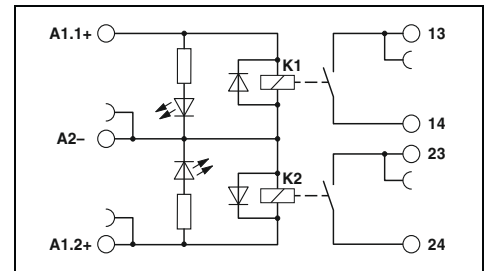

Technical data

Input data	①
Typical input current at U_N	7 [mA]
Response/release time at U_N	4 / 6 [ms]
Input circuit DC	Yellow LED, reverse polarity protection, free-wheeling diode
Output data	
Contact material	AgNi
Max. switching voltage	250 V AC / 30 V DC
Minimum switching voltage	24 V AC/DC
Limiting continuous current	3.5 A
Minimum switching current	5 mA
General data	
Test voltage input/output	3 kV AC (50 Hz, 1 min.)
Test voltage output/output	3 kV AC (50 Hz, 1 min.)
Ambient temperature (operation)	-20°C ... 60°C
Mechanical service life	2x 10 ⁷ cycles
Standards/regulations	IEC 60664, EN 50178
Connection data solid/stranded/AWG	0.14 - 2.5 mm ² / 0.14 - 2.5 mm ² / 26 - 14
Dimensions	6.2 mm / 80 mm / 86 mm
EMC note	Class A product, see page 583

Ordering data

Description	Input voltage U_N	Type	Order No.	Pcs./Pkt.
PLC INTERFACE, with screw connection				
①	24 V DC	PLC-2RSC-24DC/ 1	2987309	10
PLC-INTERFACE, with Push-in connection				
①	24 V DC	PLC-2RPT-24DC/1	2901639	10

Application example for PLC-2RS...24DC/1

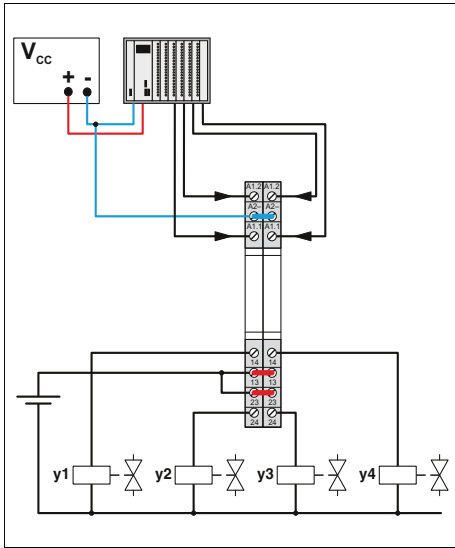

Operating voltage range

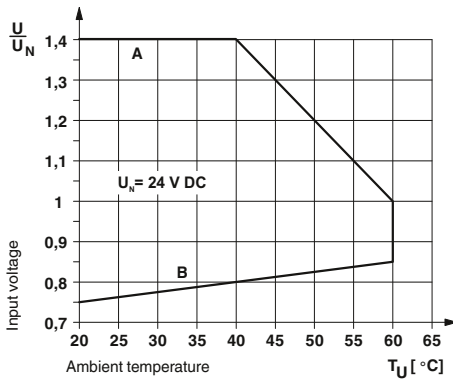

Interrupting rating

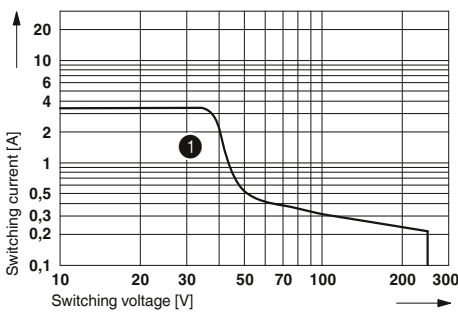

① DC, ohmic load

Relay modules

PLC-INTERFACE – Highly-compact relay modules

PLC-INTERFACE with manual switch and relay

Relay module with manual switch and integrated power relay for manual, zero, and automatic functions

The advantages are:

- Maximum switching current 6 A
- Width of only 6.2 mm
- Floating checkback contact
- Safe isolation in accordance with DIN EN 50178 between coil and contact
- Screw and Push-in connection technology

Notes:
Type of insulating housing: Polyamide PBT non-reinforced, color: gray.
Marking systems and mounting material See Catalog 3
For the protection of input and output, inductive loads must be dampened with an effective protection circuit.
Separating plate PLC-ATP is to be used in the following cases: always at the start and end of a PLC terminal strip, for voltages greater than 250 V (L1, L2, L3) between the same terminal points of neighboring modules (potential bridging then takes place with FBST 8-PLC... or FBST 500...) and with safe isolation between neighboring modules.
Module height: PLC-...-S/H = 90 mm; PLC-...-S/L: = 86 mm
PLC...-H - manual operation PLC...-L - operation using screwdriver
See the website for more information on connection cross sections with ferrules.



Relay module with manual switch and integrated relay

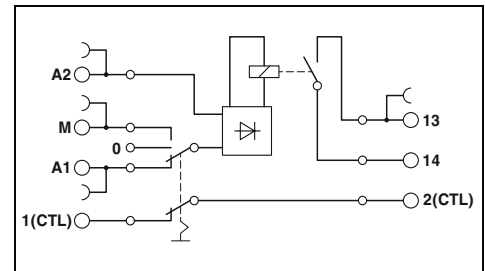

Application example for PLC-RS...24UC/1/S...

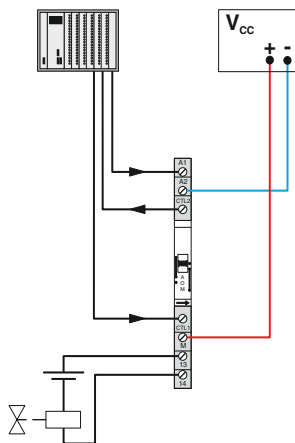

Permissible input voltage range for PLC-RS...24UC/1/S...

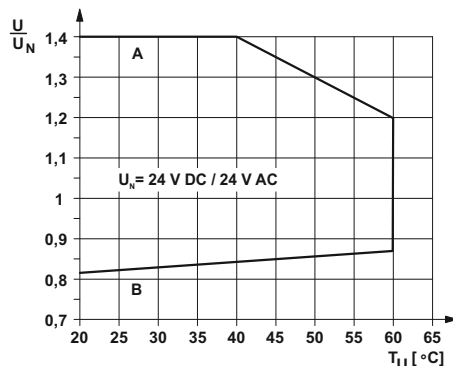

Curve A
Maximum continuous voltage when limiting continuous current = 6 A

Curve B
Minimum pick-up voltage for pre-excitation with U_N and limiting continuous current = 6 A

Input data		①
Typical input current at U _N	[mA]	11
Response/release time at U _N	[ms]	6 / 15
Input circuit AC/DC		Yellow LED, bridge rectifier
Output data		
Contact material		AgSnO
Max. switching voltage		250 V AC/DC
Minimum switching voltage		5 V (at 100 mA)
Limiting continuous current		6 A
Maximum switch-on current		On request
Minimum switching current		10 mA (at 12 V)
Feedback		
Operating mode "Automatic" floating		Max. 30 V AC/DC / 50 mA Min. 2 V AC/DC / 1 mA
General data		
Rated insulation voltage		250 V AC
Rated surge voltage		-
Ambient temperature (operation)		-20°C ... 60°C
Standards/regulations		IEC 60664, EN 50178
Degree of pollution/surge voltage category		2 / III
Connection data solid/stranded/AWG		0.14 - 2.5 mm ² / 0.14 - 2.5 mm ² / 26 - 14
Dimensions	W / H / D	6.2 mm / 80 mm / 90 mm
EMC note		Class A product, see page 583

Technical data

Ordering data

Description	Input voltage U _N
PLC INTERFACE, with screw connection	
①	24 V AC/DC
PLC-INTERFACE, with Push-in connection	
①	24 V AC/DC

Type	Order No.	Pcs./Pkt.
PLC-RSC- 24UC/ 1/S/H	2982236	10
PLC-RPT- 24UC/ 1/S/H	2900328	10

PLC-INTERFACE
with manual switch without relay

Switching module without relay for manual, zero, and automatic functions

The advantages:

- Width of only 6.2 mm
- Floating checkback contact
- Screw connection technology

Notes:
Type of insulating housing: Polyamide PBT non-reinforced, color: gray.
Marking systems and mounting material See Catalog 3
For the protection of input and output, inductive loads must be dampened with an effective protection circuit.
Separating plate PLC-ATP is to be used in the following cases: always at the start and end of a PLC terminal strip, for voltages greater than 250 V (L1, L2, L3) between the same terminal points of neighboring modules (potential bridging then takes place with FBST 8-PLC... or FBST 500...) and with safe isolation between neighboring modules.
Module height: PLC-...-S/H = 90 mm; PLC-...-S/L: = 86 mm
PLC...H - manual operation PLC...L - operation using screwdriver
See the website for more information on connection cross sections with ferrules.



Module with manual switch without relay

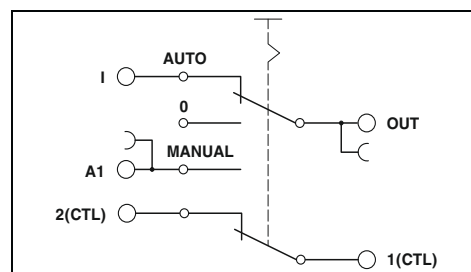

Technical data

Max. switching voltage
Minimum switching voltage
Maximum switch-on current
Minimum switching current
Switching cycles, max.

72 V DC
2 V DC
50 mA
1 mA
100 (at 72 V DC / 50 mA) / 10,000 (at 12 V DC / 100 mA)

Feedback
Operating mode "Automatic" floating

≤72 V DC / 50 mA

General data

Rated insulation voltage
Rated surge voltage
Insulation
Ambient temperature (operation)
Standards/regulations
Degree of pollution/surge voltage category

85 V AC
0.5 kV
Basic insulation
-20°C ... 60°C
IEC 60664, EN 50178
2 / III

Connection data solid/stranded/AWG

0.14 - 2.5 mm² / 0.14 - 2.5 mm² / 26 - 14

Dimensions

W / H / D

6.2 mm / 80 mm / 90 mm

Ordering data

Description
PLC INTERFACE, with screw connection

Type	Order No.	Pcs./Pkt.
PLC-SC-S/H	2980733	10

Application example for PLC-S...S...

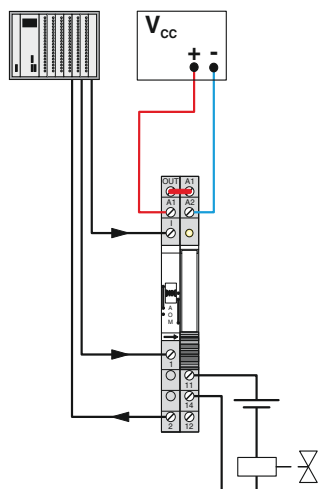

PLC-INTERFACE – Highly-compact relay modules

PLC-INTERFACE with one integrated solid-state relay

The slim 6.2 mm PLC housing with integrated electronics in various versions offers the following advantages:

- Option of bridging adjacent modules
- Status display
- Protection circuits in input and output
- Wear-resistant and bounce-free switching
- Integrated protection circuit
- DC outputs of up to 300 V DC/1 A or up to 24 V DC/10 A
- Electronic PDT output of up to 48 V DC/500 mA
- Screw and Push-in connection technology

Notes:	
Type of insulating housing: Polyamide PBT non-reinforced, color: gray.	
Marking systems and mounting material See Catalog 3	
For the protection of input and output, inductive loads must be dampened with an effective protection circuit.	
Separating plate PLC-ATP is to be used in the following cases: always at the start and end of a PLC terminal strip, for voltages greater than 250 V (L1, L2, L3) between the same terminal points of neighboring modules (potential bridging then takes place with FBST 8-PLC... or FBST 500...) and with safe isolation between neighboring modules.	
The housings of the following modules are open on one side: - PLC-O...-...-300DC/1 - PLC-O...-...-24DC/24DC/10/R	
See the website for more information on connection cross sections with ferrules.	



Solid-state relay module, DC output max. 300 V DC/1 A

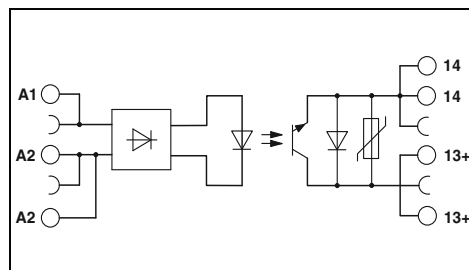

Input data	
Permissible range (with reference to U_N)	
Switching level (with reference to U_N)	1 signal ("H") 0 signal ("L")
Typical input current at U_N	[mA]
Transmission frequency f_{limit}	[Hz]
Alarm output	
Operating range	- / -
Output data	
Maximum/minimum switching voltage	300 V DC / 12 V DC
Limiting continuous current	1 A (see derating curve)
Voltage drop at maximum limiting continuous current	<500 mV
General data	
Rated insulation voltage	300 V
Rated surge voltage	Basic insulation
Ambient temperature (operation)	-25°C ... 60°C
Standards/regulations	IEC 60664, EN 50178
Connection data solid/stranded/AWG	0.14 - 2.5 mm ² / 0.14 - 2.5 mm ² / 26 - 14
Dimensions	W / H / D 6.2 mm / 80 mm / 86 mm
EMC note	Class A product, see page 583

Technical data								
①	②	③	④	⑤	⑥	⑦	⑧	⑨
0.8 - 1.2	0.8 - 1.2	0.8 - 1.2	0.8 - 1.2	0.8 - 1.2	0.8 - 1.2	0.8 - 1.1	0.8 - 1.1	0.8 - 1.1
≥0.8	≥0.8	≥0.8	≥0.8	≥0.8	≥0.8	≥0.8	≥0.8	≥0.8
≤0.4	≤0.4	≤0.4	≤0.4	≤0.4	≤0.4	≤0.4	≤0.4	≤0.4
15	6	8	5	5	3	5.6	8.4	
50	50	50	50	50	50	10	10	

Description	Input voltage U_N
PLC INTERFACE, with screw connection	
①	5 V DC
②	12 V DC
③	24 V DC
48 V DC ... 60 V DC	
④	60 V DC
⑤	110 V DC
⑥	220 V DC
⑦	120 V AC
⑧	230 V AC
PLC-INTERFACE, with Push-in connection	
①	5 V DC
②	12 V DC
③	24 V DC
48 V DC ... 60 V DC	
④	60 V DC
⑤	110 V DC
⑥	220 V DC
⑦	120 V AC
⑧	230 V AC

Ordering data			
Type	Order No.	Pcs./Pkt.	
PLC-OSC- 5DC/300DC/ 1	2980652	10	
PLC-OSC- 12DC/300DC/ 1	2980665	10	
PLC-OSC- 24DC/300DC/ 1	2980678	10	
PLC-OSC- 60DC/300DC/ 1	2980681	10	
PLC-OSC-110DC/300DC/ 1	2980694	10	
PLC-OSC-220DC/300DC/ 1	2980704	10	
PLC-OSC-120AC/300DC/ 1	2980717	10	
PLC-OSC-230AC/300DC/ 1	2980720	10	
PLC-OPT- 5DC/300DC/1	2900381	10	
PLC-OPT- 12DC/300DC/1	2900382	10	
PLC-OPT- 24DC/300DC/1	2900383	10	
PLC-OPT- 60DC/300DC/1	2900384	10	
PLC-OPT-110DC/300DC/1	2900385	10	
PLC-OPT-220DC/300DC/1	2900387	10	
PLC-OPT-120AC/300DC/1	2900388	10	
PLC-OPT-230AC/300DC/1	2900389	10	



Solid-state relay module, short-circuit-proof DC output max. 10 A, with feedback



Solid-state relay module, DC output max. 500 mA, with electronic changeover contact

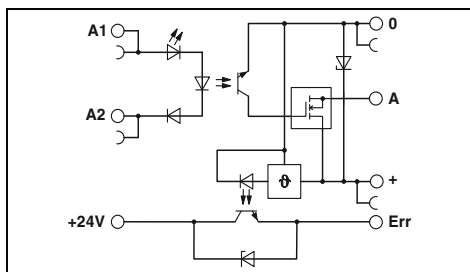

Technical data

- ③
- 0.8 - 1.2
- ≥0.8
- ≤0.4
- 3
- 100

3 V DC ... 33 V DC (high active) / 100 mA

33 V DC / 5 V DC
10 A (see derating curve)
≤50 mV

-
Basic insulation
-25°C ... 60°C
IEC 60664, EN 50178
0.14 - 2.5 mm² / 0.14 - 2.5 mm² / 26 - 14
6.2 mm / 80 mm / 86 mm
Class A product, see page 583

Ordering data

Type	Order No.	Pcs./Pkt.
PLC-OSC- 24DC/ 24DC/ 10/R	2982702	10
PLC-OPT- 24DC/ 24DC/10/R	2900398	10

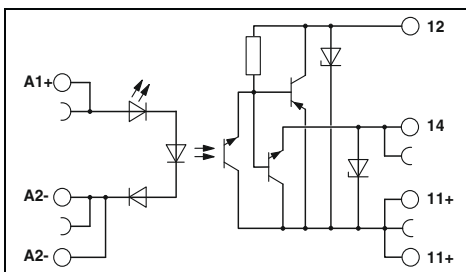

Technical data

- ③
- 0.8 - 1.2
- ≥0.8
- ≤0.4
- 3
- 1,000

- / -
48 V DC / 3 V DC
500 mA (see derating curve)
<1.2 V

300 V
Basic insulation
-25°C ... 60°C
IEC 60664, EN 50178
0.14 - 2.5 mm² / 0.14 - 2.5 mm² / 26 - 14
6.2 mm / 80 mm / 86 mm
Class A product, see page 583

Ordering data

Type	Order No.	Pcs./Pkt.
PLC-OSC- 24DC/ 48DC/500/W	2980636	10
PLC-OPT- 24DC/ 48DC/500/W	2900378	10

Derating curve for PLC...300DC/1

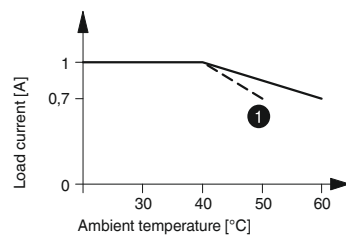

① For input voltages of 220 V DC and 230 V AC

Derating curve for PLC...24DC/24DC/10/R

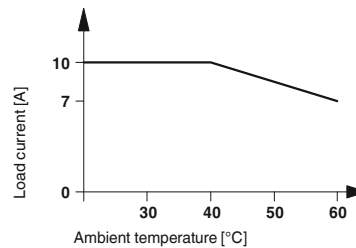

Derating curve for PLC...24DC/48DC/500/W

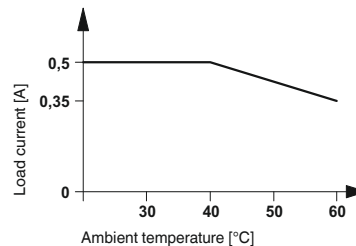

PLC-INTERFACE – Highly-compact relay modules

PLC-INTERFACE with one integrated solid-state relay

- 6.2 mm narrow solid-state relay for switching AC loads
- Status display
- Protection circuits in input and output
- Wear-free
- Switching capacity up to 230 V AC/2.4 A
- Screw and Push-in connection technology

Notes:

See the website for more information on connection cross sections with ferrules.



Solid-state relay module with additional floating terminal point, AC output max. 2.4 A

ERC

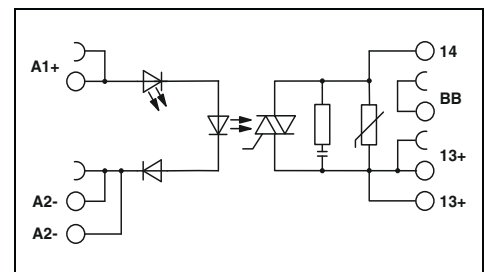

Technical data

Input data	①
Rated actuating voltage range with reference to U_c	0.8 - 1.2
Rated actuating current I_c	8 [mA]
Switching level (with reference to U_c)	1 signal ("H") >0.8 0 signal ("L") <0.4
Typical switch-on time at U_N	10 [ms]
Typical switch-off time at U_N	10 [ms]
Transmission frequency f_{limit}	10 [Hz]
Input circuit DC	Yellow LED, reverse polarity protection, surge protection
Output data	
Max. switching voltage	253 V AC
Minimum switching voltage	24 V AC
Maximum switch-on current	250 A (20 ms)
Minimum/maximum switching current	10 mA / 2.4 A (see derating)
Output protection	RCV circuit
Voltage drop at maximum limiting continuous current	<1 V
Leakage current in off state	<3 mA
Max. load value	340 A ² s (tp = 10 ms, at 25°C)
General data	
Rated insulation voltage	260 V AC
Rated surge voltage	4 kV
Insulation	Basic insulation
Ambient temperature (operation)	-25°C ... 60°C
Standards/regulations	DIN EN 50178
Degree of pollution/surge voltage category	2 / III
Connection data solid/stranded/AWG	0.14 - 2.5 mm ² / 0.14 - 2.5 mm ² / 26 - 14
Dimensions	W / H / D 6.2 mm / 80 mm / 86 mm
EMC note	Class A product, see page 583

Ordering data

Description	Rated actuating voltage U_c	Type	Order No.	Pcs./Pkt.
PLC INTERFACE, with screw connection	① 24 V DC	PLC-OSC- 24DC/230AC/2.4/ACT	2904631	10
PLC-INTERFACE, with Push-in connection	① 24 V DC	PLC-OPT- 24DC/230AC/2.4/ACT	2904632	10

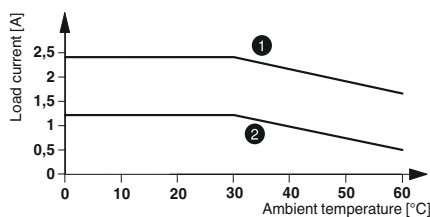

Load current as a function of the ambient temperature
Operating time: 100% operating factor

Relay modules

PLC-INTERFACE – Highly-compact relay modules

PLC-INTERFACE

Solid-state relays up to 100 kHz

Solid-state relays for the safe acquisition of short pulses.

- Status display
- Bridging options
- Limit frequency of up to 100 kHz
- Push-pull stage on output side
- Features a capacitor on the input side for interference suppression

Notes:
Type of insulating housing: Polyamide PBT non-reinforced, color: gray.
Marking systems and mounting material See Catalog 3
See the website for more information on connection cross sections with ferrules.



**Solid-state relay module,
DC output,
transmission frequency of 100 kHz**

ERIC

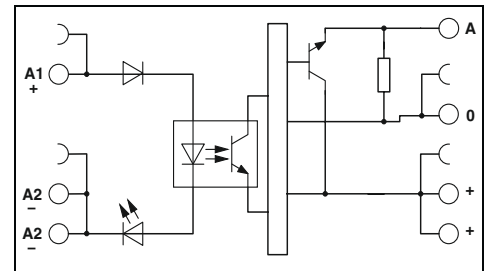

Technical data

		①	②
Input data			
Permissible range (with reference to U_N)		0.8 - 1.2	0.8 - 1.2
Switching level with reference to U_N		1 signal ("H") >0.8	>0.8
		0 signal ("L") <0.4	<0.4
Typical input current at U_N		[mA]	7 6
Typical switch-on time at U_N		[μs]	1.5 1.5
Typical switch-off time at U_N		[μs]	2 2
Transmission frequency f_{limit}		[kHz]	100 100
Input protection:		Yellow LED, reverse polarity protection, surge protection	
Output data			
Operating voltage range		4 V DC ... 30 V DC	
Limiting continuous current		50 mA	
Quiescent current		4.3 mA	
Residual voltage drop at "H"		<0.5 V	
Output circuit		3-conductor, ground-referenced	
Output protection		Reverse polarity protection, surge protection	
General data			
Test voltage input/output		2.5 kV _{rms} (50 Hz, 1 min.)	
Ambient temperature (operation)		-20°C ... 60°C	
Standards/regulations		DIN EN 50178	
Degree of pollution/surge voltage category		2 / II	
Connection data solid/stranded/AWG		0.14 - 2.5 mm ² / 0.14 - 2.5 mm ² / 26 - 14	
Dimensions		W / H / D 6.2 mm / 80 mm / 86 mm	
EMC note		Class A product, see page 583	

Ordering data

Description	Input voltage U_N	Type	Order No.	Pcs./Pkt.
Input solid-state relay with screw connection	① 5 V DC	PLC-OSC- 5DC/ 24DC/100KHZ	2902963	1
	② 24 V DC	PLC-OSC- 24DC/ 24DC/100KHZ	2902964	1
Input solid-state relay with Push-in connection	① 5 V DC	PLC-OPT- 5DC/ 24DC/100KHZ	2902969	1
	② 24 V DC	PLC-OPT- 24DC/24DC/100KHZ	2902970	1



Solid-state relay module,
DC push-pull output,
transmission frequency of 100 kHz



Solid-state relay module,
DC push-pull output,
transmission frequency of 100 kHz

ERC

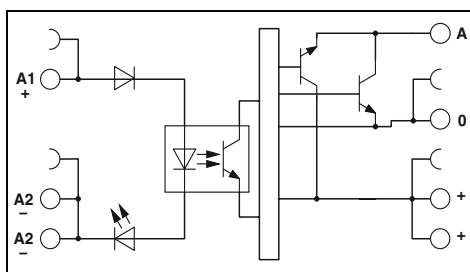

Technical data

①	②
0.5 - 1.2	0.8 - 1.2
>0.5	>0.8
<-0.3	<-0.4
8	8
1	1
2	2
100	100

Yellow LED, reverse polarity protection, surge protection

4 V DC ... 18 V DC

50 mA

8.5 mA

<1.2 V

3-conductor push-pull, ground referenced

Reverse polarity protection, surge protection

2.5 kV_{rms} (50 Hz, 1 min.)

-20°C ... 60°C

DIN EN 50178

2 / II

0.14 - 2.5 mm² / 0.14 - 2.5 mm² / 26 - 14

6.2 mm / 80 mm / 86 mm

Class A product, see page 583

Ordering data

Type	Order No.	Pcs./Pkt.
PLC-OSC- 5DC/ 5DC/100KHZ-G	2902965	1
PLC-OSC- 24DC/ 5DC/100KHZ-G	2902966	1
PLC-OPT- 5DC/ 5DC/100KHZ-G	2902971	1
PLC-OPT- 24DC/ 5DC/100KHZ-G	2902972	1

ERC

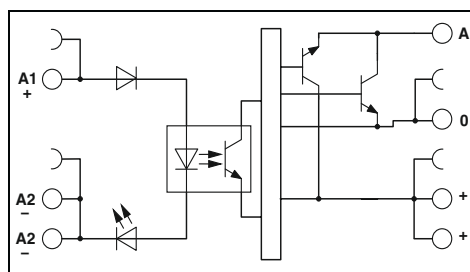

Technical data

①	②
0.5 - 1.2	0.8 - 1.2
>0.5	>0.8
<-0.3	<-0.4
8	8
1	1
2	2
100	100

Yellow LED, reverse polarity protection, surge protection

14 V DC ... 30 V DC

50 mA

15 mA

<2.2 V

3-conductor push-pull, ground referenced

Reverse polarity protection, surge protection

2.5 kV_{rms} (50 Hz, 1 min.)

-20°C ... 60°C

DIN EN 50178

2 / II

0.14 - 2.5 mm² / 0.14 - 2.5 mm² / 26 - 14

6.2 mm / 80 mm / 86 mm

Class A product, see page 583

Ordering data

Type	Order No.	Pcs./Pkt.
PLC-OSC- 5DC/ 24DC/100KHZ-G	2902967	1
PLC-OSC- 24DC/ 24DC/100KHZ-G	2902968	1
PLC-OPT- 5DC/24DC/100KHZ-G	2902973	1
PLC-OPT- 24DC/24DC/100KHZ-G	2902974	1

PLC-INTERFACE – Highly-compact relay modules

PLC-INTERFACE for the TTL signal at input

The PLC-BS...TTL/1 basic terminal block is controlled with a TTL (5 V) input signal. It is equipped with either a mechanical relay or a solid-state relay. The basic terminal block equipped with a robust miniature relay offers the following advantages:

- 6.2 mm slim design width
- Bridging options
- Status display
- RTIII degree of protection
- Safe isolation in accordance with EN 50178 (VDE 0160)
- 4 kV_{rms} electrical isolation between coil and contact
- Screw and Push-in connection technology

Notes:
Type of insulating housing: Polyamide PBT non-reinforced, color: gray.
Marking systems and mounting material See Catalog 3
See the website for more information on connection cross sections with ferrules.
If the specified maximum values for multi-layer contact relays are exceeded, the gold plating is destroyed. The maximum values of the power contact relay are then valid. This can result in a shorter service life than with a pure power contact.



1-N/O basic terminal block for assembly with relay for TTL (5 V)

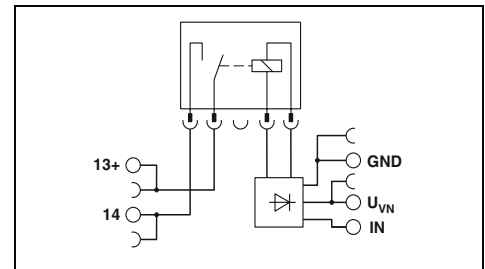

Technical data

Input data	5 V DC	0.9 ... 1.2
Rated control supply voltage U_{VN}		
Rated control supply voltage range with reference to U_{VN}		
Rated control supply current I_{VN}	41 mA	
Rated actuating voltage U_c (IN)	5 V DC (TTL)	
Rated actuating voltage range with reference to U_c	0.9 ... 1.2	
Rated actuating current I_c	2.5 mA	
Typical response time at U_c	4.5 ms	
Typical release time at U_c	3.5 ms	
Input circuit	Yellow LED, reverse polarity protection, surge protection	
Output data with:	REL-MR-4,5DC/21 AU	REL-MR-4,5DC/21
Contact type	Single contact, 1 N/O contact	Single contact, 1 N/O contact
Contact material	AgSnO, hard gold-plated	AgSnO
Max. switching voltage	30 V AC / 36 V DC	250 V AC/DC
Minimum switching voltage	100 mV (at 100 mA)	5 V (at 100 mA)
Limiting continuous current	50 mA	6 A
Maximum switch-on current	50 mA	On request
Minimum switching current	1 mA (at 24 V)	10 mA (at 12 V)
General data	250 V	
Rated insulation voltage	6 kV	
Rated surge voltage/insulation	-20°C ... 60°C	
Ambient temperature (operation)	2x 10 ⁷ cycles	
Mechanical service life	IEC 60664, EN 50178	
Air clearances and creepage distances between the power circuits		
Degree of pollution/overvoltage category	2 / III	
Mounting position/mounting	Any / in rows with zero spacing	
Connection data solid/stranded/AWG	0.14 - 2.5 mm ² / 0.14 - 2.5 mm ² / 26 - 14	
Dimensions	6.2 mm / 80 mm / 94 mm	
EMC note	Class A product, see page 583	

Ordering data

Type	Order No.	Pcs./Pkt.
PLC-BSC-TTL/1	2982689	10
PLC-BPT-TTL/1	2900458	10

Accessories

REL-MR 4,5DC/21AU	2961370	10
REL-MR- 4,5DC/21	2961367	10

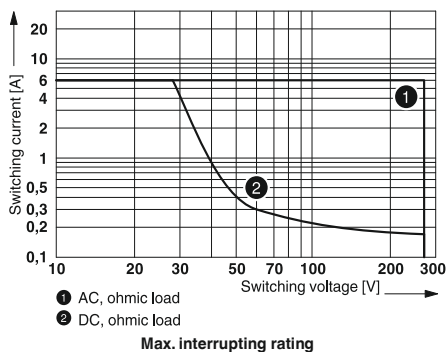

**PLC-INTERFACE
for the TTL signal at input**

The PLC-BS...TTL/1 basic terminal block is controlled with a TTL (5 V) input signal. It is equipped with either a mechanical relay or a solid-state relay. The basic terminal block equipped with a solid-state relay offers the following advantages:

- 6.2 mm slim design width
- Bridging options
- Status display
- IP67-protected solid-state relay electronic unit
- Switching capacity of up to 24 V DC/3 A
- Alternative input or power solid-state relay
- Wear-free and output-free
- Integrated protection circuit
- Integrated protective circuit
- 2.5 kV_{rms} electrical isolation between input and output
- Screw and Push-in connection technology

Notes:
Type of insulating housing: Polyamide PBT non-reinforced, color: gray.
Marking systems and mounting material See Catalog 3
See the website for more information on connection cross sections with ferrules.
If the specified maximum values for multi-layer contact relays are exceeded, the gold plating is destroyed. The maximum values of the power contact relay are then valid. This can result in a shorter service life than with a pure power contact.



**1-N/O basic terminal block
for assembly with relay for TTL (5 V)**

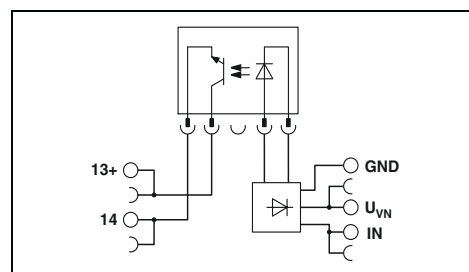

Technical data

Input data		
Rated control supply voltage U_{VN}	5 V DC	
Rated control supply voltage range with reference to U_{VN}	0.9 ... 1.2	
Rated control supply current I_{VN}	11.5 mA	
Rated actuating voltage U_c (IN)	5 V DC (TTL)	
Switching level 1 signal ("H") (TTL signal)	>2 V DC	
Switching level 0 signal ("L") (TTL signal)	<0.8 V DC	
Rated actuating current I_c	2.5 mA	
Typical response time/switch-on time at U_c	35 μ s	
Typical switch-off time at U_c	320 μ s	
Input circuit	Yellow LED, reverse polarity protection, surge protection	
Output data with:	OPT-5DC/48DC/100	OPT-5DC/24DC/2
Max. switching voltage	48 V DC	33 V DC
Minimum switching voltage	3 V DC	3 V DC
Limiting continuous current	100 mA	3 A
Output protection	Reverse polarity protection, surge protection	Reverse polarity protection, surge protection
Voltage drop at limiting continuous current	<1 V	<200 mV
General data		
Rated insulation voltage	250 V	
Rated surge voltage/insulation	6 kV/Basic isolation	
Ambient temperature (operation)	-20°C ... 60°C	
Air clearances and creepage distances between the power circuits	IEC 60664, EN 50178	
Degree of pollution/overvoltage category	2 / III	
Connection data solid/stranded/AWG	0.14 - 2.5 mm ² / 0.14 - 2.5 mm ² / 26 - 14	
Dimensions	W / H / D 6.2 mm / 80 mm / 94 mm	
EMC note	Class A product, see page 583	

Ordering data

Description	Type	Order No.	Pcs./Pkt.
PLC-INTERFACE			
with screw connection	PLC-BSC-TTL/1	2982689	10
with Push-in connection	PLC-BPT-TTL/1	2900458	10

Accessories

Pluggable solid-state relays			
Solid-state input relays	OPT-5DC/48DC/100	2967992	10
Solid-state power relays	OPT-5DC/24DC/2	2967989	10

PLC-INTERFACE – Highly-compact relay modules

PLC-INTERFACE for the TTL signal at output

The PLC-OS...24DC/TTL with a built-in solid-state relay can be used for fast and wear-free switching of TTL (5 V) signals.

The module offers the following advantages:

- Switching capacity TTL (5 V), fan out = 1
- 6.2 mm slim design width
- Bridging options
- Status display
- Integrated protection circuit
- Integrated protective circuit
- Screw and Push-in connection technology

Notes:
Type of insulating housing: Polyamide PBT non-reinforced, color: gray.
Marking systems and mounting material See Catalog 3
See the website for more information on connection cross sections with ferrules.



Input solid state relays with TTL (5 V) output

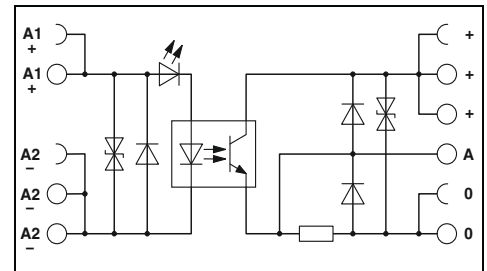

Technical data

Input data		
Rated actuating voltage U_c	24 V DC	
Rated actuating voltage range with reference to U_c	0.8 ... 1.2	
Switching level 1 signal ("H")	>0.8	
Switching level 0 signal ("L")	<0.4	
Rated actuating current I_c	3.4 mA	
Typical switch-on time at U_c	35 μ s	
Typical switch-off time at U_c	35 μ s	
Transmission frequency f_{limit}	1 kHz	
Input circuit DC	Yellow LED, reverse polarity protection, surge protection	
Output data with:		
Rated control supply voltage U_s	5 V DC	
Rated control supply voltage range with reference to U_s	0.9 ... 1.2	
Limiting continuous current	A TTL load (Fan out = 1)/50 mA for switching mode	
Output protection	Reverse polarity protection, surge protection	
Voltage drop at maximum limiting continuous current	<80 mV	
General data		
Rated insulation voltage	250 V DC	
Rated surge voltage	4 kV	
Insulation	Basic insulation	
Ambient temperature (operation)	-25°C ... 60°C	
Air clearances and creepage distances between the power circuits	IEC 60664, EN 50178	
Degree of pollution/surge voltage category	2 / III	
Connection data solid/stranded/AWG	0.14 - 2.5 mm ² / 0.14 - 2.5 mm ² / 26 - 14	
Dimensions	6.2 mm / 80 mm / 86 mm	
EMC note	Class A product, see page 583	
Ordering data		
Type	Order No.	Pcs./Pkt.
PLC-OSC- 24DC/TTL	2982728	10
PLC-OPT- 24DC/TTL	2900363	10

Derating curve for PLC-OSP...24DC/3RW

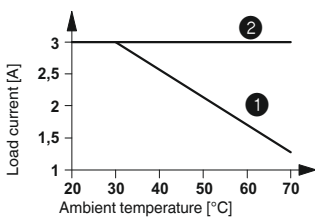

- ① Aligned without spacing
- ② Aligned with 20 mm spacing

Derating curve for PLC-OSP...110DC/3RW

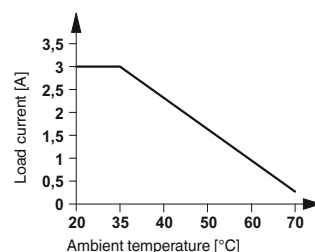

PLC-INTERFACE
with solid-state relays
for railway applications

The PLC-OSP...RW interface modules are suitable for use in accordance with DIN EN 50155 (VDE 0115 Part 200) "Railway applications – Electronic equipment used on rolling stock".

The advantages:

- Temperature range -25°C to +70°C
- Input voltage range 0.7-1.25 x U_N
- Shock resistance in accordance with DIN 50155 (requirements in accordance with EN 61373)
- Spring cage and Push-in connection method



Solid-state relay module,
DC output max. 3 A



Solid-state relay module,
DC output max. 110 V DC/3 A

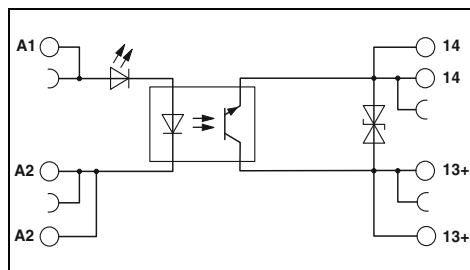

Technical data

	①	②	③	④	⑤	⑥
Permissible range (with reference to U _N)	0.7 - 1.25	0.7 - 1.25	0.7 - 1.25	0.7 - 1.25	0.7 - 1.25	0.7 - 1.25
Switching level (with reference to U _N)	1 signal ("H") ≥0.6	0 signal ("L") ≤0.3	≥0.6	≤0.3	≥0.6	≤0.3
Typical input current at U _N	[mA]	8.5	3			
Typical switch-on time at U _N	[ms]	0.04	0.08			
Typical switch-off time at U _N	[ms]	0.2	0.6			
Transmission frequency f _{limit}	[Hz]	300	100			
Input circuit DC	Yellow LED, reverse polarity protection					

Output data	
Max. switching voltage	33 V DC
Minimum switching voltage	3 V DC
Limiting continuous current	3 A (see derating curve)
Output protection	Reverse polarity protection, surge protection
Voltage drop at maximum limiting continuous current	<200 mV

General data	
Rated insulation voltage	250 V
Rated surge voltage	Basic insulation
Ambient temperature (operation)	-25°C ... 70°C
Standards/regulations	IEC 60664, EN 50178
Degree of pollution/surge voltage category	2 / III

Connection data solid/stranded/AWG	
Dimensions	0.14 - 2.5 mm ² / 0.14 - 2.5 mm ² / 26 - 14
EMC note	6.2 mm / 80 mm / 86 mm Class A product, see page 583

Ordering data

Description	Input voltage U _N	Type	Order No.	Pcs./Pkt.
PLC-INTERFACE, with Push-in connection	① 24 V DC	PLC-OPT- 24DC/ 24DC/3RW	2900379	10
	② 36 V DC			
	③ 48 V DC			
	④ 72 V DC	PLC-OPT-110DC/ 24DC/3RW	2900380	10
	⑤ 96 V DC			
	⑥ 110 V DC			

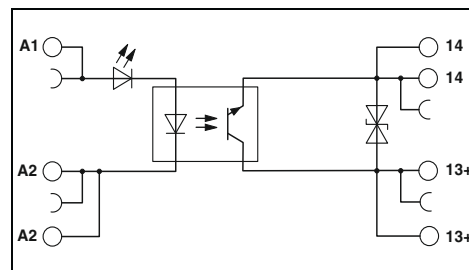

Technical data

	①	②	③	④	⑤	⑥
Permissible range (with reference to U _N)	0.7 - 1.25	0.7 - 1.25	0.7 - 1.25	0.7 - 1.25	0.7 - 1.25	0.7 - 1.25
Switching level (with reference to U _N)	1 signal ("H") ≥0.6	0 signal ("L") ≤0.3	≥0.6	≤0.3	≥0.6	≤0.3
Typical input current at U _N	[mA]	12	12	5.5	5.5	5.5
Typical switch-on time at U _N	[ms]	0.4	0.4	0.04	0.04	0.4
Typical switch-off time at U _N	[ms]	0.2	0.1	0.2	0.2	0.2
Transmission frequency f _{limit}	[Hz]	50	50	300	300	300
Input circuit DC	Yellow LED, reverse polarity protection, surge protection					

Output data	
Max. switching voltage	140 V DC
Minimum switching voltage	12 V DC
Limiting continuous current	3 A (see derating curve)
Output protection	Reverse polarity protection, surge protection
Voltage drop at maximum limiting continuous current	<150 mV

General data	
Rated insulation voltage	160 V DC
Rated surge voltage	Basic insulation
Ambient temperature (operation)	-25°C ... 70°C
Standards/regulations	IEC 60664, EN 50178
Degree of pollution/surge voltage category	2 / III

Connection data solid/stranded/AWG	
Dimensions	0.14 - 2.5 mm ² / 0.14 - 2.5 mm ² / 26 - 14
EMC note	6.2 mm / 80 mm / 86 mm Class A product, see page 583

Ordering data

Description	Input voltage U _N	Type	Order No.	Pcs./Pkt.
PLC-INTERFACE, with Push-in connection	24 V DC	PLC-OPT- 24DC/110DC/3RW	2900391	10
		PLC-OPT- 36DC/110DC/3RW	2900392	10
		PLC-OPT- 48DC/110DC/3RW	2900393	10
	72 V DC	PLC-OPT- 72DC/110DC/3RW	2900394	10
		PLC-OPT- 96DC/110DC/3RW	2900395	10
		PLC-OPT-110DC/110DC/3RW	2900396	10

PLC-INTERFACE – Highly-compact relay modules

PLC-INTERFACE for railway applications

Relay modules with extended input voltage and temperature range, specifically for use in railway applications

- The advantages:
- Temperature range -25°C to $+70^{\circ}\text{C}$
 - Input voltage range 0.7 to $1.25 \times U_N$
 - Vibration and shock resistance to EN 50155
 - Safe isolation in accordance with DIN EN 50178 between coil and contact
 - Push-in connection technology

Notes:
Type of insulating housing: Polyamide PBT non-reinforced, color: gray.
Marking systems and mounting material See Catalog 3
Separating plate PLC-ATP must be installed for voltages larger than 250 V (L1, L2, L3) between identical terminal blocks in adjacent modules. Potential bridging is then carried out with FBST 8-PLC... or FBST 500....
If the specified maximum values for multi-layer contact relays are exceeded, the gold plating is destroyed. The maximum values of the power contact relay are then valid. This can result in a shorter service life than with a pure power contact.



Basic terminal block for assembly with 1-changeover-contact relay up to 6 A

ERIE DNV GL

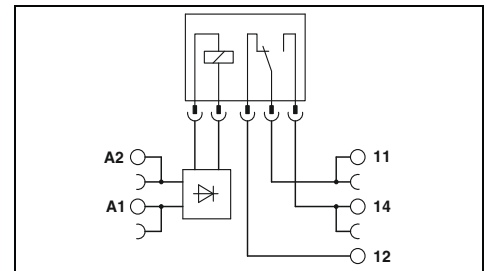

Permissible input voltage range for PLC-BSP-24DC/21RW (with REL-MR-18DC/21... relay)

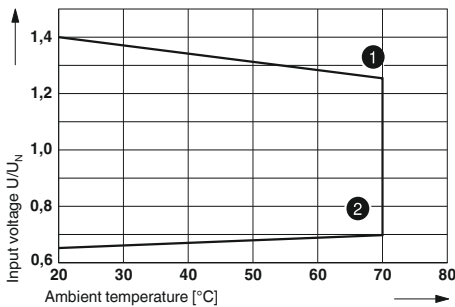

- ① Maximum continuous voltage when limiting continuous current = 3 A
- ② Minimum pick-up voltage for pre-excitation with U_N and limiting continuous current = 3 A

Electrical interrupting rating for PLC...21 with 1 PDT relay

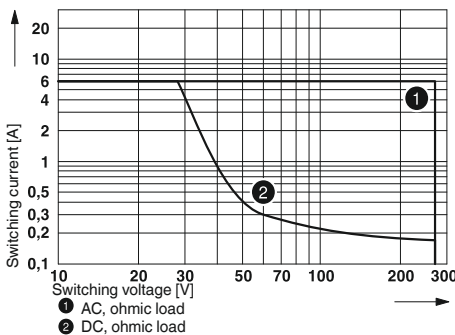

- ① AC, ohmic load
- ② DC, ohmic load

Input data	
Nominal input voltage U_N	
Permissible range (with reference to U_N)	
Typical input current at U_N	
Typical response time at U_N	
Typical release time at U_N	
Input circuit	
Output data with:	
Contact type	
Contact material	
Max. switching voltage	
Minimum switching voltage	
Limiting continuous current	
Maximum switch-on current	
Minimum switching current	
General data	
Test voltage input/output	
Ambient temperature (operation)	
Mechanical service life	
Standards/regulations	
Degree of pollution/overvoltage category	
Connection data solid/stranded/AWG	
Dimensions	W / H / D
EMC note	

Technical data	
24 V DC	
See diagram	
12 mA	
5 ms	
8 ms	
Yellow LED, reverse polarity protection, free-wheeling diode	
REL-MR-18DC/21	REL-MR-18DC/21AU
Single contact, 1-PDT	Single contact, 1-PDT
AgSnO	AgSnO, hard gold-plated
250 V AC/DC	30 V AC / 36 V DC
5 V (at 100 mA)	100 mV (at 10 mA)
3 A	50 mA
On request	50 mA
10 mA (at 12 V)	1 mA (at 24 V)
General data	
4 kV (50 Hz, 1 min.)	
-25°C ... 70°C	
2×10^7 cycles	
IEC 60664, EN 50178	
3 / III	
0.14 - 2.5 mm ² / 0.14 - 2.5 mm ² / 26 - 14	
6.2 mm / 80 mm / 94 mm	
Class A product, see page 583	

Description	Voltage U_N
PLC-INTERFACE basic terminal block, for pluggable miniature relay with Push-in connection	24 V DC

Pluggable miniature relays
REL-MR- 18DC/21
REL-MR- 18DC/21AU

Ordering data		
Type	Order No.	Pcs./Pkt.
PLC-BPT- 24DC/21RW	2900261	10

Accessories		
REL-MR- 18DC/21	2961383	10
REL-MR- 18DC/21AU	2961493	10

PLC-INTERFACE
for railway applications

Relay module for input voltages with a nominal frequency of 16.7 Hz

The advantages:

- Input nominal frequency 16.7 Hz
- Vibration and shock resistance to EN 50155
- Safe isolation in accordance with DIN EN 50178 between coil and contact
- Push-in connection technology

Notes:
Type of insulating housing: Polyamide PBT non-reinforced, color: gray.
Marking systems and mounting material See Catalog 3
Separating plate PLC-ATP must be installed for voltages larger than 250 V (L1, L2, L3) between identical terminal blocks in adjacent modules. Potential bridging is then carried out with FBST 8-PLC... or FBST 500....
If the specified maximum values for multi-layer contact relays are exceeded, the gold plating is destroyed. The values in parentheses then apply for further operation. This can result in a shorter service life than with a pure power contact.
See the website for more information on connection cross sections with ferrules.



2-changeover-contact relay module
for 16.7 Hz input frequency,
max. 2 x 6 A

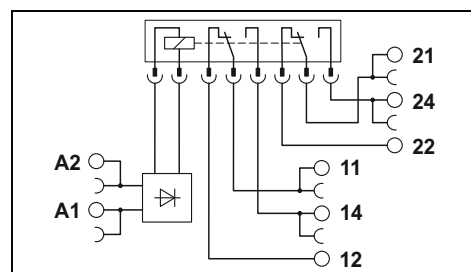

Technical data

Input data	
Nominal input voltage U_N	230 V AC
Input nominal frequency	16.67 Hz
Permissible range (with reference to U_N)	See diagram
Typical response time at U_N	20 ms
Typical release time at U_N	60 ms
Input circuit	Yellow LED, bridge rectifier
Output data	
Contact type	2 PDT
Contact material	AgNi, hard gold-plated
Max. switching voltage	30 V AC / 36 V DC (250 V AC/DC)
Minimum switching voltage	100 mV (5 V AC/DC)
Limiting continuous current	50 mA (6 A)
Maximum switch-on current	50 mA (8 A)
Minimum switching current	1 mA (10 mA)
General data	
Test voltage input/output	6 kV
Ambient temperature (operation)	-25°C ... 55°C
Mechanical service life	Approx. 3×10^7 cycles
Standards/regulations	IEC 60664, EN 50178
Degree of pollution/overvoltage category	2 / III
Connection data solid/stranded/AWG	0.14 - 2.5 mm ² / 0.14 - 2.5 mm ² / 26 - 14
Dimensions	14 mm / 80 mm / 94 mm
EMC note	Class A product, see page 583

Permissible input voltage range
for PLC-RSP-230UC/21-21AU/RWF

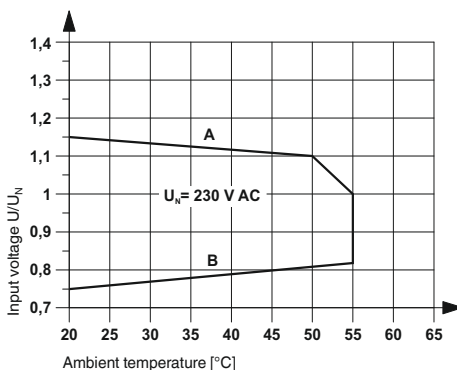

Curve A
Maximum continuous voltage when limiting continuous current = 6 A

Curve B
Minimum pick-up voltage for pre-excitation with U_N and limiting continuous current = 6 A

Description	Voltage U_N	Type	Order No.	Pcs./Pkt.
PLC-INTERFACE with Push-in connection	230 V AC	PLC-RPT-230UC/21-21AU/RWF	2900345	10

PLC-INTERFACE – Highly-compact relay modules

PLC-INTERFACE for railway applications

Relay modules with extended input voltage and temperature range, specifically designed for railway applications

The advantages:

- Certified to EN 50155
- Optimum relay operation, thanks to wide-range electronics
- Temperature range -40 to +70°C (short-term 85°C)
- Input voltage range 0.7 to 1.25 x U_N (short-term 1.4 x U_N)
- Vibration and shock resistance to EN 50155
- Safe isolation in accordance with DIN EN 50178 between coil and contact
- Push-in connection technology

Notes:
Type of insulating housing: Polyamide PBT non-reinforced, color: gray.
Marking systems and mounting material See Catalog 3
Separating plate PLC-ATP must be installed for voltages larger than 250 V (L1, L2, L3) between identical terminal blocks in adjacent modules. Potential bridging is then carried out with FBST 8-PLC... or FBST 500....
If the specified maximum values for multi-layer contact relays are exceeded, the gold plating is destroyed. The maximum values of the power contact relay are then valid. This can result in a shorter service life than with a pure power contact.
Electrical service life diagrams, see page 402
See the website for more information on connection cross sections with ferrules.



1-changeover-contact relay module,
6 A, maximum

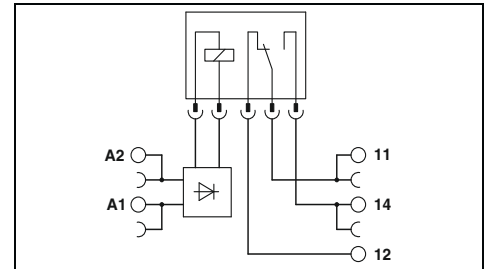

Technical data

Input data	①	②	③
Permissible range (with reference to U _N)	0.7 - 1.25		0.7 - 1.25
Typical input current at U _N	[mA] 9	3	2
Typical response time at U _N	[ms] 4	4	4
Typical release time at U _N	[ms] 4	4	4
Input protection:	Yellow LED, bridge rectifier, free-wheeling diode		
Output data	1 PDT		1 PDT
Contact type	AgSnO		AgSnO, hard gold-plated
Contact material	250 V AC/DC		30 V AC / 36 V DC
Max. switching voltage	5 V (at 100 mA)		100 mV (at 10 mA)
Minimum switching voltage	6 A		50 mA
Limiting continuous current	10 A (4 s)		50 mA
Maximum switch-on current	10 mA (at 12 V)		1 mA (at 24 V)
Minimum switching current			
General data	4 kV _{rms} (50 Hz, 1 min.)		
Test voltage (winding/contact)	-40°C ... 70°C (temperature class TX)		
Ambient temperature (operation)	Approx. 2x 10 ⁷ cycles		
Mechanical service life	EN 50155 (VDE 0115 part 200), EN 50178, EN 61373, EN 50121		
Standards/regulations			
Connection data solid/stranded/AWG	0.14 - 2.5 mm ² / 0.14 - 2.5 mm ² / 26 - 14		
Dimensions	W / H / D 6.2 mm / 80 mm / 94 mm		
EMC note	Class A product, see page 583		

Ordering data

Description	Input voltage U _N	Type	Order No.	Pcs./Pkt.
PLC-INTERFACE, with power contact with Push-in connection	① 24 V DC	PLC-RPT-24UC/21/RW	2900318	10
	② 72 V DC	PLC-RPT-72UC/21/RW	2900319	10
	③ 110 V DC	PLC-RPT-110UC/21/RW	2900320	10
PLC-INTERFACE, with hard gold-plated contact with Push-in connection	① 24 V DC	PLC-RPT-24UC/21AU/RW	2900321	10
	② 72 V DC	PLC-RPT-72UC/21AU/RW	2900322	10
	③ 110 V DC	PLC-RPT-110UC/21AU/RW	2900323	10

PLC-INTERFACE – Highly-compact relay modules



**2-changeover-contact relay module,
2 x 6 A, maximum**



**1-changeover-contact relay module,
max. 10 A**

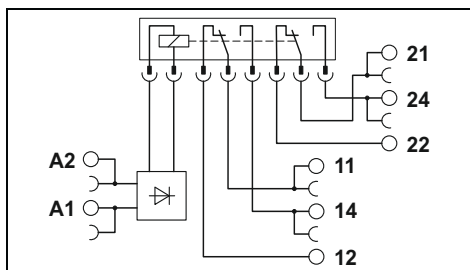

Technical data

①	②	③
0.7 - 1.25	0.7 - 1.25	0.7 - 1.25
20	6	4.5
5	5	5
11	11	11

Yellow LED, bridge rectifier, free-wheeling diode

2 PDT	2 PDT
AgNi	AgNi, hard gold-plated
250 V AC/DC	30 V AC / 36 V DC
5 V (at 10 mA)	100 mV (at 10 mA)
6 A	50 mA
15 A (300 ms)	50 mA
10 mA (at 5 V)	1 mA (at 24 V)

5 kV_{rms} (50 Hz, 1 min.)
 -40°C ... 70°C (temperature class TX)
 Approx. 3x 10⁷ cycles
 EN 50155 (VDE 0115 part 200), EN 50178, EN 61373, EN 50121

0.14 - 2.5 mm² / 0.14 - 2.5 mm² / 26 - 14
 14 mm / 80 mm / 94 mm
 Class A product, see page 583

Ordering data

Type	Order No.	Pcs./Pkt.
PLC-RPT- 24UC/21-21/RW	2900346	10
PLC-RPT- 72UC/21-21/RW	2900347	10
PLC-RPT-110UC/21-21/RW	2900348	10
PLC-RPT- 24UC/21-21AU/RW	2900349	10
PLC-RPT- 72UC/21-21AU/RW	2900350	10
PLC-RPT-110UC/21-21AU/RW	2900351	10

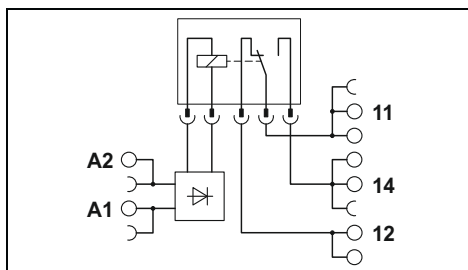

Technical data

①	②	③
0.7 - 1.25	0.7 - 1.25	0.7 - 1.25
20	6	4.5
5	5	5
11	11	11

Yellow LED, bridge rectifier, free-wheeling diode

1 PDT	1 PDT
AgNi	AgNi, hard gold-plated
250 V AC/DC	30 V AC / 36 V DC
12 V (at 10 mA)	10 A (with inserted bridge 2967691)
10 A (with inserted bridge 2967691)	30 A (300 ms)
30 A (300 ms)	10 mA (at 12 V)

5 kV_{rms} (50 Hz, 1 min.)
 -40°C ... 70°C (temperature class TX)
 Approx. 3x 10⁷ cycles
 EN 50155 (VDE 0115 part 200), EN 50178, EN 61373, EN 50121

0.14 - 2.5 mm² / 0.14 - 2.5 mm² / 26 - 14
 14 mm / 80 mm / 94 mm
 Class A product, see page 583

Ordering data

Type	Order No.	Pcs./Pkt.
PLC-RPT- 24UC/21HC/RW	2900324	10
PLC-RPT- 72UC/21HC/RW	2900325	10
PLC-RPT-110UC/21HC/RW	2900326	10

Derating curve for

PLC-RSP...21/RW
 PLC-RSP...21AU/RW
 PLC-RSP...21-21/RW
 PLC-RSP...21-21AU/RW

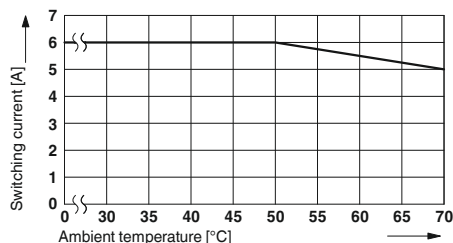

Interrupting rating for PLC-RSP...UC/21RW

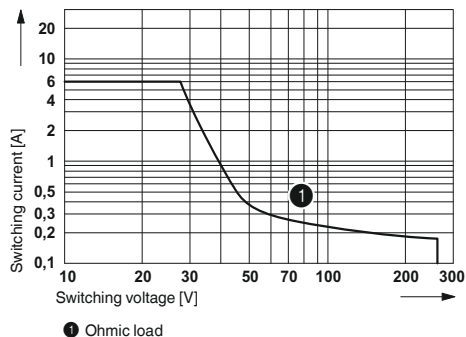

Interrupting rating for PLC-RSP...UC/21-21/RW

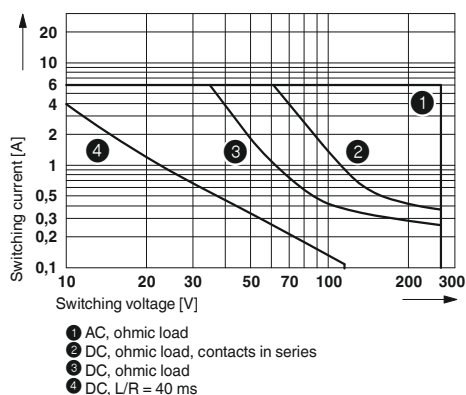

Interrupting rating for PLC-RSP...UC/21HC/RW

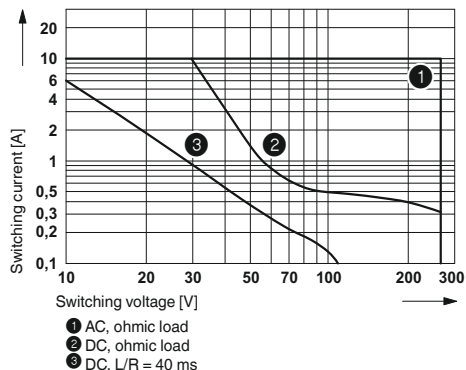

PLC-INTERFACE – Highly-compact relay modules

PLC electronic sensor terminal blocks for NAMUR proximity sensors

The electronic sensor terminal block, PLC-...-EIK 1-SVN from Phoenix converts the changeable resistance of a NAMUR sensor unit into a digital signal that can be read by all PLCs.

In addition, the electronics monitors the sensor side for a short circuit or open circuit and indicates these errors via an integrated LED.

Due to a corresponding resistance circuit, the PLC-...-EIK 1-SVN can be used to monitor all mechanical switches (N/C contact or N/O contact) for short-circuits and/or wire break.

In addition to a high packing density, this switching amplifier features the following:

- Regulated power supply for the NAMUR proximity switch
- 24 V/50 mA digital output for directly connecting programmable logic controls
- Connection option for PLC-V8 adapter
- Screw and Push-in connection technology

Notes:
Type of insulating housing: Polyamide PBT non-reinforced, color: gray.
Marking systems and mounting material See Catalog 3
Separating plate PLC-ATP is to be used in the following cases: always at the start and end of a PLC terminal strip, for voltages greater than 250 V (L1, L2, L3) between the same terminal points of neighboring modules (potential bridging then takes place with FBST 8-PLC... or FBST 500...) and with safe isolation between neighboring modules.
See the website for more information on connection cross sections with ferrules.



For inductive proximity sensors in accordance with NAMUR, with light indicators for sensor signal and faults,

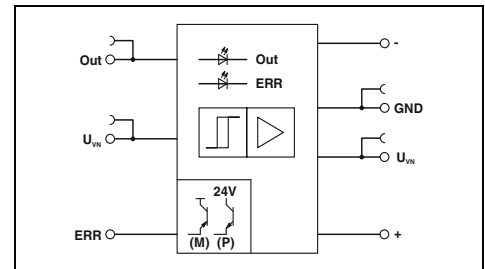

Application 1

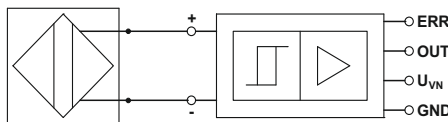

NAMUR initiator

Application 2

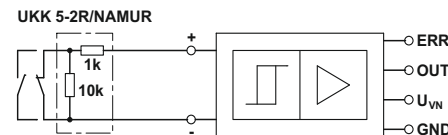

Limit switch

Initiator state	Switching level		LED	
	OUT	ERR	Green	Red
Conductive	L	L	OFF	OFF
Blocking	H	L	ON	OFF
Short circuit	L	H	OFF	ON
Open circuit	L	H	OFF	ON

Supply	Input supply nominal voltage U_{VN} Typical input current at U_{VN} Transmission frequency f_{limit} Input circuit
Control circuit	No-load voltage Switching points in accordance with EN 60947-5-6:
Protective circuit	Alarm output
Operating voltage range (positive switching)	Limiting continuous current Voltage drop at maximum limiting continuous current
Output protection	Signal output Limiting continuous current Voltage drop U_R at maximum limiting continuous current
General data	Rated insulation voltage Rated surge voltage Insulation Ambient temperature (operation) Standards/regulations Degree of pollution/overvoltage category
Connection data solid/stranded/AWG	Dimensions W / H / D
EMC note	

Technical data	
24 V DC	Approx. 14 mA
Approx. 350 Hz	Green LED, reverse polarity protection, surge protection
8.2 V DC $\pm 10\%$	≥ 2.1 mA (in conductive state)
≤ 1.2 mA (in blocking state)	6.3 mA ... 10 mA (in the event of a short-circuit)
0 mA ... 0.35 mA (in the event of a wire break)	Surge protection
$U_{VN} - U_{Res}$	50 mA
≤ 1.5 V (U_R)	Red LED, surge protection
50 mA	50 mA
≤ 1.5 V (U_R)	Surge protection
50 V DC	0.4 kV
Basic insulation	-25°C ... 50°C
IEC 60664, EN 50178	2 / 1
0.14 - 2.5 mm ² / 0.14 - 2.5 mm ² / 26 - 12	6.2 mm / 80 mm / 86 mm
Class A product, see page 583	

Description
Switching amplifier electronic terminal block, positive switching with screw connection with Push-in connection
Double-level terminal block, with preassembled resistors with screw connection

Ordering data		
Type	Order No.	Pcs./Pkt.
PLC-SC-EIK 1-SVN 24P/P	2982663	10
PLC-PT-EIK 1-SVN 24P/P	2900397	10

Accessories		
Type	Order No.	Pcs./Pkt.
UKK 5-2R/NAMUR	2941662	50

PLC series

Electronic reversing load relays for DC motors

The PLC-S...-ELR W 1/2-24DC electronic reversing load relays are used to switch mechanically commutated DC motors up to 24 V/2 A.

- Wear-free reversing
- Braking by controlling both inputs
- Short-circuit and surge and overload-proof output
- Integrated locking circuit and load wiring
- Screw or Push-in connection technology

Notes:
Type of insulating housing: Polyamide PBT non-reinforced, color: gray.
Marking systems and mounting material See Catalog 3
Separating plate PLC-ATP is to be used in the following cases: always at the start and end of a PLC terminal strip, for voltages greater than 250 V (L1, L2, L3) between the same terminal points of neighboring modules (potential bridging then takes place with FBST 8-PLC... or FBST 500...) and with safe isolation between neighboring modules.
For the protection of input and output, inductive loads must be dampened with an effective protection circuit.
PWM = Pulse Width Modulation
See the website for more information on connection cross sections with ferrules.



DC reversing load relay with overload and short-circuit-proof output

Application example for PLC-S...ELR W 1/2-24DC

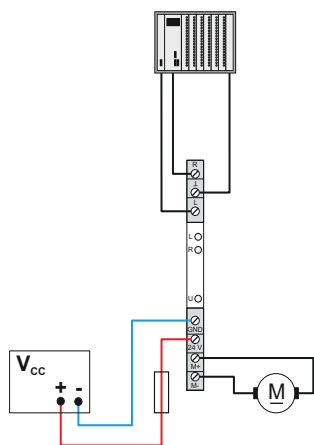

Status table

Input		Output	
Right	Left	M +	M -
0	0	High resistance	High resistance
1	0	+24 V	GND
0	1	GND	+24 V
1	1	GND	GND

Derating curve for PLC-S...ELR W 1/2-24DC

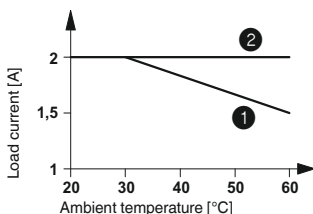

- 1 Aligned without spacing
- 2 Aligned with >20 mm spacing

Input data	Control voltage U_{ST} right/left Control input current I_{ST} right/left Input protection: PWM option Maximum clock frequency of the PWM at the control inputs
Output data	Pulse width repetition rate of the PWM Supply voltage range U_V Quiescent current Output protection Motor switching output Continuous current I_A max. Current limitation at short-circuits
General data	Rated insulation voltage Rated surge voltage / insulation Ambient temperature (operation) Standards/regulations Degree of pollution/overvoltage category
Mounting position	Mounting Connection data solid/stranded/AWG Dimensions EMC note

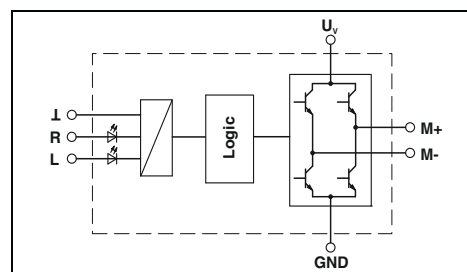

Technical data

24 V DC $\pm 20\%$ Approx. 3 mA Yellow LED, reverse polarity protection, surge protection
1,000 Hz
0% ... 100%
10 V DC ... 30 V DC 10 mA Green LED, reverse polarity protection, surge protection
2 A (see derating curve) 15 A (during braking)
50 V 0.5 kV / basic insulation -25°C ... 60°C IEC 60664, EN 50178 2 / II
Vertical (horizontal DIN rail) In rows with zero spacing 0.14 - 2.5 mm ² / 0.14 - 2.5 mm ² / 26 - 14 6.2 mm / 80 mm / 86 mm Class A product, see page 583

Ordering data

Type	Order No.	Pcs./Pkt.
PLC-SC-ELR W1/ 2-24DC	2980539	1
PLC-PT-ELR W1/ 2-24DC	1069556	1

Description
Electronic reversing load relays , for driving DC motors, with light indicator and protection circuit
with screw connection with Push-in connection

Relay modules

PLC-INTERFACE – Highly-compact relay modules

PLC-INTERFACE Pulse expansion modules

Solid-state relays for acquiring and extending short pulses.

- Pulse detection can be set from >0.1 ms or >2 ms
- Status display
- Delay times of 10 to 2550, can be set via DIP switches
- Bridging options
- Can be retriggered
- Screw and Push-in connection technology

Notes:
See the website for more information on connection cross sections with ferrules.



Solid-state relay module for the extension of input pulses, DC output max. 100 mA

ERIC

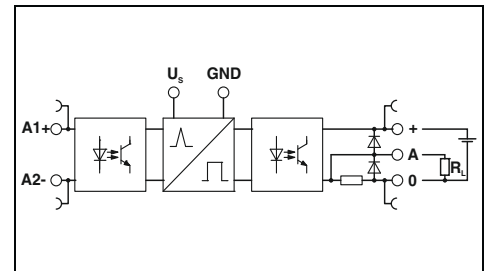

Technical data

Input data	
Rated control supply voltage U_s	24 V DC
Rated control supply voltage range with reference to U_s	0.8 ... 1.2
Rated control supply current I_s	
- Input low, output low	13 mA
- Input high, output high	19 mA
Rated actuating voltage U_c	24 V DC
Rated actuating current I_c	3 mA
Switching threshold "0" signal in reference to U_c	<0.4
Switching threshold "1" signal in reference to U_c	>0.8
Status indication	Yellow LED
Operating voltage display	Green LED
Input circuit	Reverse polarity protection, surge protection
Output data	
Output voltage range U_E	3 V DC ... 48 V DC
Limiting continuous current	100 mA
Voltage drop at maximum limiting continuous current	<1 V DC
Output circuit	3-conductor, ground-referenced
Output protection	Reverse polarity protection, surge protection, free running
General data	
Rated insulation voltage	50 V DC
Rated surge voltage	0.5 kV
Ambient temperature (operation)	-25°C ... 60°C
Standards/regulations	DIN EN 50178
Connection data solid/stranded/AWG	0.14 - 2.5 mm ² / 0.14 - 2.5 mm ² / 26 - 14
Dimensions	6.2 mm / 80 mm / 86 mm
EMC note	Class A product, see page 583

Ordering data

Description	Type	Order No.	Pcs./Pkt.
PLC INTERFACE, with screw connection			
PLC-INTERFACE, with Push-in connection			
	PLC-OSC-LPE-24DC/48DC/100	2903171	1
	PLC-OPT-LPE-24DC/48DC/100	2903173	1

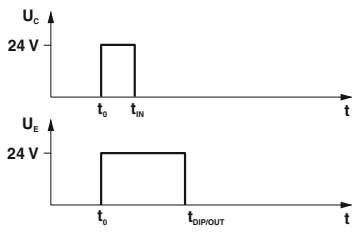

Input pulse $t_1 <$ set output pulse t_3
(no restart when triggered again)

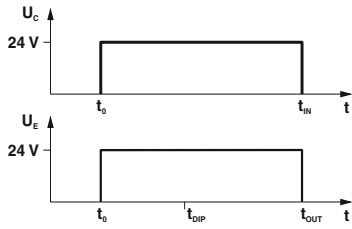

Input pulse $t_1 \geq$ set output pulse t_3 then:
input pulse $t_1 =$ output pulse t_2
(no restart when triggered again)

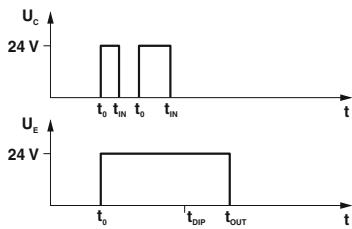

Input pulse $t_1 <$ set output pulse t_3
(restart when triggered again)

DIP							
S1	S2	S3	S4	S5	S6	S7	S8
10	-	-	-	-	-	-	-
-	20	-	-	-	-	-	-
-	-	40	-	-	-	-	-
-	-	-	80	-	-	-	-
-	-	-	-	160	-	-	-
-	-	-	-	-	320	-	-
-	-	-	-	-	-	640	-
-	-	-	-	-	-	-	1280

Relay modules

PLC-INTERFACE – Highly-compact relay modules

PLC accessories

The power terminal **PLC-ESK** helps in supplying the bridge potentials, the partition plate **PLC-ATP** helps in optical and safe disconnection of the adjacent PLC modules. The passive feed-through bridge **PLC-BP (A1-14)** is used instead of a relay and connects the A1 and 14 terminal points.



Feed-in terminal and partition plate



Feed-through bridge

		Ordering data			Ordering data		
Description	Color	Type	Order No.	Pcs./Pkt.	Type	Order No.	Pcs./Pkt.
Power terminal , for supply of up to four potentials, with the same shape as PLC standard series, max. 32 A/250 V AC	gray	PLC-ESK GY	2966508	5			
Separating plate , thickness 2 mm, required at the start and end of a PLC terminal strip. It also serves in visual separation of groups, safe isolation of different voltages of neighboring PLC interfaces as per DIN EN 50178/VDE0160, separation of neighboring bridges of different potentials and separation of PLC interfaces at voltages >250 V	black	PLC-ATP BK	2966841	25			
Screwdriver Blade: 0,6 x 3,5 x 100 mm, length: 181 mm		SZF 1-0,6X3,5	1204517	10			
Passive feed-through bridge , can be plugged in instead of relay or solid-state relay, bridges terminal points A1 and 14	black				PLC-BP A1-14	2980283	10

PLC accessories

The colored isolated FBST plug-in bridges are not required for the PLC interface to up to 70%. The 500 mm long “Endless bridges” **FBST 500-PLC** are especially effective. The 2-pos. single plug-in bridges **FBST 6** are especially suited for bridging a smaller number of PLC modules.



Plug-in bridge systems

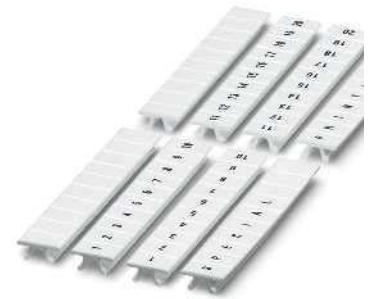

Marking material

		Ordering data			Ordering data		
Description	Color	Type	Order No.	Pcs./Pkt.	Type	Order No.	Pcs./Pkt.
Continuous plug-in bridge , 500 mm long, isolated, can be cut to length, for potential distribution Nominal current: 32 A	red	FBST 500-PLC RD	2966786	20			
	blue	FBST 500-PLC BU	2966692	20			
	gray	FBST 500-PLC GY	2966838	20			
Plug-in bridge , 2-pos., 6 mm long, for potential distribution Nominal current: 6 A	red	FBST 6-PLC RD	2966236	50			
	blue	FBST 6-PLC BU	2966812	50			
	gray	FBST 6-PLC GY	2966825	50			
Plug-in bridge , 2-pos., 8 mm long, for potential distribution with a partition plate Nominal current: 6 A	gray	FBST 8-PLC GY	2967688	50			
Plug-in bridge , 2-pos., 14 mm long, insulated, for potential distribution Nominal current: 10 A	black	FBST 14-PLC BK	2967691	50			
Zack marker strip, printed horizontally , 10-section, with consecutive numbers, e.g., 1-10, 11-20, etc. up to 91-100					ZB 6,LGS:FORTL.ZAHLEN	1051016	10

Adapters for PLC-INTERFACE

PLC-V8/... are the VARIOFACE adapters which connect the narrow PLC-INTERFACE modules to the VARIOFACE system cabling:

Notes:
Cross list with matching PLC-INTERFACE modules, see page 534



VARIOFACE adapter for 6.2 mm PLC-INTERFACE



VARIOFACE adapter for 14 mm PLC-INTERFACE



		Technical data	Technical data
Maximum permissible operating voltage		30 V DC	30 V DC
Maximum permissible current (per branch)		1 A (per signal path)	1 A (per signal path)
Maximum total current (voltage supply)		3 A	3 A
Ambient temperature (operation)		-40°C ... 70°C	-40°C ... 70°C
Standards/regulations		IEC 60664, DIN EN 50178	IEC 60664, DIN EN 50178
Connection method	Supply	Screw connection	Screw connection
	Controller level	IDC/FLK pin strip	IDC/FLK pin strip
Connection data solid/stranded/AWG		0.2 ... 4 mm ² / 0.2 ... 2.5 mm ² / 24 - 12	0.2 ... 4 mm ² / 0.2 ... 2.5 mm ² / 24 - 12
Dimensions	H / D	39 mm / 56 mm	39 mm / 56 mm

			Ordering data			Ordering data		
Description	No. of pos.	Module width W	Type	Order No.	Pcs./Pkt.	Type	Order No.	Pcs./Pkt.
V8 adapter , for 8 PLC-INTERFACES (6.2 mm), with IDC/FLK pin strip, for PLC system cabling, positive switching								
Output	14	50 mm	PLC-V8/FLK14/OUT	2295554	1			
Input	14	50 mm	PLC-V8/FLK14/IN	2296553	1			
V8 adapter , for 8 PLC-INTERFACES (6.2 mm), with IDC/FLK pin strip, for PLC system cabling, negative switching								
Output	14	50 mm	PLC-V8/FLK14/OUT/M	2304102	1			
Input	14	50 mm	PLC-V8/FLK14/IN/M	2304115	1			
V8 output adapter , for 8 PLC-INTERFACES (6.2 mm), with D-SUB connection								
Pin strip	15	50 mm	PLC-V8/D15S/OUT	2296058	1			
Socket strip	15	50 mm	PLC-V8/D15B/OUT	2296061	1			
V8 input adapter , for 8 PLC-INTERFACES (6.2 mm), with D-SUB connection								
Pin strip	15	50 mm	PLC-V8/D15S/IN	2296074	1			
Socket strip	15	50 mm	PLC-V8/D15B/IN	2296087	1			
V8 adapter , for 8 PLC-INTERFACES (14 mm), with IDC/FLK pin strip, for PLC system cabling, positive switching	14	112.5 mm				PLC-V8L/FLK14/OUT	2299660	1
V8 adapter , for 8 PLC-INTERFACES (14 mm), with IDC/FLK pin strip, for PLC system cabling, negative switching	14	112.5 mm				PLC-V8L/FLK14/OUT/M	2304306	1

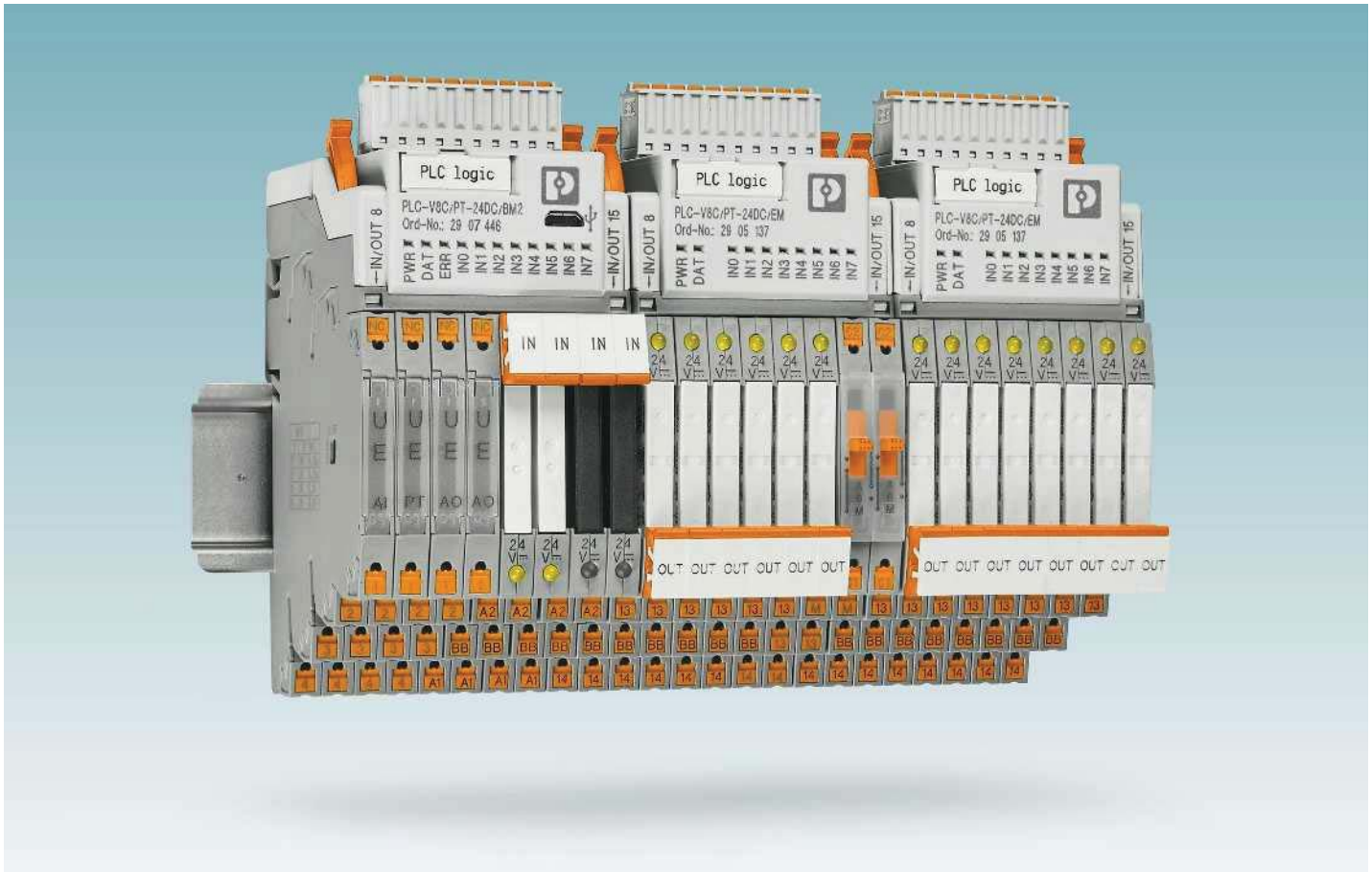

Extremely compact control

The PLC logic programmable logic relay system is the extremely compact way to carry out small automation tasks easily and flexibly. It consists of the PLC-V8C logic modules, the PLC-INTERFACE relay system, and the LOGIC+ software. The logic modules are simply plugged into a row of eight PLC-INTERFACE terminal blocks and combine the logic and interface level in one unit. Depending on the switching requirements, plug-in electromechanical and solid-state relays can be combined in order to flexibly switch and control the I/O signals.

PLC logic processes digital and analog input signals as well as logic functions and timer modules – and replaces conventional switching and control devices. Up to 16 I/O signals can be processed using the stand-alone logic modules – that's with a design width of just 50 mm. If more I/O signals are required, a maximum of 48 I/O signals can be linked using the basic and extension modules.

Switching and controlling with plug-in relays

- PLC logic brings together the standard combination of logic module and separate plug-in relay and eliminates the wiring effort and additional switching elements
- Convenient connections with screw or Push-in connection technology, which also accommodate return conductors, remove the need for separate potential terminal blocks
- Each channel can be freely configured as an input or output and with relay or analog modules

Intuitive programming

Programming is quick and easy with the intuitive LOGIC+ programming software. Ladder (LD) and function block diagrams (FBD) can be created by selecting the relevant functions and their connection using drag & drop. The graphical representation of PLC logic in the hardware editor supports intuitive operation. The programs created can be simulated offline on the PC and tested online during operation. Basic functions, such as AND, OR, NOT, etc. are complemented by special functions, such as counters, seven-day timers, timer modules, and mathematical functions, to name a few.



Logic modules with plug-in relays

PLC logic combines a logic module and plug-in relay and eliminates the wiring effort and additional switching elements. Each relay channel can be flexibly equipped with an electromechanical or a solid-state relay. PLC logic processes 16 I/O signals with just one logic module and boasts an extremely compact design width of just 50 mm.



Intuitive programming with LOGIC+

- Function block diagram or ladder diagram
- Numerous integrated function blocks
- Specific function blocks are available to download
- Hardware view in the program
- Can be downloaded free of charge

i Your web code: #0139



Visualization using a touch panel

For jobs requiring control, operation, and monitoring, the BTP 2000 series HMIs go perfectly with PLC logic. Basic touch panels can be used to visualize all the logic module process data. Three different display sizes enable clear representation, from simple alphanumeric images to graphics-intensive images with object animation.

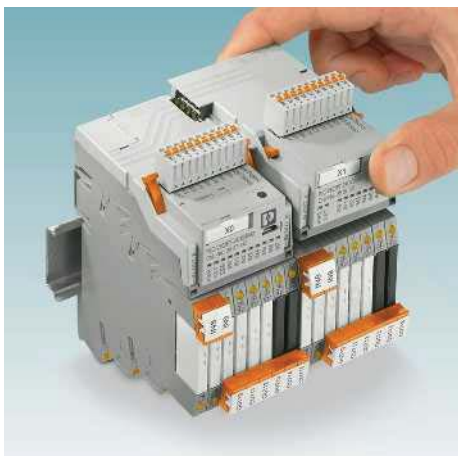

Easily connect extension modules

The basic module and the extension module are connected via integrated connectors – no tools required. A maximum of two extension modules can be connected to a basic module. This means that PLC logic can work with up to 48 I/Os.



Control and monitor via Bluetooth adapter

Together with the PLC logic app, the Bluetooth adapter is available for wireless access to process data between the logic module and the mobile end device, and can be used for operation and monitoring purposes.

The Bluetooth connection enables efficient monitoring of multiple logic modules, with just one visualization device.

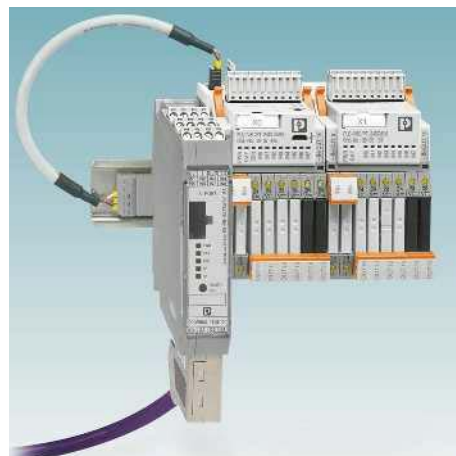

Integration into common bus systems

PLC logic is integrated into various networks via optional adaptable fieldbus gateways. This enables bidirectional communication with a higher-level controller for remote control as well as diagnostics and visualization.

Gateways are available for transmitting data via PROFIBUS DP, Modbus/TCP, CANopen®, PROFINET, and EtherNet/IP™.

Logic modules

PLC-V8C devices are the plug-in logic modules which form the PLC logic relay system in conjunction with the narrow 6.2 mm PLC-INTERFACE terminal blocks. Eight freely-selectable PLC-INTERFACE terminal blocks must be separately ordered for each logic module. You can find an overview of matching PLC-INTERFACE terminal blocks on page 436.

All logic modules feature these properties:

- 8 integrated digital inputs (two of which can be configured as analog inputs)
- A further 8 channels can be configured with matching PLC-INTERFACE terminal blocks as inputs or outputs
- Programming with LOGIC+ software

PLC-V8C.../SAM2

- Stand-alone logic module with 16 I/Os, not extendable
- Connection to PC via micro USB socket
- Integrated realtime clock (RTC)
- Accommodates external IFS-CONFSTICK memory block
- Relay and analog modules can be used

PLC-V8C.../BM2

- Basic logic module with 16 I/Os, can be extended with a maximum of two extension modules (PLC-V8C.../EM) to 48 I/Os
- Connection to PC via micro USB socket
- Integrated realtime clock (RTC)
- Accommodates external IFS-CONFSTICK memory block
- Optional connection to IFS gateways
- Relay and analog modules can be used

PLC-V8C.../EM

- Extension logic module with 16 I/Os, for extending the basic module
- Relay modules can be used



Stand-alone module

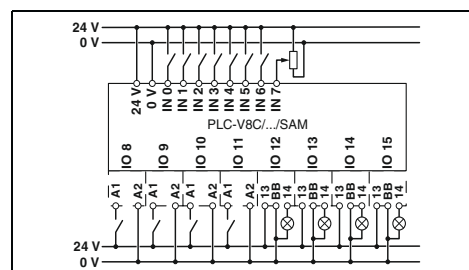

Technical data

Supply	
Supply voltage	24 V DC
Supply voltage range	19.2 V DC ... 26.4 V DC
Maximum input current at U_N	160 mA
Input data (digital)	
Number of inputs	8 (2 configurable as analog)
Input voltage	24 V DC
Description of the input	EN 61131-2, type 3
Input current 0-signal	<1 mA
Input current 1-signal	Typically 2.5 mA
Input data (analog)	
Number of inputs	2 (IN6 and IN7 are configurable as analog)
Input voltage range	0 V ... 10 V
Input resistance	>3.5 kΩ
Input data (PLC-INTERFACE)	
Number of inputs	≤8
Output data (for controlling PLC-INTERFACE)	
Number of outputs	≤8
Nominal voltage	24 V DC
Nominal current	9 mA
Realtime clock (basic module only)	
Buffer time (capacitor)	96 h (capacitor)
Realtime clock accuracy	±2 s/d
General data	
Ambient temperature (operation)	-20°C ... 50°C
Ambient temperature (storage/transport)	-20°C ... 70°C
Permissible humidity (operation)	95%
Air clearances and creepage distances between the power circuits	DIN EN 50178
Rated insulation voltage	50 V
Rated surge voltage	0.8 kV
Insulation	Basic insulation
Mounting type	Can be plugged onto 8 x PLC-INTERFACE terminal blocks
Degree of protection	IP20
Screw connection rigid / flexible / AWG	0.14 - 1.5 mm ² / 0.14 - 1.5 mm ² / 26 - 16
Push-in connection rigid / flexible / AWG	0.14 - 1.5 mm ² / 0.14 - 1.5 mm ² / 26 - 16

Ordering data

Description	Type	Order No.	Pcs./Pkt.
PLC-V8C plug-in logic modules with Push-in connection	PLC-V8C/PT-24DC/SAM2	2907443	1



**Basic module
(can be extended)**

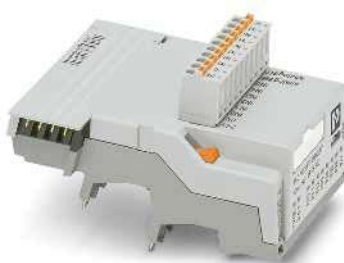

Extension module

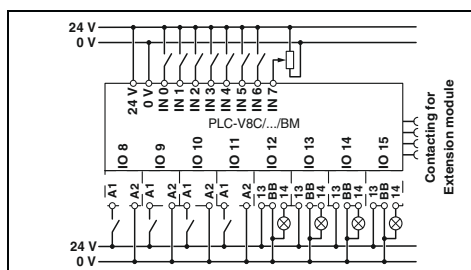

Technical data

24 V DC
19.2 V DC ... 26.4 V DC
160 mA

8 (2 configurable as analog)
24 V DC
EN 61131-2, type 3
<1 mA
Typically 2.5 mA

2 (IN6 and IN7 are configurable as analog)

0 V ... 10 V
>3.5 kΩ

≤8

≤8
24 V DC
9 mA

96 h (capacitor)
±2 s/d

-20°C ... 50°C
-20°C ... 70°C
95%
DIN EN 50178

50 V
0.8 kV
Basic insulation
Can be plugged onto 8 x PLC-INTERFACE terminal blocks

IP20
0.14 - 1.5 mm² / 0.14 - 1.5 mm² / 26 - 16
0.14 - 1.5 mm² / 0.14 - 1.5 mm² / 26 - 16

Ordering data

Type	Order No.	Pcs./Pkt.
PLC-V8C/PT-24DC/BM2	2907446	1

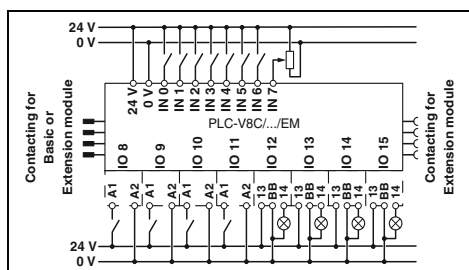

Technical data

24 V DC
19.2 V DC ... 26.4 V DC
65 mA

8 (2 configurable as analog)
24 V DC
EN 61131-2, type 3
<1 mA
Typically 2.5 mA

2 (IN6 and IN7 are configurable as analog)

0 V ... 10 V
>3.5 kΩ

≤8

≤8
24 V DC
9 mA

-
-

-20°C ... 45°C
-20°C ... 70°C
95%
DIN EN 50178

50 V
0.8 kV
Basic insulation
Can be plugged onto 8 x PLC-INTERFACE terminal blocks

IP20
0.14 - 1.5 mm² / 0.14 - 1.5 mm² / 26 - 16
0.14 - 1.5 mm² / 0.14 - 1.5 mm² / 26 - 16

Ordering data

Type	Order No.	Pcs./Pkt.
PLC-V8C/PT-24DC/EM	2905137	1

Relay modules

PLC logic – Programmable logic relay system

Analog modules

Together with the PLC logic modules, the analog modules enable analog standard signals to be processed.

The analog modules are connected to PLC logic stand-alone modules or basic modules.

- Status indicator for supply voltage and diagnostics
- Standard configuration: 4 to 20 mA or Pt 100

Analog input

- Available standard signals: 0 to 20 mA, 4 to 20 mA, 0 to 10 V or 2 to 10 V (configurable via DIP switch)

Temperature transducer

- 2-conductor Pt 100 or Pt 1000 (configurable via DIP switch)
- Temperature measuring range: -50 to 200°C

Analog output

- Available standard signals: 0 to 20 mA, 4 to 20 mA, 0 to 10 V or 2 to 10 V (configurable via DIP switch)

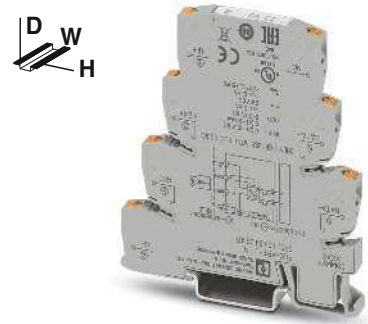

Analog input

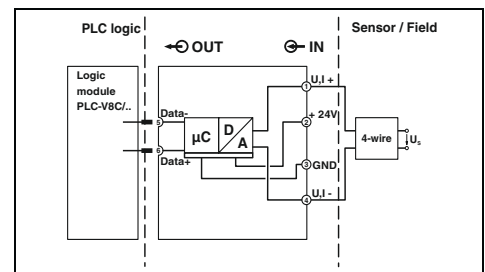

Technical data

Supply		
Rated control supply voltage U_S	24 V DC	
Rated control supply voltage range with reference to U_S	0.8 ... 1.1	
Rated control supply current I_S	13 mA	
Operating voltage display	Green LED	
Input signal		
Input signal	Voltage input	
	Current input	
	0 V ... 10 V	0 mA ... 20 mA
	2 V ... 10 V	4 mA ... 20 mA
	>120 kΩ	~ 40 Ω
Output data		
Output signal	-	
Maximum output signal	-	
Load R_B	-	
Ripple	-	
General data		
Ambient temperature (operation)	-20°C ... 50°C	
Ambient temperature (storage/transport)	-20°C ... 70°C	
Air clearances and creepage distances between the power circuits	DIN EN 50178	
Rated insulation voltage	50 V	
Rated surge voltage	0.5 kV	
Insulation	Basic insulation	
Mounting type	In rows with zero spacing	
Degree of protection	IP20	
Screw connection rigid / flexible / AWG	0.14 - 2.5 mm ² / 0.14 - 2.5 mm ² / 26 - 14	
Push-in connection rigid / flexible / AWG	0.14 - 2.5 mm ² / 0.14 - 2.5 mm ² / 26 - 14	

Ordering data

Description	Type	Order No.	Pcs./Pkt.
with Push-in connection	PLC-APT-UI-IN	2906917	1
with Push-in connection			
with Push-in connection			



Temperature transducer



Analog output

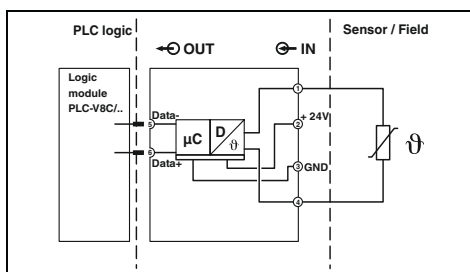

Technical data

24 V DC
0.8 ... 1.1
14 mA
Green LED
Temperature range
-50°C ... 200°C

-20°C ... 50°C
-20°C ... 70°C
DIN EN 50178

50 V
0.5 kV
Basic insulation
In rows with zero spacing
IP20
0.14 - 2.5 mm² / 0.14 - 2.5 mm² / 26 - 14
0.14 - 2.5 mm² / 0.14 - 2.5 mm² / 26 - 14

Ordering data

Type	Order No.	Pcs./Pkt.
PLC-APT-PT100-IN	2906919	1

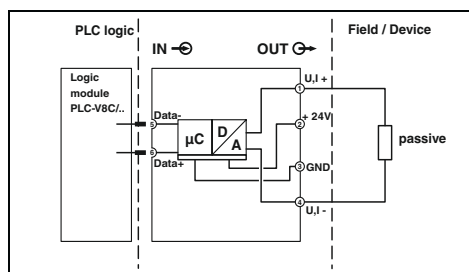

Technical data

24 V DC
0.8 ... 1.1
≤28 mA
Green LED

-20°C ... 50°C
-20°C ... 70°C
DIN EN 50178

50 V
0.5 kV
Basic insulation
In rows with zero spacing
IP20
0.14 - 2.5 mm² / 0.14 - 2.5 mm² / 26 - 14
0.14 - 2.5 mm² / 0.14 - 2.5 mm² / 26 - 14

Ordering data

Type	Order No.	Pcs./Pkt.
PLC-APT-UI-OUT	2906921	1

Relay modules

PLC logic – Programmable logic relay system

Accessories

Programming cable and memory block

- The programming cable (MICRO USB B to USB A) is used to connect PLC logic to a PC, length: 2 m
- PLC logic programs are saved by the memory block or can be easily copied to other devices



Cable for programming



Memory block

General data		Technical data			Technical data		
EMC note					Class A product, see page 583		
Description		Ordering data			Ordering data		
	Color	Type	Order No.	Pcs./Pkt.	Type	Order No.	Pcs./Pkt.
Programming cable		CAB-USB A/MICRO USB B/2,0M	2701626	1			
Multi-functional memory block for the Interface system					IFS-CONFSTICK	2986122	1
- Flat design							

Accessories

PLC logic starter kit

The PLC logic starter kit with 8 inputs and 8 outputs contains all the components needed to get started quickly and easily with PLC logic with Push-in connection technology.

- PLC-V8C-PT/24DC/SAM2 plug-in logic module
- PLC-RPT-24DC/1/ACT eight relay output terminal blocks
- Micro USB programming cable



Starter kit with stand-alone module

Description		Ordering data		
	Color	Type	Order No.	Pcs./Pkt.
PLC logic starter kit 3 , consisting of: plug-in stand-alone logic module, eight relay output terminal blocks with Push-in connection (250 V AC/DC, max. 6 A), and micro USB programming cable		PLC-LOGIC-STARTERKIT3	2909916	1

Accessories

IFS gateways and Bluetooth adapter

- The gateways are connected to the PLC-V8C.../BM PLC logic basic module via the DIN rail connector and the connecting cable
 - The Bluetooth adapter is connected to the logic module via the memory connection
- Current values are monitored and controlled via the PLC logic app.

INTERFACE system bus master terminal (IB IL IFS-MA-PAC, 2692720) for connecting PLC logic to a Inline controller; see Catalog 6, Automation

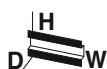

IFS gateway



Bluetooth adapter



General data
EMC note

Class A product, see page 583

Description	Color
IFS gateway for PROFIBUS DP	gray
Modbus/TCP	gray
CANopen®	gray
PROFINET	gray
EtherNet/IP™	gray
Programming adapter for configuring modules with S-PORT interface	
Cable length: 3 m	
DIN rail connector	green
Connecting cable for connecting PLC logic with the ME 22,5 TBUS DIN rail connector, cable length: 0.3 m	
Bluetooth programming adapter , with USB and S-PORT interface	

Technical data		
Ordering data		
Type	Order No.	Pcs./Pkt.
EM-PB-GATEWAY-IFS	2297620	1
EM-MODBUS-GATEWAY-IFS	2901528	1
EM-CAN-GATEWAY-IFS	2901504	1
EM-PNET-GATEWAY-IFS	2904472	1
EM-ETH-GATEWAY-IFS	2901988	1
IFS-USB-DATACABLE	2320500	1
ME 22,5 TBUS 1,5/ 5-ST-3,81 GN	2707437	50
PLC-V8C/CAB/TBUS/0,3M	2905263	1

Technical data		
Ordering data		
Type	Order No.	Pcs./Pkt.
IFS-BT-PROG-ADAPTER	2905872	1

Selection table for PLC-INTERFACE

Relay output	Push-in connection		Screw connection	
	Type	Order No.:	Type	Order No.:
1 changeover contact, output data: 6 A, 250 V AC/DC	PLC-RPT-24DC/21	2900299	PLC-RSC-24DC/21	2966171
1 changeover contact, output data: 50 mA, 36 V DC, gold contact	PLC-RPT-24DC/21AU	2900306	PLC-RSC-24DC/21AU	2966265
1 N/O contact, output data: 6 A, 250 V AC/DC, actuator type	PLC-RPT-24DC/1/ACT	2900312	PLC-RSC-24DC/1/ACT	2966210
1 N/O contact with switch, output data: 6 A, 250 V AC/DC	PLC-RPT-24UC/1/S/H	2900328	PLC-RSC-24UC/1/S/H	2982236
Solid-state relay output				
Output data: 100 mA, 3 V DC - 48 V DC	PLC-OPT-24DC/48DC/100	2900352	PLC-OSC-24DC/48DC/100	2966728
Output data: 3 A, 3 V DC - 33 V DC	PLC-OPT-24DC/24DC/2	2900364	PLC-OSC-24DC/24DC/2	2966634
Output data: 750 mA, 24 V AC - 253 V AC	PLC-OPT-24DC/230AC/1	2900369	PLC-OSC-24DC/230AC/1	2967840
Output data: 3 A, 3 V DC - 33 V DC, actuator type	PLC-OPT-24DC/24DC/2/ACT	2900376	PLC-OSC-24DC/24DC/2/ACT	2966676
Output data: 750 mA, 24 V AC - 253 V AC, actuator type			PLC-OSC-24DC/230AC/1/ACT	2967947
Output data: 1 A, 12 V DC - 300 V DC	PLC-OPT-24DC/300DC/1	2900383	PLC-OSC-24DC/300DC/1	2980678
Output data: 500 mA, 3 V DC - 48 V DC, electronic changeover contact	PLC-OPT-24DC/48DC/500/W	2900378	PLC-OSC-24DC/48DC/500/W	2980636
Output data, TTL, 50 mA, 5 V DC	PLC-OPT-24DC/TTL	2900363	PLC-OSC-24DC/TTL	2982728
Analog output				
Output signal: 0 V ... 10 V, 2 V ... 10 V, 0 mA ... 20 mA, 2 mA ... 20 mA	PLC-APT-UI-OUT	2906921	PLC-ASC-UI-OUT	2906920
Relay input				
Input voltage: 24 V DC	PLC-RPT-24DC/1AU/SEN	2900313	PLC-RSC-24DC/1AU/SEN	2966317
Input voltage: 120 V AC/DC	PLC-RPT-120UC/1AU/SEN	2900314	PLC-RSC-120UC/1AU/SEN	2966320
Input voltage: 230 V AC/DC	PLC-RPT-230UC/1AU/SEN	2900315	PLC-RSC-230UC/1AU/SEN	2966333
Input voltage: 5 V DC (basic terminal block without relay)			PLC-BSC- 5DC/ 1/SEN	2980267
Relay for 5 V DC basic terminal block			REL-MR-4,5DC/21AU	2961370
Solid-state relay input				
Input voltage: 24 V DC	PLC-OPT-24DC/V8C/SEN	2908172	PLC-OSC-24DC/V8C/SEN	2908173
Input voltage: 120 V AC/DC	PLC-OPT-120UC/V8C/SEN	2908174	PLC-OSC-120UC/V8C/SEN	2908175
Input voltage: 230 V AC/DC	PLC-OPT-230UC/V8C/SEN	2908176	PLC-OSC-230UC/V8C/SEN	2908177
Analog input				
Input signal: 0 V ... 10 V, 2 V ... 10 V, 0 mA ... 20 mA, 2 mA ... 20 mA	PLC-APT-UI-IN	2906917	PLC-ASC-UI-IN	2906916
Input signal: Pt 100 or Pt 1000 sensor	PLC-APT-PT100-IN	2906919	PLC-ASC-PT100-IN	2906918
Dummy or reserve				
Basic terminal blocks: output	PLC-BPT-24DC/21	2900445	PLC-BSC-24DC/21	2966016
Basic terminal blocks: input	PLC-BPT-24DC/1/SEN	2900262	PLC-BSC-24DC/1/SEN	2966061

LOGIC+ programming software

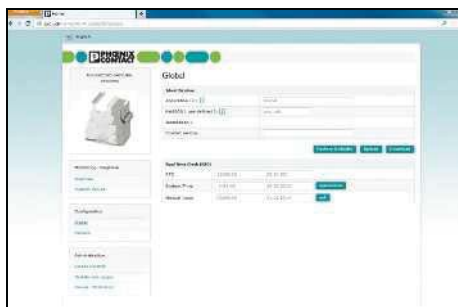

Integrated web server

PLC logic basic settings are easily configured via the integrated web server. The LOGIC+ software does not need to be installed in order to do so.

- Time and date
- Password and access control
- Firmware update
- Status indicators for inputs and outputs
- General device information

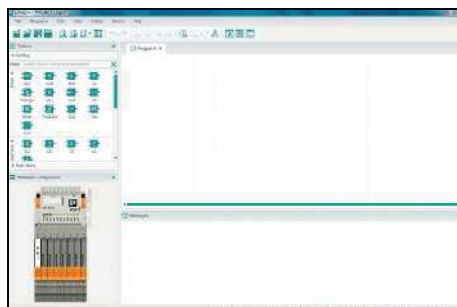

Logic+ user interface

- Clear separation in program editor, toolbox, hardware view, and signaling window
- All elements can be easily placed using drag & drop
- Notes and errors are highlighted in color in the program editor



Hardware configurator

- Each channel can be configured as an input or output and with relay or analog modules
- Clear assignment of the inputs and outputs, thanks to the graphical representation of the hardware connections

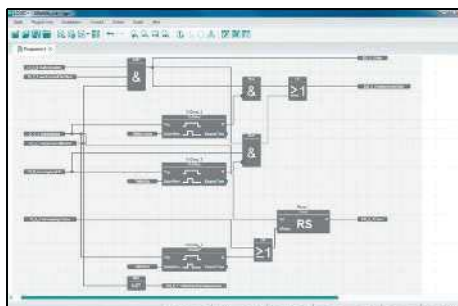

Function blocks

- Basic functions: AND, OR, NOT, XOR
- Mathematical functions: add, divide, multiply, subtract, generate absolute value
- Positive and negative edge detection
- RS and SR flip-flops
- Switch-on and switch-off delay, pulse encoder, pulse stretching, weekly clock timer
- Up and down counter
- Analog and digital comparators
- Special functions, for example, roller shutter control or pulse width modulation are available to download

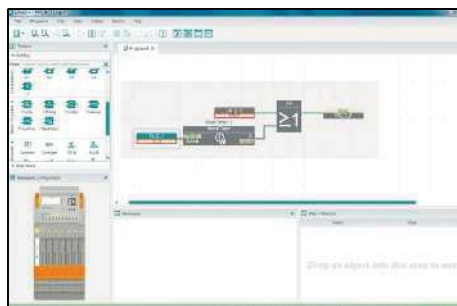

Simulation and online values

- Offline simulation:
 - Simulation of the created program directly in LOGIC+
 - Virtualization of the values in the program editor, hardware view, and in the observation window
- Online values:
 - Representation of the program running on the hardware in LOGIC+ with online values
 - Overwriting values from LOGIC+



PLC logic app

- Once the app is installed on your smartphone or tablet, it can be used to make parameter adjustments to the logic modules. The visualization view is created via the editor of the web server integrated in the logic modules. The app can be used for operation and monitoring, as it can access all program variables.
- Inputs and outputs (digital, analog)
 - Flags
 - Numerical values
 - Time values

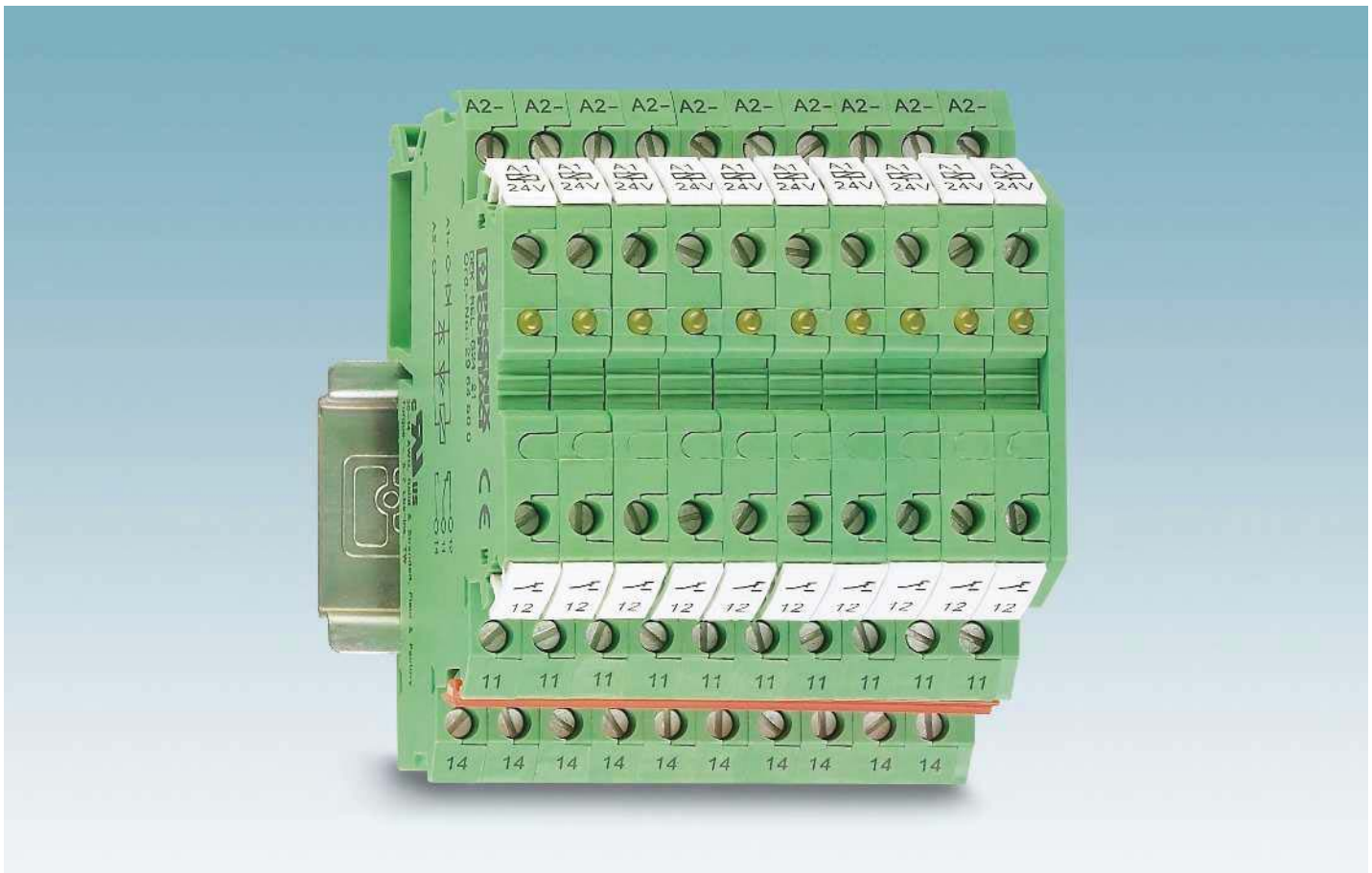

The Phoenix Contact interface terminal blocks DEK provide complete interface functions in modular terminal block housing that is just 6.2 mm wide. In conjunction with standard terminal block accessories, these high capacity interfaces have not only the design but also the high level of user convenience of modular terminal blocks.

The main common feature of all Phoenix Contact interface terminal blocks is their width of just 6.2 mm. This saves 60% space in the control cabinet in comparison to conventional 15 mm wide coupling relays from modular systems.

The DEK range offers the best solution for all industrial voltages both for signal input and output.

High switching capacities are a matter of course for the relay terminal block DEK-REL... and the solid-state relay terminal block DEK-OV...

The wear-free DEK-OV... power-level terminal is used in applications with high switching rates where electromechanical relays quickly exhaust their service life.

Integrated LEDs clearly indicate the switching status of the electronic terminal blocks and provide an excellent overview of the coupling level and the system.

Colored insertion bridges EB-DIK for the supply and ground signals make it possible to design the circuit simply and effectively.

Integrated protective circuits such as free-wheeling diodes, polarity reversal protection diodes and surge protection elements protect the coupling modules and ensure optimum availability of the system.

Relay terminal blocks DEK-REL-...

The Phoenix relay terminal block with PDT contact offers the following advantages:

- Width of only 6.2 mm
- High switching capacity of 250 V AC / 6 A
- Less storage, because changeover, N/O or N/C contacts can be wired
- Little wiring expense due to the use of EB-DIK insertion bridges
- IP67 protected relay housing
- Cadmium-free relay contacts
- 4 kV electrical isolation of input and output
- Safe isolation in accordance with DIN EN 50178 (VDE 0160)
- Light indicator for signaling the switching status

Notes:
Type of housing: Polyamide PA non-reinforced, color: green.
Marking systems and mounting material See Catalog 3
For the protection of relay coils and contacts, inductive loads must be dampened with an efficient protection circuit.
Other insertion bridges EB...DIK... refer to page 445



For medium to high powers
1 changeover contact (21)

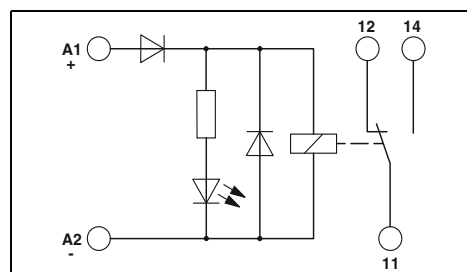

Technical data

Input data		①
Permissible range (with reference to U_N)		0.8 - 1.1
Typical input current at U_N	[mA]	9
Response/release time at U_N	[ms]	8 / 5
Input protection:		Yellow LED, reverse polarity protection, free-wheeling diode
Output data		
Contact type		1 PDT
Contact material		AgSnO
Max. switching voltage		250 V AC/DC
Minimum switching voltage		12 V AC/DC
Limiting continuous current		6 A
Maximum switch-on current		6 A
Minimum switching current		10 mA
Maximum interrupting rating, ohmic load		
	24 V DC	140 W
	48 V DC	20 W
	60 V DC	18 W
	110 V DC	23 W
	220 V DC	40 W
	250 V AC	1,500 VA
General data		
Test voltage (winding/contact)		4 kV AC (50 Hz, 1 min.)
Ambient temperature (operation)		-20°C ... 50°C
Mechanical service life		Approx. 10 ⁷ cycles
Standards/regulations		IEC 60664, EN 50178
Connection data solid/stranded/AWG		0.2 - 2.5 mm ² / 0.2 - 2.5 mm ² / 24 - 14
Dimensions		W / H / D 6.2 mm / 80 mm / 56 mm
EMC note		Class A product, see page 583

Ordering data

Description	Input voltage U_N	Type	Order No.	Pcs./Pkt.
Relay terminal block with power relay	① 24 V DC	DEK-REL-G24/21	2964500	10

Accessories

Accessories	Order No.	Pcs./Pkt.
D-DEK 1,5 GN	2716949	10
EB 80- DIK BU	26 A 2715940	1
EB 80- DIK RD	26 A 2715953	1
EB 80- DIK WH	26 A 2715788	1

Relay modules

Relay modules in terminal block design – DEK series

Input interface DEK-REL-24/1/SEN and output interface DEK-REL-24/1/AKT

In addition to the familiar advantages of the electronic terminal blocks DEK-REL... such as

- 2-layer contact with hard gold-plating for universal applications from 1 mA to 5 A continuous current
- 2 kV_{rms} electrical isolation of input and output
- Integrated input circuit

With this terminal block, all connections for a sensor or actuator are provided over a width of just 6.2 mm!

This means that 16 outputs take up a total constructional width of just 105.4 mm (including the power terminal block).

Advantages:

- Lower costs as the N terminal block is no longer required
- Wiring is reduced to a minimum
- Up to 73% more space

Notes:
Type of housing: Polyamide PA non-reinforced, color: green.
Marking systems and mounting material See Catalog 3
For the protection of relay coils and contacts, inductive loads must be damped with an efficient protection circuit.
Other insertion bridges EB...DIK... refer to page 445

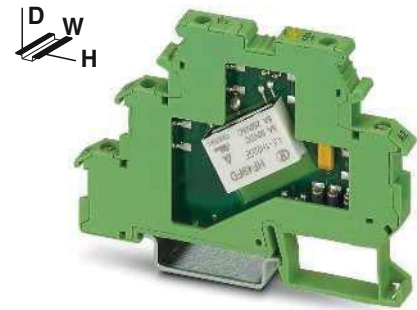

For low to medium powers
1 N/O contact (1)

ERC

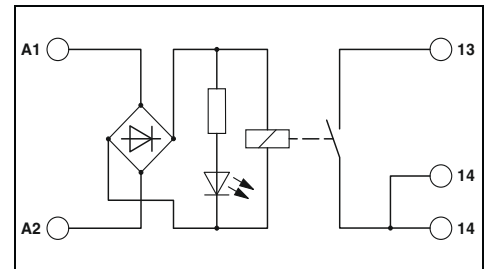

Technical data

Input data	①	②
Permissible range (with reference to U _N)	0.9 - 1.1	0.8 - 1.1
Typical input current at U _N	23	6.5
Response/release time at U _N	8 / 15	5 / 15
Input protection:	Yellow LED, bridge rectifier	
Output data		
Contact type	1 N/O contact (double contact)	
Contact material	AgNi, hard gold-plated	
Max. switching voltage	250 V AC / 125 V DC	
Minimum switching voltage	0.1 V	
Limiting continuous current	3 A (5 A up to 35°C at 24 V DC)	
Maximum switch-on current	5 A	
Minimum switching current	1 mA	
Maximum interrupting rating, ohmic load	24 V DC	72 W
	48 V DC	60 W
	60 V DC	50 W
	110 V DC	50 W
	250 V AC	750 VA
General data		
Test voltage (winding/contact)	2 kV AC (50 Hz, 1 min.)	
Ambient temperature (operation)	-20°C ... 50°C	
Mechanical service life	Approx. 2x 10 ⁷ cycles	
Standards/regulations	IEC 60664, EN 50178	
Connection data solid/stranded/AWG	0.2 - 2.5 mm ² / 0.2 - 2.5 mm ² / 24 - 14	
Dimensions	W / H / D 6.2 mm / 80 mm / 56 mm	
EMC note	Class A product, see page 583	

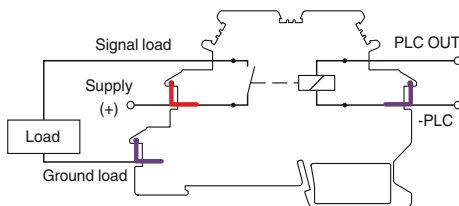

Pin configuration, DEK-REL-...AKT

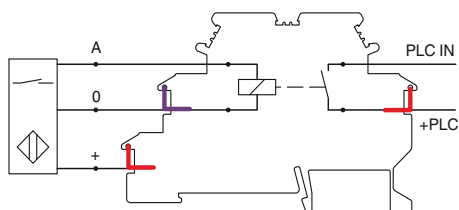

Pin configuration DEK-REL-...SEN

Description	Input voltage U _N
Relay terminal block with miniature relay	
	① 5 V AC/DC
	② 24 V AC/DC

Terminal block, with three through contacts, for mounting on NS 35...
For busbar feeding

Insertion bridge, for middle and lower levels	No. of pos.	Color
	80	blue
	80	red
	80	white

Ordering data		
Type	Order No.	Pcs./Pkt.
DEK-REL- 5//1	2941183	10
DEK-REL- 24//1	2940171	10

Accessories		
Type	Order No.	Pcs./Pkt.
D-DEK 1,5 GN	2716949	10
EB 80- DIK BU	26 A 2715940	1
EB 80- DIK RD	26 A 2715953	1
EB 80- DIK WH	26 A 2715788	1

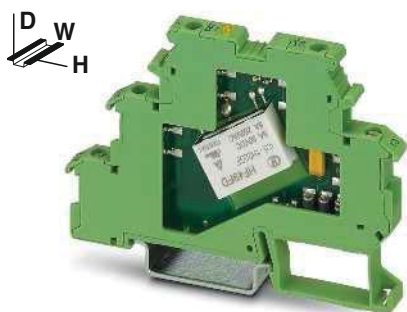

For low to medium powers
1 N/O contact (1)

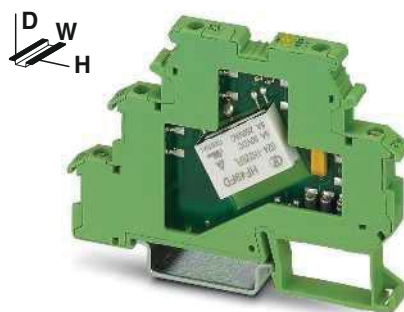

For low to medium powers
1 N/O contact (1)

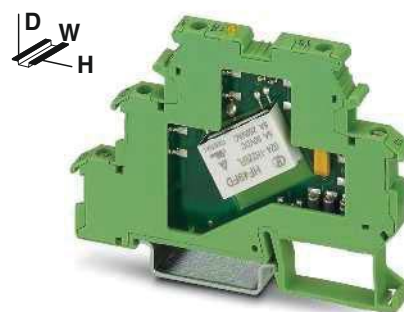

For low to medium powers
1 N/O contact (1)

ERC

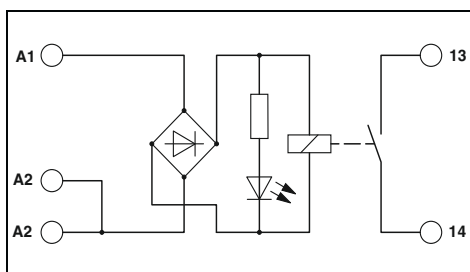

Technical data

①	②
0.9 - 1.1	0.8 - 1.1
23	6.5
8 / 15	5 / 15

Yellow LED, bridge rectifier

1 N/O contact (double contact)
AgNi, hard gold-plated
250 V AC / 125 V DC
0.1 V
3 A (5 A up to 35°C at 24 V DC)
5 A
1 mA

72 W
60 W
50 W
50 W
750 VA

2 kV AC (50 Hz, 1 min.)
-20°C ... 50°C
Approx. 2x 10⁷ cycles
IEC 60664, EN 50178
0.2 - 2.5 mm² / 0.2 - 2.5 mm² / 24 - 14
6.2 mm / 80 mm / 56 mm
Class A product, see page 583

Ordering data

Type	Order No.	Pcs./Pkt.
DEK-REL- 5/O/1	2941170	10
DEK-REL- 24/O/1	2941154	10

Accessories

Accessories	Order No.	Pcs./Pkt.
D-DEK 1,5 GN	2716949	10
EB 80- DIK BU	26 A 2715940	1
EB 80- DIK RD	26 A 2715953	1
EB 80- DIK WH	26 A 2715788	1

us ERC

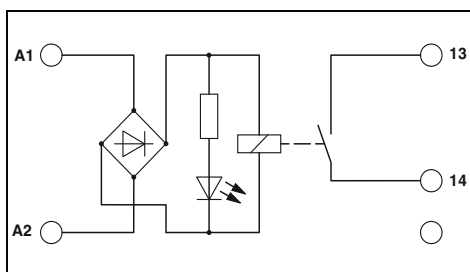

Technical data

②
0.8 - 1.1
6.5
5 / 15

Yellow LED, bridge rectifier

1 N/O contact
AgNi, hard gold-plated
250 V AC / 125 V DC
0.1 V
3 A (5 A up to 35°C at 24 V DC)
5 A
1 mA

72 W
60 W
50 W
50 W
750 VA

2 kV AC (50 Hz, 1 min.)
-20°C ... 50°C
Approx. 2x 10⁷ cycles
IEC 60664, EN 50178
0.2 - 2.5 mm² / 0.2 - 2.5 mm² / 24 - 14
6.2 mm / 80 mm / 56 mm
Class A product, see page 583

Ordering data

Type	Order No.	Pcs./Pkt.
DEK-REL- 24/1/AKT	2964063	10

Accessories

Accessories	Order No.	Pcs./Pkt.
DIKD 1,5	2715979	50
D-DEK 1,5 GN	2716949	10
EB 80- DIK BU	26 A 2715940	1
EB 80- DIK RD	26 A 2715953	1
EB 80- DIK WH	26 A 2715788	1

us ERC

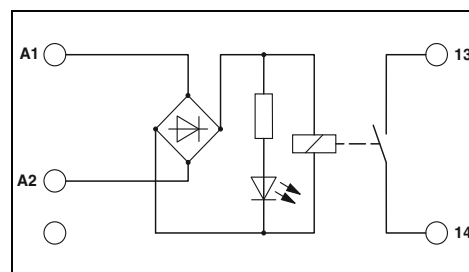

Technical data

②
0.8 - 1.1
6.5
5 / 15

Yellow LED, bridge rectifier

1 N/O contact
AgNi, hard gold-plated
250 V AC / 125 V DC
0.1 V
3 A (5 A up to 35°C at 24 V DC)
5 A
1 mA

72 W
60 W
50 W
50 W
750 VA

2 kV AC (50 Hz, 1 min.)
-20°C ... 50°C
Approx. 2x 10⁷ cycles
IEC 60664, EN 50178
0.2 - 2.5 mm² / 0.2 - 2.5 mm² / 24 - 14
6.2 mm / 80 mm / 56 mm
Class A product, see page 583

Ordering data

Type	Order No.	Pcs./Pkt.
DEK-REL- 24/1/SEN	2964050	10

Accessories

Accessories	Order No.	Pcs./Pkt.
DIKD 1,5	2715979	50
D-DEK 1,5 GN	2716949	10
EB 80- DIK BU	26 A 2715940	1
EB 80- DIK RD	26 A 2715953	1
EB 80- DIK WH	26 A 2715788	1

Relay modules

Relay modules in terminal block design – DEK series

Solid-state relay terminal blocks DEK-OE... and DEK-OV...

Phoenix Contact DEK-OE and DEK-OV interface terminal blocks are only 6.2 mm wide but still provide a complete input or output interface with:

- Electrical isolation between input and output at up to 2.5 kV_{rms}
- Integrated input circuit
- Status display
- Insertion bridges EB-DIK
- Labeling and mounting with modular terminal block convenience
- Wear-free switching up to 24 V DC/10 A and 240 V AC/800 mA
- Integrated output protection circuit
- Zero voltage switch at AC output
- Actuator version available.

Notes:
Type of housing: Polyamide PA non-reinforced, color: green.
Marking systems and mounting material See Catalog 3
For the protection of input and output, inductive loads must be dampened with an effective protection circuit.
Other insertion bridges EB...DIK... refer to page 445

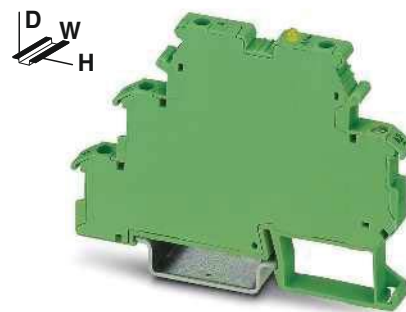

With DC voltage output
max. = 100 mA

ERC

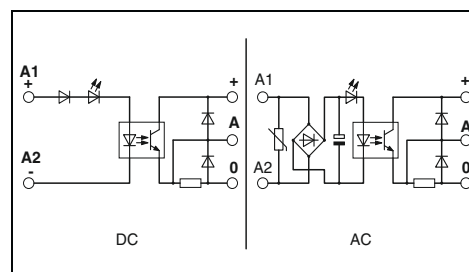

Derating curve for DEK-OV...24DC/3 and DEK-OV-24DC/24DC/3/AKT

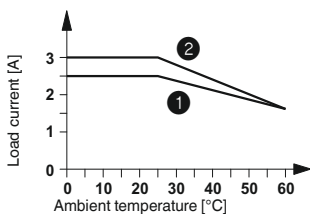

- ① Horizontal mounting
- ② Vertical mounting

Derating curve for DEK-OV-24DC/24DC/10

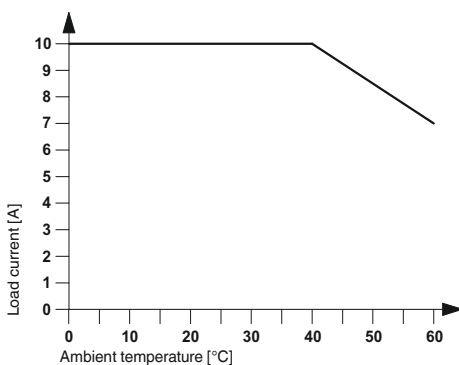

Derating curve for DEK-OV...240AC/800

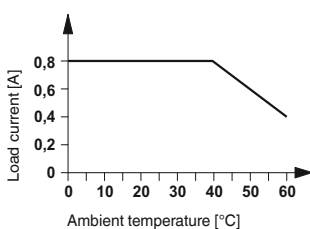

Input data	
Permissible range (with reference to U _N)	
Switching level with reference to U _N	1 signal ("H") 0 signal ("L")
Typical input current at U _N	[mA]
Transmission frequency f _{limit}	[Hz]
Input circuit AC	
Input circuit DC	
Output data	
Operating voltage range	
Periodic peak reverse voltage	
Limiting continuous current	
Minimum load current	
Surge current	
Leakage current in off state	
Max. load value	
Output protection	
Voltage drop at maximum limiting continuous current	
General data	
Test voltage input/output	
Ambient temperature (operation)	
Standards/regulations	
Degree of pollution/surge voltage category	
Connection data solid/stranded/AWG	
Dimensions	W / H / D
EMC note	

Technical data					
①	②	③	④	⑤	⑥
0.9 - 1.1	0.8 - 1.2	0.8 - 1.2	0.8 - 1.2	0.9 - 1.1	0.9 - 1.1
≥0.8	≥0.8	≥0.8	≥0.8	≥0.8	≥0.9
≤0.4	≤0.4	≤0.4	≤0.4	≤0.4	≤0.4
6.5	11	7	4	3.2	2.5
300	300	300	300	3	3
Yellow LED, reverse polarity protection, surge protection					
Yellow LED, reverse polarity protection					
3 V DC ... 48 V DC					
-					
100 mA					
-					
-					
-					
Reverse polarity protection, free-wheeling diode					
≤0.9 V					
2.5 kV (50 Hz, 1 min.)					
-20°C ... 60°C					
IEC 60664, EN 50178					
2 / III					
0.2 - 2.5 mm ² / 0.2 - 2.5 mm ² / 24 - 14					
6.2 mm / 80 mm / 56 mm					
Class A product, see page 583					

Description	Input voltage U _N
Solid-state input relays	
①	5 V DC
②	12 V DC
③	24 V DC
④	60 V DC
⑤	120 V AC
⑥	230 V AC
Solid-state power relays	
①	5 V DC
②	12 V DC
③	24 V DC
⑦	24 V DC
Actuator principle	

Insertion bridge, for middle and lower levels	No. of pos.	Color
	80	blue
	80	red
	80	white

Ordering data

Type	Order No.	Pcs./Pkt.
DEK-OE- 5DC/ 48DC/100	2940223	10
DEK-OE- 12DC/ 48DC/100	2964487	10
DEK-OE- 24DC/ 48DC/100	2940207	10
DEK-OE- 60DC/ 48DC/100	2941536	10
DEK-OE-120AC/ 48DC/100	2941659	10
DEK-OE-230AC/ 48DC/100	2940210	10

Accessories

Accessories	Order No.	Pcs./Pkt.
EB 80- DIK BU	26 A 2715940	1
EB 80- DIK RD	26 A 2715953	1
EB 80- DIK WH	26 A 2715788	1

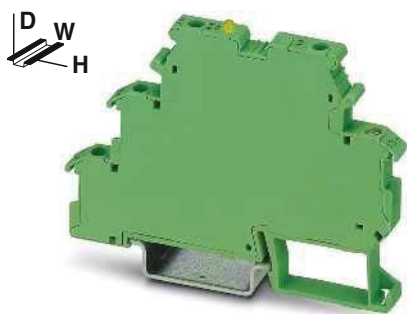

With DC voltage output
max. = 3 A

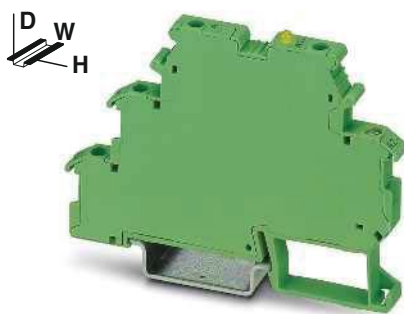

With DC voltage output
max. = 10 A

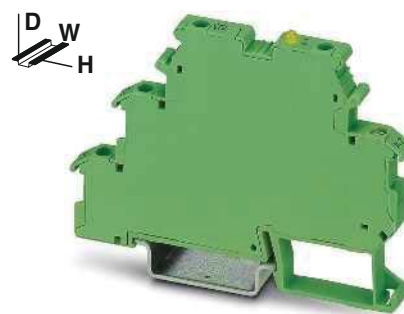

With AC voltage output
max. = 800 mA

ERC

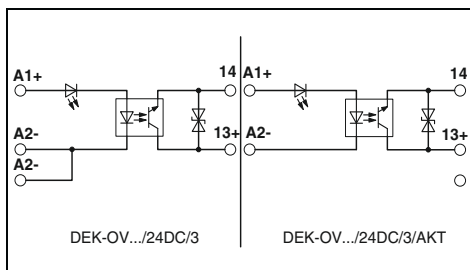

us ERC

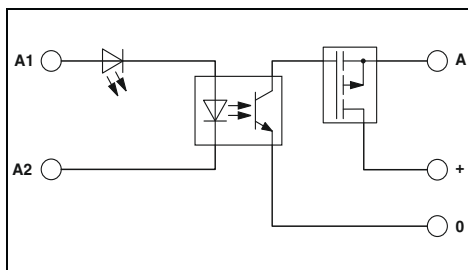

ERC

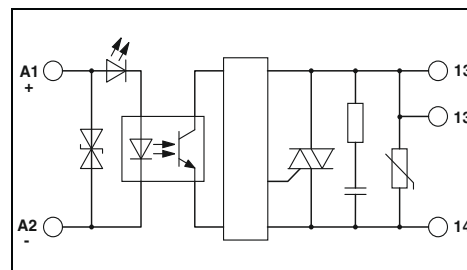

Technical data

①	②	③	⑦
0.8 - 1.2	0.8 - 1.2	0.8 - 1.2	0.8 - 1.2
≥0.8	≥0.8	≥0.8	≥0.8
≤0.4	≤0.4	≤0.4	≤0.4
11	8.5	7	7
300	300	300	300

Yellow LED, reverse polarity protection

3 V DC ... 30 V DC

3 A (see derating curve)

Reverse polarity protection, surge protection
≤0.2 V

2.5 kV (50 Hz, 1 min.)

-20°C ... 60°C

IEC 60664, EN 50178

2 / III

0.2 - 2.5 mm² / 0.2 - 2.5 mm² / 24 - 14

6.2 mm / 80 mm / 56 mm

Class A product, see page 583

Technical data

①	②	③
0.8 - 1.2	0.8 - 1.2	0.8 - 1.2
≥0.8	≥0.8	≥0.8
≤0.4	≤0.4	≤0.4
5.1	4.7	3.5
100	100	100

Yellow LED, reverse polarity protection, surge protection

5 V DC ... 30 V DC

10 A (see derating curve)

100 A (t = 20 ms)

Reverse polarity protection, surge protection
≤50 mV

2.5 kV (50 Hz, 1 min.)

-20°C ... 60°C

IEC 60664, EN 50178

2 / III

0.2 - 2.5 mm² / 0.2 - 2.5 mm² / 24 - 14

6.2 mm / 80 mm / 56 mm

Class A product, see page 583

Technical data

①	②	③
0.8 - 1.2	0.8 - 1.2	0.8 - 1.2
≥0.8	≥0.8	≥0.8
≤0.4	≤0.4	≤0.4
10.2	10.5	10.7
10	10	10

Yellow LED, reverse polarity protection, surge protection

10 V AC ... 253 V AC (50/60 Hz)

600 V

0.8 A (see derating curve)

10 mA

30 A (t = 10 ms)

1.2 mA

4.5 A²s

RCV circuit

≤1 V

2.5 kV (50 Hz, 1 min.)

-20°C ... 60°C

IEC 60664, EN 50178

2 / III

0.2 - 4 mm² / 0.2 - 2.5 mm² / 24 - 12

6.2 mm / 80 mm / 56 mm

Ordering data

Type	Order No.	Pcs./Pkt.
DEK-OV- 5DC/ 24DC/ 3	2941361	10
DEK-OV- 12DC/ 24DC/ 3	2941387	10
DEK-OV- 24DC/ 24DC/ 3	2941374	10
DEK-OV- 24DC/ 24DC/ 3/AKT	2964296	10

Ordering data

Type	Order No.	Pcs./Pkt.
DEK-OV- 5DC/ 24DC/ 10	2961752	10
DEK-OV- 12DC/ 24DC/ 10	2961749	10
DEK-OV- 24DC/ 24DC/ 10	2964322	10

Ordering data

Type	Order No.	Pcs./Pkt.
DEK-OV- 5DC/240AC/800	2964623	10
DEK-OV- 12DC/240AC/800	2964636	10
DEK-OV- 24DC/240AC/800	2964649	10

Accessories

EB 80- DIK BU	26 A	2715940	1
EB 80- DIK RD	26 A	2715953	1
EB 80- DIK WH	26 A	2715788	1

Accessories

EB 80- DIK BU	26 A	2715940	1
EB 80- DIK RD	26 A	2715953	1
EB 80- DIK WH	26 A	2715788	1

Accessories

EB 80- DIK BU	26 A	2715940	1
EB 80- DIK RD	26 A	2715953	1
EB 80- DIK WH	26 A	2715788	1



Switch/relay terminal blocks DEK-REL-24/1/S

The functions “Manual”, “0”, “Automatic” are provided in a 6.2 mm narrow relay terminal block.

Interference-free relay and solid-state relay interfaces

Coupled interference voltages on the coil lines or leakage currents can cause malfunctions in conventional modules. These special interface modules, equipped with high switching thresholds and/or effective filters, ensure good functioning.

Relay interfaces for switching lamp loads ST-REL... and EMG 17-REL...

Lamp loads and capacitive consumers produce extremely high inrush currents which weld conventional relay contacts. To prevent this, Phoenix Contact uses an arc-resistant contact optimized for these applications, which keeps these peaks under control.

Plug-in solid-state power relays ST-OV 3-24DC/400/3

The output of this component, dimensioned with a peak reverse voltage of 800 V, allows, for example, 230 V motors to be driven in simple reversible mode.

Power circuit breaker solid-state relays, with logic

These modules combine the features of a short-circuit proof power solid-state relay and those of a thermomagnetic protection element.

100-kHz input solid-state relay DEK-OE-...100KHZ

Input solid-state relay for reliable transmission of high-frequency signals, such as those that occur with incremental encoders, for example.

Electronic sensor terminal blocks for NAMUR proximity sensors

For converting the changeable resistance of a NAMUR sensor into a digital signal that can be read by a PLC.

Inverter module DEK-TR/INV

Module for converting NPN outputs to PNP outputs and PNP to NPN.

Relay modules with manual switch

Relay modules with manual switch and integrated power relay for manual, zero, and automatic functions

The advantages:

- Maximum switching current 5 A
- Width of only 6.2 mm
- Increased contact stability thanks to double contact
- Safe isolation in accordance with DIN EN 50178 between coil and contact

Notes:
Type of housing: Polyamide PA non-reinforced, color: green.
Marking systems and mounting material See Catalog 3
For the protection of input and output, inductive loads must be dampened with an effective protection circuit.
Use of EB 80-DIK... bridges in the DEK terminal blocks: Absorption of humidity from the ambient air as well as an unfavorable tolerance between a larger number of DEK terminal blocks and the EB 80-DIK... bridge may cause (minor) expansion of the DEK housing. When the EB 80-DIK... bridges are used, therefore, it is recommended that these be disconnected after about 10 to 12 DEK terminal blocks and a wire bridge to the next DEK terminal block be inserted in their place.

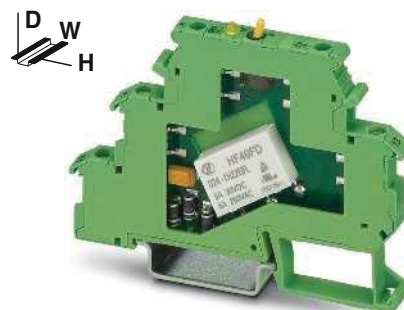

Relay module with manual switch and integrated relay

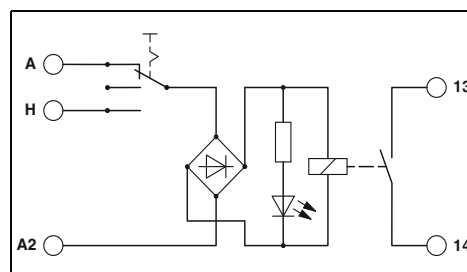

Technical data

Input data	①
Permissible range (with reference to U_N)	0.8 - 1.1
Typical input current at U_N [mA]	6.5
Response/release time at U_N [ms]	5 / 15
Input protection:	Yellow LED, bridge rectifier
Output data	
Contact type	1 N/O contact
Contact material	AgNi, hard gold-plated
Max. switching voltage	250 V AC / 125 V DC
Minimum switching voltage	0.1 V
Limiting continuous current	3 A (5 A up to 35°C at 24 V DC)
Maximum switch-on current	5 A
Minimum switching current	1 mA
Maximum interrupting rating, ohmic load	
	24 V DC 72 W
	48 V DC 60 W
	60 V DC 50 W
	110 V DC 50 W
	250 V AC 750 VA
General data	
Test voltage (winding/contact)	2 kV AC (50 Hz, 1 min.)
Ambient temperature (operation)	-20°C ... 50°C
Mechanical service life	Approx. 2×10^7 cycles
Standards/regulations	IEC 60664, EN 50178
Connection data solid/stranded/AWG	0.2 - 2.5 mm ² / 0.2 - 2.5 mm ² / 24 - 14
Dimensions W / H / D	6.2 mm / 80 mm / 61 mm
EMC note	Class A product, see page 583

Ordering data

Description	Input voltage U_N	Type	Order No.	Pcs./Pkt.
Relay module with power relay	① 24 V AC/DC	DEK-REL- 24/1/S	2964131	10

Accessories

Cover	Poles	Color	D-DEK 1,5 GN	2716949	10
Insertion bridge	2	red	EB 2- DIK RD	2716693	10
	3	red	EB 3- DIK RD	2716745	10
	4	red	EB 4- DIK RD	2716758	10
	5	red	EB 5- DIK RD	2716761	10
	10	red	EB 10- DIK RD	2716774	10
	5	blue	EB 5- DIK BU	2716677	10
	10	blue	EB 10- DIK BU	2716680	10
	80	blue	EB 80- DIK BU	2715940	1
	80	red	EB 80- DIK RD	2715953	1

Relay modules

Special relays and solid-state relays

Relay modules with interference current filter

Relay and solid-state relay modules with integrated filter to protect against interference voltages or currents due, for example, to long control lines

The advantages:

- Resistant to interference currents
 - High relay release voltage
- Typical applications:
- Applications with long control lines
 - Use of AC output boards, resulting in residual AC currents

Notes:
Load current diagrams, see page 402



1 changeover contact, plug-in relay

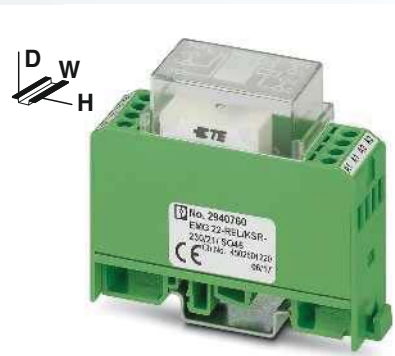

1 changeover contact, soldered-in relay

ERIC

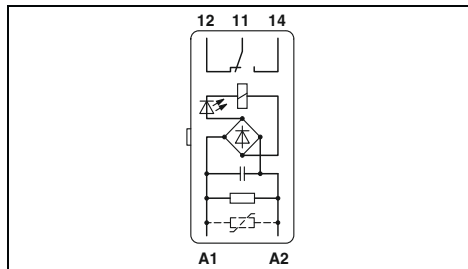

Technical data

Input data	①	②	③
Permissible range (with reference to U_N)	0.9 - 1.1	0.85 - 1.1	0.9 - 1.1
Typical input current at U_N [mA]	26	19	18
Response/release time at U_N [ms]	8 / 10	8 / 11	10 / 8
Input protection:	Yellow LED, bridge rectifier, surge protection		
Output data	Single contact, 1-PDT		Double contact, 1 PDT
Contact type	AgNi		Au
Contact material	250 V AC/DC		30 V AC / 36 V DC
Max. switching voltage	6 A		0.5 A
Limiting continuous current	8 A		0.2 A
Maximum switch-on current	24 V DC 140 W		5 W
Maximum interrupting rating, ohmic load	48 V DC 60 W		-
	60 V DC 45 W		-
	110 V DC 35 W		-
	220 V DC 55 W		-
	250 V AC 1,500 VA		-
General data	2.5 kV AC (50 Hz, 1 min.)		
Test voltage (winding/contact)	-20°C ... 50°C		
Ambient temperature (operation)	Approx. 2×10^7 cycles		
Mechanical service life	IEC 60664, EN 50178		
Standards/regulations	- / - / -		
Connection data solid/stranded/AWG	W / H / D 20.8 mm / 42.5 mm / 112 mm		
Dimensions	EMC note		

ERIC

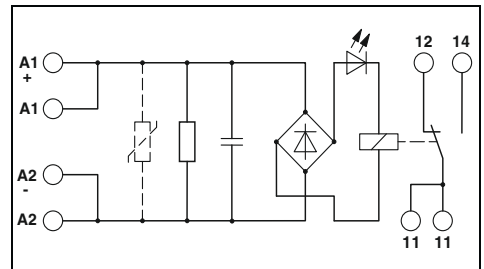

Technical data

Input data	③		
Permissible range (with reference to U_N)	0.9 - 1.1		
Typical input current at U_N [mA]	18		
Response/release time at U_N [ms]	10 / 8		
Input protection:	Yellow LED, bridge rectifier, surge protection		
Output data	Single contact, 1-PDT		Double contact, 1 PDT
Contact type	AgNi		AgPd60, hard gold-plated
Contact material	250 V AC/DC		30 V AC / 36 V DC
Max. switching voltage	6 A		0.5 A
Limiting continuous current	8 A		0.2 A
Maximum switch-on current	95 W		5 W
Maximum interrupting rating, ohmic load	50 W		-
	45 W		-
	35 W		-
	55 W		-
	1,500 VA		-
General data	2.5 kV AC (50 Hz, 1 min.)		
Test voltage (winding/contact)	-20°C ... 40°C		
Ambient temperature (operation)	Approx. 2×10^7 cycles		
Mechanical service life	IEC 60664, EN 50178		
Standards/regulations	0.2 - 4 mm ² / 0.2 - 2.5 mm ² / 24 - 12		
Connection data solid/stranded/AWG	22.5 mm / 75 mm / 62.5 mm		
Dimensions	Class A product, see page 583		
EMC note			

Ordering data

Description	Input voltage U_N	Type	Order No.	Pcs./Pkt.
Relay module with power contact-relay	① 24 V AC	ST-REL3-KG 24/21/SO46	2826091	10
	② 120 V AC	ST-REL3-KG120/21/SO46	2833026	10
	③ 230 V AC	ST-REL3-KG230/21/SO46	2832027	10
Relay module with multi-layer contact relay	① 24 V AC	ST-REL3-KG 24/21/AU/SO46	2826981	10
	② 120 V AC	ST-REL3-KG120/21/AU/SO46	2829797	10
	③ 230 V AC	ST-REL3-KG230/21/AU/SO46	2826266	10

Ordering data

Type	Order No.	Pcs./Pkt.
EMG 22-REL/KSR-230/21/ SO46	2940760	10
EMG 22-REL/KSR-230/21/AU/SO46	2940061	10

Accessories

Basic terminal block, complete with end cover	URELG 3	2820136	10
Equipment marker			

Accessories

	EMG-GKS 12	2947035	50
--	------------	---------	----

Notes:

Type of housing:
ST-REL: Polyamide non-reinforced PA, color: bottom part gray, hood green
EMG: Polyamide fiber reinforced PA-F, color: green.
DEK: Polyamide non-reinforced PA, color: green.

Marking systems and mounting material
 See Catalog 3

For derating curve, refer to page 401

Use of EB 80-DIK... bridges in the DEK terminal blocks:
 Absorption of humidity from the ambient air as well as an unfavorable tolerance between a larger number of DEK terminal blocks and the EB 80-DIK... bridge may cause (minor) expansion of the DEK housing. When the EB 80-DIK... bridges are used, therefore, it is recommended that these be disconnected after about 10 to 12 DEK terminal blocks and a wire bridge to the next DEK terminal block be inserted in their place.

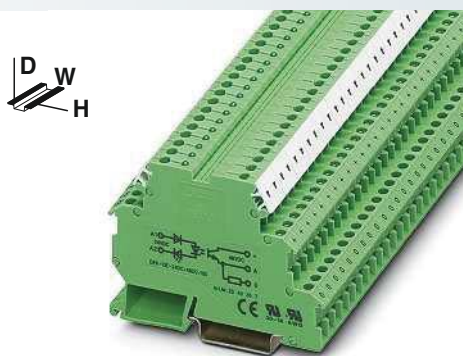

Solid-state input relay
max. 100 mA

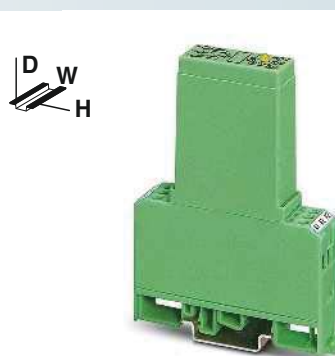

Solid-state power relay
max. 2 A

ERC

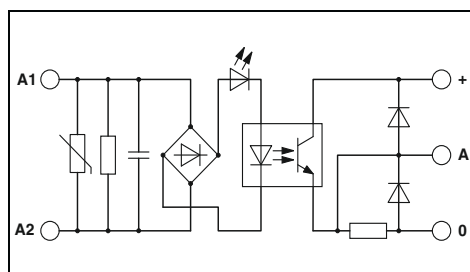

Technical data

Input data		②
Permissible range (with reference to U_N)		0.9 - 1.1
Switching level	1 signal ("H") [V DC] \geq 0 signal ("L") [V DC] \leq	207 92
Typical input current at U_N	[mA]	2.5
Typical switch-on time at U_N	[ms]	4.4
Typical switch-off time at U_N	[ms]	14
Transmission frequency f_{limit}	[Hz]	5
Input circuit AC		Yellow LED, surge protection, RC element

Input circuit DC		
Output data		
Max. switching voltage		48 V DC
Minimum switching voltage		3 V DC
Limiting continuous current		100 mA
Maximum switch-on current		-
Output circuit		3-conductor, ground-referenced
Output protection		Reverse polarity protection, free running
Voltage drop at maximum limiting continuous current		≤ 0.9 V

General data		
Test voltage input/output		2.5 kV AC
Ambient temperature (operation)		0°C ... 50°C
Standards/regulations		IEC 60664, EN 50178
Degree of pollution/surge voltage category		2 / III

Mounting position/mounting		Any / in rows with zero spacing
----------------------------	--	---------------------------------

Connection data solid/stranded/AWG		0.2 - 2.5 mm ² / 0.2 - 2.5 mm ² / 24 - 12
Dimensions	W / H / D	6.2 mm / 80 mm / 56 mm
EMC note		

Ordering data

Description	Input voltage U_N
Solid-state power relays	
	① 24 V DC
	② 230 V AC

Type	Order No.	Pcs./Pkt.
DEK-OE-230AC/ 48DC/100/SO 46	2964678	10

Accessories

Equipment marker		
-------------------------	--	--

ERC

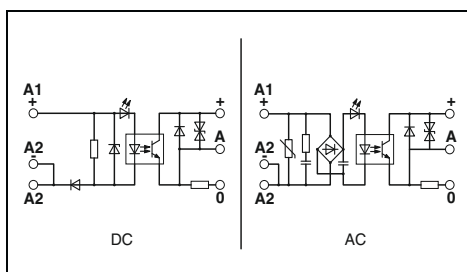

Technical data

Input data		①
Permissible range (with reference to U_N)		0.8 - 1.2
Switching level		16.8
Typical input current at U_N		16
Typical switch-on time at U_N		8
Typical switch-off time at U_N		0.02
Transmission frequency f_{limit}		0.2
Input circuit AC		300

Input circuit DC		
Output data		
Max. switching voltage		48 V DC
Minimum switching voltage		12 V DC
Limiting continuous current		2 A (see derating curve)
Maximum switch-on current		5 A (t = 1 s)
Output circuit		3-conductor, ground-referenced
Output protection		Reverse polarity protection, surge protection
Voltage drop at maximum limiting continuous current		1.1 V

General data		
Test voltage input/output		3.5 kV AC
Ambient temperature (operation)		-10°C ... 55°C
Standards/regulations		IEC 60664, EN 50178
Degree of pollution/surge voltage category		2 / III

Mounting position/mounting		- / mounted in rows with zero spacing: horizontal/not in rows: any
----------------------------	--	--

Connection data solid/stranded/AWG		0.2 - 4 mm ² / 0.2 - 2.5 mm ² / 24 - 12
Dimensions		17.5 mm / 75 mm / 102 mm
EMC note		Class A product, see page 583

Ordering data

Type	Order No.	Pcs./Pkt.
EMG 17-OV- 24DC/ 48DC/2	2942810	10

Accessories

Equipment marker		
EMG-GKS 12	2947035	50

Relay modules

Special relays and solid-state relays

Relay modules for high inrush currents

The Phoenix Contact relay modules of the type SO 38 have been designed for switching electrical equipment with high inrush currents.

Areas of application are:

- Inductive loads (motors, power contactors etc.)
- Inductive/capacitive loads (fluorescent lamps etc.)
- Ohmic loads (glow lamps, heaters).

The module is based on a relay with a special arc-resistant tungsten lead contact. This takes over the high inrush and interrupting current capacitively. The inductive main contact made of AgCdO takes over the continuous current up to 10 A reliably. With the model EMG 17-REL...2E/SO38, this switching capacity is reached using a power relay with a set of silver tin oxide (AgSnO) contacts.

The module is available in two versions:

- Modular EMG housing that can be mounted on a DIN rail, with an overall width of 17.5 mm
 - Convenient plug-in housing ST-REL from the Phoenix ST series for mounting on the basic terminal blocks URELG or UDK-RELG
- Further features are:
- Snap-on mounting on the common EN rails
 - Easy maintenance
 - Clear labeling of the terminal blocks using Phoenix Contact marking material

Notes:
Type of housing: Polycarbonate fiber reinforced PC-F, color: green or black.
Marking systems and mounting material See Catalog 3



Medium to high powers
1 N/O contact (1)

ERC

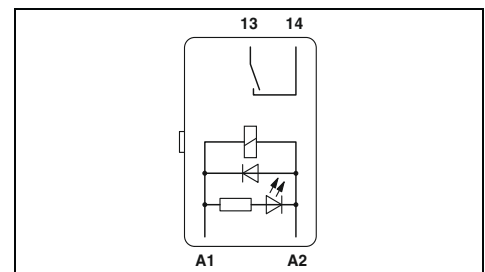

Technical data

Input data		①
Permissible range (with reference to U_N)		0.85 - 1.1
Typical input current at U_N	[mA]	28
Response/release time at U_N	[ms]	13 / 15
Input protection:		Yellow LED, free-wheeling diode
Output data		
Contact type		1 N/O contact with lead contact
Contact material		AgCdO
Max. switching voltage		250 V AC
Limiting continuous current		10 A
Maximum switch-on current		80 A (20 ms)
Maximum interrupting rating, ohmic load		
	24 V DC	-
	48 V DC	-
	60 V DC	-
	110 V DC	-
	220 V DC	-
	250 V AC	2500 VA
General data		
Test voltage (winding/contact)		2.5 kV AC (50 Hz, 1 min.)
Ambient temperature (operation)		-20°C ... 50°C
Mechanical service life		Approx. 10 ⁷ cycles
Standards/regulations		IEC 60664, EN 50178
Mounting position/mounting		- / horizontal with zero spacing, vertical with spacing
Connection data solid/stranded/AWG		- / - / -
Dimensions	W / H / D	20.8 mm / 42.5 mm / 112 mm
EMC note		

Ordering data

Description	Input voltage U_N	Type	Order No.	Pcs./Pkt.
Relay module with power contact-relay + wolfram lead contact	① 24 V DC	ST-REL3-KG 24/ 1/SO38	2829564	10
Relay module with power contact relay, with two inputs for manual, automatic	① 24 V DC			

Accessories

Basic terminal block, complete with end cover	URELG 3	2820136	10
Equipment marker			



Medium to high powers
1 N/O contact (1)

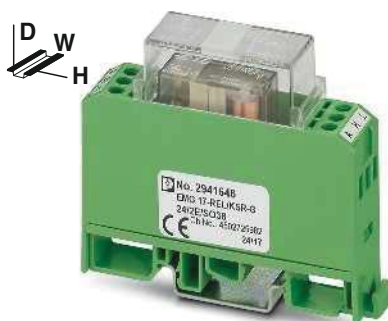

Medium to high powers
1 N/O contact (1)

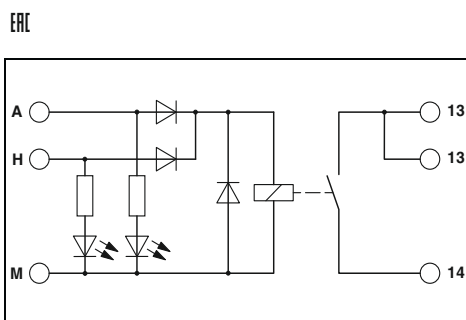
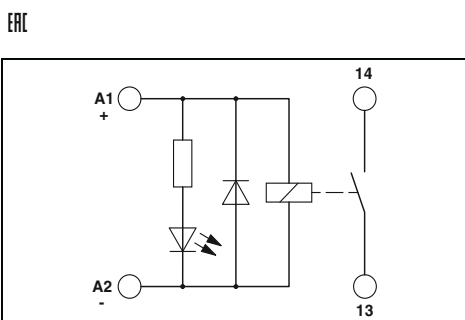

Technical data

①
0.85 - 1.1
28
13 / 15
Yellow LED, free-wheeling diode
1 N/O contact with lead contact
AgSnO ₂
250 V AC
10 A
80 A (20 ms)
-
-
-
-
-
2500 VA
4 kV AC (50 Hz, 1 min.)
-20°C ... 50°C
Approx. 10 ⁷ cycles
IEC 60664, EN 50178
Any
0.2 - 4 mm ² / 0.2 - 2.5 mm ² / 24 - 12
17.5 mm / 75 mm / 62.5 mm
Class A product, see page 583

Technical data

①
0.9 - 1.1
23
9 / 10
Automatic: yellow LED, manual: red LED, free-wheeling diode, reverse polarity protection
Single contact, 1 N/O contact
AgSnO
250 V AC/DC
10 A
120 A (20 ms)
240 W
120 W
85 W
70 W
90 W
2500 VA
4 kV AC (50 Hz, 1 min.)
-20°C ... 50°C
3x 10 ⁷ cycles
IEC 60664, EN 50178
Any
0.2 - 4 mm ² / 0.2 - 2.5 mm ² / 24 - 12
17.5 mm / 75 mm / 62.5 mm
Class A product, see page 583

Ordering data

Type	Order No.	Pcs./Pkt.
EMG 17-REL/KSR-G 24/SO38 BK	2949994	10

Ordering data

Type	Order No.	Pcs./Pkt.
EMG 17-REL/KSR-G 24/2E/SO38	2941646	10

Accessories

EMG-GKS 12	2947035	50
------------	---------	----

Accessories

EMG-GKS 12	2947035	50
------------	---------	----

Special relays and solid-state relays

Pluggable solid-state power relays ST-OV 3

The pluggable version of the module provides all the advantages of the ST series, such as:

- Switching of up to 400 V AC/3 A
- Control of 230 V motors in straightforward reversing mode (e.g., synchronous motor in single-phase operation, see illustration)
- Pluggable

Notes:

Type of insulating housing: polyamide PA non-reinforced, color: bottom part gray, hood green

Ground (minus) potential from the input and output of the optocoupler should not be connected.

AC loads must be protected with a varistor or an RC element.



With AC voltage output
max. = 3 A

ERIC

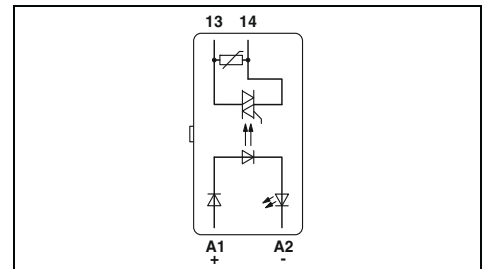

Technical data

Input data		①
Switching level with reference to U_N	1 signal ("H") 0 signal ("L")	≥ 0.8 ≤ 0.4
Typical input current at U_N	[mA]	7
Transmission frequency f_{limit}	[Hz]	10
Input protection:		Yellow LED, reverse polarity protection, RC element
Output data		
Operating voltage		400 V AC
Operating voltage range		24 V AC ... 420 V AC
Periodic peak reverse voltage		800 V
Limiting continuous current		3 A (see derating curve)
Minimum load current		50 mA
Surge current		125 A ($t = 10$ ms)
Residual voltage drop at "H"		≤ 1.2 V
Leakage current in off state		Approx. 12 mA
Output protection		Surge protection, RC element
General data		
Test voltage input/output		2.5 kV AC
Ambient temperature (operation)		0°C ... 60°C
Standards/regulations		IEC 60664, EN 50178
Degree of pollution/surge voltage category		2 / III
Mounting position/mounting		Horizontal DIN rail / -
Dimensions	W / H / D	20.8 mm / 42.5 mm / 112 mm

Ordering data

Description	Input voltage U_N	Type	Order No.	Pcs./Pkt.
Solid-state power relays	① 24 V DC	ST-OV3- 24DC/400AC/3	2905417	10

Accessories

Basic terminal block, complete with end cover	URELG 3	2820136	10
--	----------------	----------------	----

Derating curve for ST-OV 3-24DC/400AC/3

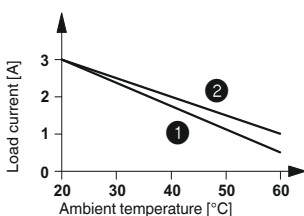

- ① Aligned without spacing
- ② Aligned with 20 mm spacing

Relay modules

Special relays and solid-state relays

100-kHz input solid-state relays DEK-OE

A solid-state relay for the reliable detection of short pulses

- Limit frequency of up to 100 kHz
- Push-pull stage on output side
- Includes signal inputs on PLC counter boards
- Features a capacitor on the input side for interference suppression

Notes:
Type of housing: Polyamide PA non-reinforced, color: green.
Marking systems and mounting material See Catalog 3
Use of EB 80-DIK... bridges in the DEK terminal blocks: Absorption of humidity from the ambient air as well as an unfavorable tolerance between a larger number of DEK terminal blocks and the EB 80-DIK... bridge may cause (minor) expansion of the DEK housing. When the EB 80-DIK... bridges are used, therefore, it is recommended that these be disconnected after about 10 to 12 DEK terminal blocks and a wire bridge to the next DEK terminal block be inserted in their place.

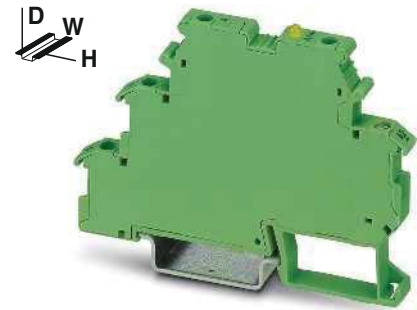

With DC voltage output
Transmission frequency 100 kHz

ERC

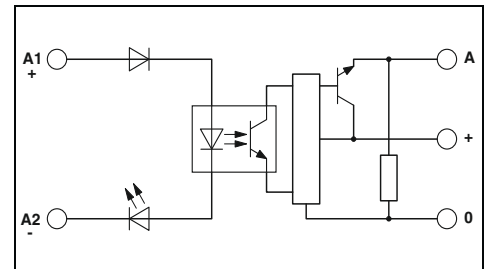

Technical data

		①	②
Input data			
Permissible range (with reference to U_N)		0.8 - 1.2	0.8 - 1.2
Switching level with reference to U_N	1 signal ("H")	≥ 0.8	≥ 0.8
	0 signal ("L")	≤ 0.4	≤ 0.4
Typical input current at U_N	[mA]	7	6
Typical switch-on time at U_N	[μ s]	1.5	1.5
Typical switch-off time at U_N	[μ s]	2	2
Transmission frequency f_{limit}	[kHz]	100	100
Input protection:		Yellow LED, reverse polarity protection, surge protection	
Output data			
Operating voltage range		4 V DC ... 30 V DC	
Limiting continuous current		50 mA	
Quiescent current		4.3 mA	
Residual voltage drop at "H"		≤ 0.5 V DC	
Output circuit		3-conductor, ground-referenced	
Output protection		Surge protection	
General data			
Test voltage input/output		2.5 kV AC	
Ambient temperature (operation)		-20°C ... 60°C	
Standards/regulations		IEC 60664, EN 50178	
Degree of pollution/surge voltage category		2 / II	
Connection data solid/stranded/AWG		0.2 - 4 mm ² / 0.2 - 2.5 mm ² / 24 - 12	
Dimensions	W / H / D	6.2 mm / 80 mm / 56 mm	
EMC note		Class A product, see page 583	

Ordering data

Description	Input voltage U_N	Type	Order No.	Pcs./Pkt.
Solid-state input relays	① 5 V DC	DEK-OE- 5DC/ 24DC/100KHZ	2964270	10
	② 24 V DC	DEK-OE- 24DC/ 24DC/100KHZ	2964283	10

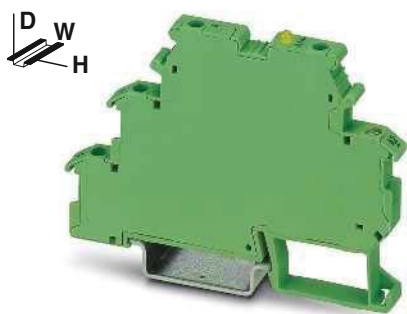

With DC voltage output push-pull
Transmission frequency 100 kHz

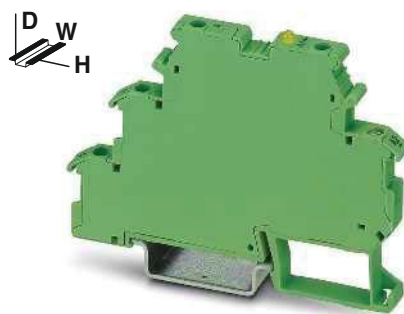

With DC voltage output push-pull
Transmission frequency 100 kHz

ERC

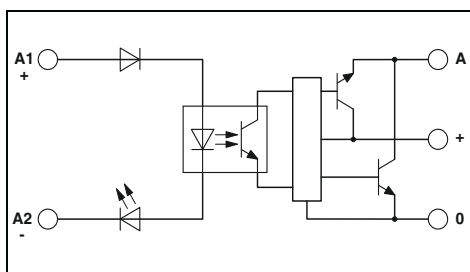

Technical data

①	②
0.5 - 1.2	0.8 - 1.2
≥0.5	≥0.8
≤0.3	≤0.4
8	8
1	1
2	2
100	100

Yellow LED, reverse polarity protection, surge protection

4 V DC ... 18 V DC
50 mA
8.5 mA
≤1.2 V DC
3-conductor push-pull, ground referenced
Surge protection

2.5 kV AC
-20°C ... 60°C
IEC 60664, EN 50178
2 / II

0.2 - 4 mm² / 0.2 - 2.5 mm² / 24 - 12
6.2 mm / 80 mm / 56 mm
Class A product, see page 583

Ordering data

Type	Order No.	Pcs./Pkt.
DEK-OE- 5DC/ 5DC/100KHZ-G	2964542	10
DEK-OE- 24DC/ 5DC/100KHZ-G	2964364	10

ERC

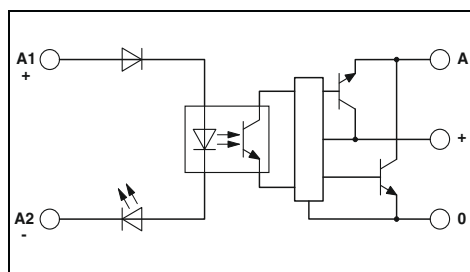

Technical data

①	②
0.5 - 1.2	0.8 - 1.2
≥0.5	≥0.8
≤0.3	≤0.4
8	8
1	1
2	2
100	100

Yellow LED, reverse polarity protection, surge protection

14 V DC ... 30 V DC
50 mA
15 mA
≤2.2 V DC
3-conductor push-pull, ground referenced
Surge protection

2.5 kV AC
-20°C ... 60°C
IEC 60664, EN 50178
2 / II

0.2 - 4 mm² / 0.2 - 2.5 mm² / 24 - 12
6.2 mm / 80 mm / 56 mm
Class A product, see page 583

Ordering data

Type	Order No.	Pcs./Pkt.
DEK-OE- 5DC/ 24DC/100KHZ-G	2964555	10
DEK-OE- 24DC/ 24DC/100KHZ-G	2964348	10

Special relays and solid-state relays

Electronic sensor terminal blocks for NAMUR proximity sensors

The electronic sensor terminal block, EIK 1-SVN 24-P from Phoenix converts the changeable resistance of a NAMUR sensor unit into a digital signal that can be read by all PLCs.

- Monitoring of initiator side for short circuits or strand breaks
- Suitable resistance circuit to enable monitoring of mechanical switches (see application 2)
- LED error display
- Status display (high signal) via green LED
- 24 V/50 mA digital output
- Bridging and marking with standard terminal accessories

Notes:

Type of housing:
Polyamide PA non-reinforced, color: green.

Marking systems and mounting material
See Catalog 3

Use of EB 80-DIK... bridges in the DEK terminal blocks:
Absorption of humidity from the ambient air as well as an unfavorable tolerance between a larger number of DEK terminal blocks and the EB 80-DIK... bridge may cause (minor) expansion of the DEK housing. When the EB 80-DIK... bridges are used, therefore, it is recommended that these be disconnected after about 10 to 12 DEK terminal blocks and a wire bridge to the next DEK terminal block be inserted in their place.

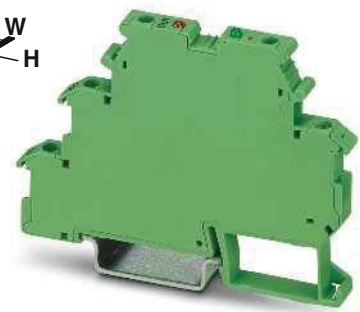

For inductive proximity sensors in accordance with NAMUR

Derating curve for EIK 1-SVN 24 P

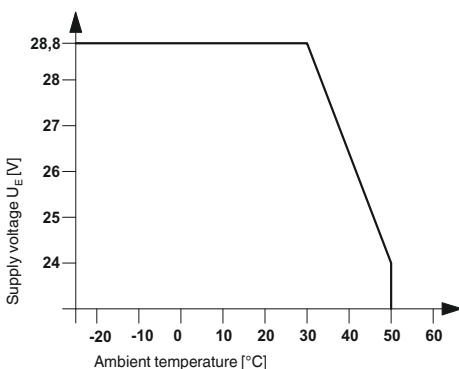

Application 1

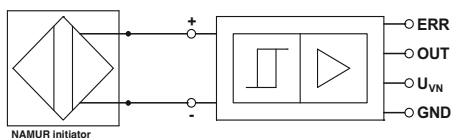

Application 2

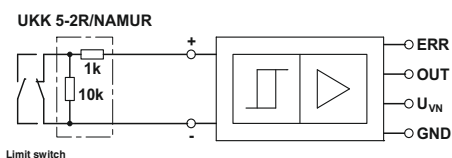

Supply

Input supply nominal voltage U_{VN}

Ripple

Current consumption I_{Imax}

Input circuit

Control circuit

Non-load voltage

Switching points in accordance with EN 60947-5-6:

Switching hysteresis

Internal resistance

Output protection

Signal output

Maximum output current I_{Amax}

Residual voltage U_R with I_{Omax}

Output voltage U_O

Output protection

General data

Ambient temperature (operation)

Transmission frequency (INPUT/OUTPUT)

Input pulse length

Input pause length

Standards/regulations

Degree of pollution/overvoltage category

Screw connection rigid / flexible / AWG

Dimensions

EMC note

W / H / D

ERIC

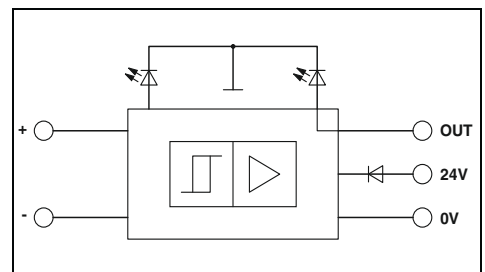

Technical data

18.5 V DC ... 28.8 V DC (U_{VN} , see derating curve)

In accordance with DIN 19240

70 mA (at 50 mA output current)

Green LED, polarity protection diode

8.2 V DC $\pm 10\%$

≥ 2.1 mA (in conductive state)

≤ 1.2 mA (in blocking state)

6.3 mA ... 10 mA (in the event of a short-circuit)

0 mA ... 0.35 mA (in the event of a wire break)

Approx. 0.2 mA

Approx. 1 k Ω

Visual short-circuit and wire break control with LED (red), 12 V Zener diode

50 mA

≤ 1.5 V (U_R)

≤ 100 mV (in conductive state)

$U_{VN} - U_R$; in blocking state

36 V Zener diode as free-wheeling diode

-25°C ... 50°C

1 kHz

≥ 0.5 ms

≥ 0.5 ms

IEC 60664, EN 61000-6-2, EN 61000-6-4

2 / III

0.2 - 4 mm² / 0.2 - 2.5 mm² / 24 - 12

6.2 mm / 80 mm / 56 mm

Class A product, see page 583

Ordering data

Type	Order No.	Pcs./Pkt.
EIK1-SVN-24P	2940799	10

Accessories

DIKD 1,5	2715979	50
UKK 5-2R/NAMUR	2941662	50
EB...-DIK...		
Ordering data at DEK-REL...		

Description

Switching amplifier electronic terminal block, for inductive proximity initiators as per NAMUR, with light indicators for sensor signal and faults

Terminal block, with three through contacts, for mounting on NS 35...

Double-level terminal block, with preassembled resistors

Insertion bridge

Inverter modules DEK-TR/INV

The DEK-TR/INV inverter module inverts the signals of ground-switching NPN transistor outputs into positive switching PNP outputs, as well as signals from PNP into NPN signals. See application example.

Notes:
Type of housing: Polyamide PA non-reinforced, color: green.
Marking systems and mounting material See Catalog 3
Use of EB 80-DIK... bridges in the DEK terminal blocks: Absorption of humidity from the ambient air as well as an unfavorable tolerance between a larger number of DEK terminal blocks and the EB 80-DIK... bridge may cause (minor) expansion of the DEK housing. When the EB 80-DIK... bridges are used, therefore, it is recommended that these be disconnected after about 10 to 12 DEK terminal blocks and a wire bridge to the next DEK terminal block be inserted in their place.

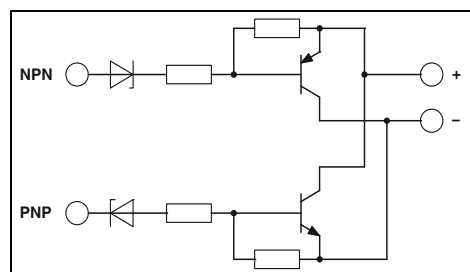
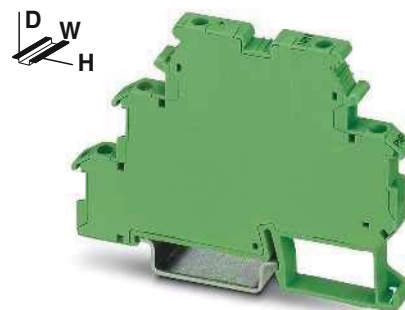

Technical data

Supply voltage	20 V DC ... 30 V DC (U_V)
Continuous current	200 mA
Residual voltage drop	<1 V
Leakage current	<1 mA
Maximum transmission frequency	15 kHz
NPN input/PNP output	
Switch-on threshold	<5 V (at $U_V = 24$ V; <($U_V - 19$ V))
Switch-off threshold	>15 V (at $U_V = 24$ V; >($U_V - 9$ V))
Minimum limit values	-2 V
Maximum limit values	26 V (at $U_V = 24$ V; $U_V + 2$ V)
Control circuit	
Switch-on threshold	>19 V
Switch-off threshold	<9 V
Minimum limit values	-2 V
Maximum limit values	26 V (at $U_V = 24$ V; $U_V + 2$ V)
General data	
Ambient temperature (operation)	-20°C ... 50°C
Standards/regulations	IEC 60664
	Basic insulation
	2 / II
Degree of pollution/overvoltage category	
Screw connection rigid / flexible / AWG	0.2 - 4 mm ² / 0.2 - 2.5 mm ² / 24 - 12
Dimensions	6.2 mm / 80 mm / 56 mm

Ordering data

Description	Type	Order No.	Pcs./Pkt.
Inverter module	DEK-TR/INV	2964319	10

Connection examples:

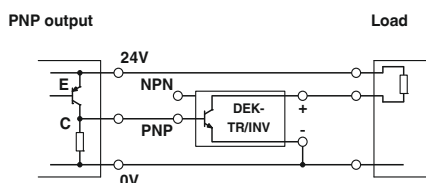
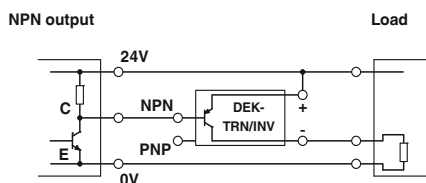

Relay modules

Special relays and solid-state relays

Hybrid relay modules

With its integrated transistor level, the hybrid relay module is able to amplify weak input signals. This serves as the basis for reliable relay operation.

The advantages:

- Low control current (terminal B), type-dependent as of 0.5 mA
- Integrated input and interference suppression circuit
- Safe isolation in accordance with DIN EN 50178 between coil and contact

Notes:
Type of housing: Polycarbonate fiber reinforced PC-F, color: green.
Marking systems and mounting material See Catalog 3
For the protection of relay coils and contacts, inductive loads must be damped with an efficient protection circuit.

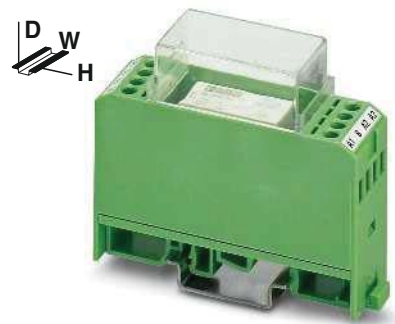

Positive switching hybrid relay

ERIC

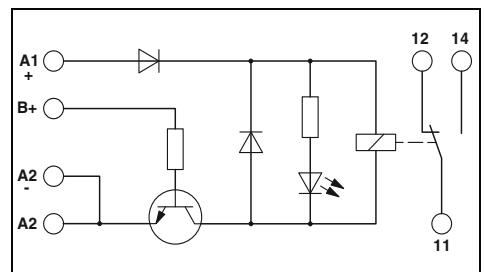

Technical data

Input data	①	②	③	
Relay supply voltage $U_N \pm 10\%$	[V DC]	24	24	24
Minimum control voltage	[V DC]	2.7	5	15
Maximum control voltage	[V DC]	5.25	13.2	35
Minimum control current	[mA]	2.6	0.5	0.5
Maximum control current	[mA]	7.7	1	1
Typical input current at U_N	[mA]	21	21	21
Response/release time at U_N	[ms]	9 / 10	9 / 10	9 / 10
Input protection:		Yellow LED, reverse polarity protection, free-wheeling diode		
Output data				
Contact type		Single contact, 1-PDT		
Contact material		AgNi		
Max. switching voltage		250 V AC/DC		
Limiting continuous current		5 A		
Maximum switch-on current		8 A		
Maximum interrupting rating, ohmic load				
	24 V DC	120 W		
	48 V DC	60 W		
	60 V DC	50 W		
	110 V DC	50 W		
	220 V DC	80 W		
	250 V AC	1250 VA		
General data				
Test voltage (winding/contact)		4 kV AC (50 Hz, 1 min.)		
Ambient temperature (operation)		-20°C ... 50°C		
Mechanical service life		Approx. 5×10^7 cycles		
Standards/regulations		IEC 60664, EN 50178		
Degree of pollution/surge voltage category		2 / III		
Connection data solid/stranded/AWG		0.2 - 4 mm ² / 0.2 - 2.5 mm ² / 24 - 12		
Dimensions	W / H / D	22.5 mm / 75 mm / 62.5 mm		
EMC note		Class A product, see page 583		

Ordering data

Description	Nominal control voltage	Type	Order No.	Pcs./Pkt.
Relay module with miniature power contact relay with integrated NPN transistor control, for low control currents	① 5 V DC	EMG 22-REL/KSR-G 24/TRN 5	2949787	10
	② 12 V DC	EMG 22-REL/KSR-G 24/TRN12	2952363	10
	③ 24 V DC	EMG 22-REL/KSR-G 24/TRN35	2952350	10

Accessories

Equipment marker	EMG-GKS 12	2947035	50
-------------------------	------------	---------	----

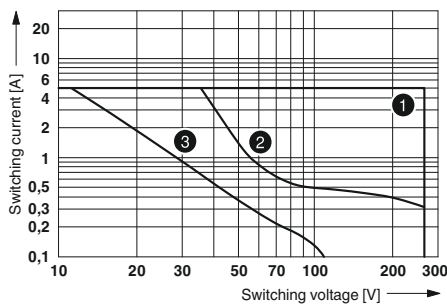

- ① AC, ohmic load
- ② DC, ohmic load
- ③ DC, L/R = 40 ms

Interrupting rating



System cabling for controllers

Wiring I/O modules with individual wires is an extremely time-consuming process. Wiring errors and tedious troubleshooting cannot be ruled out.

VARIOFACE system components reduce assembly costs by using plug-in components to carry out wiring quickly, clearly, and without errors.

In the case of **controller-specific system cabling**, front adapters, system cables, and modules are specially matched to each other. Individual solutions exist for the following controllers:

- **ABB**
- **Allen Bradley**
- **Emerson**
- **Honeywell**
- **Phoenix Contact**
- **Mitsubishi Electric**
- **OMRON**
- **Schneider Electric**
- **Siemens**
- **Yokogawa**

If automation components with high-pos. connectors such as D-SUB are in the control cabinet, **universal modules** and cables are suitable for signal connection. The 1:1 connection is characteristic for these universal all-purpose modules. The modules allow orderly connection of field signals to screw, spring-cage or Push-in Technology.

Universal cables connect the control and signal level fast and without errors.

A wide variety of **potential distributors** are available for splitting the control and operating voltage. The different potential levels and the connection terminal blocks make flexible use possible.

Individual application requirements can be realized with customer-specific products (see page 466).

Product range overview

Introduction	460
Product overview	462
<hr/>	
Customer-specific products	466
<hr/>	
Controller-specific system cabling	
For ABB S800 I/O	468
For Allen Bradley, ControlLogix, SLC 500, and PlantScape	470
For Emerson DeltaV	476
For Honeywell C300 Series C I/O and PlantScape	480
For Mitsubishi MELSEC Q and L	482
For OMRON CJ1, CS1, and C200H	484
For Phoenix Contact Axioline and Inline	485
For Schneider Electric Modicon	488
For Siemens SIMATIC® S7-1500	492
For Siemens SIMATIC® S7-300	496
For Siemens SIMATIC® S7-400	508
For Siemens SIMATIC® ET 200SP HA	512
For Yokogawa CENTUM VP, ProSafe-RS	514
Passive modules	516
Active modules	524
V8 adapter for PLC-INTERFACE	528
System and splitting cable	537
<hr/>	
Retrofit and modernization components	538
<hr/>	
Universal modules	
With IDC/FLK connectors	548
With D-SUB connectors	552
With high-density D-SUB connectors	558
With RJ45 connectors	559
With ELCO connectors	560
<hr/>	
Universal cables	
With IDC/FLK connectors	562
With D-SUB connectors	570
<hr/>	
Potential distributors	578

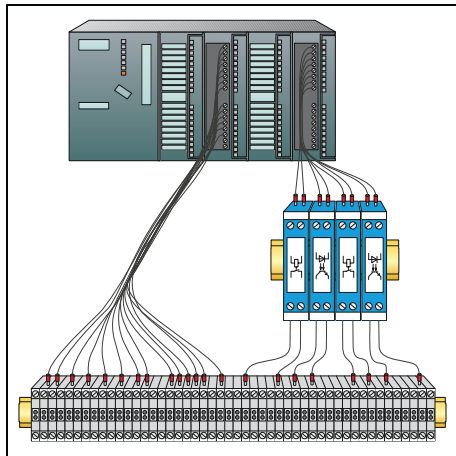

Wiring with single wires

- Time-consuming
- Confusing wiring
- Risk of mixing wires
- Time-consuming troubleshooting

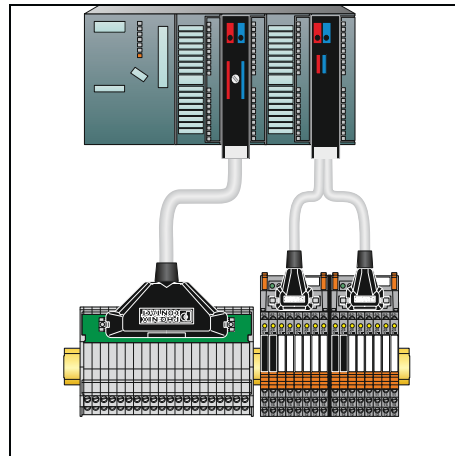

Wiring with the controller-specific system cabling:

- Fast, fault-free wiring
- Plug and Play solution
- Orderly structure
- Considerable time savings



The matching components are selected with the help of the “system cabling for controllers” online configurator:

- Front adapter
- System cables
- Module

For the online configurator, use the web code:

i Your web code: **#0007**

Simply enter “#0007” into the search field on our website.



Front adapters

- Tailored to controller-specific I/O modules
- Plug-in components
- Connection via system cables



8 and 32-channel modules

- Passive modules
- Relay modules
- Controller-specific layout
- Screw or Push-in connection technology



PLC-V8 adapters

- Connection of 8 channels via the “PLC series”
- Feasible functions: relay, solid-state relay or feed-through
- Individual function selection per channel
- Screw or Push-in connection technology

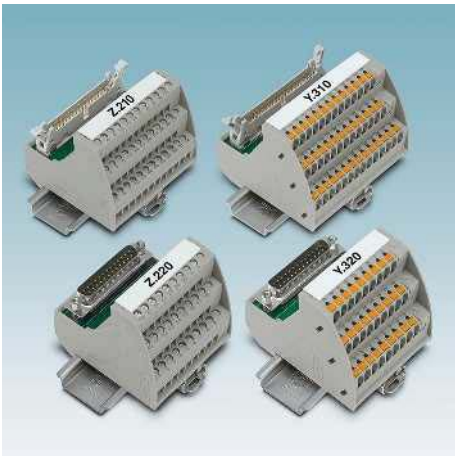

Universal modules

- Connector: IDC/FLK, D-SUB, or ELCO
- 1:1 connection
- Screw or Push-in connection technology
- Optional status indicator



Universal cables

- With IDC/FLK connector
- With D-SUB plug connector
- Optionally with open end



Potential distributors

- Up to 30 A / 250 V
- Two potential levels
- Screw or Push-in connection technology

System cabling for controllers

Product overview

Controller-specific system cabling

System component	Version	Controller									
		ABB	Allen Bradley		Emerson	Honeywell		Mitsubishi	OMRON CJ1	Phoenix Contact	
		S800 I/O	Control Logix	SLC 500	DeltaV	C300 Series CI/O, ML 200	PlantScape	MELSEC Q, L	CS1, CQM1, C200H	Axioline Inline	
		Page	Page	Page	Page	Page	Page	Page	Page	Page	
Front adapters		not required	470		not required	480	470	not required	not required	486	
System cables		Standard	570	536		566	570	536		536	
	Controller-specific	469		474	476	483		482	484		
Interface modules		Passive Standard	516	516	516	516	481	516	516	516	516
		Passive Controller-specific	468	489		477					
		Active Standard	524	524	524	524	524	524	524	524	524
		V8 adapter	530	530	530	530	530	530	530	530	530
	Relay/optocoupler	360	360	360	360	360	360	360	360	360	

Schneider		Siemens					Yokogawa		
TSX Quantum™	M340	S7 1500	S7 300	S7 400	ET 200SP HA	Conversion S5 to S7	CENTUM VP	ProSafe RS	
Page	Page	Page	Page	Page	Page	Page	Page	Page	Page
488	490	492	496	508		540	not required	not required	
536	536	536	536	536					
	491		504				514	514	
516	516	516	516	516					
489		492	506	506					
524	524	524	524	524					
530	530	530	530	530			530		
360	360	360	360	360			360		

Universal modules and cables

		Passive modules (connection technology)			
		IDC/FLK strips	D-SUB strips	ELCO strips	Potential distributors
Device series					
	Page	Page	Page	Page	
VIP Line		548	552 558	578	
Standard Line				560	
Feed-through modules			556		
Cables		562	570		

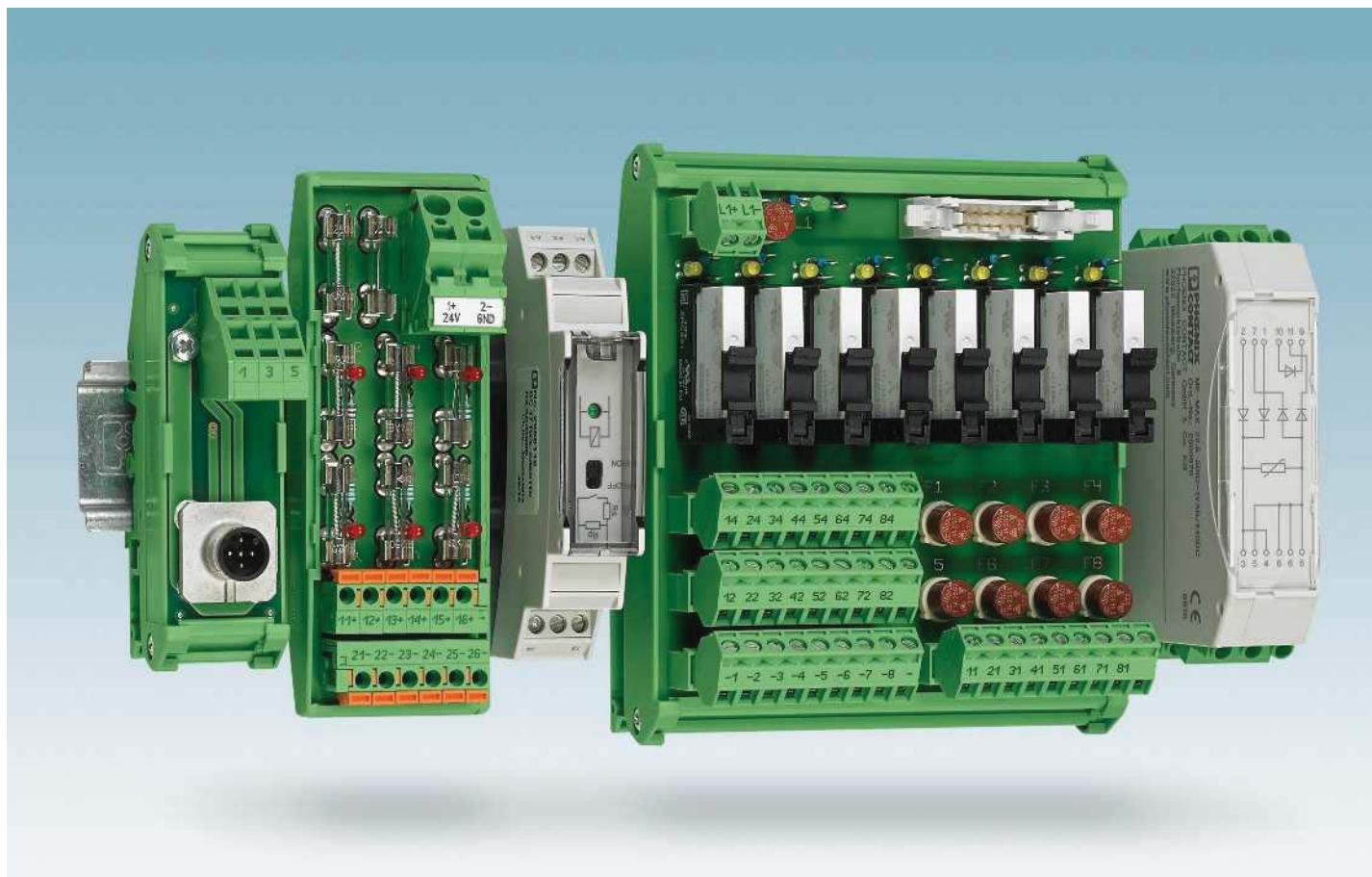

From the enquiry to the product

We develop your product from the idea to series production.

Concept phase

- Realization test in accordance with your specifications
- Personal consultation
- Tendering including draft drawing

Realization phase

- Development in accordance with product creation process
- Circuit diagram and PCB layout
- Component selection
- Creation of functional samples
- Creation of prototypes
- Tests in every phase of development
- EC conformance
- Preparation and implementation of approval procedures
- Environmental tests in accordance with standards
- Documentation

Series phase

- Production in accordance with IPC-A-610 Class 2
- 100% end test with automated test systems
- Lifecycle management

Directives and standards

- Low-voltage directive
- EMC directive
- IEC 60664-1
Insulation coordination for electrical equipment within low-voltage systems
- EN 50178
Electronic equipment for use in power installations
- EN 61000-6
Electromagnetic compatibility
- IPC A-600
Acceptance criteria for PCBs
- IPC-A-610
Acceptance criteria for electronic modules

Components used

We use connection technology and housings from the comprehensive Phoenix Contact portfolio.

Here you find all common market technologies:

- Screw and spring-cage connection
 - Push-in spring connection
 - Knife disconnection
 - Modular component housing
 - Building installation housings
 - Profile module carriers
- Furthermore, we use components, connectors, cables as well as PCBs from qualified and certified suppliers.

Product range

We create versions from catalog production for you or new products in accordance with your specifications from the following portfolio:

- Function modules such as diode gates
- Relay and optocoupler modules
- 1:1-Installation modules (connector on terminal block)
- Potential distributors
- System cables with high-pos. connectors
- System adapters for controllers and control systems
- Transfer modules for use between controller and field level
- Output modules with electrical isolation
- Module carrier for system cabling of signal conditioners or safe coupling relays

Your direct line to us

Do you have a specific question? Talk to us about it.



Simplified installation

- Objectives
 - Reduce assembly costs
 - Minimize installation time
 - Optimize space in the control cabinet
- Implementation
 - Analysis of the application
 - Draft of concept
- Result
 - Tailor-made solution from system components (standard and customer-specific)
 - Fault-free wiring

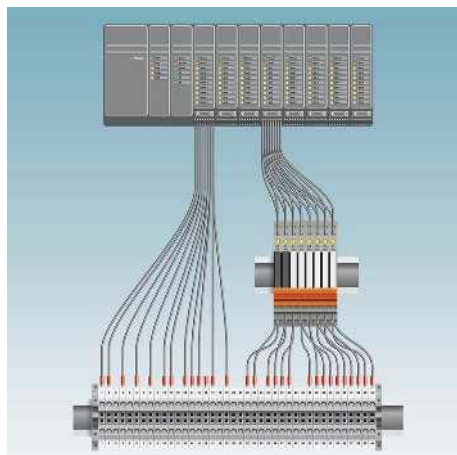

Retrofitting systems

- Task
 - Extension
 - Retrofitting
- Objectives
 - System availability
 - Fulfillment of statutory specifications
- Solution
 - Use adaptation solutions and high-pos. system cables
- Result
 - Minimum downtimes



Pre-assembled system cables

- With high-position connectors
 - D-SUB strips
 - IDC/FLK pin strips (2.54 mm)
- Pre-assembled at one or both ends
- Cables
 - Shielded, unshielded, halogen-free
 - 0.14 mm²/AWG 26 and 0.25 mm²/24 AWG
- Quality
 - Continuity and dielectric test
 - Other versions available on request



Installation modules

- 1:1-marshalling terminal block to high-pos. connector (D-SUB, HE10, ELCO...)
- Passive interface modules with system connection
- Potential distributors
- Fuse modules
- Diode modules
- Other modules on request



Relay and optocoupler modules

- With electromechanical relays
- With solid-state relays
- Multi-channel
- With system connection
- N/O contact or PDT contact
- LED status display
- Freewheeling diode
- Reverse polarity protection
- Redundant power supply



Termination Carrier module carriers

- The compact Termination Carrier connects
 - Signal conditioners
 - Signal conditioners for Ex i circuits
 - Signal conditioners for SIL applications
 - Safe coupling relays
- easily with the automation system via system cables.
- The advantages are clear:
 - Quick startup
 - Fault minimization

Controller-specific system cabling

ABB S800 I/O Termination boards with knife disconnection

The ABB S800 I/O system can be used to install the process wiring via D-SUB connectors. The ABB TU 812 Compact MTU is available for this purpose.

The FLKM-D25SUB/B/KDS3-MT/... modules are connected to the I/O modules via assembled D-SUB cables (see page 570).

In addition to screw connection with knife disconnection for every channel and ABB S800-specific labeling, the modules have the following features:

- Eight negative terminals with knife disconnection (TU810)
- Eight positive terminals with knife disconnection (TU810/P)
- For each channel, there is a positive and negative terminal with knife disconnection (TU830)

Passive interface modules can also be used for signal transmission (e.g., VIP-3/SC/D25SUB/F, 2315188), see page 553.

Web code for the online configurator

i Your web code: #0007

Connectable I/O modules

Card type	FLKM-D25SUB...		
	...TU810	...TU810/P	...TU830
Digital input	DI 814	DI 810 DI 811 DI 818 DI 830 DI 831 DI 840 DI 885	DI 810 DI 811 DI 814 DI 818 DI 830 DI 831 DI 840 DI 885
Digital output	DO 810 DO 818 DO 840	DO 814	DO 810 DO 814 DO 818 DO 840
Analog input	AI 810 AI 815 AI 820 AI 830 AI 835 AI 845	AI 810 AI 815	AI 810 AI 815 AI 815 AI 830 AI 835 AI 845
Analog output	AO 810 AO 815 AO 820 AO 845		AO 810 AO 815 AO 820 AO 845
Other	DP 820		DP 820



Explanation:
 IDC/FLK strip
 Connection to I/O card
 Screw terminal blocks for separate supply

Maximum permissible operating voltage
 Maximum permissible current (per branch)
 Maximum total current (voltage supply)

Ambient temperature (operation)
 Mounting position
 Standards/regulations
 Connection method

Connection data solid/stranded/AWG
 Dimensions

Field level
 Controller level

H / D

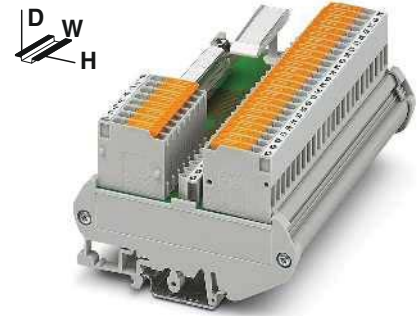

Interface module
with knife disconnect terminal blocks

ERIC

Technical data

25 V AC / 60 V DC
 2 A
 4 A (8 A L1-/L2-)

-20°C ... 50°C
 any
 DIN EN 50178, IEC 60664
 Screw connection with disconnect knife
 D-SUB socket strip
 0.2 ... 4 mm² / 0.2 ... 2.5 mm² / 24 - 12
 90 mm / 61 mm

Ordering data

Type	Order No.	Pcs./Pkt.
FLKM-D25 SUB/B/KDS3-MT/TU810	2304513	1
FLKM-D25 SUB/B/KDS3-MT/TU810/P	2304539	1
FLKM-D25 SUB/B/KDS3-MT/TU830	2304526	1

Description	No. of pos.	Module width W
VARIOFACE module , with knife disconnect terminal blocks in ABB-specific marking: - with 8 negative terminal blocks	25	126.5 mm
- with 8 positive terminal blocks	25	126.5 mm
- each with 16 positive and negative terminal blocks	25	247.5 mm

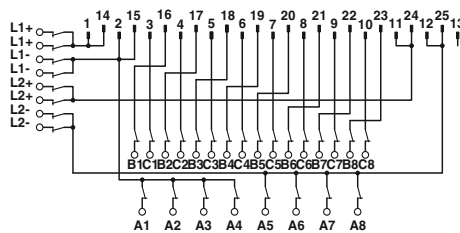

FLKM-D25 SUB/B/KDS3-MT/TU810 connection scheme

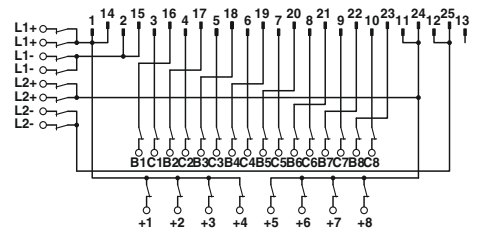

FLKM-D25 SUB/B/KDS3-MT/TU810/P connection scheme

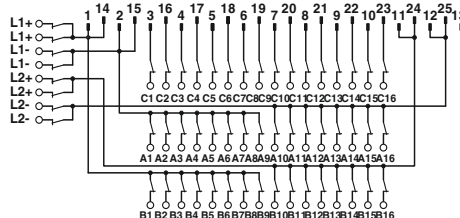

FLKM-D25 SUB/B/KDS3-MT/TU830 connection scheme

ABB S800 I/O System cables

The ABB S800 I/O system can be used to install the process wiring via D-SUB connectors. The ABB TU 812 Compact MTU is available for this purpose.

The CABLE-D25SUB/B/2X14/.../TU812 system cables convert digital signals from a D-SUB socket strip to two IDC/FLK socket strips. Therefore, all 8-channel termination boards of the system cabling are connected to S800 I/O modules. Two termination boards are used per module.

Notes:

Digital modules such as VIP-2/SC/FLK14/PLC (2315214) can be found starting on page 516

Relay connections using PLC-V8/FLK14/OUT (2295554) and the like can be found starting on page 427



System cable



Technical data

Maximum permissible operating voltage	25 V AC / 60 V DC
Maximum permissible operating voltage UL / CSA	125 V / -
Maximum permissible current carrying capacity per path	1 A
Ambient temperature (operation)	-20°C ... 50°C
Assembly	Insulation displacement, IEC 60352-4/DIN EN 60352-4
Conductor cross section	AWG 26 / 0.14 mm ²
Conductor structure: stranded wires / material	7 / Cu tin-plated
Outside diameter	6.3 mm

25 -position

Ordering data

Description	No. of pos.	Cable length	Type	Order No.	Pcs./Pkt.
VARIOFACE system cable , for S800 I/O, with a 25-pos. D-SUB socket strip and two 14-pos. IDC/FLK socket strips, in standard lengths					
	25	1 m	CABLE-D25SUB/B/2X14/100/TU812	2304649	1
	25	2 m	CABLE-D25SUB/B/2X14/200/TU812	2304652	1
	25	3 m	CABLE-D25SUB/B/2X14/300/TU812	2304665	1
	25	5 m	CABLE-D25SUB/B/2X14/500/TU812	2304678	1
VARIOFACE system cable , for S800 I/O, with a 25-pos. D-SUB socket strip and two 14-pos. IDC/FLK socket strips, in variable lengths					
	25		CABLE-D25SUB/B/2X14/TU812/...	2304681	1

Connectable I/O modules

Card type	CABLE-D25SUB/B/2X14/.../TU812
Digital input	DI 810 DI 811 DI 814 DI 818 DI 830 DI 831 DI 840 DI 885
Digital output	DO 810 DO 814 DO 818 DO 840

Color code and pin assignment CABLE-D25SUB/B/2X14...TU812

D-SUB connector 25-pos.	FLK 14 1st connector	FLK 14 2nd connector	Wire color
1	9		Gray
2	10		White
3	1		Black
4	3		Red
5	5		Yellow
6	7		Blue
7		1	Black
8		3	Red
9		5	Yellow
10		7	Blue
11		9	Orange
12		10	White
13	NC	NC	-
14	11		White-black
15	12		White-brown
16	2		Brown
17	4		Orange
18	6		Green
19	8		Violet
20		2	Brown
21		4	Orange
22		6	Green
23		8	Violet
24		11	White-black
25		12	White-brown

Ordering example for system cable:

- Cable for ABB S800, 12.75 m long

Quantity	Order No.	Length [m] ¹⁾
1	2304681	12.75

¹⁾ min. 0.20 m

System cabling for controllers

Controller-specific system cabling

Allen Bradley ControlLogix, Honeywell PlantScape Front adapters

I/O modules with 32 channels or of this type

The front adapters are pushed into the tall 1756-TBE covers (not supplied as standard, original accessories must be ordered directly from manufacturer) of the controller. A 50-pos. system cable can connect a maximum of 32 channels to the field level.

Perfectly-fitting VARIOFACE termination boards round off this system concept.

Web code for the online configurator

i Your web code: **#0007**

Notes:
Front adapters can also be used without cover.
Controller-specific modules from page 472
Digital modules such as VIP-2/SC/FLK14/PLC (2315214) can be found starting on page 516
For system cables, see page 536
Relay connections using PLC-V8/FLK14/OUT (2295554) and the like can be found starting on page 427



**32-channel front adapter
with 50-pos. FLK strip**



Technical data

Maximum permissible operating voltage
Maximum permissible operating voltage UL / CSA

25 V AC / 60 V DC
125 V / -

Maximum permissible current

1 A (per path)
8 A (per connection, supply via separate power supply)

Ambient temperature (operation)
Ambient temperature (storage/transport)
Connection data solid/stranded/AWG
Standards/regulations

-20°C ... 50°C
-20°C ... 70°C
0.14 ... 1.5 mm² / 0.14 ... 1.5 mm² / 28 - 16
DIN EN 50178 / IEC 60664

Ordering data

Description	No. of pos.
VARIOFACE front adapter , for ControlLogix:	
- A maximum of 1 x 32 channels can be connected	50
- IB 32 input board	50

Type	Order No.	Pcs./Pkt.
FLKM 50-PA-AB/1756/EXTC	2302735	1
FLKM 50-PA-AB/1756/IN/EXTC	2302748	1

Front adapters for I/O modules of the Allen®Bradley ControlLogix and Honeywell PlantScape automation devices

Card type	FLKM 50-PA-AB/1756/EXTC
Digital input	1756-IB 16 D* or TC-IDX 161* 1756-IB 16 I* or TC-IDJ 161* 1756-IH 16 I*
Digital output	1756-OB 32 or TC-ODD 321
Analog input	1756-IF 8* 1756-IF 16 I* or TC-IAH 161* 1756-IF 8H* or TC-HAI 081*
Counter	1756-HSC*
Servo	1756-M02 AE*

Card type	FLKM 50-PA-AB/1756/IN/EXTC
Digital input	1756-IB 32 or TC-IDD 321

* Only in conjunction with
VIP-2/SC/FLK50/AB-1756, Order No.: [2322317](#)
VIP-2/PT/FLK50/AB-1756, Order No.: [2904286](#)
There must be no voltage supply at the front adapter.
Risk of short circuit!

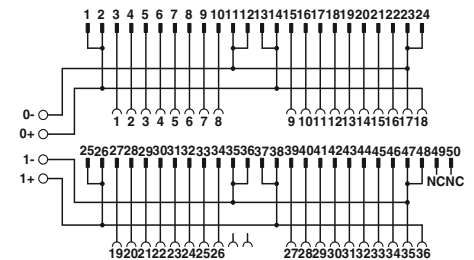

Connection scheme FLKM 50-PA-AB/1756/EXTC

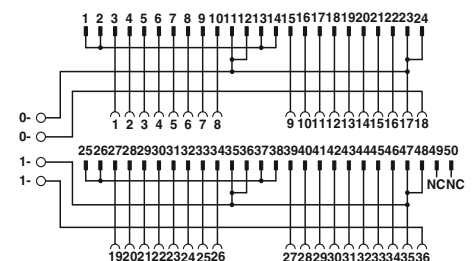

Connection scheme FLKM 50-PA-AB/1756/IN/EXTC

Explanation:

- IDC/FLK strip
- Connection to I/O card
- Screw terminal blocks for separate supply

Allen Bradley ControlLogix, Honeywell PlantScape Front adapter

I/O modules with 16 channels or of this type

The front adapters are pushed into the tall 1756-TBE covers (not supplied as standard, original accessories must be ordered directly from manufacturer) of the controller. Two 14-pos. system cables are used to connect up to 2 x 8 channels to the field level.

Perfectly-fitting VARIOFACE termination boards round off this system concept.

Web code for the online configurator

i Your web code: #0007

Notes:

Front adapters can also be used without cover.

Controller-specific modules from page 473

Digital modules such as VIP-2/SC/FLK14/PLC (2315214) can be found starting on page 516

For system cables, see page 536

Relay connections using PLC-V8/FLK14/OUT (2295554) and the like can be found starting on page 427



16-channel front adapter
with two 14-pos. FLK strips



Technical data

Maximum permissible operating voltage
Maximum permissible operating voltage UL / CSA

25 V AC / 60 V DC
125 V / -

Maximum permissible current

1 A (per path)
8 A (per connection, supply via separate power supply)

Ambient temperature (operation)
Ambient temperature (storage/transport)
Connection data solid/stranded/AWG
Standards/regulations

-20°C ... 50°C
-20°C ... 70°C
0.14 ... 1.5 mm² / 0.14 ... 1.5 mm² / 28 - 16
DIN EN 50178 / IEC 60664

Ordering data

Description No. of pos.

VARIOFACE front adapter, for ControlLogix:

- Up to 2 x 8 channels can be connected 14
- IA 16, IB 16, IC 16, IN 16 input card 14

Type	Order No.	Pcs./Pkt.
FLKM 14-PA-AB/1756/EXTC	2302861	1
FLKM 14-PA-AB/1756/IN/EXTC	2302874	1

Front adapters for I/O modules of the
Allen Bradley ControlLogix and Honeywell PlantScape
automation devices

Card type	FLKM 14-PA-AB/1756/EXTC
Digital output	1756-OB 16 E
Analog input	1756-IF 6 CIS** 1756-IF 6 I** or TC-IAH 061** 1756-IR 6 I** or TC-IXR 061** 1756-IT 6 I** or TC-IXL 061**
Analog output	1756-OF 4 I** 1756-OF 6 CI** or TC-OAH 061** 1756-OF 6 VI** or TC-OAV 061** 1756-OF 8** or TC-OAV 081** 1756-OF 8 H**
Switch	1756-PLS**

Card type	FLKM 14-PA-AB/1756/IN/EXTC
Digital input	1756-IN 16** 1756-IA 16 or TC-IDA 161** 1756-IB 16 1756-IC 16**

** Only in conjunction with
VIP-2/SC/2FLK14/AB-1756, Order No.: 2322333
VIP-2/PT/2FLK14/AB-1756, Order No.: 2904288
There must be no voltage supply at the front adapter.
Risk of short circuit!

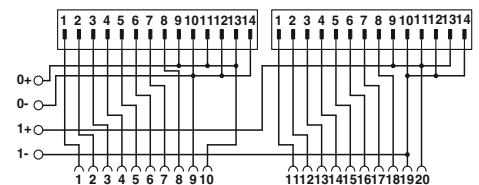

Connection scheme FLKM 14-PA-AB/1756/EXTC

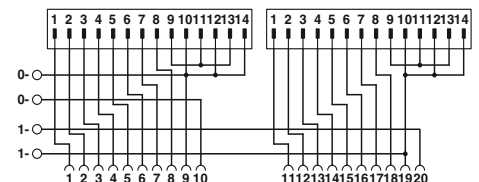

Connection scheme FLKM 14-PA-AB/1756/IN/EXTC

Explanation:

- IDC/FLK strip
- Connection to I/O card
- Screw terminal blocks for separate supply

System cabling for controllers

Controller-specific system cabling

Allen Bradley ControlLogix VIP interface modules

These VIP – VARIOFACE Professional modules are used in combination with 50-pos. system cables and the relevant front adapters.

Features:

- Numerical marking (1-36)
- Specially for ControlLogix

Notes:
For marking systems (e.g., "ZB 22:UNBEDRUCKT"; Order No. 0811862) and mounting material, see Catalog 3.

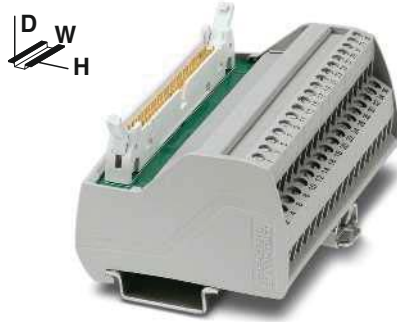

Passive termination board for Allen Bradley ControlLogix with screw connection



Maximum permissible operating voltage	25 V AC / 60 V DC
Maximum permissible operating voltage UL / CSA	125 V / -
Maximum permissible current (per branch)	1 A
Ambient temperature (operation)	-20°C ... 50°C
Mounting position	any
Standards/regulations	IEC 60664, DIN EN 50178
Connection method	Screw connection
	Field level
	Controller level
Connection data solid/stranded/AWG	IDC/FLK pin strip
Dimensions	0.2 ... 4 mm ² / 0.2 ... 2.5 mm ² / 24 - 12 65.5 mm / 56 mm
	H / D

Technical data

Description	No. of pos.	Module width W
VARIOFACE interface module, with ControlLogix-specific marking from 1 to 36		
- with screw connection	50	95.9 mm
- with Push-in connection	50	97.7 mm

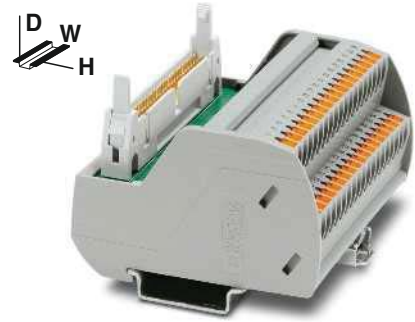

Passive termination board for Allen Bradley ControlLogix with Push-in connection



Maximum permissible operating voltage	25 V AC / 60 V DC
Maximum permissible operating voltage UL / CSA	125 V / 125 V
Maximum permissible current (per branch)	1 A
Ambient temperature (operation)	-20°C ... 50°C
Mounting position	any
Standards/regulations	IEC 60664, DIN EN 50178
Connection method	Push-in connection
	Field level
	Controller level
Connection data solid/stranded/AWG	IDC/FLK pin strip
Dimensions	0.14 ... 1.5 mm ² / 0.14 ... 1.5 mm ² / 26 - 14 72.1 mm / 56 mm

Technical data

Type	Order No.	Pcs./Pkt.
VIP-2/SC/FLK50/AB-1756	2322317	1

Ordering data

Ordering data

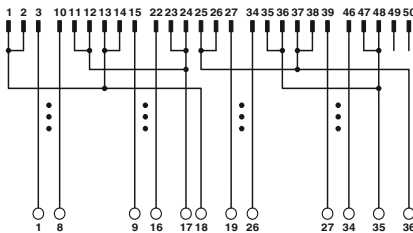

Connection scheme VIP-2/.../FLK50/AB-1756

Allen Bradley ControlLogix VIP interface modules

These VIP – VARIOFACE Professional modules are used in combination with two 14-pos. system cables and the relevant front adapters for Allen Bradley.

Features:

- Numerical marking (1-20)
- Specially for ControlLogix

Notes:
For marking systems (e.g., "ZB 22:UNBEDRUCKT"; Order No. 0811962) and mounting material, see Catalog 3.

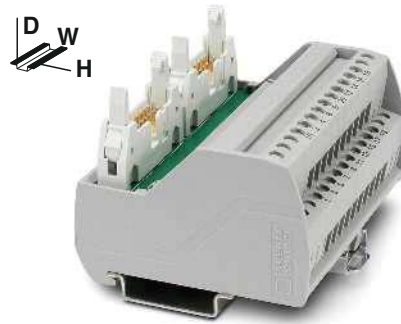

Passive termination board for Allen Bradley ControlLogix with screw connection

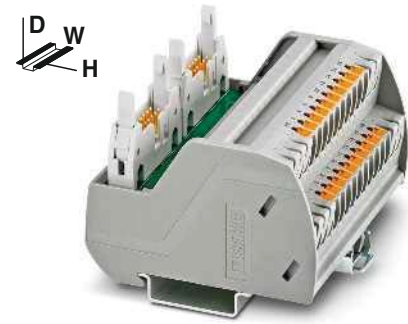

Passive termination board for Allen Bradley ControlLogix with Push-in connection



Technical data

Maximum permissible operating voltage	25 V AC / 60 V DC
Maximum permissible operating voltage UL / CSA	125 V / -
Maximum permissible current (per branch)	1 A
Ambient temperature (operation)	-20°C ... 50°C
Mounting position	any
Standards/regulations	IEC 60664, DIN EN 50178
Connection method	Screw connection
	Field level
	Controller level
Connection data solid/stranded/AWG	IDC/FLK pin strip
Dimensions	0.2 ... 4 mm ² / 0.2 ... 2.5 mm ² / 24 - 12 65.5 mm / 56 mm

Technical data

Maximum permissible operating voltage	25 V AC / 60 V DC
Maximum permissible operating voltage UL / CSA	125 V / 125 V
Maximum permissible current (per branch)	1 A
Ambient temperature (operation)	-20°C ... 50°C
Mounting position	any
Standards/regulations	IEC 60664, DIN EN 50178
Connection method	Push-in connection
	Field level
	Controller level
Connection data solid/stranded/AWG	IDC/FLK pin strip
Dimensions	0.14 ... 2.5 mm ² / 0.14 ... 2.5 mm ² / 26 - 14 72.1 mm / 56 mm

Ordering data

Description	No. of pos.	Module width W
VARIOFACE interface module, with ControlLogix-specific marking from 1 to 20		
- with screw connection	14	80.6 mm
- with Push-in connection	14	82.5 mm

Type	Order No.	Pcs./Pkt.
VIP-2/SC/2FLK14/AB-1756	2322333	1

Ordering data

Type	Order No.	Pcs./Pkt.
VIP-2/PT/2FLK14/AB-1756	2904288	1

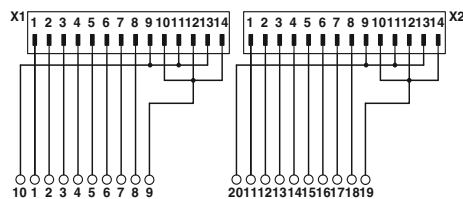

Connection scheme VIP-2/.../2FLK14/AB-1756

System cabling for controllers

Controller-specific system cabling

Allen Bradley SLC 500 System cables for 32 channels

The 32-channel I/O cards of the SLC 500 are connected using 40-pos. connectors (already integrated into the I/O modules). Passive interface modules (-3/SC/FLK40, etc.) are connected to the I/O cards using the **FLK 40/EZ-DR/.../SLC** system cables.

Web code for the online configurator

i Your web code: **#0007**

Notes:

Digital modules such as VIP-3/SC/FLK40 (2315078) can be found starting on page 548

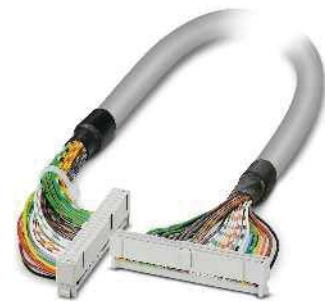

**System cable for 32-channel I/O cards
of the SLC 500
(OB32, OV32, IB32, IV32)**



Technical data

Maximum permissible operating voltage	25 V AC / 60 V DC
Maximum permissible operating voltage UL / CSA	125 V / -
Maximum permissible current carrying capacity per path	1 A
Ambient temperature (operation)	-20°C ... 50°C
Assembly	Insulation displacement, IEC 60352-4/DIN EN 60352-4
Conductor cross section	AWG 26 / 0.14 mm ²
Conductor structure: stranded wires / material	7 / Cu tin-plated
Outside diameter	10 mm
	40 -position

Ordering data

Description	No. of pos.	Cable length	Type	Order No.	Pcs./Pkt.
Assembled round cable , with two 40-pos. IDC/FLK socket strips in fixed lengths (50 cm steps) for connection to 32-channel I/O cards of the SLC 500					
	40	0.5 m	FLK 40/EZ-DR/ 50/SLC	2294610	1
	40	1 m	FLK 40/EZ-DR/ 100/SLC	2294623	1
	40	1.5 m	FLK 40/EZ-DR/ 150/SLC	2294636	1
	40	2 m	FLK 40/EZ-DR/ 200/SLC	2294649	1
	40	3 m	FLK 40/EZ-DR/ 300/SLC	2294652	1

Allen Bradley SLC 500
System cables for 32 channels

The 32-channel I/O cards of the SLC 500 are connected through 40-pos. connectors (already integrated on the I/O modules). 32 channels are split into 4x8 channels using the FLK 40/4X14/EZ-DR/... system cables.

The following 8-channel system cabling modules can be coupled:

- OB32 and IB32
passive and active modules plus V8 adapter
- OV32 and IV32
passive modules without status indicator

Web code for the online configurator

i Your web code: #0007

Notes:
Digital modules such as VIP-2/SC/FLK14/PLC (2315214) can be found starting on page 516
Relay connections using PLC-V8/FLK14/OUT (2295554) and the like can be found starting on page 427



System cable for splitting max. 32 channels into 4 x 8 channels (OB32, IB32)



Technical data	
Maximum permissible operating voltage	25 V AC / 60 V DC
Maximum permissible operating voltage UL / CSA	125 V / -
Maximum permissible current carrying capacity per path	1 A
Ambient temperature (operation)	-20°C ... 50°C
Assembly	Insulation displacement, IEC 60352-4/DIN EN 60352-4
Conductor cross section	AWG 26 / 0.14 mm ²
Conductor structure: stranded wires / material	7 / Cu tin-plated
Outside diameter	7.8 mm

Ordering data					
Description	No. of pos.	Cable length	Type	Order No.	Pcs./Pkt.
Assembled round cable , for connection to Allen Bradley SLC500, OB32, and IB32, with a 40-pos. IDC/FLK socket strip and four 14-pos. IDC/FLK socket strips, for splitting max. 32 channels into 4 x 8 channels.					
for OB32	40	0.5 m	FLK 40/4X14/EZ-DR/ 50/OB32	2296786	1
	40	1 m	FLK 40/4X14/EZ-DR/ 100/OB32	2298483	1
	40	2 m	FLK 40/4X14/EZ-DR/ 200/OB32	2298522	1
	40	3 m	FLK 40/4X14/EZ-DR/ 300/OB32	2298535	1
for IB32	40	0.5 m	FLK 40/4X14/EZ-DR/ 50/IB32	2296812	1
	40	1 m	FLK 40/4X14/EZ-DR/ 100/IB32	2296825	1
	40	2 m	FLK 40/4X14/EZ-DR/ 200/IB32	2296838	1
	40	3 m	FLK 40/4X14/EZ-DR/ 300/IB32	2296841	1

Controller-specific system cabling

Emerson DeltaV System cables

The DeltaV system can be used to install the process wiring via “mass termination blocks” (MTBs) using IDC/FLK connectors. In addition to the 10, 16, and 20-pos. system cables of system cabling (see page 536), the following system-specific cables are available:

- **FLK 16/14/DV-OUT/...**, for digital assemblies with 16-pos. MTB for connection with PLC-INTERFACE
- **FLK 16/14/DV-IN/...**, for digital modules with 16-pos. MTB for connection to PLC-INTERFACE
- **FLK 20/2FLK14/EZ-DR/...**, for digital assemblies with 40-pos. MTB for connection with PLC-INTERFACE
- **FLK 16/24/DV-AI/EZ-DR/...**, for analog assemblies with 24-pos. MTB
- **FLK 50/2FLK20/EZ-DR/.../DV** system cables are specifically designed for 32-channel I/O modules with 40-pin MTB for the purpose of connecting I/O modules with 32-channel VARIOFACE interface modules



System cable for DeltaV



Technical data

Maximum permissible operating voltage	25 V AC / 60 V DC	
Maximum permissible operating voltage UL / CSA	125 V / -	
Maximum permissible current carrying capacity per path	1 A	
Maximum conductor resistance	0.16 Ω/m	
Ambient temperature (operation)	-20°C ... 50°C	
Conductor cross section	AWG 26 / 0.14 mm ²	
Outside diameter		
	16 -position	6.8 mm
	20 -position	7.6 mm
	24 -position	6.5 mm
	20 -position	10.3 mm

Ordering data

Description	No. of pos.	Cable length	Type	Order No.	Pcs./Pkt.
System cable , for 16-pos. “mass termination blocks” with a 16-pos. and a 14-pos. IDC/FLK socket strip for connection with PLC-INTERFACE					
	16	0.3 m	FLK 16/14/DV-OUT/ 30	2304348	1
	16	0.5 m	FLK 16/14/DV-OUT/ 50	2304351	1
	16	1 m	FLK 16/14/DV-OUT/100	2300575	1
	16	2 m	FLK 16/14/DV-OUT/200	2300588	1
	16	3 m	FLK 16/14/DV-OUT/300	2304364	1
Variable cable length	16		FLK 16-14-DV-OUT/...	2304377	1
System cable , for 16-pos. “mass termination blocks” with a 16-pos. and a 14-pos. IDC/FLK socket strip for connection with PLC-INTERFACE					
	16	0.5 m	FLK 16/14/DV-IN/ 50	2304393	1
	16	1 m	FLK 16/14/DV-IN/100	2300559	1
	16	2 m	FLK 16/14/DV-IN/200	2300562	1
	16	3 m	FLK 16/14/DV-IN/300	2304403	1
	16	4 m	FLK 16/14/DV-IN/400	2305185	1
Variable cable length	16		FLK 16-14-DV-IN/...	2304416	1
System cable , for 40-pos. (2 x 20) “mass termination blocks” with a 20-pos. and two 14-pos. IDC/FLK socket strips for connection with PLC-INTERFACE (two cables should be used per 32-channel I/O card)					
	20	1 m	FLK 20/2FLK14/EZ-DR/100/KONFEK	2298470	1
	20	2 m	FLK 20/2FLK14/EZ-DR/200/KONFEK	2298438	1
	20	3 m	FLK 20/2FLK14/EZ-DR/300/KONFEK	2300818	1
Variable cable length	20		FLK 20/2FLK14/EZ-DR/...	2304487	1
System cable , for 24-pos. “mass termination blocks” with a 24-pos. and a 16-pos. IDC/FLK socket strip for connection with UM-DELTA/... modules					
	24	0.3 m	FLK 16/24/DV-AI/EZ-DR/ 30	2304319	1
	24	0.5 m	FLK 16/24/DV-AI/EZ-DR/ 50	2304296	1
	24	1 m	FLK 16/24/DV-AI/EZ-DR/100	2301134	1
	24	2 m	FLK 16/24/DV-AI/EZ-DR/200	2301545	1
	24	3 m	FLK 16/24/DV-AI/EZ-DR/300	2304322	1
Variable cable length	24		FLK 16-24-DV-AI-EZ-DR/...	2304335	1
System cable , for 40-pos. “mass termination blocks” with two 20-pos. and one 50-pos. flat-ribbon cable plugs for connecting with 32-channel interface modules					
	20	0.5 m	FLK 50/2FLK20/EZ-DR/ 50/DV	2304872	1
	20	1 m	FLK 50/2FLK20/EZ-DR/ 100/DV	2304898	1
	20	2 m	FLK 50/2FLK20/EZ-DR/ 200/DV	2304908	1
	20	3 m	FLK 50/2FLK20/EZ-DR/ 300/DV	2304911	1
	20	6 m	FLK 50/2FLK20/EZ-DR/ 600/DV	2304937	1
	20	8 m	FLK 50/2FLK20/EZ-DR/ 800/DV	2304940	1
	20	10 m	FLK 50/2FLK20/EZ-DR/1000/DV	2304953	1
Variable cable length	20		FLK 50-2FLK20-EZ-DR-DV/...	2304966	1



Emerson DeltaV Controller boards for eight channels

These system-specific termination boards for DeltaV modules are used in combination with the relevant system cables. They are connected to 8-channel modules via “mass termination blocks” with IDC/FLK connection.

FLKM 16/DV

- Universal module
- 1:1 connection

FLKM 16/AI/DV

- 1:1 connection
- Separate equipotential terminals per channel

FLKM 16/AO/SI/DV

- 1:1 connection
- 5 x 20, 50 mA T, IEC 60127-2/3 fuse per channel

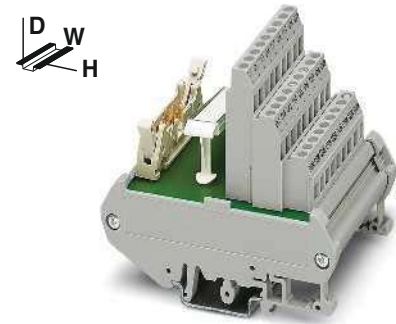

Interface module for 8 channels

ERC

Technical data

FLKM 16/.../DV	FLKM 16/.../SI/.../DV
25 V AC / 60 V DC	25 V AC / 60 V DC
1 A (per signal path)	50 mA (in delivered state, with one 50 mA fuse, max. 1 A permitted)
-20°C ... 50°C	-20°C ... 50°C
Any	Any
DIN EN 50178, IEC 60664	
Screw connection	Screw connection
IDC/FLK pin strip	IDC/FLK pin strip
0.2 ... 4 mm ² / 0.2 ... 2.5 mm ² / 24 - 12	
90 mm / 68 mm	

Ordering data

Type	Order No.	Pcs./Pkt.
FLKM 16/DV	2304432	1
FLKM 16/AI/DV	2304429	1
FLKM 16/AO/SI/DV	2304445	1

Maximum permissible operating voltage
Maximum permissible current (per branch)

Ambient temperature (operation)
Mounting position
Standards/regulations
Connection method

Field level
Controller level

Connection data solid/stranded/AWG
Dimensions

H / D

Description	No. of pos.	Module width W
Interface module, with 1:1 connection	16	45 mm
Interface module, with 1:1 connection and separate potential terminal blocks per channel	16	57 mm
Interface module, with fuses per channel	16	90 mm

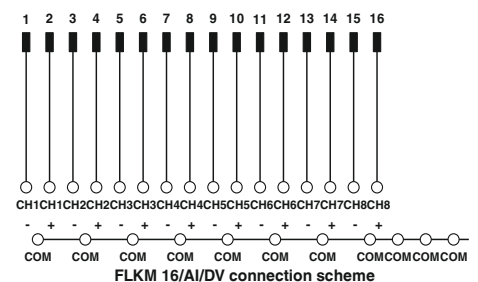
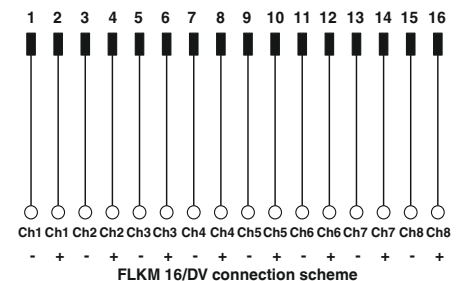
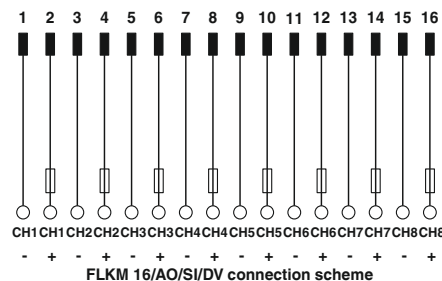

Controller-specific system cabling

Emerson DeltaV

Controller boards for 32 channels

These system-specific termination boards for DeltaV modules are used in combination with FLK 50/2FLK20/EZ-DR.../DV system cables. They are connected to 32-channel modules via 40-pos. "mass termination blocks" with IDC/FLK connection.

FLKM 50/32M/DV

- Can be used for 32-channel input and output cards
- Two-conductor connection with a separate negative terminal per channel

FLKM 50/32M/IN/LA/DV

- Can be used for 32-channel input modules
- LED status display per channel
- Two-conductor connection with a separate negative terminal per channel (Dry Contact)

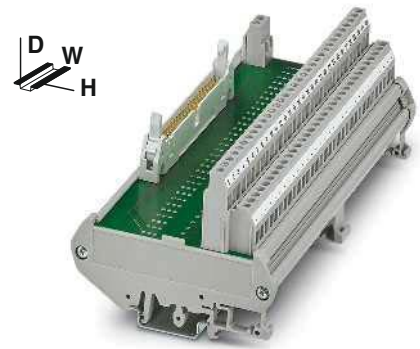

**Termination board for DeltaV
With 2-conductor screw connection**

ERIC

Technical data

FLKM 50/32M/DV	FLKM 50/32M/IN/LA/DV
25 V AC / 60 V DC	30 V DC
1 A	1 A
-20°C ... 50°C	-20°C ... 50°C
any	any
DIN EN 50178, IEC 60664	
Screw connection	Screw connection
IDC/FLK pin strip	IDC/FLK pin strip
0.2 ... 4 mm ² / 0.2 ... 2.5 mm ² / 24 - 12	
90 mm / 68 mm	

Ordering data

Type	Order No.	Pcs./Pkt.
FLKM 50/32M/DV	2304869	1
FLKM 50/32M/IN/LA/DV	2304856	1

Maximum permissible operating voltage	
Maximum permissible current (per branch)	
Ambient temperature (operation)	
Mounting position	
Standards/regulations	
Connection method	Field level
	Controller level
Connection data solid/stranded/AWG	
Dimensions	H / D

Description	No. of pos.	Module width W
VARIOFACE interface modules, for 32-channel I/O modules:		
- Input/Output	50	169 mm
- Input with LED per signal	50	169 mm

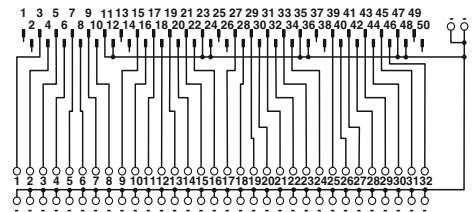

Connection scheme FLKM 50/32M/DV

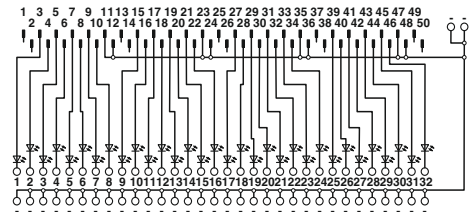

Connection scheme FLKM 50/32M/IN/LA/DV

Emerson DeltaV VIP controller board with fuses for 8 channels

System-specific interface module for use in combination with the respective system cables. The controller board is connected to 8-channel modules through 16-position “mass termination blocks” with flat ribbon cable connection.

Features:

- Fuse per channel
- Separate equipotential terminals per channel
- Knife disconnection for each channel
- Push-in connection

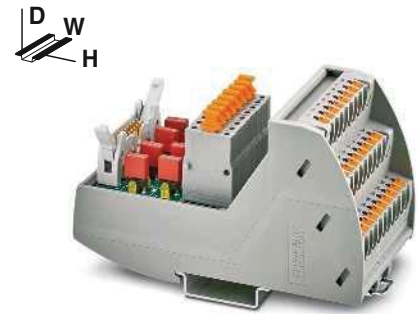

**Fuse module for DeltaV for 8 channels
With Push-in connection**



Technical data

Maximum permissible operating voltage	24 V DC
Maximum permissible operating voltage UL / CSA	24 V / 24 V
Maximum permissible current (per branch)	63 mA (in as supplied state, with one 63 mA fuse)
Ambient temperature (operation)	-20°C ... 60°C
Mounting position	any
Standards/regulations	DIN EN 50178
Connection method	Field level Controller level
Connection data solid/stranded/AWG	Push-in connection IDC/FLK pin strip
Dimensions	0.14 ... 2.5 mm ² / 0.14 ... 2.5 mm ² / 26 - 14 109.8 mm / 63 mm

Ordering data

Description	No. of pos.	Module width W	Type	Order No.	Pcs./Pkt.
VARIOFACE termination board, for 8-channel modules	16	57.1 mm	VIP-PT/FLK16/DS/FU/LED/AN/DV	2903599	1

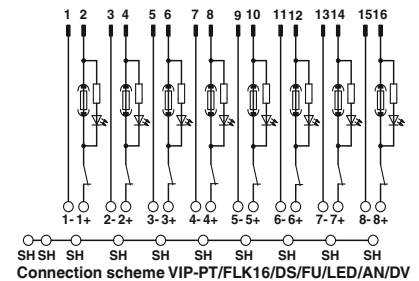

System cabling for controllers

Controller-specific system cabling

Honeywell C300, Series C I/O Front adapters

The front adapters mean that pre-assembled system cables can be directly connected to I/O modules.

FLKM-PA-D37/HW/DIO/C300

- Front adapter with D-SUB connector
- Connection of a maximum of 16 digital channels
- Specifically for digital I/O cards

FLKM-PA-D37/HW/AN/C300

- Front adapter with D-SUB connector
- Connection of analog modules

FLKM-PA-2D15/HW/.../C300

- Front adapter with two 15-pos. D-SUB connectors
- Connection of a maximum of 2 x 8 digital inputs/outputs per adapter
- Specifically for connecting PLC-V8/D15.../OUT or PLC-V8/D15.../IN

Web code for the online configurator

i Your web code: **#0007**

Notes:

Matching system cable fitted with D-SUB female connector at both ends, see page 571

¹⁾ No UL approval



Honeywell C300 front adapter



Technical data

Maximum permissible operating voltage	60 V DC
Maximum permissible operating voltage UL / CSA	125 V / -
Maximum permissible current	1 A (per path)
Ambient temperature (operation)	-20°C ... 50°C
Ambient temperature (storage/transport)	-20°C ... 70°C
Mounting position	Any
Standards/regulations	IEC 60664 / DIN EN 50178

Ordering data

Description	No. of pos.	Type	Order No.	Pcs./Pkt.
VARIOFACE front adapter for C I/O series, with one D-SUB pin strip				
- For digital I/O modules	37	FLKM-PA-D37/HW/DIO/C300	2901423	1
- For analog I/O modules	37	FLKM-PA-D37/HW/AN/C300	2900622	1
VARIOFACE front adapter for C I/O series, with two D-SUB pin strips				
- For digital output modules	15	FLKM-PA-2D15/HW/DO/C300¹⁾	2900924	1
- For digital input modules	15	FLKM-PA-2D15/HW/DI/C300¹⁾	2901879	1

Front adapters for I/O modules of the C300 and C I/O series

Card type	FLKM-PA-D37/HW/DIO/C300
Digital input	TDIL 11* TDIL 01*
Digital output	TDOB 11* TDOB 01*

Card type	FLKM-PA-D37/HW/AN/C300
Analog input	TAIX 01** TAIX 11**
Analog output	TAOX 01** TAOX 11**

Card type	FLKM-PA-2D15/HW/DO/C300
Digital output	TDOB 01* TDOB 11*

Card type	FLKM-PA-2D15/HW/DI/C300
Digital input	TDIL 01* TDIL 11*

* Two front adapters are required for each module.

** For three-conductor operation (channels 13 - 16) of input modules: only in conjunction with
VIP-3/SC/D37SUB/M/HW/C300, Order No.: [2900675](#)
VIP-3/PT/D37SUB/M/HW/C300, Order No.: [2904276](#)

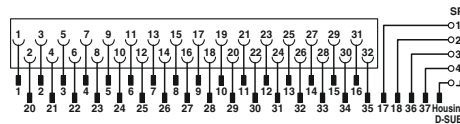

Connection scheme FLKM-PA-D37/HW/AN/C300

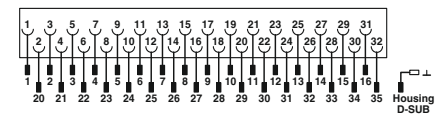

Connection scheme: FLKM-PA-D37/HW/DIO/C300

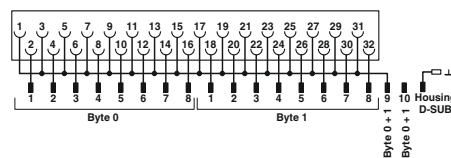

Connection scheme FLKM-PA-2D15/HW/DI/C300

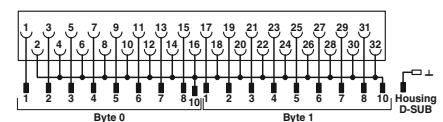

Connection scheme: FLKM-PA-2D15/HW/DO/C300

Explanation:

- Connectors
- Connection to I/O card
- Screw terminal blocks for separate supply

Honeywell C300, Series C I/O Interface modules

These VIP – VARIOFACE Professional modules are used in combination with 37-pos. D-SUB cables and the relevant front adapters. The three module versions are available with screw or Push-in connection technology.

VIP-2/.../D37SUB/M

- In conjunction with FLKM-PA-D37/HW/C300 or FLKM-PA-D37/HW/AN/C300 front adapter
- Universal module
- Field connection via double-level terminal blocks

VIP-2/.../D37SUB/M/SO

- In conjunction with FLKM-PA-D37/HW/C300 front adapter
- System-specific labeling
- Field connection via double-level terminal blocks

VIP-3/.../D37SUB/M/HW/C300

- In conjunction with FLKM-PA-D37/HW/AN/C300 front adapter
- System-specific labeling
- For TAIX01, TAIX11 analog input modules
- Field connection via three-level terminal blocks

Web code for the online configurator

[i] Your web code: #0007

Notes:
For marking systems (e.g., "ZB 22:UNBEDRUCKT"; Order No. 0811862) and mounting material, see Catalog 3.
¹⁾ No UL approval

Maximum permissible operating voltage	
Maximum permissible operating voltage UL / CSA	
Maximum permissible current (per branch)	
Ambient temperature (operation)	
Mounting position	
Standards/regulations	
Connection method	Controller level
Screw connection rigid / flexible / AWG	
Push-in connection rigid / flexible / AWG	
Dimensions	H / D

Description	No. of pos.	Module width W
VARIOFACE interface module, with D-SUB pin strip and universal labeling, - with screw connection	37	101 mm
- with Push-in connection	37	102.8 mm
VARIOFACE interface module, with D-SUB pin strip and system specific labeling, - with screw connection	37	101 mm
- with Push-in connection	37	102.8 mm
VARIOFACE interface module, with D-SUB pin strip for analog input modules, - with screw connection	37	88 mm
- with Push-in connection	37	87.6 mm

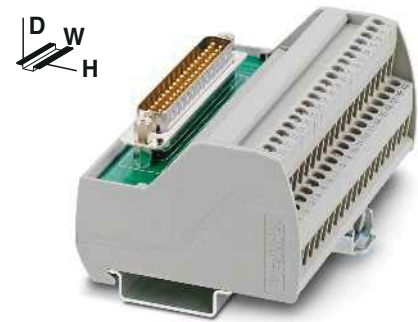

37-pos. with screw or Push-in connection



Technical data	
VIP-2/...	VIP-3/...C300
25 V AC / 60 V DC	25 V AC / 60 V DC
125 V / 105 V	125 V / 105 V
2 A	2 A
-20°C ... 50°C	-20°C ... 50°C
Any	Any
DIN EN 50178	
D-SUB pin strip	D-SUB pin strip
0.2 ... 4 mm ² / 0.2 ... 2.5 mm ² / 24 - 12	
0.14 ... 4 mm ² / 0.14 ... 2.5 mm ² / 26 - 14	
72.1 mm / 46.6 mm	75.8 mm / 63 mm

Ordering data		
Type	Order No.	Pcs./Pkt.
VIP-2/SC/D37SUB/M	2900676	1
VIP-2/PT/D37SUB/M	2904277	1
VIP-2/SC/D37SUB/M/SO ¹⁾	2900786	1
VIP-2/PT/D37SUB/M/SO ¹⁾	2904278	1
VIP-3/SC/D37SUB/M/HW/C300	2900675	1
VIP-3/PT/D37SUB/M/HW/C300	2904276	1

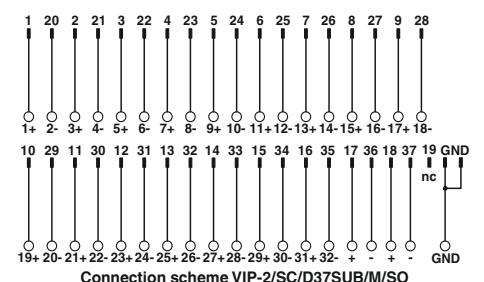
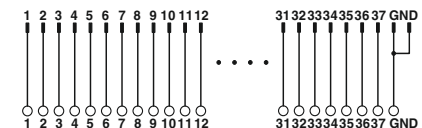
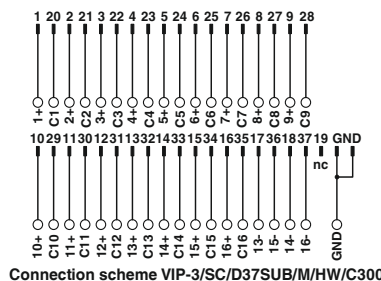

System cabling for controllers

Controller-specific system cabling

Mitsubishi Electric MELSEC Q System cables

For 32- / 64-channel I/O cards with 37-pos. D-SUB connectors. System cables are available for connecting 1 x 32 channels or 4 x 8 channels.

Web code for the online configurator

i Your web code: **#0007**

Notes:
Digital modules such as VIP-2/SC/FLK14/PLC (2315214) can be found starting on page 516
Relay connections using PLC-V8/FLK14/OUT (2295554) and the like can be found starting on page 427



**System cable,
D-SUB socket strip to IDC/FLK socket strip,
number of positions: 37 to 50**



**Splitting cable,
D-SUB socket strip to IDC/FLK socket strip,
number of positions 37 to 4 x 14**



			Technical data			Technical data		
Maximum permissible operating voltage			25 V AC / 60 V DC			25 V AC / 60 V DC		
Maximum permissible operating voltage UL / CSA			125 V / -			125 V / -		
Maximum permissible current carrying capacity per path			1 A			1 A		
Maximum conductor resistance			0.16 Ω/m			0.16 Ω/m		
Ambient temperature (operation)			-20°C ... 50°C			-20°C ... 50°C		
Conductor cross section			AWG 26 / 0.14 mm ²			AWG 26 / 0.14 mm ²		
Conductor structure: stranded wires / material			7 / Cu tin-plated			7 / Cu tin-plated		
Outside diameter			10.5 mm			6.3 mm		
37 -position								
			Ordering data			Ordering data		
Description	No. of pos.	Cable length	Type	Order No.	Pcs./Pkt.	Type	Order No.	Pcs./Pkt.
Round cable for output module MELSEC Q Y81 P, in standard lengths			FLK 50/EZ-DR/D37SUB/ 50/Y81P-O	2302599	1	CABLE-D37-M2,5/4X14/ 50/Y81P-O	2302476	1
	37	0.5 m	FLK 50/EZ-DR/D37SUB/100/Y81P-O	2302609	1	CABLE-D37-M2,5/4X14/100/Y81P-O	2302489	1
	37	1 m	FLK 50/EZ-DR/D37SUB/200/Y81P-O	2302612	1	CABLE-D37-M2,5/4X14/200/Y81P-O	2302492	1
	37	2 m	FLK 50/EZ-DR/D37SUB/300/Y81P-O	2302638	1	CABLE-D37-M2,5/4X14/300/Y81P-O	2302502	1
	37	3 m						
Round cable, same as before, however in variable lengths			FLK 50-EZ-DR-D37SUB-Y81P-O/...	2302625	1	CABLE-D37-M2,5-4X14-Y81P-O/...	2302696	1
	37							
Round cable for input module MELSEC Q X81, in standard lengths			FLK 50/EZ-DR/D37SUB/ 50/X81-I	2302641	1	CABLE-D37-M2,5/4X14/ 50/X81-I	2302515	1
	37	0.5 m	FLK 50/EZ-DR/D37SUB/100/X81-I	2302654	1	CABLE-D37-M2,5/4X14/100/X81-I	2302528	1
	37	1 m	FLK 50/EZ-DR/D37SUB/200/X81-I	2302667	1	CABLE-D37-M2,5/4X14/200/X81-I	2302531	1
	37	2 m	FLK 50/EZ-DR/D37SUB/300/X81-I	2302670	1	CABLE-D37-M2,5/4X14/300/X81-I	2302544	1
	37	3 m						
Round cable, same as before, however in variable lengths			FLK 50-EZ-DR-D37SUB-X81-I/...	2302683	1	CABLE-D37-M2,5-4X14-X81-I/...	2302706	1
	37							

Ordering example for system cable:

- Cable for MELSEC Q Y81P, 12.75 m long

Quantity	Order No.	Length [m] ¹⁾
1	2302625	12.75

¹⁾ min. 0.20 m

Ordering example for splitting cable:

- Cable for MELSEC Q Y81P, 11.00 m long

Quantity	Order No.	Length [m] ¹⁾
1	2302696	11.00

¹⁾ min. 0.20 m

**Mitsubishi Electric
MELSEC L/Q and Honeywell ML 200
System cables**

These system cables are plugged onto the I/O cards that are connected using Fujitsu connectors.

CABLE-FCN40/1X50/...

– Signal transmission of 32 channels

CABLE-FCN40/4X14/...

– Splitting up 32 channels into 4 x 8 channels

Web code for the online configurator

i Your web code: #0007



Fujitsu FCN connector to IDC/FLK socket strip, number of positions: 40 to 50



Fujitsu FCN connector to IDC/FLK socket strip, number of positions: 40 to 4 x 14



Technical data	
Maximum permissible operating voltage	25 V AC / 60 V DC
Maximum permissible operating voltage UL / CSA	125 V / -
Maximum permissible current carrying capacity per path	1 A
Maximum conductor resistance	0.16 Ω/m
Ambient temperature (operation)	-20°C ... 50°C
Conductor cross section	AWG 26 / 0.14 mm ²
Conductor structure: stranded wires / material	7 / Cu tin-plated



Technical data	
Maximum permissible operating voltage	25 V AC / 60 V DC
Maximum permissible operating voltage UL / CSA	125 V / -
Maximum permissible current carrying capacity per path	1 A
Maximum conductor resistance	0.16 Ω/m
Ambient temperature (operation)	-20°C ... 50°C
Conductor cross section	AWG 26 / 0.14 mm ²
Conductor structure: stranded wires / material	7 / Cu tin-plated

Ordering data

Description	No. of pos.	Cable length	Type	Order No.	Pcs./Pkt.
Round cable in variable lengths for Mitsubishi MELSEC L LX41C4, LX42C4 (common positive connection to B01, B02) LY41NT1P, LY42NT1P, LY41PT1P, LY42PT1P					
Mitsubishi MELSEC Q QX41, QX41-S1, QX42, QX42-S1 QX71 and QX72 (common positive connection to B01, B02) QY41P, QY42P, QY71, QH42P					
Honeywell ML 200 2MLQ-TR4A, 2MLQ-TR8A, 2MLQ-TR4B, 2MLQ-TR8B					
	40	0.5 m	CABLE-FCN40/1X50/ 0,5M/IM/MEL	2903468	1
	40	1 m	CABLE-FCN40/1X50/ 1,0M/IM/MEL	2903469	1
	40	2 m	CABLE-FCN40/1X50/ 2,0M/IM/MEL	2903470	1
	40	3 m	CABLE-FCN40/1X50/ 3,0M/IM/MEL	2903471	1
	40	4 m	CABLE-FCN40/1X50/ 4,0M/IM/MEL	2903472	1
	40	6 m	CABLE-FCN40/1X50/ 6,0M/IM/MEL	2903473	1
	40	8 m	CABLE-FCN40/1X50/ 8,0M/IM/MEL	2903474	1
	40	10 m	CABLE-FCN40/1X50/10,0M/IM/MEL	2903475	1
Round cable in variable lengths for Mitsubishi MELSEC L LX41C4 and LX42C4 (common negative connection to B01, B02)					
Mitsubishi MELSEC Q QX71 and QX72 (common negative connection to B01, B02) QX82, QX82-S1					
Honeywell ML 200 2MLI-D24A, 2MLI-D28B, 2MLF-SOEA (common negative connection to B01, B02)					
	40	0.5 m	CABLE-FCN40/1X50/ 0,5M/IP/MEL	2903476	1
	40	1 m	CABLE-FCN40/1X50/ 1,0M/IP/MEL	2903477	1
	40	2 m	CABLE-FCN40/1X50/ 2,0M/IP/MEL	2903478	1
	40	3 m	CABLE-FCN40/1X50/ 3,0M/IP/MEL	2903479	1
	40	4 m	CABLE-FCN40/1X50/ 4,0M/IP/MEL	2903480	1
	40	6 m	CABLE-FCN40/1X50/ 6,0M/IP/MEL	2903481	1
	40	8 m	CABLE-FCN40/1X50/ 8,0M/IP/MEL	2903482	1
	40	10 m	CABLE-FCN40/1X50/10,0M/IP/MEL	2903483	1
Round cable in variable lengths for Mitsubishi MELSEC L LX41C4 and LX42C4 (common positive connection to B01, B02) LY41NT1P, LY42NT1P, LY41PT1P, LY42PT1P					
Mitsubishi MELSEC Q QX41, QX41-S1, QX42, QX42-S1 QY41P (24 V), QY42P (24 V), QH42P (24 V)					
Honeywell ML 200 2MLQ-TR4A, 2MLQ-TR8A, 2MLQ-TR4B, 2MLQ-TR8B					
	40	0.5 m	CABLE-FCN40/4X14/ 0,5M/IM/MEL	2903502	1
	40	1 m	CABLE-FCN40/4X14/ 1,0M/IM/MEL	2903503	1
	40	2 m	CABLE-FCN40/4X14/ 2,0M/IM/MEL	2903504	1
	40	3 m	CABLE-FCN40/4X14/ 3,0M/IM/MEL	2903505	1
	40	4 m	CABLE-FCN40/4X14/ 4,0M/IM/MEL	2903506	1
	40	6 m	CABLE-FCN40/4X14/ 6,0M/IM/MEL	2903507	1
	40	8 m	CABLE-FCN40/4X14/ 8,0M/IM/MEL	2903508	1
	40	10 m	CABLE-FCN40/4X14/10,0M/IM/MEL	2903509	1

Ordering data

Description	No. of pos.	Cable length	Type	Order No.	Pcs./Pkt.
Round cable in variable lengths for Mitsubishi MELSEC L LX41C4 and LX42C4 (common positive connection to B01, B02) LY41NT1P, LY42NT1P, LY41PT1P, LY42PT1P					
Mitsubishi MELSEC Q QX41, QX41-S1, QX42, QX42-S1 QX71 and QX72 (common positive connection to B01, B02) QY41P, QY42P, QY71, QH42P					
Honeywell ML 200 2MLQ-TR4A, 2MLQ-TR8A, 2MLQ-TR4B, 2MLQ-TR8B					
	40	0.5 m	CABLE-FCN40/4X14/ 0,5M/IM/MEL	2903502	1
	40	1 m	CABLE-FCN40/4X14/ 1,0M/IM/MEL	2903503	1
	40	2 m	CABLE-FCN40/4X14/ 2,0M/IM/MEL	2903504	1
	40	3 m	CABLE-FCN40/4X14/ 3,0M/IM/MEL	2903505	1
	40	4 m	CABLE-FCN40/4X14/ 4,0M/IM/MEL	2903506	1
	40	6 m	CABLE-FCN40/4X14/ 6,0M/IM/MEL	2903507	1
	40	8 m	CABLE-FCN40/4X14/ 8,0M/IM/MEL	2903508	1
	40	10 m	CABLE-FCN40/4X14/10,0M/IM/MEL	2903509	1

System cabling for controllers

Controller-specific system cabling

OMRON CJ1, CS1, CQM1 and C200H System cables

These system cables are plugged onto the I/O cards that are connected using Fujitsu connectors.

FLK 50/EZ-DR/...

– Signal transmission of 32 channels

CABLE-FCN40...

– Splitting up 32 channels into 4 x 8 channels



Fujitsu FCN connector to IDC/FLK socket strip, number of positions: 40 to 50



Fujitsu FCN connector to IDC/FLK socket strip, number of positions: 40 to 4 x 14



Maximum permissible operating voltage
Maximum permissible operating voltage UL / CSA

Maximum permissible current carrying capacity per path
Maximum conductor resistance
Ambient temperature (operation)
Conductor cross section
Conductor structure: stranded wires / material

25 V AC / 60 V DC
125 V / -
1 A
0.16 Ω/m
-20°C ... 50°C
AWG 26 / 0.14 mm²
7 / Cu tin-plated

25 V AC / 60 V DC
125 V / -

1 A
0.16 Ω/m
-20°C ... 50°C
AWG 26 / 0.14 mm²
7 / Cu tin-plated

Ordering data

Ordering data

Description	No. of pos.	Cable length
Round cable in variable lengths for CJ1: OD231, OD261 CS1, C200H: OD218, OD219 CQM1: OD213	40	1 m
	40	2 m
Round cable , same as before, however in variable lengths	40	
Round cable in variable lengths for CJ1: ID231, ID261 CS1 and C200H: ID111, ID216, ID217, CQM1: ID213; ID214; ID112	40	1 m
	40	2 m
Round cable , same as before, however in variable lengths	40	

Type	Order No.	Pcs./Pkt.
FLK 50/EZ-DR/FCN40/100/OMR-OUT	2304144	1
FLK 50/EZ-DR/FCN40/200/OMR-OUT	2304157	1
FLK 50-EZ-DR-FCN40-OMR-OUT/...	2302829	1
FLK 50/EZ-DR/FCN40/100/OMR-IN	2304160	1
FLK 50/EZ-DR/FCN40/200/OMR-IN	2304173	1
FLK 50-EZ-DR-FCN40-OMR-IN/...	2302803	1

Type	Order No.	Pcs./Pkt.
CABLE-FCN40/4X14/100/OMR-OUT	2304186	1
CABLE-FCN40/4X14/200/OMR-OUT	2304199	1
CABLE-FCN40-4X14-OMR-OUT/...	2302832	1
CABLE-FCN40/4X14/100/OMR-IN	2304209	1
CABLE-FCN40/4X14/200/OMR-IN	2304212	1
CABLE-FCN40-4X14-OMR-IN/...	2302816	1

Ordering example for system cable:

– Cable for OMRON CJ1, ID231, 12.75 m long

Quantity	Order No.	Length [m] ¹⁾
1	2302803	12.75

¹⁾ min. 0.20 m

Phoenix Contact Axioline real-time I/O system cables

These cables have been specifically developed for connecting VARIOFACE termination boards to the Axioline realtime I/O system. The Push-in technology on the I/O system ensures rapid connection.

The cables have the following features:

- 1:1 connection
 - 14-pos. connector, encapsulated
 - 8 pre-assembled open ends, for connection to the Axioline realtime I/O system
 - Transmission of groups of 8 channels
- Perfectly-fitting VARIOFACE termination boards round off this system concept.

Notes:

The following modules cannot be coupled due to the larger outer contour of the encapsulated connectors:
 UM 45-FLK14/ 8IM/ZFKDS/PLC, [2965211](#)
 UM 45- 8RM/MR-G24/1/PLC, [2962900](#)

Digital modules such as VIP-2/SC/FLK14/PLC ([2315214](#)) can be found starting on page 516

Relay connections using PLC-V8/FLK14/OUT ([2295554](#)) and the like can be found starting on page 427



System cable for 8 channels



Technical data

Maximum permissible operating voltage	25 V AC / 60 V DC
Maximum permissible operating voltage UL / CSA	125 V / -
Maximum permissible current carrying capacity per path	1 A
Maximum conductor resistance	0.16 Ω/m
Ambient temperature (operation)	-20°C ... 50°C
Assembly	Insulation displacement, IEC 60352-4/DIN EN 60352-4
Conductor cross section	AWG 26 / 0.14 mm ²
Conductor structure: stranded wires / material	7 / Cu tin-plated
Outside diameter	6.4 mm
	8 -position

Ordering data

Description	No. of pos.	Cable length	Type	Order No.	Pcs./Pkt.
Round cable with an open end (8 individual wires)					
	8	0.5 m	VIP-CAB-FLK14/AXIO/0,14/0,5M	2901604	1
	8	1 m	VIP-CAB-FLK14/AXIO/0,14/1,0M	2901605	1
	8	1.5 m	VIP-CAB-FLK14/AXIO/0,14/1,5M	2901606	1
	8	2 m	VIP-CAB-FLK14/AXIO/0,14/2,0M	2901607	1
	8	2.5 m	VIP-CAB-FLK14/AXIO/0,14/2,5M	2901608	1
	8	3 m	VIP-CAB-FLK14/AXIO/0,14/3,0M	2901609	1
	8	4 m	VIP-CAB-FLK14/AXIO/0,14/4,0M	2901610	1
	8	6 m	VIP-CAB-FLK14/AXIO/0,14/6,0M	2901611	1



Controller-specific system cabling

Phoenix Contact Inline Front adapters

The front adapters are used to connect pre-assembled system cables directly to Inline. Front adapters are simply plugged into the relevant Inline modules. Three connection options are available:

- Transfer of 8 channels via a 14-pos. system cable
- Transmission of 2 x 8 channels over two 14-position system cables
- Transmission of 4 x 8 channels over four 14-position system cables

Perfectly-fitting VARIOFACE termination boards round off this system concept.

Web code for the online configurator

i Your web code: **#0007**

Notes:
Digital modules such as VIP-2/SC/FLK14/PLC (2315214) can be found starting on page 516
Relay connections using PLC-V8/FLK14/OUT (2295554) and the like can be found starting on page 427
For system cables, see page 536

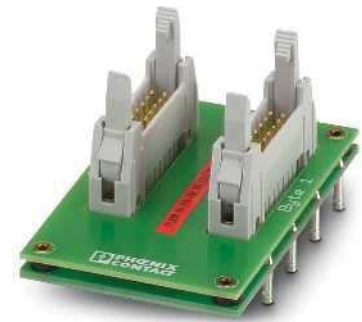

Front adapter for Inline

ERIC

Technical data

60 V DC
 1 A (per path)
 -20°C ... 50°C
 -20°C ... 70°C
 Any
 IEC 60664 / DIN EN 50178

Ordering data

Description	No. of pos.	Type	Order No.	Pcs./Pkt.
VARIOFACE front adapter , for 8-channel Inline modules				
Input: IB IL 24 D I8/HD-PAC Output: IB IL 24 DO 8/HD-PAC	14	FLKM 14-PA-INLINE/DIO8	2900889	1
VARIOFACE front adapter , for 16-channel Inline modules				
Input: IB IL 24 DI 16-PAC Output: IB IL 24 DO 16-PAC	14	FLKM 14-PA-INLINE/IN16	2302751	1
	14	FLKM 14-PA-INLINE/OUT16	2302764	1
VARIOFACE front adapter , for 32-channel Inline modules				
Input: IB IL 24 DI 32/HD-PAC and IB IL 24 DI 32/HD-NPN-PAC Output: IB IL 24 DO 32/HD-PAC	14	FLKM 14-PA-INLINE/32	2302777	1

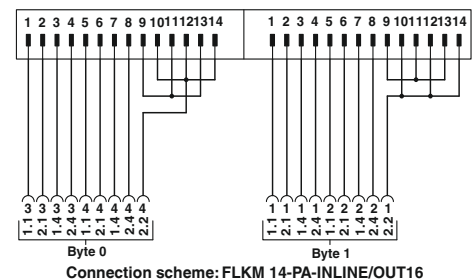
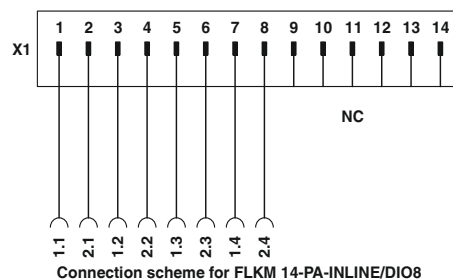
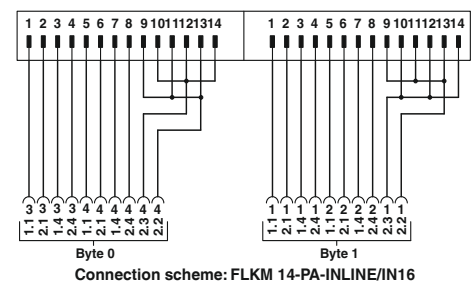
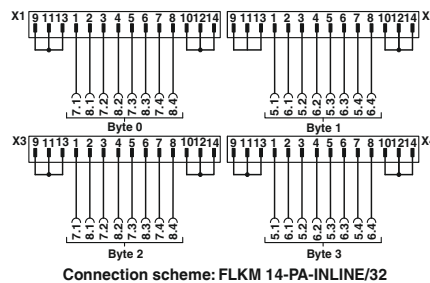
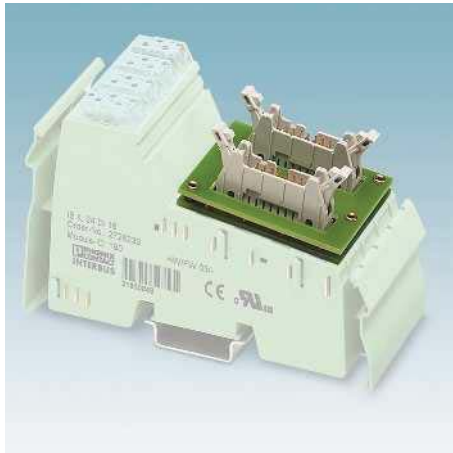

Explanation:
 IDC/FLK strip
 Connection to I/O card
 Screw terminal blocks for separate supply

Controller-specific system cabling

Schneider Electric Modicon® TSX Quantum™ Front adapters

The front adapters mean that preassembled system cables can be directly connected to I/O modules. There are two connection possibilities available:

- Transfer of max. 32 channels over one 50-position system cable
- Transmission of 4 x 8 channels over four 14-position system cables

Perfectly-fitting VARIOFACE termination boards with a variety of functions and connection possibilities round off this system concept.

Web code for the online configurator

i Your web code: #0007

Notes:
Controller-specific modules from page 489
Digital modules such as VIP-2/SC/FLK14/PLC (2315214) can be found starting on page 516
Relay connections using PLC-V8/FLK14/OUT (2295554) and the like can be found starting on page 427
For system cables, see page 536



Front adapter for
Modicon® TSX Quantum™



Technical data

Maximum permissible operating voltage	25 V AC / 60 V DC
Maximum permissible operating voltage UL / CSA	125 V / -
Maximum permissible current	1 A (per path) 4 A (per connection, supply via separate power supply)
Ambient temperature (operation)	-20°C ... 50°C
Ambient temperature (storage/transport)	-20°C ... 70°C
Mounting position	Any
Standards/regulations	IEC 60664 / DIN EN 50178

25 V AC / 60 V DC
125 V / -
1 A (per path) 4 A (per connection, supply via separate power supply)
-20°C ... 50°C
-20°C ... 70°C
Any
IEC 60664 / DIN EN 50178

Ordering data

Description	No. of pos.
VARIOFACE front adapter , for Modicon® TSX Quantum™, 1 x 32 channels can be connected	50
VARIOFACE front adapter , for Modicon® TSX Quantum™, 4 x 8 channels can be connected	14

Type	Order No.	Pcs./Pkt.
FLKM 50-PA-MODI-TSX/Q	2294306	1
FLKM 50/ 4-FLK14/PA-MODI-TSX/Q	2294416	1

Front adapters for I/O modules of the Modicon TSX Quantum™ automation devices

Card type	FLKM 50-PA-MODI-TSX/Q
Digital input	DDI 353 DDI 841* DDI 853 DAI 340* DAI 353** DAI 440*
Digital output	DDO 353
Digital input/output	DDM 390*
Analog input	ACI 030* ACI 040* ATI 030* ARI 030* AVI 030*
Analog output	ACO 020* ACO 130* AVO 020*
Analog input/output	AMM 090*
Counter	ECH 105* EHC 202*

Card type	FLKM 50/4-FLK14/PA-MODI-TSX/Q
Digital input	DDI 353 DDI 853 DAI 353**
Digital output	DDO 353

* Only in conjunction with VIP-2/SC/FLK50/MODI-TSX/Q, Order No.: 2322304
VIP-2/PT/FLK50/MODI-TSX-Q, Order No.: 2904285

** Only in conjunction with passive interface modules without LED.

Explanation:

- IDC/FLK strip
- Connection to I/O card
- Screw terminal blocks for separate supply

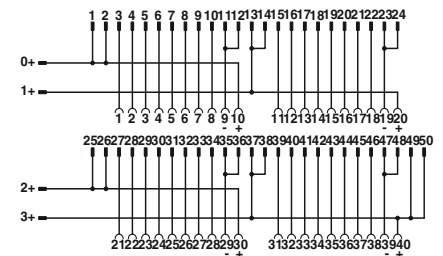

Connection scheme FLKM 50-PA-MODI-TSX/Q

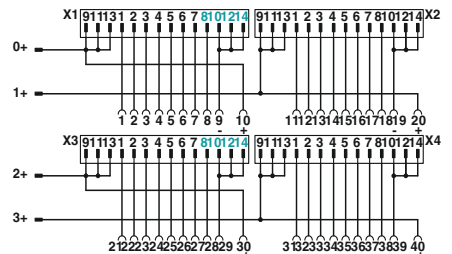

Connection scheme FLKM 50/ 4-FLK14/PA-MODI-TSX/Q

**Schneider Electric
Modicon® TSX Quantum™
VIP interface modules**

These VIP – VARIOFACE Professional modules are used in combination with 50-pos. system cables and the relevant front adapters.

Features:

- Specific marking
- Specifically for Modicon® TSX Quantum™

Notes:
For marking systems (e.g., "ZB 22:UNBEDRUCKT"; Order No, 0811962) and mounting material, see Catalog 3.

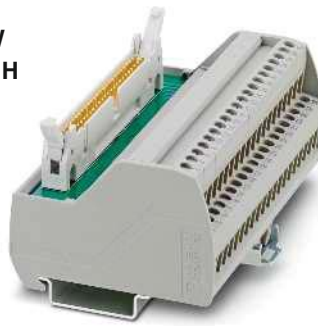

**Passive termination board
For Modicon® TSX Quantum™
with screw connection**

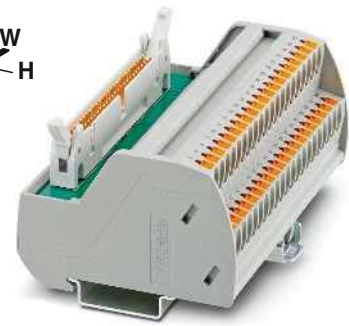

**Passive termination board
For Modicon® TSX Quantum™
with Push-in connection**



Technical data

Maximum permissible operating voltage	25 V AC / 60 V DC
Maximum permissible operating voltage UL / CSA	125 V / -
Maximum permissible current (per branch)	1 A
Ambient temperature (operation)	-20°C ... 50°C
Mounting position	any
Standards/regulations	IEC 60664, DIN EN 50178
Connection method	Screw connection
	Field level
	Controller level
Connection data solid/stranded/AWG	IDC/FLK pin strip 0.2 ... 4 mm ² / 0.2 ... 2.5 mm ² / 24 - 12
Dimensions	65.5 mm / 56 mm

Technical data

Maximum permissible operating voltage	25 V AC / 60 V DC
Maximum permissible operating voltage UL / CSA	125 V / 125 V
Maximum permissible current (per branch)	1 A
Ambient temperature (operation)	-20°C ... 50°C
Mounting position	any
Standards/regulations	IEC 60664, DIN EN 50178
Connection method	Push-in connection
Connection data solid/stranded/AWG	IDC/FLK pin strip 0.14 ... 2.5 mm ² / 0.14 ... 2.5 mm ² / 26 - 14
Dimensions	72.1 mm / 56 mm

Ordering data

Description	No. of pos.	Module width W
VARIOFACE termination board, with Modicon® TSX Quantum™-specific marking from 1 to 40		
- with screw connection	50	106.1 mm
- with Push-in connection	50	107.9 mm

Type	Order No.	Pcs./Pkt.
VIP-2/SC/FLK50/MODI-TSX/Q	2322304	1

Ordering data

Type	Order No.	Pcs./Pkt.
VIP-2/PT/FLK50/MODI-TSX/Q	2904285	1

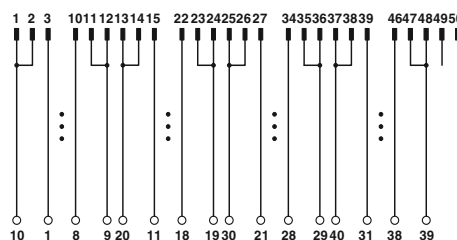

Connection scheme VIP-2/.../FLK50/MODI-TSX/Q

System cabling for controllers

Controller-specific system cabling

Schneider Electric Modicon® M340™ Front adapters

Pre-assembled system cables are connected directly to the 16-channel I/O modules using the front adapter. The adapters connect 2 x 8 channels of the controller via two 14-pos. system cables. Tailor-made VARIOFACE termination boards with a variety of functions and connection options are available for connection to field level. They round off this system concept.

Web code for the online configurator

i Your web code: **#0007**

Notes:
Digital modules such as VIP-2/SC/FLK14/PLC (2315214) can be found starting on page 516
Relay connections using PLC-V8/FLK14/OUT (2295554) and the like can be found starting on page 427
For system cables, see page 536



Schneider Electric Modicon M340™ front adapter



Technical data

Maximum permissible operating voltage	25 V AC / 60 V DC
Maximum permissible operating voltage UL / CSA	50 V / 50 V
Maximum permissible current	1 A (per path)
Maximum permissible total current	3 A (per system cable when supplying from the module side) 10 A (when supplying via the front adapter)
Ambient temperature (operation)	-20°C ... 60°C
Ambient temperature (storage/transport)	-20°C ... 60°C
Mounting position	any
Standards/regulations	IEC 60664 / DIN EN 50178

Ordering data

Description	No. of pos.	Type	Order No.	Pcs./Pkt.
VARIOFACE front adapter , for Modicon® M340™ with two FLK pin strips	14	FLKM 14-PA-MODI/M340	2903208	1

Front adapters for I/O modules of the Modicon® M340™ series

Card type	FLKM 14-PA-MODI/M340
Digital input	BMX DDI1602 BMX DDI1603 BMX DAI1602 BMX DAI1603
Digital output	BMX DDO1602 BMX DDO1612

Assignment table

Contacts of front adapter/ controller	Connectors (Byte 0)	Connectors (Byte 1)
1	1	
2	2	
3	3	
4	4	
5	5	
6	6	
7	7	
8	8	
9		1
10		2
11		3
12		4
13		5
14		6
15		7
16		8
17	10, 12, 14 (-)	10, 12, 14 (-)
18	9, 11, 13 (+)	9, 11, 13 (+)
19	10, 12, 14 (-)	10, 12, 14 (-)
20	9, 11, 13 (+)	9, 11, 13 (+)

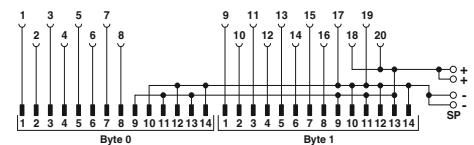

Connection scheme FLKM 14-PA-MODI/M340

**Schneider Electric Modicon® M340™
System cables**

These system cables are plugged onto the I/O cards that are connected using Fujitsu connectors.

CABLE-FCN40/1X50/...

– Signal transmission of 32 channels

CABLE-FCN40/4X14/...

– Splitting up 32 channels into 4 x 8 channels

Web code for the online configurator

i Your web code: #0007



Fujitsu FCN connector to IDC/FLK socket strip, number of positions: 40 to 50



Fujitsu FCN connector to IDC/FLK socket strip, number of positions: 40 to 4 x 14



Technical data

Maximum permissible operating voltage	25 V AC / 60 V DC
Maximum permissible operating voltage UL / CSA	125 V / -
Maximum permissible current carrying capacity per path	1 A
Maximum conductor resistance	0.16 Ω/m
Ambient temperature (operation)	-20°C ... 50°C
Conductor cross section	AWG 26 / 0.14 mm ²
Conductor structure: stranded wires / material	7 / Cu tin-plated

Ordering data

Description	No. of pos.	Cable length
Round cable in variable lengths for BMX DDI 3202K, BMX DDI 6402K, BMX DD0 3202K, BMX DD0 6402K, BMX DDM 3202K		
	40	0.5 m
	40	1 m
	40	2 m
	40	3 m
	40	4 m
	40	6 m
	40	8 m
	40	10 m
	40	15 m

Type	Order No.	Pcs./Pkt.
CABLE-FCN40/1X50/ 0,5M/M340	2321635	1
CABLE-FCN40/1X50/ 1,0M/M340	2321648	1
CABLE-FCN40/1X50/ 2,0M/M340	2321651	1
CABLE-FCN40/1X50/ 3,0M/M340	2321664	1
CABLE-FCN40/1X50/ 4,0M/M340	2321677	1
CABLE-FCN40/1X50/ 6,0M/M340	2321680	1
CABLE-FCN40/1X50/ 8,0M/M340	2321693	1
CABLE-FCN40/1X50/10,0M/M340	2321703	1
CABLE-FCN40/1X50/15,0M/M340	2903748	1



Technical data

Maximum permissible operating voltage	25 V AC / 60 V DC
Maximum permissible operating voltage UL / CSA	125 V / -
Maximum permissible current carrying capacity per path	1 A
Maximum conductor resistance	0.16 Ω/m
Ambient temperature (operation)	-20°C ... 50°C
Conductor cross section	AWG 26 / 0.14 mm ²
Conductor structure: stranded wires / material	7 / Cu tin-plated

Ordering data

Type	Order No.	Pcs./Pkt.
CABLE-FCN40/4X14/ 0,5M/M340	2321716	1
CABLE-FCN40/4X14/ 1,0M/M340	2321729	1
CABLE-FCN40/4X14/ 2,0M/M340	2321732	1
CABLE-FCN40/4X14/ 3,0M/M340	2321745	1
CABLE-FCN40/4X14/ 4,0M/M340	2321758	1
CABLE-FCN40/4X14/ 6,0M/M340	2321761	1
CABLE-FCN40/4X14/ 8,0M/M340	2321774	1
CABLE-FCN40/4X14/10,0M/M340	2321787	1
CABLE-FCN40/4X14/15,0M/M340	2903749	1

System cabling for controllers

Controller-specific system cabling

Siemens SIMATIC® S7-1500

Front adapters

Digital I/O modules with 32 channels

There are two connection possibilities available:

- Transfer of max. 32 channels over one 50-position system cable
- Transmission of 4 x 8 channels via a 14-pos. system cable

Digital I/O modules with 16 channels

- Transmission of 2 x 8 channels over two 14-position system cables.

Perfectly-fitting VARIOFACE termination boards with a variety of functions and connection possibilities round off this system concept.

Web code for the online configurator

i Your web code: #0007

Notes:

Digital modules such as VIP-2/SC/FLK14/PLC (2315214) can be found starting on page 516

Relay connections using PLC-V8/FLK14/OUT (2295554) and the like can be found starting on page 427

For system cables, see page 536



Front adapter for SIMATIC® S7-1500 digital I/O cards



Technical data

Maximum permissible operating voltage
Maximum permissible current
Maximum permissible total current

Ambient temperature (operation)
Ambient temperature (storage/transport)
Standards/regulations
Connection method

<50 V DC
1 A (per path)
2 A (per byte when supplying from the module side)
12 A (when supplying via the front adapter)
-25°C ... 60°C
-40°C ... 70°C
IEC 61131-2
IDC/FLK pin strip

Ordering data

Description	No. of pos.
VARIOFACE front adapter , for SIMATIC® S7-1500 digital 35 mm modules, 1 x 32 channels can be connected	
- with screw connection	50
- with Push-in connection	50
VARIOFACE front adapter , for SIMATIC® S7-1500 digital 35 mm modules, 4 x 8 or 2 x 8 channels can be connected	
- with screw connection	14
- with Push-in connection	14

Type	Order No.	Pcs./Pkt.
FLKM 50-PA/SC/DIO/S7-1500	2907383	1
FLKM 50-PA/PT/DIO/S7-1500	2907384	1
FLKM 4X14-PA/SC/DIO/S7-1500	2907381	1
FLKM 4X14-PA/PT/DIO/S7-1500	2907382	1

Front adapters for 32-channel digital cards of the SIMATIC® S7-1500

Card type	FLKM 50-PA/.../DIO/S7-1500 FLKM 4X14-PA/.../DIO/S7-1500
Digital input	6ES7 521-1BL00-0AB0
Digital output	6ES7 522-1BL00-0AB0 6ES7 522-1BL01-0AB0

Front adapters for 16-channel digital cards of the SIMATIC® S7-1500

Card type	FLKM 4X14-PA/.../DIO/S7-1500
Digital input	6ES7 521-1BH00-0AB0 6ES7 521-1BH50-0AA0
Digital output	6ES7 522-1BH00-0AB0 6ES7 522-1BH01-0AB0

Note:

The front adapters are non-isolated on delivery. Electrical isolation is achieved by removing the wire bridges (in groups of 8).

Explanation:

- IDC/FLK strip
- Connection to I/O card
- Screw terminal blocks for separate supply

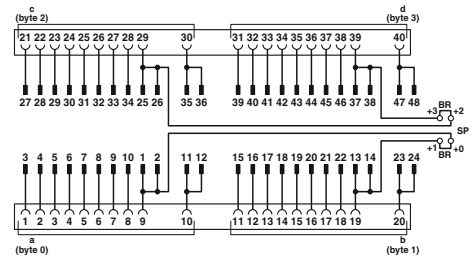

Connection scheme for FLKM 50-PA/.../DIO/S7-1500

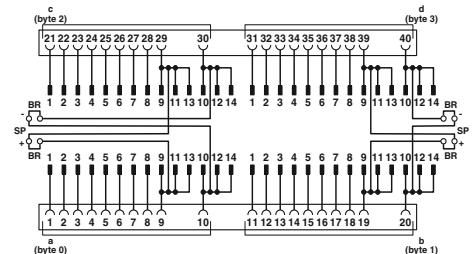

Connection scheme for FLKM 4X14-PA/.../DIO/S7-1500

Siemens SIMATIC® S7-1500

Front adapters

Analog I/O modules with 8 channels

There are two connection possibilities available:

- Transmission of a maximum of 8 channels via a 50-pos. system cable
- Transmission of 4 x 2 channels via a 14-pos. system cable

Analog I/O modules with 4 channels

- Transmission of 2 x 2 channels via two 14-pos. system cables

Web code for the online configurator

i Your web code: **#0007**

Notes:

- Controller-specific modules from page 494
- For system cables, see page 536



Front adapter for SIMATIC® S7-1500 analog I/O cards



Technical data

<50 V DC
1 A (per path)
-25°C ... 60°C
-40°C ... 70°C
IEC 61131-2
IDC/FLK pin strip

Ordering data

Description	No. of pos.
VARIOFACE front adapter , for SIMATIC® S7-1500 analog 35 mm modules	
- 8 channels can be connected	50
- 4 x 2 or 2 x 2 channels can be connected	14

Type	Order No.	Pcs./Pkt.
FLKM 50-PA/AN/S7-1500	2907386	1
FLKM 4X14-PA/AN/S7-1500	2907385	1

Front adapters for 8-channel analog cards of the SIMATIC® S7-1500 (only one 50-pos. cable is connected)

Card type	FLKM 50-PA/AN/S7-1500
Analog input	6ES7 531-7KF00-0AB0* 6ES7 531-7NF00-0AB0* 6ES7 531-7NF10-0AB0* 6ES7 531-7PF00-0AB0*
Analog output	6ES7 532-5HF00-0AB0*

Front adapters for 8-channel analog cards of the SIMATIC® S7-1500 (four 14-pos. cables are connected)

Card type	FLKM 4X14-PA/AN/S7-1500
Analog input	6ES7 531-7KF00-0AB0** 6ES7 531-7NF00-0AB0** 6ES7 531-7NF10-0AB0** 6ES7 531-7PF00-0AB0**
Analog output	6ES7 532-5HF00-0AB0**

Front adapters for 4-channel analog cards of the SIMATIC® S7-1500 (only two 14-pos. cables are connected)

Card type	FLKM 4X14-PA/AN/S7-1500
Analog output	6ES7 532-5HD00-0AB0*** 6ES7 532-5ND00-0AB0***

* Only in conjunction with
VIP-3/PT/FLK50/AN/S7-1500, Order No.: 2908496
VIP-3/SC/FLK50/AN/S7-1500, Order No.: 2908495
VIP-3/PT/FLK50/AN/2P/S7-1500, Order No.: 2908499
VIP-3/SC/FLK50/AN/2P/S7-1500, Order No.: 2908497
FLKM 50/KDS3-MT/PPA/S7-1500, Order No.: 2909893

** Only in conjunction with
VIP-3/PT/2FLK14/AN/2P/S7-1500A, Order No.: 2908465
VIP-3/SC/2FLK14/AN/2P/S7-1500A, Order No.: 2908464
VIP-3/PT/2FLK14/AN/2P/S7-1500B, Order No.: 2908846
VIP-3/SC/2FLK14/AN/2P/S7-1500B, Order No.: 2908845
FLKM-2FLK14/KDS3-MT/AN/S7-1500, Order No.: 2909894

*** Only in conjunction with
VIP-3/PT/2FLK14/AN/2P/S7-1500A, Order No.: 2908465
VIP-3/SC/2FLK14/AN/2P/S7-1500A, Order No.: 2908464
FLKM-2FLK14/KDS3-MT/AN/S7-1500, Order No.: 2909894

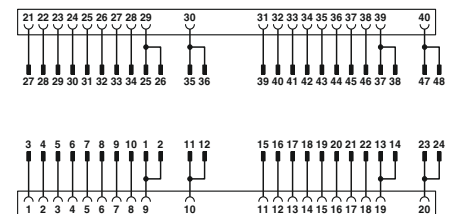

Connection scheme FLKM 50-PA/AN/S7-1500

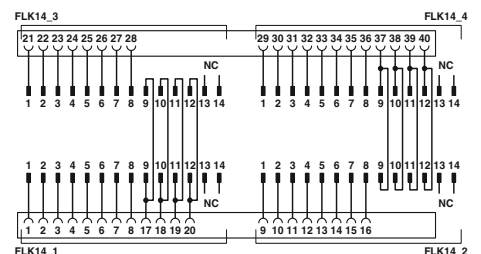

Connection scheme FLKM 4X14-PA/AN/S7-1500

System cabling for controllers

Controller-specific system cabling

Siemens SIMATIC® S7-1500 Analog interface modules

VARIOFACE termination boards with SIMATIC® S7-1500-specific marking.

- One 50-pos. IDC/FLK pin strip
- Numerical marking (1-40)
- Optional: separate potentials L+, M, P1, and P2
- Specifically for S7-1500

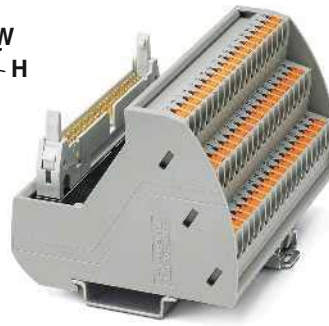

Passive termination board
for SIMATIC® S7-1500
with separate potentials

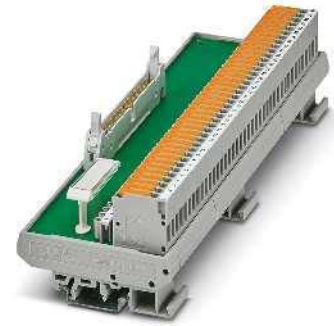

Passive termination board
for SIMATIC® S7-1500
with knife disconnect terminal blocks



Maximum permissible operating voltage
Maximum permissible operating voltage UL / CSA

Maximum permissible current (per branch)
Maximum total current (voltage supply)

Ambient temperature (operation)
Mounting position

Standards/regulations

Connection method

Field level
Controller level

Screw connection rigid / flexible / AWG

Push-in connection rigid / flexible / AWG

Dimensions

H / D

Technical data

VIP-3/PT/FLK50/AN.../S7-1500	VIP-3/SC/FLK50/AN.../S7-1500
25 V AC / 60 V DC	25 V AC / 60 V DC
60 V / 60 V	60 V / 60 V

1 A	1 A
7 A	7 A

-20°C ... 60°C	-20°C ... 60°C
Any	Any

IEC 60664, DIN EN 50178

Push-in connection

IDC/FLK pin strip

0.2 ... 4 mm² / 0.2 ... 2.5 mm² / 24 - 12

0.14 ... 2.5 mm² / 0.14 ... 2.5 mm² / 26 - 14

75.8 mm / 63 mm

Screw connection

IDC/FLK pin strip

0.2 ... 4 mm² / 0.2 ... 2.5 mm² / 24 - 12

- ... - / - ... - / -

68.8 mm / 60.7 mm

Technical data

FLKM 50/KDS3-MT/PPA/S7-1500
25 V AC / 60 V DC
- / -

1 A
-

-20°C ... 70°C
Any

DIN EN 50178

Screw connection with disconnect knife

IDC/FLK pin strip

0.2 ... 4 mm² / 0.2 ... 2.5 mm² / 24 - 12

- ... - / - ... - / -

77 mm / 61 mm

- / -

Ordering data

Description	No. of pos.	Module width W
VARIOFACE termination board for SIMATIC® S7-1500, marking 1 through 40, with potentials L+ and M		
- with Push-in connection	50	97.7 mm
- with screw connection	50	97.7 mm
VARIOFACE termination board for SIMATIC® S7-1500, marking 1 through 40, with potentials L+, M, P1, and P2		
- with Push-in connection	50	128.2 mm
- with screw connection	50	128.2 mm
VARIOFACE termination board for SIMATIC® S7-1500, marking 1 through 40, knife disconnect terminal blocks and test sockets		213.8 mm

Type	Order No.	Pcs./Pkt.
VIP-3/PT/FLK50/AN/S7-1500	2908496	1
VIP-3/SC/FLK50/AN/S7-1500	2908495	1
VIP-3/PT/FLK50/AN/2P/S7-1500	2908499	1
VIP-3/SC/FLK50/AN/2P/S7-1500	2908497	1

Ordering data

Type	Order No.	Pcs./Pkt.
FLKM 50/KDS3-MT/PPA/S7-1500	2909893	1

Siemens SIMATIC® S7-1500 Analog interface modules

VARIOFACE termination boards with SIMATIC® S7-1500-specific marking.

- Two 14-pos. IDC/FLK pin strips
- Numerical marking (1-20 or 21-40)
- Optional: separate potentials L+, M, P1, and P2
- Specifically for S7-1500

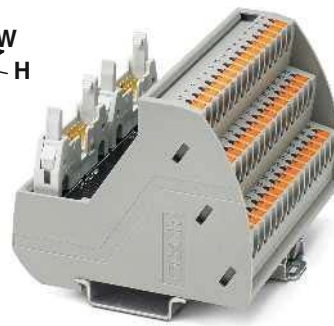

Passive termination board for SIMATIC® S7-1500 with separate potentials

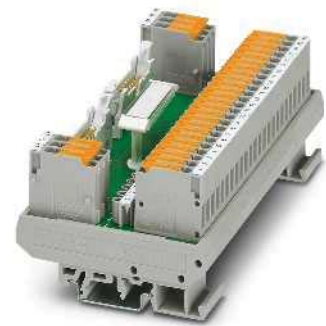

Passive termination board for SIMATIC® S7-1500 with knife disconnect terminal blocks



		Technical data		Technical data	
		VIP-3/PT/2FLK14/AN/2P/S7-11500...	VIP-3/SC/2FLK14/AN/2P/S7-1500...	FLKM-2FLK14/KDS3-MT/AN/S7-1500	
Maximum permissible operating voltage		25 V AC / 60 V DC	25 V AC / 60 V DC	25 V AC / 60 V DC	
Maximum permissible operating voltage UL / CSA		60 V / 60 V	60 V / 60 V	- / -	
Maximum permissible current (per branch)		1 A	1 A	1 A	
Maximum total current (voltage supply)		7 A	7 A	-	
Ambient temperature (operation)		-20°C ... 60°C	-20°C ... 60°C	-20°C ... 70°C	
Mounting position		Any	Any	Any	
Standards/regulations		IEC 60664, DIN EN 50178		DIN EN 50178	
Connection method	Field level	Push-in connection	Screw connection	Screw connection with disconnect knife	
	Controller level	IDC/FLK pin strip	IDC/FLK pin strip	IDC/FLK pin strip	
Screw connection rigid / flexible / AWG		0.2 ... 4 mm ² / 0.2 ... 2.5 mm ² / 24 - 12		0.2 ... 4 mm ² / 0.2 ... 2.5 mm ² / 24 - 12	
Push-in connection rigid / flexible / AWG		0.14 ... 2.5 mm ² / 0.14 ... 2.5 mm ² / 26 - 14		- ... - / - ... - / -	
Dimensions	H / D	75.8 mm / 63 mm	68.8 mm / 60.7 mm	77 mm / 61 mm	- / -

			Ordering data			Ordering data		
Description	No. of pos.	Module width W	Type	Order No.	Pcs./Pkt.	Type	Order No.	Pcs./Pkt.
VARIOFACE termination board for SIMATIC® S7-1500, marking 1 through 20, with potentials L+, M, P1, and P2								
- with Push-in connection	14	82.5 mm	VIP-3/PT/2FLK14/AN/2P/S7-1500A	2908465	1			
- with screw connection	14	82.5 mm	VIP-3/SC/2FLK14/AN/2P/S7-1500A	2908464	1			
VARIOFACE termination board for SIMATIC® S7-1500, marking 21 through 40, with potentials L+, M, P1, and P2								
- with Push-in connection	14	82.5 mm	VIP-3/PT/2FLK14/AN/2P/S7-1500B	2908846	1			
- with screw connection	14	82.5 mm	VIP-3/SC/2FLK14/AN/2P/S7-1500B	2908845	1			
VARIOFACE termination board for SIMATIC® S7-1500, marking 1 through 20 or 21 through 40, knife disconnect terminal blocks and test sockets								
		135 mm				FLKM-2FLK14/KDS3-MT/AN/S7-1500	2909894	1

System cabling for controllers

Controller-specific system cabling

VIP – power cabling

Universal front adapters for Siemens SIMATIC® S7-300

Two versions are available:

- Connection of 40-pos. modules via four cables, each with a 10-pos. COMBI connector
- Connection of 20-pos. modules via two cables, each with a 10-pos. COMBI connector

The front adapters have the following features:

- Can be screwed on/snapped in with the I/O module
- Suitable for all common S7-300 modules, up to max. 250 V AC/DC, 6 A
- Universal 1:1 connection
- Numerically marked connectors

Combination example:

A front adapter with attached 10-pos. COMBI connectors is combined with the following terminal blocks for field connection:

- Overall width of 52 mm per connector:
- 3045017 UT 2,5/1P
- 3210033 PT 2,5/1P
- 3040012 ST 2,5/1P
- 3040766 ST 2,5-TWIN-MT/1P

Reduced overall width of 35 mm per connector:

- 3208582 PT 1,5/S/1P
- 3212439 PTTB 1,5/S/2P

You can find further versions, accessories, and combination options in Catalog 1 “Terminal blocks” in the “Plug-in COMBI connection solutions” section or online at phoenixcontact.net/products.

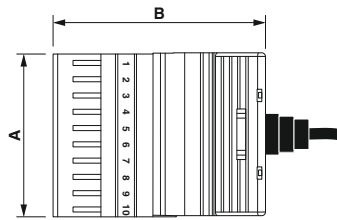

	A	B
...4X10COMBI...	52	70
...2X10COMBI...		
...4X10 PT...	35	62
...2X10 PT...		



Front adapter with punched-on connectors for 40 plug-in modular terminal blocks

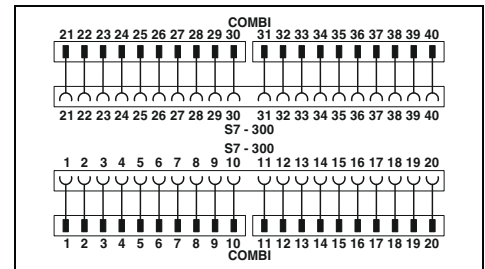

Technical data

Maximum permissible operating voltage	250 V AC/DC
Maximum permissible operating voltage UL / CSA	250 V / 250 V
Maximum permissible current	6 A (per single wire at 40°C) 4 A (per single wire at 60°C)
Maximum permissible total current	20 A (per cable at 40°C) 16 A (per cable at 60°C)
Maximum conductor resistance	39 Ω/km
Conductor cross section	AWG 21 / 0.5 mm ²
Conductor structure: stranded wires / material	16 / Cu uninsulated
Outside diameter	9 mm
Ambient temperature range	-20°C ... 60°C
Standards/regulations	DIN EN 50178, IEC 60664
Connection method	Plug connection

Maximum permissible operating voltage	250 V AC/DC
Maximum permissible operating voltage UL / CSA	250 V / 250 V
Maximum permissible current	6 A (per single wire at 40°C) 4 A (per single wire at 60°C)
Maximum permissible total current	20 A (per cable at 40°C) 16 A (per cable at 60°C)
Maximum conductor resistance	39 Ω/km
Conductor cross section	AWG 21 / 0.5 mm ²
Conductor structure: stranded wires / material	16 / Cu uninsulated
Outside diameter	9 mm
Ambient temperature range	-20°C ... 60°C
Standards/regulations	DIN EN 50178, IEC 60664
Connection method	Plug connection

Controller level
Field level

Ordering data

Description	Cable length	Type	Order No.	Pcs./Pkt.
VIP - power cabling front adapter, for universal connection of the SIMATIC® S7-300, with an overall width of 52 mm per connector	1 m	VIP-PA-PWR/4X10COMBI/ 1,0M/S7	2904703	1
	1.5 m	VIP-PA-PWR/4X10COMBI/ 1,5M/S7	2904704	1
	2 m	VIP-PA-PWR/4X10COMBI/ 2,0M/S7	2904705	1
	2.5 m	VIP-PA-PWR/4X10COMBI/ 2,5M/S7	2904706	1
	3 m	VIP-PA-PWR/4X10COMBI/ 3,0M/S7	2904707	1
	4 m	VIP-PA-PWR/4X10COMBI/ 4,0M/S7	2904708	1
	10 m	VIP-PA-PWR/4X10COMBI/10,0M/S7	2904712	1
VIP - power cabling front adapter, for universal connection of the SIMATIC® S7-300, with reduced overall width of 35 mm per connector	1 m	VIP-PA-PWR/4X10 PT/ 1,0M/S7	2905517	1
	1.5 m	VIP-PA-PWR/4X10 PT/ 1,5M/S7	2905518	1
	2 m	VIP-PA-PWR/4X10 PT/ 2,0M/S7	2905519	1
	2.5 m	VIP-PA-PWR/4X10 PT/ 2,5M/S7	2905520	1
	3 m	VIP-PA-PWR/4X10 PT/ 3,0M/S7	2905521	1
	4 m	VIP-PA-PWR/4X10 PT/ 4,0M/S7	2905522	1
	10 m	VIP-PA-PWR/4X10 PT/10,0M/S7	2905526	1



Front adapter with punched-on connectors
for 20 plug-in modular terminal blocks

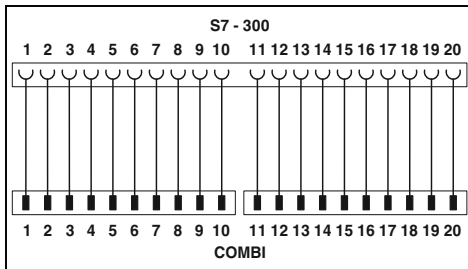

Technical data

250 V AC/DC
250 V / 250 V

6 A (per single wire at 40°C)
4 A (per single wire at 60°C)
20 A (per cable at 40°C)
16 A (per cable at 60°C)

39 Ω/km
AWG 21 / 0.5 mm²
16 / Cu uninsulated
9 mm
-20°C ... 60°C
DIN EN 50178, IEC 60664
Plug connection
COMBICON connectors

Ordering data

Type	Order No.	Pcs./Pkt.
VIP-PA-PWR/2X10COMBI/ 1,0M/S7	2904714	1
VIP-PA-PWR/2X10COMBI/ 1,5M/S7	2904715	1
VIP-PA-PWR/2X10COMBI/ 2,0M/S7	2904716	1
VIP-PA-PWR/2X10COMBI/ 2,5M/S7	2904717	1
VIP-PA-PWR/2X10COMBI/ 3,0M/S7	2904718	1
VIP-PA-PWR/2X10COMBI/ 4,0M/S7	2904719	1
VIP-PA-PWR/2X10COMBI/10,0M/S7	2904723	1
VIP-PA-PWR/2X10 PT/ 1,0M/S7	2905529	1
VIP-PA-PWR/2X10 PT/ 1,5M/S7	2905531	1
VIP-PA-PWR/2X10 PT/ 2,0M/S7	2905532	1
VIP-PA-PWR/2X10 PT/ 2,5M/S7	2905533	1
VIP-PA-PWR/2X10 PT/ 3,0M/S7	2905534	1
VIP-PA-PWR/2X10 PT/ 4,0M/S7	2905535	1
VIP-PA-PWR/2X10 PT/10,0M/S7	2905539	1

Controller-specific system cabling

VIP – power cabling

Universal front adapters for Siemens SIMATIC® S7-300

Four versions are available:

- Connection of 40-pos. modules via 40 individual wires in rope structure (not assembled), PVC insulation
- Connection of 20-pos. modules via 20 individual wires in rope structure (not assembled), PVC insulation
- Connection of 40-pos. modules via 40 individual wires in rope structure (not assembled), insulation made from halogen-free material
- Connection of 20-pos. modules via 20 individual wires in rope structure (not assembled), insulation made from halogen-free material

The front adapters have the following features:

- Can be screwed on/snapped in with the I/O module
- Suitable for all common S7-300 modules, up to max. 250 V AC/DC, 6 A
- Universal 1:1 connection
- Numerically marked wires

Additional accessories, such as connection terminal blocks, can be found in Catalog 1 “Terminal blocks” or at phoenixcontact.net/products.



Front adapter with 40 open cable ends, PVC insulation

ERIC

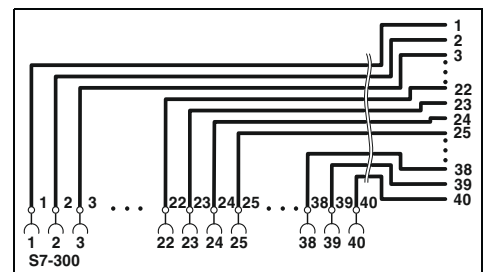

Technical data

Maximum permissible operating voltage
Maximum permissible current

250 V AC/DC
6 A (per single wire at 40°C)
4 A (per single wire at 60°C)
750 mA (per single wire at 75°C)
20 A (per cable at 40°C)
16 A (per cable at 60°C)

Maximum permissible total current

39 Ω/km
AWG 21 / 0.5 mm²
16 / Cu uninsulated
13 mm

Maximum conductor resistance
Conductor cross section
Conductor structure: stranded wires / material
Outside diameter
Ambient temperature range
Standards/regulations
Connection method

-20°C ... 60°C
DIN EN 50178, IEC 60664
Plug connection
Open cable end

Controller level
Field level

Ordering data

Description	Cable length	Type	Order No.	Pcs./Pkt.
Front adapter with 40 open cable ends for connecting 40-pos. modules	1 m	VIP-PA-PWR/40XOE/ 1,0M/S7	2904731	1
	2 m	VIP-PA-PWR/40XOE/ 2,0M/S7	2904732	1
	3 m	VIP-PA-PWR/40XOE/ 3,0M/S7	2904733	1
	4 m	VIP-PA-PWR/40XOE/ 4,0M/S7	2904734	1
	10 m	VIP-PA-PWR/40XOE/10,0M/S7	2904737	1
Front adapter with 20 open cable ends for connecting 20-pos. modules	1 m			
	2 m			
	3 m			
	4 m			
	10 m			



Front adapter with 20 open cable ends,
PVC insulation



Front adapter with 40 open cable ends,
halogen-free



Front adapter with 20 open cable ends,
halogen-free

ERC

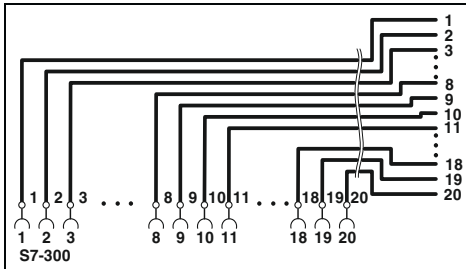

Technical data

250 V AC/DC
6 A (per single wire at 40°C)
4 A (per single wire at 60°C)
750 mA (per single wire at 75°C)
20 A (per cable at 40°C)
16 A (per cable at 60°C)
39 Ω/km
AWG 21 / 0.5 mm²
16 / Cu uninsulated
9 mm
-20°C ... 60°C
DIN EN 50178, IEC 60664
Plug connection
Open cable end

Ordering data

Type	Order No.	Pcs./Pkt.
VIP-PA-PWR/20XOE/ 1,0M/S7	2904724	1
VIP-PA-PWR/20XOE/ 2,0M/S7	2904725	1
VIP-PA-PWR/20XOE/ 3,0M/S7	2904726	1
VIP-PA-PWR/20XOE/ 4,0M/S7	2904727	1
VIP-PA-PWR/20XOE/10,0M/S7	2904730	1

ERC

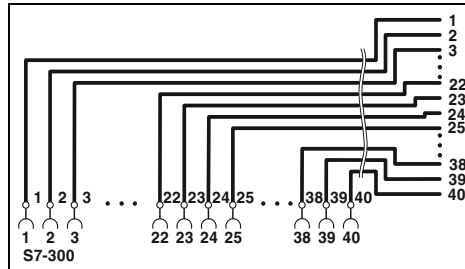

Technical data

250 V AC/DC
6 A (per single wire at 40°C)
4 A (per single wire at 60°C)
750 mA (per single wire at 75°C)
20 A (per cable at 40°C)
16 A (per cable at 60°C)
39 Ω/km
AWG 21 / 0.5 mm²
16 / Cu uninsulated
13 mm
-20°C ... 60°C
DIN EN 50178, IEC 60664
Plug connection
Open cable end

Ordering data

Type	Order No.	Pcs./Pkt.
VIP-PA-PWR/40XOE/HF/ 1,0M/S7	2908909	1
VIP-PA-PWR/40XOE/HF/ 2,0M/S7	2908908	1
VIP-PA-PWR/40XOE/HF/ 3,0M/S7	2908907	1
VIP-PA-PWR/40XOE/HF/ 4,0M/S7	2908905	1
VIP-PA-PWR/40XOE/HF/10,0M/S7	2908902	1

ERC



Technical data

250 V AC/DC
6 A (per single wire at 40°C)
4 A (per single wire at 60°C)
750 mA (per single wire at 75°C)
20 A (per cable at 40°C)
16 A (per cable at 60°C)
39 Ω/km
AWG 21 / 0.5 mm²
16 / Cu uninsulated
9 mm
-20°C ... 60°C
DIN EN 50178, IEC 60664
Plug connection
Open cable end

Ordering data

Type	Order No.	Pcs./Pkt.
VIP-PA-PWR/20XOE/HF/ 1,0M/S7	2908916	1
VIP-PA-PWR/20XOE/HF/ 2,0M/S7	2908915	1
VIP-PA-PWR/20XOE/HF/ 3,0M/S7	2908914	1
VIP-PA-PWR/20XOE/HF/ 4,0M/S7	2908913	1
VIP-PA-PWR/20XOE/HF/10,0M/S7	2908910	1

System cabling for controllers

Controller-specific system cabling

VIP – VARIOFACE Professional Front adapters for Siemens SIMATIC® S7-300

Three connection options are available:

- Transfer of max. 32 channels via two 50-pos. system cables (32-channel cards or this design)
- Transfer of 4 x 8 channels via two 14-pos. system cables (32-channel cards or their type)
- Transfer of 2 x 8 channels via two 14-pos. system cables (16-channel cards or their type)

The front adapters have the following features:

- Can be screwed with I/O module
- Voltage supply via terminal blocks with spring-cage double connection
- Encapsulated IDC/FLK socket strips for module side
Special lengths are configured using separate order numbers.

Ordering example:

A front adapter with a connected 50-pos. system cable (32-channel cards), 12.75 m in length:

1 pcs. 2900885/12,75

Web code for the online configurator

i Your web code: **#0007**

Notes:
The following modules cannot be coupled due to the larger outer contour of the molded connectors: UM 45-FLK14/ 8IM/ZFKDS/PLC, 2965211 UM 45-FLK50/32IM/ZFKDS/PLC, 2965224 UM 45-8RM/MR-G24/1/PLC, 2962900 UM 45-16RM/MR-G24/1/PLC, 2962913
Controller-specific modules from page 506
Digital modules such as VIP-2/SC/FLK14/PLC (2315214) can be found starting on page 516
Relay connections using PLC-V8/FLK14/OUT (2295554) and the like can be found starting on page 427

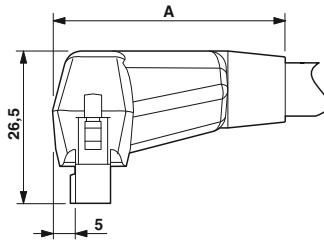

	A
...FLK14...	37
...FLK50...	42



Front adapter with system cable
1 x 32 channels can be connected

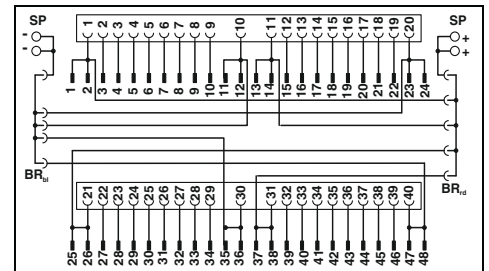

Technical data

Maximum permissible operating voltage
Maximum permissible operating voltage UL / CSA

25 V AC / 60 V DC
50 V / -

Maximum permissible current

1 A (per path)
8 A (separate power supply)

Maximum conductor resistance
Conductor cross section
Conductor structure: stranded wires / material
Outside diameter
Ambient temperature range
Standards/regulations
Connection method

0.16 Ω/m
AWG 26 / 0.14 mm²
7 / Cu tin-plated
10.3 mm
-20°C ... 50°C
IEC 60664, DIN EN 50178

Connection data solid/stranded/AWG

Control side
Field level
Plug connection
IDC/FLK socket strip
0.2 ... 2.5 mm² / 0.2 ... 2.5 mm² / 24 - 14

Ordering data

Description	Cable length	Type	Order No.	Pcs./Pkt.
VIP – VARIOFACE front adapter, with connected system cables for SIMATIC® S7-300				
	0.5 m	VIP-PA-FLK50/ 0,5M/S7	2322443	1
	1 m	VIP-PA-FLK50/ 1,0M/S7	2322456	1
	1.5 m	VIP-PA-FLK50/ 1,5M/S7	2322469	1
	2 m	VIP-PA-FLK50/ 2,0M/S7	2321800	1
	2.5 m	VIP-PA-FLK50/ 2,5M/S7	2322472	1
	3 m	VIP-PA-FLK50/ 3,0M/S7	2322485	1
	4 m	VIP-PA-FLK50/ 4,0M/S7	2322498	1
	10 m	VIP-PA-FLK50/10,0M/S7	2322540	1
VIP VARIOFACE front adapter, as above, in variable lengths				
		VIP-PA-FLK50-S7/...	2900885	1



Front adapter with system cable
4 x 8 channels can be connected



Front adapter with system cable
2 x 8 channels can be connected

Front adapters for 32-channel cards of the SIMATIC® S7-300

Card type	VIP-PA-FLK50/...M/S7
Digital input	6ES7 321-1BL00-0AA0
Digital output	6ES7 322-1BL00-0AA0
Digital input/output	6ES7 323-1BL00-0AA0
Analog input	6ES7 331-7PF01-0AB0* 6ES7 331-7PF11-0AB0* 6ES7 331-7NF00-0AB0* 6ES7 331-7NF10-0AB0* 6ES7 331-1KF01-0AB0*
Analog output	6ES7 332-5HF00-0AB0*
CPU	312C, 313C, 314C, 313C-2PIP 313C-2DP, 314C-2DP
Other modules	6ES7 350-2AH01-0AE0* 6ES7 357-4AH01-0AE0*

Card type	VIP-PA-FLK50/4X14/...M/S7
Digital input	6ES7 321-1BL00-0AA0
Digital output	6ES7 322-1BL00-0AA0
Digital input/output	6ES7 323-1BL00-0AA0
CPU	313C, 314C, 313C-2PIP 313C-2DP, 314C-2DP

* Only in conjunction with
VIP-2/SC/FLK50 (1-40)/S7, Order No.: 2315243,
VIP-2/PT/FLK50 (1-40)/S7, Order No.: 2903804,
FLKM 50/KDS3-MT/PPA/S7-300, Order No.: 2304490.
All bridges (BR) on the adapter must be removed.

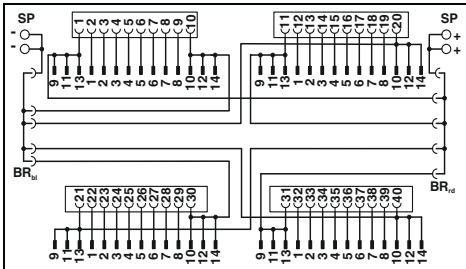

Technical data

25 V AC / 60 V DC
50 V / -
1 A (per path)
8 A (separate power supply)
0.16 Ω/m
AWG 26 / 0.14 mm²
7 / Cu tin-plated
6.4 mm
-20°C ... 50°C
IEC 60664, DIN EN 50178
Plug connection
IDC/FLK socket strip
0.2 ... 2.5 mm² / 0.2 ... 2.5 mm² / 24 - 14

Ordering data

Type	Order No.	Pcs./Pkt.
VIP-PA-FLK50/4X14/ 0,5M/S7	2322553	1
VIP-PA-FLK50/4X14/ 1,0M/S7	2322566	1
VIP-PA-FLK50/4X14/ 1,5M/S7	2322579	1
VIP-PA-FLK50/4X14/ 2,0M/S7	2321910	1
VIP-PA-FLK50/4X14/ 2,5M/S7	2322582	1
VIP-PA-FLK50/4X14/ 3,0M/S7	2322595	1
VIP-PA-FLK50/4X14/ 4,0M/S7	2322605	1
VIP-PA-FLK50/4X14/10,0M/S7	2322650	1
VIP-PA-FLK50-4X14-S7/...	2900886	1

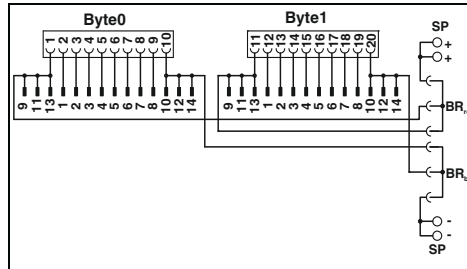

Technical data

25 V AC / 60 V DC
50 V / -
1 A (per path)
8 A (separate power supply)
0.16 Ω/m
AWG 26 / 0.14 mm²
7 / Cu tin-plated
6.4 mm
-20°C ... 50°C
IEC 60664, DIN EN 50178
Plug connection
IDC/FLK socket strip
0.2 ... 2.5 mm² / 0.2 ... 2.5 mm² / 24 - 14

Ordering data

Type	Order No.	Pcs./Pkt.
VIP-PA-FLK14/ 0,5M/S7	2322663	1
VIP-PA-FLK14/ 1,0M/S7	2322676	1
VIP-PA-FLK14/ 1,5M/S7	2322689	1
VIP-PA-FLK14/ 2,0M/S7	2321790	1
VIP-PA-FLK14/ 2,5M/S7	2322692	1
VIP-PA-FLK14/ 3,0M/S7	2322702	1
VIP-PA-FLK14/ 4,0M/S7	2322715	1
VIP-PA-FLK14/10,0M/S7	2322760	1
VIP-PA-FLK14-S7/...	2900887	1

Front adapters for 16-channel cards of SIMATIC® S7-300

Card type	VIP-PA-FLK14/...M/S7
Digital input	6ES7 321-1BH02-0AA0 6ES7 321-1BH10-0AA0 6ES7 321-1BH50-0AA0* 6ES7 321-7BH01-0AB0*
Digital output	6ES7 322-1BH01-0AA0 6ES7 322-1BH10-0AA0 6ES7 322-8BF00-0AB0*
Digital input/output	6ES7 323-1BH01-0AA0
Analog input	6ES7 331-7KF02-0AB0* 6ES7 331-7HF01-0AB0* 6ES7 331-7KB02-0AB0* 6ES7 331-7TF01-0AB0*
Analog output	6ES7 332-5HD01-0AB0* 6ES7 332-5HB01-0AB0* 6ES7 332-7ND02-0AB0*
Analog input/output	6ES7 334-0CE01-0AA0* 6ES7 334-0KE00-0AB0* 6ES7 335-7HG01-0AB0*
Other modules	6ES7 338-4BC01-0AB0* 6ES7 350-1AH03-0AE0* 6ES7 351-1AH01-0AE0* 6ES7 352-1AH02-0AE0* 6ES7 353-1AH01-0AE0* 6ES7 354-1AH01-0AE0* 6ES7 355-0VH10-0AE0* 6ES7 355-1VH10-0AE0*

* Only in conjunction with
VIP-2/SC/2FLK14 (1-20)/S7, Order No.: 2315230
VIP-2/PT/2FLK14 (1-20)/S7, Order No.: 2903802
FLKM-2FLK14/KDS 3-MT/PPA/S7, Order No.: 2295062
All bridges (BR) on the adapter must be disconnected.

Note:
The front adapters are non-isolated on delivery.
Electrical isolation can be achieved by removing the bridges (in groups of 8).

Explanation:
— IDC/FLK strip
— Connection to I/O card

SP: Separate feed-in terminals
BR_{bl}: Blue plug-in bridge
BR_{rd}: Red plug-in bridge

System cabling for controllers

Controller-specific system cabling

Siemens SIMATIC® S7-300 Front adapters

I/O modules with 32 channels or with this design

There are two connection possibilities available:

- Transfer of max. 32 channels over one 50-position system cable
- Transmission of 4 x 8 channels over four 14-position system cables

Perfectly-fitting VARIOFACE termination boards with a variety of functions and connection possibilities round off this system concept.

Web code for the online configurator

i Your web code: #0007

Notes:
Controller-specific modules from page 506
Digital modules such as VIP-2/SC/FLK14/PLC (2315214) can be found starting on page 516
Relay connections using PLC-V8/FLK14/OUT (2295554) and the like can be found starting on page 427
For system cables, see page 536

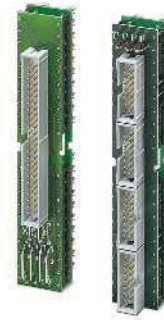

Front adapter for SIMATIC® S7-300, I/O cards with max. 32 channels



Technical data

Maximum permissible operating voltage	25 V AC / 60 V DC
Maximum permissible operating voltage UL / CSA	125 V / -
Maximum permissible current	1 A (per path) 8 A (per connection, supply via separate power supply (2.8 x 0.8 mm))
Maximum permissible total current	2 A (per Byte, for supply via connector) 8 A (during supply via a separate bridged power supply)
Ambient temperature (operation)	-20°C ... 50°C
Ambient temperature (storage/transport)	-20°C ... 70°C
Standards/regulations	IEC 60664 / DIN EN 50178
Connection method	IDC/FLK pin strip

Front adapters for 32-channel cards of the SIMATIC® S7-300

Card type	FLKM 50-PA-S300
Digital input	6ES7 321-1BL00-0AA0
Digital output	6ES7 322-1BL00-0AA0
Digital input/output	6ES7 323-1BL00-0AA0
Analog input	6ES7 331-7PF01-0AB0* 6ES7 331-7PF11-0AB0* 6ES7 331-7NF00-0AB0* 6ES7 331-7NF10-0AB0* 6ES7 331-1KF01-0AB0*
Analog output	6ES7 332-5HF00-0AB0*
CPU	312C, 313C, 314C, 313C-2PiP 313C-2DP, 314C-2DP
Other modules	6ES7 350-2AH01-0AE0* 6ES7 357-4AH01-0AE0*

Description	No. of pos.
VARIOFACE front adapters, for SIMATIC® S7-300	
- 1 x 32 channels can be connected	50
- 4 x 8 channels can be connected	14

Card type	FLKM 50/4-FLK14/PA-S300
Digital input	6ES7 321-1BL00-0AA0
Digital output	6ES7 322-1BL00-0AA0
Digital input/output	6ES7 323-1BL00-0AA0
CPU	313C, 314C, 313C-2PiP 313C-2DP, 314C-2DP

* Only in conjunction with
VIP-2/SC/FLK50(1-40)/S7, Order No.: 2315243,
VIP-2/PT/FLK50(1-40)/S7, Order No.: 2903804,
FLKM 50/KDS3-MT/PPA/S7-300, Order No.: 2304490.
All wire bridges (DR) on the adapter must be disconnected!
There must be no voltage supply at the front adapter
(flowing via the slip-on connections)!

Note:
The front adapters are non-isolated on delivery.
Electrical isolation is achieved by removing the wire bridges
(in groups of 8).

Explanation:
 IDC/FLK strip
 Connection to I/O card
 Screw terminal blocks for separate supply

Ordering data

Type	Order No.	Pcs./Pkt.
FLKM 50-PA-S300	2294445	1
FLKM 50/4-FLK14/PA-S300	2296281	1

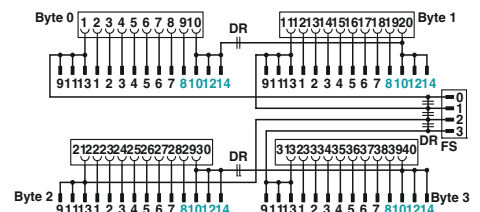
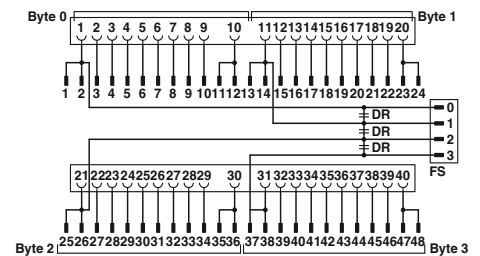

Siemens SIMATIC® S7-300

Front adapters

I/O modules with 16 channels or with this design

– Up to 2 x 8 channels are connected via two 14-position system cables.

Perfectly-fitting VARIOFACE termination boards with a variety of functions and connection possibilities round off this system concept.

Web code for the online configurator

i Your web code: **#0007**

Notes:
Controller-specific modules from page 506
Digital modules such as VIP-2/SC/2FLK14 (1-20)/S7 (2315230) can be found starting on page 507
Relay connections using PLC-V8/FLK14/OUT (2295554) and the like can be found starting on page 427
For system cables, see page 536



Front adapter for SIMATIC® S7-300, I/O cards with max. 16 channels



Technical data

Maximum permissible operating voltage	25 V AC / 60 V DC
Maximum permissible operating voltage UL / CSA	125 V / -
Maximum permissible current	1 A (per path) 8 A (per connection, supply via separate power supply (2.8 x 0.8 mm))
Maximum permissible total current	2 A (per Byte, for supply via connector) 8 A (during supply via a separate bridged power supply)
Ambient temperature (operation)	-20°C ... 50°C
Ambient temperature (storage/transport)	-20°C ... 70°C
Standards/regulations	IEC 60664 / DIN EN 50178
Connection method	IDC/FLK pin strip

Front adapters for 16-channel cards of the SIMATIC® S7-300

Card type	FLKM 14-PA-S300
Digital input	6ES7 321-1BH02-0AA0 6ES7 321-1BH10-0AA0 6ES7 321-1BH50-0AA0* 6ES7 321-7BH01-0AB0*
Digital output	6ES7 322-1BH01-0AA0 6ES7 322-1BH10-0AA0 6ES7 322-8BF00-0AB0*
Digital input/output	6ES7 323-1BH01-0AA0
Analog input	6ES7 331-7KF02-0AB0* 6ES7 331-7HF01-0AB0* 6ES7 331-7KB02-0AB0* 6ES7 331-7TF01-0AB0*
Analog output	6ES7 332-5HD01-0AB0* 6ES7 332-5HB01-0AB0* 6ES7 332-7ND02-0AB0*
Analog input/output	6ES7 334-0CE01-0AA0* 6ES7 334-0KE00-0AB0* 6ES7 335-7HG01-0AB0*
Other modules	6ES7 338-4BC01-0AB0* 6ES7 350-1AH03-0AE0* 6ES7 351-1AH01-0AE0* 6ES7 352-1AH02-0AE0* 6ES7 353-1AH01-0AE0* 6ES7 354-1AH01-0AE0* 6ES7 355-0VH10-0AE0* 6ES7 355-1VH10-0AE0*

* Only in conjunction with
VIP-2/SC/2FLK14 (1-20)/S7, Order No.: 2315230
VIP-2/PT/2FLK14 (1-20)/S7, Order No.: 2903802
FLKM-2FLK14/KDS 3-MT/PPA/S7, Order No.: 2295062
All wire bridges (DR) on the adapter must be disconnected.
There must be no voltage supply at the front adapter (flowing via the slip-on connections)!

Note:

The front adapters are non-isolated on delivery.
Electrical isolation is achieved by removing the wire bridges (in groups of 8).

Explanation:

- IDC/FLK strip
- Connection to I/O card
- Screw terminal blocks for separate supply

Description	No. of pos.
VARIOFACE front adapters, for SIMATIC® S7-300	
- 2 x 8 channels can be connected	14

Ordering data

Type	Order No.	Pcs./Pkt.
FLKM 14-PA-S300	2299770	1

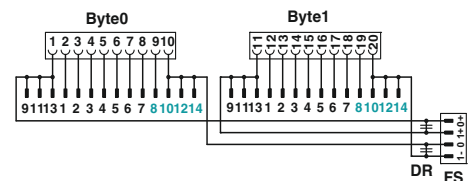

Connection scheme FLKM 14-PA-S300

Controller-specific system cabling

Siemens SIMATIC® S7-300 System cables for 64-channel I/O cards

These system cables are plugged onto the 64-channel (2x32) I/O cards that are directly connected using connectors.

CABLE-FCN40/1X50/...

- Signal transmission of 1x32 channels
- System cable: 40-pos. connector to 50-pos. IDC/FLK socket strip

CABLE-FCN40/4X14/...

- Signal transmission of 4x8 channels
- Splitting cable: 40-pos. connector to four 14-pos. IDC/FLK socket strips

Notes:

Digital modules such as VIP-2/SC/FLK14/PLC (2315214) can be found starting on page 516

Relay connections using PLC-V8/FLK14/OUT (2295554) and the like can be found starting on page 427



System cable



Technical data

Maximum permissible operating voltage	25 V AC / 60 V DC
Maximum permissible operating voltage UL / CSA	125 V / -
Maximum permissible current carrying capacity per path	1 A
Maximum conductor resistance	0.16 Ω/m
Ambient temperature (operation)	-20°C ... 50°C
Conductor cross section	AWG 26 / 0.14 mm ²
Conductor structure: stranded wires / material	7 / Cu tin-plated

Ordering data

Description	No. of pos.	Cable length	Type	Order No.	Pcs./Pkt.
Round cable, for output module 6ES7 322-1BP00-0AA0 and 6ES7 322-1BP50-0AA0 (two cables per module)					
	40	0.5 m	CABLE-FCN40/1X50/ 0,5M/S7-OUT	2321017	1
	40	1 m	CABLE-FCN40/1X50/ 1,0M/S7-OUT	2321020	1
	40	2 m	CABLE-FCN40/1X50/ 2,0M/S7-OUT	2321033	1
	40	3 m	CABLE-FCN40/1X50/ 3,0M/S7-OUT	2321046	1
	40	4 m	CABLE-FCN40/1X50/ 4,0M/S7-OUT	2321059	1
	40	6 m	CABLE-FCN40/1X50/ 6,0M/S7-OUT	2321062	1
	40	8 m	CABLE-FCN40/1X50/ 8,0M/S7-OUT	2321075	1
	40	10 m	CABLE-FCN40/1X50/10,0M/S7-OUT	2321088	1
Round cable, for input module 6ES7 321-1BP00-0AA0 (two cables per module). Plus-reading operation (sinking mode) of the module					
	40	0.5 m	CABLE-FCN40/1X50/ 0,5M/S7-IN	2321091	1
	40	1 m	CABLE-FCN40/1X50/ 1,0M/S7-IN	2321101	1
	40	2 m	CABLE-FCN40/1X50/ 2,0M/S7-IN	2321114	1
	40	3 m	CABLE-FCN40/1X50/ 3,0M/S7-IN	2321127	1
	40	4 m	CABLE-FCN40/1X50/ 4,0M/S7-IN	2321130	1
	40	6 m	CABLE-FCN40/1X50/ 6,0M/S7-IN	2321143	1
	40	8 m	CABLE-FCN40/1X50/ 8,0M/S7-IN	2321156	1
	40	10 m	CABLE-FCN40/1X50/10,0M/S7-IN	2321169	1



Splitting cable



Technical data

25 V AC / 60 V DC
125 V / -

1 A

0,16 Ω/m
-20°C ... 50°C
AWG 26 / 0,14 mm²
7 / Cu tin-plated

Ordering data

Type	Order No.	Pcs./Pkt.
CABLE-FCN40/4X14/ 0,5M/S7-OUT	2321172	1
CABLE-FCN40/4X14/ 1,0M/S7-OUT	2321185	1
CABLE-FCN40/4X14/ 2,0M/S7-OUT	2321198	1
CABLE-FCN40/4X14/ 3,0M/S7-OUT	2321208	1
CABLE-FCN40/4X14/ 4,0M/S7-OUT	2321211	1
CABLE-FCN40/4X14/ 6,0M/S7-OUT	2321224	1
CABLE-FCN40/4X14/ 8,0M/S7-OUT	2321237	1
CABLE-FCN40/4X14/10,0M/S7-OUT	2321240	1
CABLE-FCN40/4X14/ 0,5M/S7-IN	2321253	1
CABLE-FCN40/4X14/ 1,0M/S7-IN	2321266	1
CABLE-FCN40/4X14/ 2,0M/S7-IN	2321279	1
CABLE-FCN40/4X14/ 3,0M/S7-IN	2321282	1
CABLE-FCN40/4X14/ 4,0M/S7-IN	2321295	1
CABLE-FCN40/4X14/ 6,0M/S7-IN	2321305	1
CABLE-FCN40/4X14/ 8,0M/S7-IN	2321318	1
CABLE-FCN40/4X14/10,0M/S7-IN	2321321	1

System cabling for controllers

Controller-specific system cabling

Siemens SIMATIC® S7-300 Interface modules

These VIP – VARIOFACE Professional modules are used in combination with 50-pos. system cables and the relevant front adapters for S7-300.

Features:

- One 50-pos. IDC/FLK pin strip
- Numerical marking (1-40)
- Specifically for SIMATIC® S7-300

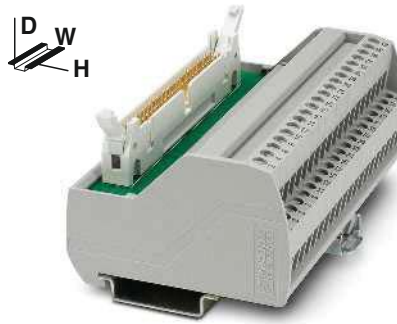

Passive interface module for SIMATIC® S7-300

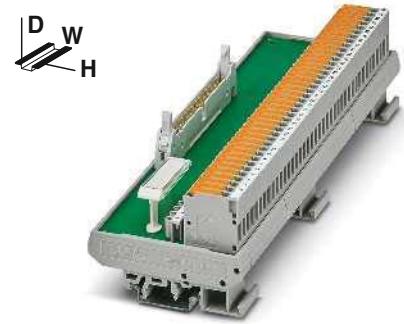

Passive termination board for SIMATIC® S7-300 with knife disconnect terminal blocks



Maximum permissible operating voltage
Maximum permissible operating voltage UL / CSA

Maximum permissible current (per branch)
Ambient temperature (operation)

Mounting position
Standards/regulations

Connection method

Screw connection rigid / flexible / AWG
Push-in connection rigid / flexible / AWG

Dimensions

Field level
Controller level

Screw connection

IDC/FLK pin strip

0.2 ... 4 mm² / 0.2 ... 2.5 mm² / 24 - 12
0.14 ... 2.5 mm² / 0.14 ... 2.5 mm² / 26 - 14

H / D

65.5 mm / 56 mm

Technical data

VIP-2/SC/FLK50 (1-40) /S7
25 V AC / 60 V DC
125 V / 125 V

VIP-2/PT/FLK50 (1-40) /S7
25 V AC / 60 V DC
125 V / 125 V

1 A
-20°C ... 50°C

Any
IEC 60664, DIN EN 50178

Screw connection

IDC/FLK pin strip
0.2 ... 4 mm² / 0.2 ... 2.5 mm² / 24 - 12
0.14 ... 2.5 mm² / 0.14 ... 2.5 mm² / 26 - 14

H / D

65.5 mm / 56 mm

Ordering data

Type	Order No.	Pcs./Pkt.
VIP-2/SC/FLK50 (1-40) /S7	2315243	1
VIP-2/PT/FLK50 (1-40) /S7	2903804	1

Technical data

FLKM 50/KDS3-MT/PPA/S7-300
60 V DC
24 V / -

1 A
-20°C ... 50°C

Any
DIN EN 50178, IEC 60664

Screw connection with disconnect knife

IDC/FLK pin strip
0.2 ... 4 mm² / 0.2 ... 2.5 mm² / 24 - 12
- ... - / - ... - / -

77 mm / 61 mm

- / -

Ordering data

Type	Order No.	Pcs./Pkt.
FLKM 50/KDS3-MT/PPA/S7-300	2304490	1

Description	No. of pos.	Module width W
VARIOFACE interface module , with SIMATIC® S7-300-specific marking from 1 to 40		
- with screw connection	50	106.1 mm
- with Push-in connection	50	107.9 mm
VARIOFACE termination board , with SIMATIC® S7-300-specific marking from 1 to 40, knife disconnect terminal blocks and test sockets for field and system side		
	50	214 mm

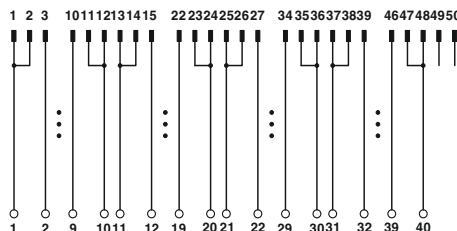

Connection scheme VIP-2/.../FLK50 (1-40) /S7

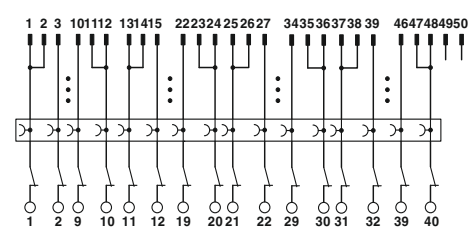

Connection scheme FLKM 50/KDS3-MT/PPA/S7-300

Siemens SIMATIC® S7-300 Interface modules

These VARIOFACE termination boards are used in combination with two 14-pos. system cables and the corresponding front adapters for SIMATIC® S7-300.

Features:

- Two 14-pos. IDC/FLK pin strips
- Numerical marking (1-20)
- Specifically for SIMATIC® S7-300

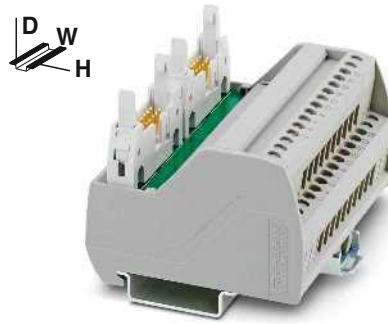

Passive interface module
for SIMATIC® S7-300

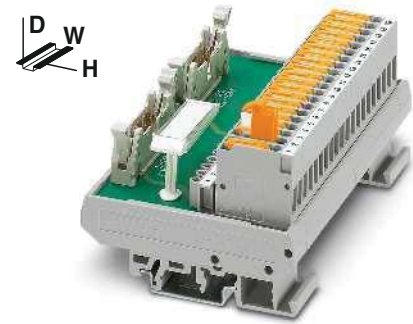

Passive termination board
for SIMATIC® S7-300
with knife disconnect terminal blocks



		Technical data	
Maximum permissible operating voltage		VIP-2/SC/2FLK14 (1-20) /S7 25 V AC / 60 V DC	VIP-2/PT/2FLK14 (1-20) /S7 25 V AC / 60 V DC
Maximum permissible operating voltage UL / CSA		125 V / 125 V	125 V / 125 V
Maximum permissible current (per branch)		1 A	1 A
Ambient temperature (operation)		-20°C ... 50°C	-20°C ... 50°C
Mounting position		Any	Any
Standards/regulations		IEC 60664, DIN EN 50178	
Connection method	Field level	Screw connection	Push-in connection
	Controller level	IDC/FLK pin strip	IDC/FLK pin strip
Screw connection rigid / flexible / AWG		0.2 ... 4 mm ² / 0.2 ... 2.5 mm ² / 24 - 12	
Push-in connection rigid / flexible / AWG		0.14 ... 2.5 mm ² / 0.14 ... 2.5 mm ² / 26 - 14	
Dimensions	H / D	65.5 mm / 56 mm	

		Technical data	
		FLKM-2FLK14/KDS3-MT/PPA/S7	
		60 V DC	
		24 V / -	
		1 A	
		-20°C ... 50°C	
		Any	
		DIN EN 50178, IEC 60664	
		Screw connection with disconnect knife	
		IDC/FLK pin strip	
		0.2 ... 4 mm ² / 0.2 ... 2.5 mm ² / 24 - 12	
		- ... / - ... / -	
		77 mm / 61 mm	

			Ordering data		
Description	No. of pos.	Module width W	Type	Order No.	Pcs./Pkt.
VARIOFACE interface module , with SIMATIC® S7-300-specific marking from 1 to 20					
- with screw connection	14	80.6 mm	VIP-2/SC/2FLK14 (1-20) /S7	2315230	1
- with Push-in connection	14	82.5 mm	VIP-2/PT/2FLK14 (1-20) /S7	2903802	1
VARIOFACE termination board , for SIMATIC® S7-300 with SIMATIC-specific marking (1-20), knife disconnect terminal blocks and test sockets for field and system side					
	14	113 mm			

			Ordering data		
Type	Order No.	Pcs./Pkt.	Type	Order No.	Pcs./Pkt.
FLKM-2FLK14/KDS3-MT/PPA/S7	2295062	1			

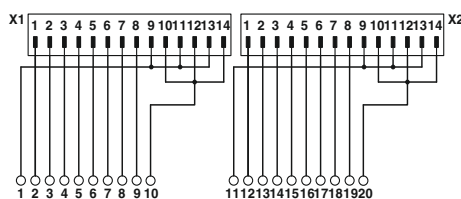

Connection scheme: VIP-2/.../2FLK14 (1-20) /S7

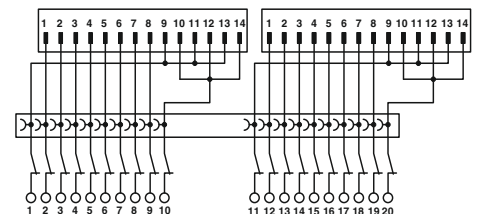

Connection scheme FLKM-2FLK14/KDS3-MT/PPA/S7

System cabling for controllers

Controller-specific system cabling

Siemens SIMATIC® S7-400

Front adapters

Digital I/O modules

– Transmission of a maximum of 32 channels is done via a 50-pos. system cable. As an alternative, the 32 channels can be divided across 4 x 8 channels with a splitter cable. Perfectly-fitting VARIOFACE termination boards with a variety of functions and connection possibilities round off this system concept.

Web code for the online configurator

i Your web code: **#0007**

Notes:
Controller-specific modules page 510
Digital modules such as VIP-2/SC/FLK14/PLC (2315214) can be found starting on page 516
Relay connections using PLC-V8/FLK14/OUT (2295554) and the like can be found starting on page 427
For system cables, see page 536



Front adapter for SIMATIC® S7-400 digital I/O cards



Technical data

Maximum permissible operating voltage	25 V AC / 60 V DC
Maximum permissible operating voltage UL / CSA	125 V / -
Maximum permissible current	1 A (per path) 8 A (per connection, supply via separate power supply)
Maximum permissible total current	2 A (per Byte, for supply via connector) 8 A (during supply via a separate bridged power supply)
Ambient temperature (operation)	-20°C ... 50°C
Ambient temperature (storage/transport)	-20°C ... 70°C
Mounting position	Any
Standards/regulations	IEC 60664 / DIN EN 50178

Front adapter for I/O modules of the Siemens automation devices SIMATIC® S7-400

Card type	FLKM 50-PA-S400
Digital input	6ES7 421-1BL01-0AA0 6ES7 421-7BH01-0AB0* 6ES7 421-7DH00-0AB0*
Digital output	6ES7 422-1BL00-0AA0 6ES7 422-7BL00-0AB0

* Only in conjunction with
VIP-2/SC/FLK50/S7/A-S400, Order No.: [2322359](#)
VIP-2/PT/FLK50/S7/A-S400, Order No.: [2904289](#)
All DR wire bridges on the adapter must be disconnected.

Description	No. of pos.
VARIOFACE front adapter, for - SIMATIC® S7-400, 1 x 32 channels can be connected	50

Ordering data

Type	Order No.	Pcs./Pkt.
FLKM 50-PA-S400	2294500	2

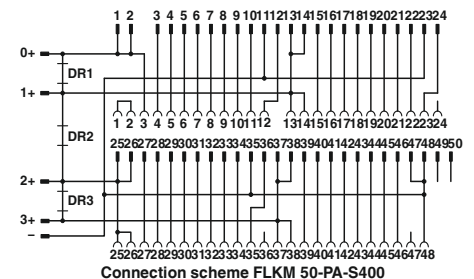

Explanation:

- IDC/FLK strip
- Connection to I/O card
- Screw terminal blocks for separate supply

Siemens SIMATIC® S7-400

Front adapters

Analog I/O modules

– Analog channels are connected via a 50-pos. system cable. The 1:1 adapter connection connects the corresponding termination boards 1:1 here

Web code for the online configurator

i Your web code: #0007

Notes:
Controller-specific VIP-3...FLK50 modules can be found starting on page 549
Controller-specific FLKM 50/KDS 3-MT/PPA/AN/PLC (2291587) modules can be found starting on page 511
For system cables, see page 536



Front adapter for SIMATIC® S7-400 analog I/O cards

ERC

Technical data

FLKM 50-PA-S400(3-48)
 25 V AC / 60 V DC
 1 A (per path)
 -20°C ... 50°C
 -20°C ... 70°C
 Any
 IEC 60664 / DIN EN 50178

Ordering data

Description	No. of pos.	Type	Order No.	Pcs./Pkt.
VARIOFACE front adapter , for - SIMATIC® S7-400, only analog	50	FLKM 50-PA-S400(3-48)	2294908	2

Front adapter for I/O modules of the Siemens automation devices SIMATIC® S7-400

Card type	FLKM 50-PA-S400 (3-48)
Analog input	6ES7 431-0HH00-0AB0** 6ES7 431-1KF00-0AB0** 6ES7 431-1KF10-0AB0** 6ES7 431-1KF20-0AB0** 6ES7 431-7KF00-0AB0** 6ES7 431-7KF10-0AB0** 6ES7 431-7QH00-0AB0**
Analog output	6ES7 432-1HF00-0AB0**

** Only in conjunction with
 VIP-3/SC/FLK50, Order No.: 2315081
 VIP-3/PT/FLK50, Order No.: 2903794
 FLKM 50/KDS 3-MT/PPA/AN/PLC, Order No.: 2291587

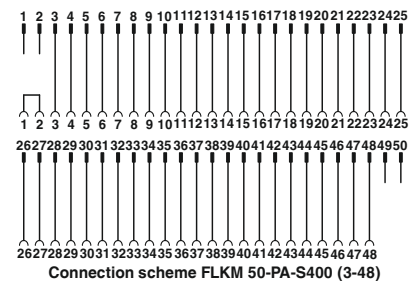

Explanation:

- IDC/FLK strip
- Connection to I/O card
- Screw terminal blocks for separate supply

System cabling for controllers

Controller-specific system cabling

Siemens SIMATIC® S7-400 VIP interface modules

Digital I/O modules

These VIP – VARIOFACE Professional modules are used in combination with 50-pos. system cables and the FLKM 50-PA-S400 front adapter (Order No.: [2294500](#)).

Features:

- One 50-pos. IDC/FLK pin strip
- Numerical marking
- Specifically for SIMATIC® S7-400

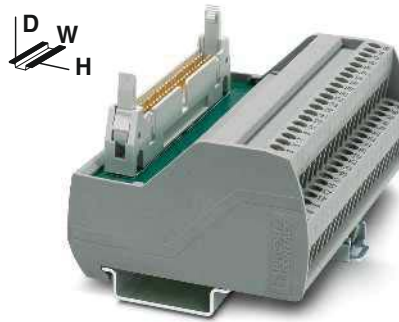

Passive interface modules
for SIMATIC® S7-400
with screw connection

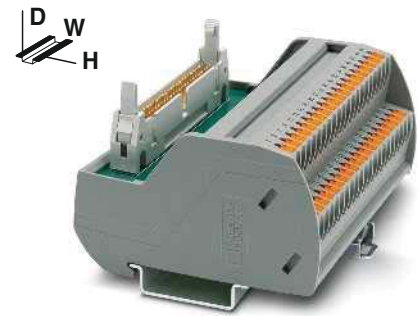

Passive interface modules
for SIMATIC® S7-400
with Push-in connection



Technical data

Maximum permissible operating voltage	25 V AC / 60 V DC
Maximum permissible operating voltage UL / CSA	125 V / -
Maximum permissible current (per branch)	1 A
Ambient temperature (operation)	-20°C ... 50°C
Mounting position	Any
Standards/regulations	IEC 60664, DIN EN 50178
Connection method	Screw connection
	Field level
	Controller level
Connection data solid/stranded/AWG	IDC/FLK pin strip
Dimensions	0.2 ... 4 mm ² / 0.2 ... 2.5 mm ² / 24 - 12
	65.5 mm / 56 mm

Technical data

Maximum permissible operating voltage	25 V AC / 60 V DC
Maximum permissible operating voltage UL / CSA	125 V / 125 V
Maximum permissible current (per branch)	1 A
Ambient temperature (operation)	-20°C ... 50°C
Mounting position	Any
Standards/regulations	IEC 60664, DIN EN 50178
Connection method	Push-in connection
Connection data solid/stranded/AWG	IDC/FLK pin strip
Dimensions	0.14 ... 2.5 mm ² / 0.14 ... 2.5 mm ² / 24 - 12
	72.1 mm / 56 mm

Ordering data

Description	No. of pos.	Module width W	Type	Order No.	Pcs./Pkt.
VARIOFACE interface module , with SIMATIC® S7-400-specific marking from 3 to 48					
- with screw connection	50	106.1 mm	VIP-2/SC/FLK50/S7/A-S400	2322359	1
- with Push-in connection	50	107.9 mm			

Ordering data

Type	Order No.	Pcs./Pkt.
VIP-2/PT/FLK50/S7/A-S400	2904289	1

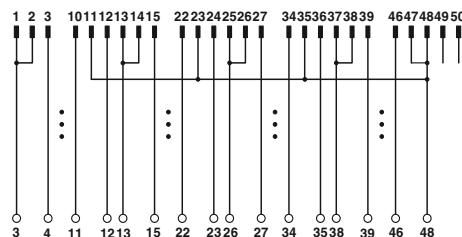

Connection scheme VIP-2/.../FLK50/S7/A-S400

Siemens SIMATIC® S7-400 Interface modules with knife disconnect terminal blocks

Analog I/O modules

This interface module is used in combination with 50-pos. system cables and the FLKM 50-PA-S400(3-48) front adapter (Order No.: [2294908](#)).

Features

- One 50-pos. IDC/FLK pin strip
- Numerical marking (1-50)
- Knife disconnect terminal blocks and test point

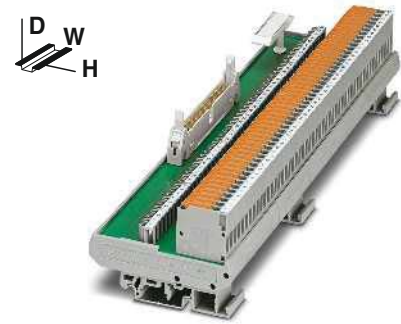

**Passive termination board
for SIMATIC® S7-400
with knife disconnect terminal blocks**



Technical data

Maximum permissible operating voltage	60 V DC
Maximum permissible operating voltage UL / CSA	24 V / -
Maximum permissible current (per branch)	1 A
Ambient temperature (operation)	-20°C ... 50°C
Mounting position	Any
Standards/regulations	DIN EN 50178, IEC 60664
Connection method	Field level Screw connection with disconnect knife
	Controller level IDC/FLK pin strip
Connection data solid/stranded/AWG	0.2 ... 4 mm ² / 0.2 ... 2.5 mm ² / 24 - 12
Dimensions	H / D 77 mm / 61 mm

Ordering data

Description	No. of pos.	Module width W	Type	Order No.	Pcs./Pkt.
VARIOFACE termination board , with marking from 1 to 50, knife disconnect terminal blocks and test sockets for field and system side	50	259 mm	FLKM 50/KDS3-MT/PPA/AN/PLC	2291587	1

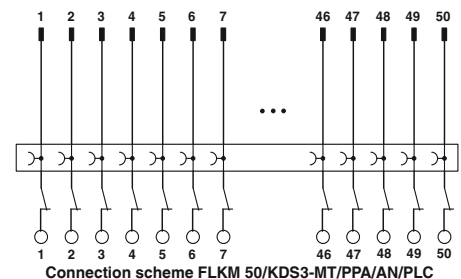

System cabling for controllers

Controller-specific system cabling

Siemens SIMATIC® ET200SP HA Front adapters

The front adapters mean that preassembled system cables can be directly connected to I/O modules. The front adapters plug directly onto the peripheral module terminal blocks. A single plugging operation connects all 36 terminal block connections. Once plugged in, the front adapter and terminal block form a single unit and can no longer be separated.

- Front adapter with D-SUB connector
- Connection of a maximum of 32 channels
- Connection to suitable VARIOFACE interface modules

Notes:

Matching system cable fitted with D-SUB female connector at both ends, see page 571



new

SIMATIC® ET200SP HA front adapter

Technical data

Maximum permissible operating voltage
Maximum permissible current
Maximum permissible total current

25 V AC / 60 V DC
1 A (per path)
2 A (with operating voltage supply via D-SUB male strip)
10 A (with operating voltage feed over screw connection)

Ambient temperature (operation)
Ambient temperature (storage/transport)
Mounting position
Standards/regulations

-20°C ... 50°C
-20°C ... 70°C
any
DIN EN 50178

Ordering data

Description	No. of pos.
VARIOFACE front adapter for ET 200SP HA with one D-SUB male strip for digital 24 V DC and analog peripheral modules, 37-pos.	37

Type	Order No.	Pcs./Pkt.
FLKM-PA-D37/ETHA	1076338	1

Front adapters for SIMATIC® ET 200SP HA I/O modules

Card type	
Digital input	6DL1131-6BH00-0PH1 6DL1131-6TH00-0PH1 6DL1131-6BL00-0PH1
Digital output	6DL1132-6BH00-0PH1 6DL1132-6BL00-0PH1

Card type	FLKM-PA-D37/HW/AN/C300
Analog input	6DL1134-6TH00-0PH1 6DL1134-6JH00-0PH1
Analog output	6DL1135-6TF00-0PH1

Terminal blocks	
TB22-P32 (dark)	6DL1193-6TP00-0BH1
TB22-P32 (light)	6DL1193-6TP00-0DH1
TB45R-P32 (dark)	6DL1193-6TP00-0BM1
TB45R-P32 (light)	6DL1193-6TP00-0DM1

* Once plugged in, the front adapter and terminal block can no longer be separated.

Suitable VARIOFACE interface modules

with system-specific marking:
VIP-2/SC/D37SUB/M/ET200SP-HA, Order No.: 1100967
VIP-2/PT/D37SUB/M/ET200SP-HA, Order No.: 1100964

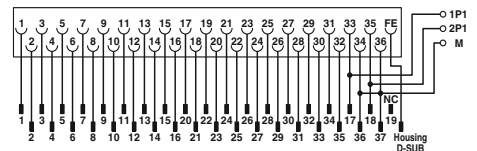

Connection scheme: FLKM-PA-D37/ETHA

Explanation:

- Connectors
- Connection to I/O card
- Screw terminal blocks for separate supply

System cabling for controllers

Controller-specific system cabling

Yokogawa CENTUM VP and ProSafe-RS Front adapters

These front adapters for digital (50-pos.) and analog (40-pos.) I/O modules are connected directly to the modules.

Features:

- Molded connector
- Can be screwed
- Lateral cable outlet of the I/O module
- KS or AKB-compatible connectors on the module side



Shielded



Shielded and halogen-free



Technical data

Maximum permissible operating voltage	30 V DC
Maximum permissible operating voltage UL / CSA	125 V / -
Maximum permissible current	500 mA (per path at 70°C)
Maximum conductor resistance	0.16 Ω/m
Conductor cross section	AWG 26 / 0.14 mm ²
Outside diameter	50 -position: 11 mm 40 -position: 9.8 mm
Ambient temperature range	-20°C ... 70°C



Technical data

Maximum permissible operating voltage	30 V DC
Maximum permissible operating voltage UL / CSA	125 V / -
Maximum permissible current	500 mA (per path at 70°C)
Maximum conductor resistance	-
Conductor cross section	AWG 26 / 0.14 mm ²
Outside diameter	11 mm 9.8 mm
Ambient temperature range	-20°C ... 70°C

Ordering data

Description	Cable length	Type	Order No.	Pcs./Pkt.
Front adapter, for digital I/O modules, 50-pos.				
	1 m	FLK 50-PA/EZ-DR/KS/ 100/YUC	2900991	1
	2 m	FLK 50-PA/EZ-DR/KS/ 200/YUC	2314299	1
	3 m	FLK 50-PA/EZ-DR/KS/ 300/YUC	2314309	1
	4 m	FLK 50-PA/EZ-DR/KS/ 400/YUC	2314312	1
	5 m	FLK 50-PA/EZ-DR/KS/ 500/YUC	2321499	1
	6 m	FLK 50-PA/EZ-DR/KS/ 600/YUC	2314927	1
	7 m	FLK 50-PA/EZ-DR/KS/ 700/YUC	2321509	1
	8 m	FLK 50-PA/EZ-DR/KS/ 800/YUC	2314930	1
	9 m	FLK 50-PA/EZ-DR/KS/ 900/YUC	2321512	1
	10 m	FLK 50-PA/EZ-DR/KS/1000/YUC	2314325	1
	15 m	FLK 50-PA/EZ-DR/KS/1500/YUC	2314338	1
	20 m	FLK 50-PA/EZ-DR/KS/2000/YUC	2314503	1
	25 m	FLK 50-PA/EZ-DR/KS/2500/YUC	2314516	1
	30 m	FLK 50-PA/EZ-DR/KS/3000/YUC	2314529	1
Front adapter, for analog I/O modules, 40-pos.				
	1 m	FLK 40-PA/EZ-DR/KS/ 100/YUC	2322786	1
	2 m	FLK 40-PA/EZ-DR/KS/ 200/YUC	2314341	1
	3 m	FLK 40-PA/EZ-DR/KS/ 300/YUC	2314354	1
	4 m	FLK 40-PA/EZ-DR/KS/ 400/YUC	2314367	1
	5 m	FLK 40-PA/EZ-DR/KS/ 500/YUC	2321570	1
	6 m	FLK 40-PA/EZ-DR/KS/ 600/YUC	2314943	1
	7 m	FLK 40-PA/EZ-DR/KS/ 700/YUC	2321583	1
	8 m	FLK 40-PA/EZ-DR/KS/ 800/YUC	2314956	1
	9 m	FLK 40-PA/EZ-DR/KS/ 900/YUC	2321415	1
	10 m	FLK 40-PA/EZ-DR/KS/1000/YUC	2314370	1
	15 m	FLK 40-PA/EZ-DR/KS/1500/YUC	2314383	1
	20 m	FLK 40-PA/EZ-DR/KS/2000/YUC	2314532	1
	25 m	FLK 40-PA/EZ-DR/KS/2500/YUC	2314545	1
	30 m	FLK 40-PA/EZ-DR/KS/3000/YUC	2314558	1

Ordering data

Description	Cable length	Type	Order No.	Pcs./Pkt.
Front adapter, for digital I/O modules, 50-pos.				
	1 m	FLK 50-PA/EZ-DR/HF/KS/ 100/YUC	2904739	1
	2 m	FLK 50-PA/EZ-DR/HF/KS/ 200/YUC	2904740	1
	3 m	FLK 50-PA/EZ-DR/HF/KS/ 300/YUC	2904741	1
	4 m	FLK 50-PA/EZ-DR/HF/KS/ 400/YUC	2904742	1
	5 m	FLK 50-PA/EZ-DR/HF/KS/ 500/YUC	2904636	1
	6 m	FLK 50-PA/EZ-DR/HF/KS/ 600/YUC	2904743	1
	7 m	FLK 50-PA/EZ-DR/HF/KS/ 700/YUC	2904744	1
	8 m	FLK 50-PA/EZ-DR/HF/KS/ 800/YUC	2904745	1
	9 m	FLK 50-PA/EZ-DR/HF/KS/ 900/YUC	2904746	1
	10 m	FLK 50-PA/EZ-DR/HF/KS/1000/YUC	2904637	1
	15 m	FLK 50-PA/EZ-DR/HF/KS/1500/YUC	2904638	1
	20 m	FLK 50-PA/EZ-DR/HF/KS/2000/YUC	2904487	1
	25 m	FLK 50-PA/EZ-DR/HF/KS/2500/YUC	2904639	1
	30 m	FLK 50-PA/EZ-DR/HF/KS/3000/YUC	2904640	1
Front adapter, for analog I/O modules, 40-pos.				
	1 m	FLK 40-PA/EZ-DR/HF/KS/ 100/YUC	2904747	1
	2 m	FLK 40-PA/EZ-DR/HF/KS/ 200/YUC	2904748	1
	3 m	FLK 40-PA/EZ-DR/HF/KS/ 300/YUC	2904749	1
	4 m	FLK 40-PA/EZ-DR/HF/KS/ 400/YUC	2904750	1
	5 m	FLK 40-PA/EZ-DR/HF/KS/ 500/YUC	2904645	1
	6 m	FLK 40-PA/EZ-DR/HF/KS/ 600/YUC	2904751	1
	7 m	FLK 40-PA/EZ-DR/HF/KS/ 700/YUC	2904752	1
	8 m	FLK 40-PA/EZ-DR/HF/KS/ 800/YUC	2904753	1
	9 m	FLK 40-PA/EZ-DR/HF/KS/ 900/YUC	2904754	1
	10 m	FLK 40-PA/EZ-DR/HF/KS/1000/YUC	2904646	1
	15 m	FLK 40-PA/EZ-DR/HF/KS/1500/YUC	2904647	1
	20 m	FLK 40-PA/EZ-DR/HF/KS/2000/YUC	2904488	1
	25 m	FLK 40-PA/EZ-DR/HF/KS/2500/YUC	2904648	1
	30 m	FLK 40-PA/EZ-DR/HF/KS/3000/YUC	2904649	1

Yokogawa CENTUM VP**Front adapters**

These front adapters for digital I/O modules are connected directly to the modules.

Features:

- Lateral cable outlet of the I/O module
- Four 14-pos. connectors on the module side for connection of four 8-channel VARIOFACE modules of the system cabling

**Shielded****Technical data**

Maximum permissible operating voltage	30 V DC
Maximum permissible operating voltage UL / CSA	125 V / -
Maximum permissible current	500 mA (per path at 70°C)
Maximum conductor resistance	0.16 Ω/m
Conductor cross section	AWG 26 / 0.14 mm ²
Outside diameter	11 mm
Ambient temperature range	-20°C ... 50°C

Ordering data

Description	Cable length	Type	Order No.	Pcs./Pkt.
Front adapter for digital I/O modules for coupling four 8-channel VARIOFACE modules, 50-pos.				
	2 m	CABLE-50/4FLK14/ 2,0M/YUC	2314655	1
	4 m	CABLE-50/4FLK14/ 4,0M/YUC	2314671	1
	6 m	CABLE-50/4FLK14/ 6,0M/YUC	2318978	1
	10 m	CABLE-50/4FLK14/10,0M/YUC	2314684	1
	15 m	CABLE-50/4FLK14/15,0M/YUC	2322773	1
	20 m	CABLE-50/4FLK14/20,0M/YUC	2314778	1

Yokogawa CENTUM VP**Front adapters for MINI Analog system cabling**

This front adapter enables 16 MINI Analog modules to be connected to a Yokogawa controller. Together with two MINI MCR-2-V8-FLK 16 MINI Analog system adapters, the Yokogawa system cable is a simple, cost-effective “Plug and Play” solution.

The front adapter is connected directly to the Yokogawa module. Two 16-pos. IDC/FLK socket strips are attached for connecting the module to the MINI Analog system adapters.

Together with **4-conductor measuring transducers**, the front adapter is suitable for the following analog cards:

- AAI 141
- AAI 143

**Shielded****Technical data**

Maximum permissible operating voltage	30 V DC
Maximum permissible operating voltage UL / CSA	125 V / -
Maximum permissible current	500 mA (per path at 70°C)
Maximum conductor resistance	0.16 Ω/m
Conductor cross section	AWG 26 / 0.14 mm ²
Outside diameter	11 mm
Ambient temperature range	-20°C ... 50°C

Ordering data

Description	Cable length	Type	Order No.	Pcs./Pkt.
Front adapter , for analog I/O modules for coupling two 8-channel MINI analog system adapters, 40-pos.				
	2 m	CABLE-40/2FLK16/ 2,0M/YUC	2321334	1
	4 m	CABLE-40/2FLK16/ 4,0M/YUC	2321347	1
	10 m	CABLE-40/2FLK16/10,0M/YUC	2321350	1
	15 m	CABLE-40/2FLK16/15,0M/YUC	2321376	1
	20 m	CABLE-40/2FLK16/20,0M/YUC	2321363	1

System cabling for controllers

Controller-specific system cabling

VIP termination boards for 8 channels

These VIP – VARIOFACE Professional modules are used in combination with 14-pos. system cables and the relevant front adapters.

Features:

- Byte-wise labeling
- For digital I/O modules
- Optionally with LED

Notes:
For marking systems (e.g., "ZB 22:UNBEDRUCKT"; Order No. 0811862) and mounting material, see Catalog 3.



Passive interface module for input/output with screw connection



Passive interface module for input/output with Push-in connection



Technical data	
Maximum permissible operating voltage	25 V AC / 60 V DC
Maximum permissible operating voltage UL / CSA	125 V / 125 V
Maximum permissible current (per branch)	1 A
Maximum total current (voltage supply)	3 A
Ambient temperature (operation)	-20°C ... 50°C
Mounting position	Any
Standards/regulations	IEC 60664, DIN EN 50178
Connection method	Screw connection
	Field level
	Controller level
Connection data solid/stranded/AWG	0.2 ... 4 mm ² / 0.2 ... 2.5 mm ² / 24 - 12
Dimensions	H / D

Technical data	
VIP-2/.../FLK14/PLC	VIP-2/.../FLK14/LED/PLC
25 V AC / 60 V DC	24 V DC
125 V / 125 V	24 V / 24 V
1 A	1 A
3 A	3 A
-20°C ... 50°C	-20°C ... 50°C
Any	Any
IEC 60664, DIN EN 50178	Screw connection
Screw connection	Screw connection
Field level	Field level
Controller level	Controller level
IDC/FLK pin strip	IDC/FLK pin strip
IDC/FLK pin strip	IDC/FLK pin strip
0.2 ... 4 mm ² / 0.2 ... 2.5 mm ² / 24 - 12	0.14 ... 2.5 mm ² / 0.14 ... 2.5 mm ² / 26 - 14
65.5 mm / 56 mm	72.1 mm / 56 mm

Technical data	
VIP-2/.../FLK14/PLC	VIP-2/.../FLK14/LED/PLC
25 V AC / 60 V DC	24 V DC
- / -	24 V / 24 V
1 A	1 A
3 A	3 A
-20°C ... 50°C	-20°C ... 50°C
Any	Any
IEC 60664, DIN EN 50178	Push-in connection
Push-in connection	Push-in connection
Field level	Field level
Controller level	Controller level
IDC/FLK pin strip	IDC/FLK pin strip
IDC/FLK pin strip	IDC/FLK pin strip
0.14 ... 2.5 mm ² / 0.14 ... 2.5 mm ² / 26 - 14	0.14 ... 2.5 mm ² / 0.14 ... 2.5 mm ² / 26 - 14
72.1 mm / 56 mm	72.1 mm / 56 mm

Ordering data		
Description	No. of pos.	Module width W
VARIOFACE interface module , for eight channels,		
- with screw connection	14	39.8 mm
- with Push-in connection	14	41.9 mm
VARIOFACE interface module , for eight channels with light indicator,		
- with screw connection	14	39.8 mm
- with Push-in connection	14	41.9 mm

Ordering data		
Type	Order No.	Pcs./Pkt.
VIP-2/SC/FLK14/PLC	2315214	1
VIP-2/SC/FLK14/LED/PLC	2322249	1

Ordering data		
Type	Order No.	Pcs./Pkt.
VIP-2/PT/FLK14/PLC	2903801	1
VIP-2/PT/FLK14/LED/PLC	2904279	1

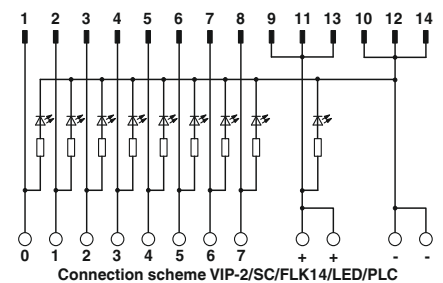
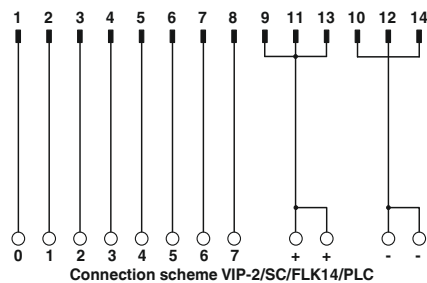

VIP termination boards for 32 channels

These VIP – VARIOFACE Professional modules are used in combination with 50-pos. system cables and the relevant front adapters.

Features:

- Byte-wise labeling
- For digital I/O modules
- Optionally with LED

Notes:
For marking systems (e.g., "ZB 22:UNBEDRUCKT"; Order No. 0811862) and mounting material, see Catalog 3.

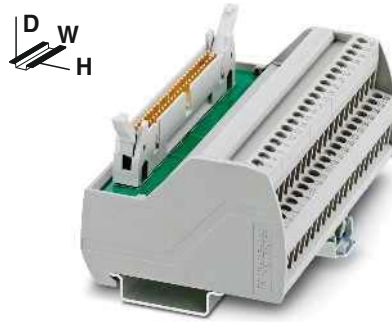

Passive interface module for input/output with screw connection

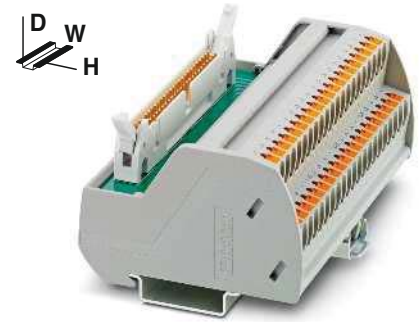

Passive interface module for input/output with Push-in connection



Technical data	
Maximum permissible operating voltage	25 V AC / 60 V DC
Maximum permissible operating voltage UL / CSA	125 V / 125 V
Maximum permissible current (per branch)	1 A
Maximum total current (voltage supply)	2 A (per byte)
Ambient temperature (operation)	-20°C ... 50°C
Mounting position	Any
Standards/regulations	IEC 60664, DIN EN 50178
Connection method	Screw connection
	Field level
	Controller level
Connection data solid/stranded/AWG	0.2 ... 4 mm ² / 0.2 ... 2.5 mm ² / 24 - 12
Dimensions	H / D

Technical data	
VIP-2/.../FLK50/PLC	VIP-2/.../FLK50/LED/PLC
25 V AC / 60 V DC	24 V DC
125 V / 125 V	24 V / 24 V
1 A	1 A
2 A (per byte)	2 A (per byte)
-20°C ... 50°C	-20°C ... 50°C
Any	Any
IEC 60664, DIN EN 50178	Screw connection
	Field level
	Controller level
0.2 ... 4 mm ² / 0.2 ... 2.5 mm ² / 24 - 12	IDC/FLK pin strip
65.5 mm / 56 mm	IDC/FLK pin strip

Technical data	
VIP-2/.../FLK50/PLC	VIP-2/.../FLK50/LED/PLC
25 V AC / 60 V DC	24 V DC
125 V / 125 V	24 V / 24 V
1 A	1 A
2 A (per byte)	2 A (per byte)
-20°C ... 50°C	-20°C ... 50°C
Any	Any
IEC 60664, DIN EN 50178	Push-in connection
	Field level
	Controller level
0.14 ... 2.5 mm ² / 0.14 ... 2.5 mm ² / 26 - 14	IDC/FLK pin strip
72.1 mm / 56 mm	IDC/FLK pin strip

Description	No. of pos.	Module width W
VARIOFACE interface module , for 32 channels,		
- with screw connection	50	106.1 mm
- with Push-in connection	50	107.9 mm
VARIOFACE interface module , for 32 channels with light indicator,		
- with screw connection	50	106.1 mm
- with Push-in connection	50	107.9 mm

Ordering data		
Type	Order No.	Pcs./Pkt.
VIP-2/SC/FLK50/PLC	2315227	1
VIP-2/SC/FLK50/LED/PLC	2322252	1

Ordering data		
Type	Order No.	Pcs./Pkt.
VIP-2/PT/FLK50/PLC	2903803	1
VIP-2/PT/FLK50/LED/PLC	2904280	1

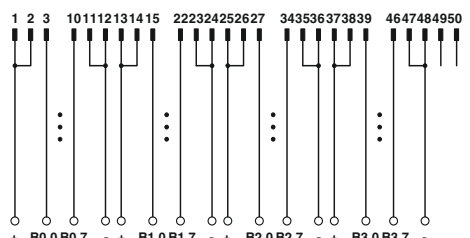

Connection scheme VIP-2/SC/FLK50/PLC

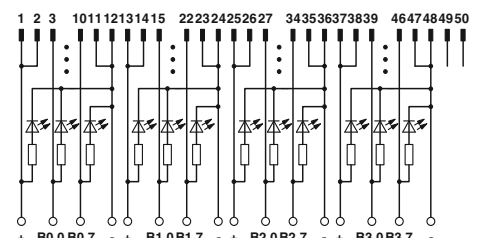

Connection scheme VIP-2/SC/FLK50/LED/PLC

System cabling for controllers

Controller-specific system cabling

VIP termination boards in 2-conductor connection technology for 8 channels

These VIP – VARIOFACE Professional modules are used in combination with 14-pos. system cables and the relevant front adapters.

Features:

- Byte-wise labeling
- For digital I/O modules
- Negative or positive connection per signal

Notes:
For marking systems (e.g., "ZB 22:UNBEDRUCKT"; Order No. 0811862) and mounting material, see Catalog 3.

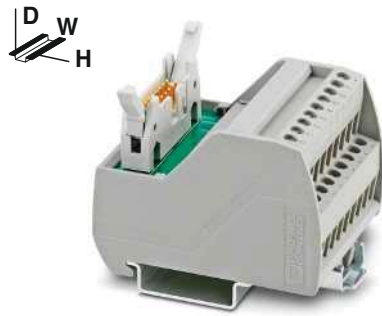

Passive interface module with screw connection

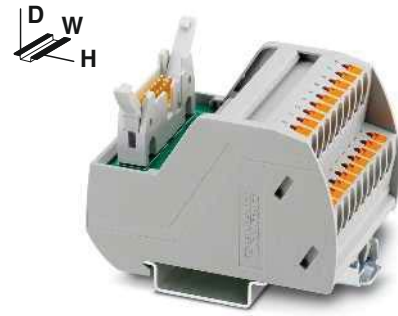

Passive interface module with Push-in connection



Technical data

Maximum permissible operating voltage	25 V AC / 60 V DC
Maximum permissible operating voltage UL / CSA	125 V / -
Maximum permissible current (per branch)	1 A
Maximum total current (voltage supply)	3 A (per byte)
Ambient temperature (operation)	-20°C ... 50°C
Mounting position	Any
Standards/regulations	IEC 60664, DIN EN 50178
Connection method	Field level Screw connection Controller level IDC/FLK pin strip
Connection data solid/stranded/AWG	0.2 ... 4 mm ² / 0.2 ... 2.5 mm ² / 24 - 12
Dimensions	H / D 65.5 mm / 56 mm

Technical data

Maximum permissible operating voltage	25 V AC / 60 V DC
Maximum permissible operating voltage UL / CSA	125 V / 125 V
Maximum permissible current (per branch)	1 A
Maximum total current (voltage supply)	3 A (per byte)
Ambient temperature (operation)	-20°C ... 50°C
Mounting position	Any
Standards/regulations	IEC 60664, DIN EN 50178
Connection method	Field level Push-in connection Controller level IDC/FLK pin strip
Connection data solid/stranded/AWG	0.14 ... 2.5 mm ² / 0.14 ... 2.5 mm ² / 26 - 14
Dimensions	72.1 mm / 56 mm

Ordering data

Description	No. of pos.	Module width W	Type	Order No.	Pcs./Pkt.
VARIOFACE interface module , for eight channels, each with an additional terminal block per signal for a common minus potential					
- with screw connection	14	50 mm	VIP-2/SC/FLK14/8M/PLC	2322281	1
- with Push-in connection	14	52 mm			
VARIOFACE interface module , for eight channels, each with an additional terminal block per signal for a common plus potential					
- with screw connection	14	50 mm	VIP-2/SC/FLK14/8P/PLC	2322294	1
- with Push-in connection	14	52 mm			

Ordering data

Description	No. of pos.	Module width W	Type	Order No.	Pcs./Pkt.
VARIOFACE interface module , for eight channels, each with an additional terminal block per signal for a common minus potential					
- with Push-in connection	14	52 mm	VIP-2/PT/FLK14/8M/PLC	2904283	1
VARIOFACE interface module , for eight channels, each with an additional terminal block per signal for a common plus potential					
- with Push-in connection	14	52 mm	VIP-2/PT/FLK14/8P/PLC	2904284	1

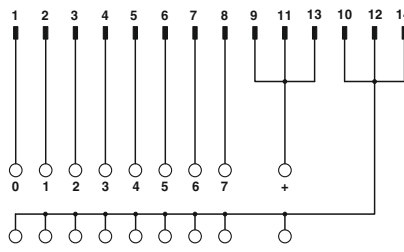

Connection scheme VIP-2/.../FLK14/8M/PLC

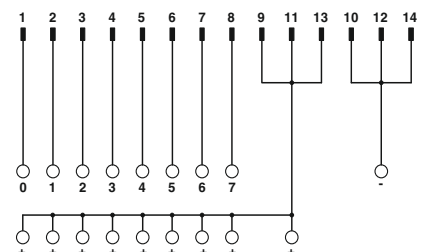

Connection scheme VIP-2/.../FLK14/8P/PLC

Termination boards in 2-conductor connection technology for 32 channels

These VARIOFACE modules are used in combination with 50-pos. system cables and the relevant front adapters.

The following module types with 2-conductor connection technology are available:

FLKM 50/32M/PLC

- Byte-wise labeling
- For digital I/O modules
- Negative connection for each signal

FLKM 50/32P/PLC

- Byte-wise labeling
- For digital I/O modules
- Positive connection per signal

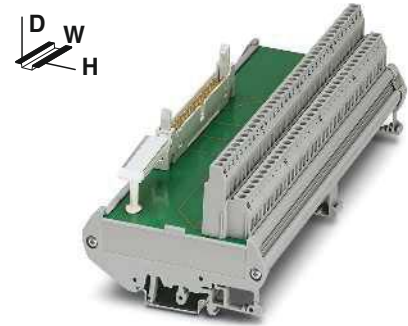

Passive interface module with screw connection



Technical data

Maximum permissible operating voltage	60 V DC
Maximum permissible operating voltage UL / CSA	125 V / -
Maximum permissible current (per branch)	1 A
Maximum total current (voltage supply)	8 A (per byte)
Ambient temperature (operation)	-20°C ... 50°C
Mounting position	Any
Standards/regulations	DIN EN 50178, IEC 60664
Connection method	Field level Controller level Screw connection
Connection data solid/stranded/AWG	IDC/FLK pin strip 0.2 ... 4 mm ² / 0.2 ... 2.5 mm ² / 24 - 12
Dimensions	H / D 90 mm / 68 mm

Ordering data

Description	No. of pos.	Module width W	Type	Order No.	Pcs./Pkt.
VARIOFACE interface module , for 32 channels, each with an additional terminal block per signal for a common minus potential	50	192 mm	FLKM 50/32M/PLC	2289719	1
VARIOFACE interface module , for 32 channels, each with an additional terminal block per signal for a common plus potential	50	192 mm	FLKM 50/32P/PLC	2291121	1

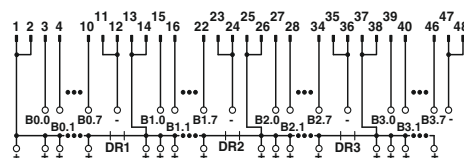

Connection scheme FLKM 50/32P/PLC

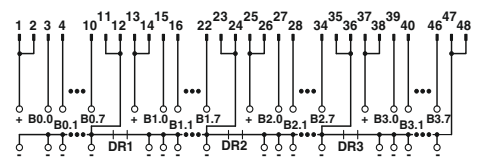

Connection scheme FLKM 50/32M/PLC

System cabling for controllers

Controller-specific system cabling

Termination boards with fuses in 2-conductor connection method

These VARIOFACE modules are used in combination with 14 or 50-pos. system cables and the relevant front adapters.

- Byte-wise labeling
- Can be used for digital I/O modules
- TR5® plug-in fuse (IEC 60127-3, 1AF) per signal path (F1)
- TR5® plug-in fuse (IEC 60127-3, 2AF) per voltage supply (F2)
- Negative connection for each signal

FLKM 14/8M/SI/PLC (for 8 channels) FLKM 50/32M/SI/PLC (for 32 channels)

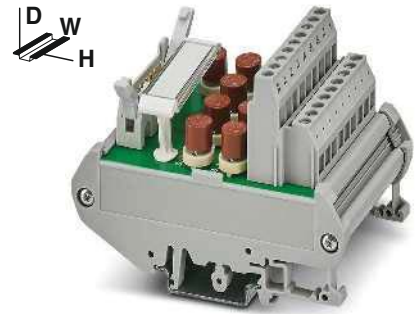

Passive fuse module for 8 or 32 channels



Technical data

	FLKM 14/8M/SI/PLC	FLKM 50/32M/SI/PLC
Maximum permissible operating voltage	60 V DC	60 V DC
Maximum permissible operating voltage UL / CSA	125 V / -	125 V / -
Maximum permissible current (per branch)	1 A	1 A
Maximum total current (voltage supply)	2 A	2 A (per byte)
Ambient temperature (operation)	-20°C ... 50°C	-20°C ... 50°C
Mounting position	Any	Any
Standards/regulations	DIN EN 50178, IEC 60664	
Connection method	Screw connection	Screw connection
	Field level	Field level
	Controller level	Controller level
Connection data solid/stranded/AWG	0.2 ... 4 mm ² / 0.2 ... 2.5 mm ² / 24 - 12	
Dimensions	90 mm / 68 mm	

Ordering data

Description	No. of pos.	Module width W	Type	Order No.	Pcs./Pkt.
VARIOFACE module , for eight channels, each with an additional terminal block and fuse per signal, (common minus potential)	14	57 mm	FLKM 14/8M/SI/PLC	2294487	1
VARIOFACE module , for 32 channels, each with an additional terminal block and fuse per signal, (common minus potential)	50	192 mm	FLKM 50/32M/SI/PLC	2294490	1

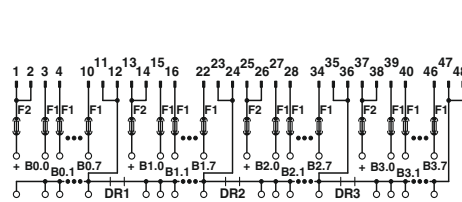

Connection scheme: FLKM 50/32M/SI/PLC

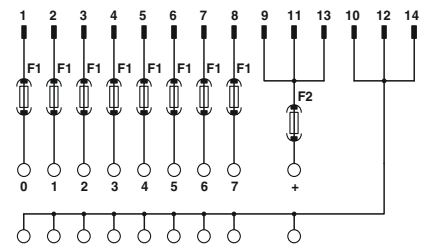

Connection scheme: FLKM 14/8M/SI/PLC

VIP initiator modules for 8 channels

These VIP – VARIOFACE Professional modules are used in combination with 14-pos. system cables and the relevant front adapters.

Features:

- Byte-wise labeling
- For digital I/O modules
- Positive and negative connection per signal
- Optionally with LED

Notes:
For marking systems (e.g., "ZB 22:UNBEDRUCKT"; Order No. 0811862) and mounting material, see Catalog 3.

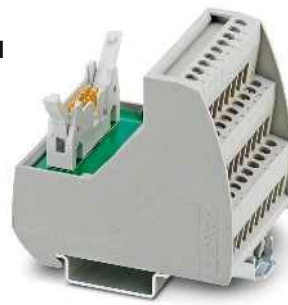

Initiator module for 8 channels with screw connection



Initiator module for 8 channels with Push-in connection



Maximum permissible operating voltage	25 V AC / 60 V DC
Maximum permissible operating voltage UL / CSA	125 V / -
Maximum permissible current (per branch)	1 A
Maximum total current (voltage supply)	3 A
Ambient temperature (operation)	-20°C ... 50°C
Mounting position	Any
Standards/regulations	IEC 60664, DIN EN 50178
Connection method	Screw connection
	Field level
	Controller level
Connection data solid/stranded/AWG	0.2 ... 4 mm ² / 0.2 ... 2.5 mm ² / 24 - 12
Dimensions	69 mm / 62 mm

Technical data	
VIP-3/SC/FLK14/8IM/PLC	VIP-3/SC/FLK14/8IM/LED/PLC
25 V AC / 60 V DC	24 V DC
125 V / -	24 V / 24 V
1 A	1 A
3 A	3 A
-20°C ... 50°C	-20°C ... 50°C
Any	Any
IEC 60664, DIN EN 50178	IEC 60664, DIN EN 50178
Screw connection	Screw connection
IDC/FLK pin strip	IDC/FLK pin strip
0.2 ... 4 mm ² / 0.2 ... 2.5 mm ² / 24 - 12	0.2 ... 4 mm ² / 0.2 ... 2.5 mm ² / 24 - 12
69 mm / 62 mm	69 mm / 62 mm

Ordering data		
Type	Order No.	Pcs./Pkt.
VIP-3/SC/FLK14/8IM/PLC	2322278	1
VIP-3/SC/FLK14/8IM/LED/PLC	2322265	1

Description	No. of pos.	Module width W
VARIOFACE initiator module , for connecting 8 PNP initiators, with an additional positive and negative terminal block each per signal		
- with screw connection	14	52.3 mm
- with Push-in connection	14	52 mm
VARIOFACE initiator module with LED , for connecting 8 PNP initiators, with an additional positive and negative terminal block each per signal		
- with screw connection	14	52.3 mm
- with Push-in connection	14	52 mm

Technical data	
VIP-3/PT/FLK14/8IM/PLC	VIP-3/PT/FLK14/8IM/LED/PLC
25 V AC / 60 V DC	24 V DC
125 V / 125 V	24 V / 24 V
1 A	1 A
3 A	3 A
-20°C ... 50°C	-20°C ... 50°C
Any	Any
IEC 60664, DIN EN 50178	IEC 60664, DIN EN 50178
Push-in connection	Push-in connection
IDC/FLK pin strip	IDC/FLK pin strip
0.14 ... 2.5 mm ² / 0.14 ... 2.5 mm ² / 26 - 14	0.14 ... 2.5 mm ² / 0.14 ... 2.5 mm ² / 26 - 14
75.8 mm / 63 mm	75.8 mm / 63 mm

Ordering data		
Type	Order No.	Pcs./Pkt.
VIP-3/PT/FLK14/8IM/PLC	2904282	1
VIP-3/PT/FLK14/8IM/LED/PLC	2904281	1

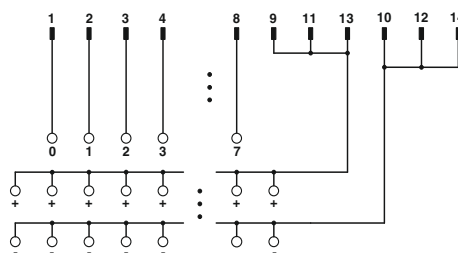

Connection scheme VIP-3/.../FLK14/8IM/PLC

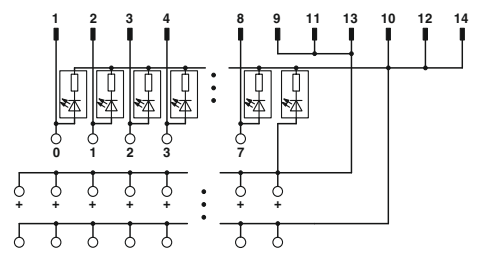

Connection scheme VIP-3/.../FLK14/8IM/LED/PLC

System cabling for controllers

Controller-specific system cabling

Initiator modules for 32 channels

These VARIOFACE modules are used in combination with 50-pos. system cables and the relevant front adapters for digital I/O modules.

Features:

- Byte-wise labeling
- Positive and negative connection per signal
- Optionally with LED
- Can be used for digital I/O modules

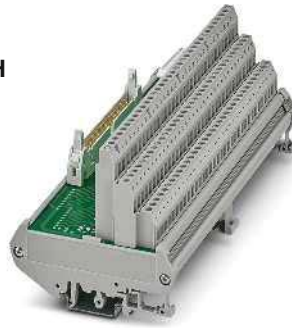

Initiator module for 32 channels, with screw connection

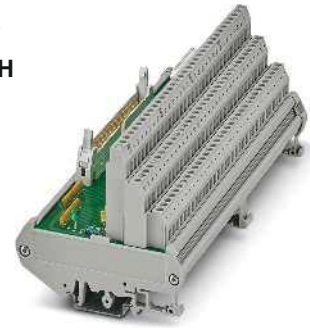

Initiator module for 32 channels, with screw connection and LED display



Technical data

Maximum permissible operating voltage
Maximum permissible operating voltage UL / CSA

60 V DC
125 V / -

Maximum permissible current (per branch)
Maximum total current (voltage supply)

1 A
2 A (per byte)

Status indication
Ambient temperature (operation)
Mounting position
Standards/regulations
Connection method

-
-20°C ... 50°C
Any
DIN EN 50178, IEC 60664
Screw connection

Connection data solid/stranded/AWG
Dimensions

Field level
Controller level
IDC/FLK pin strip
0.2 ... 4 mm² / 0.2 ... 2.5 mm² / 24 - 12
90 mm / 81 mm

Technical data

30 V DC
24 V / -

1 A
2 A (per byte)

LED
-20°C ... 50°C
Any
DIN EN 50178, IEC 60664
Screw connection

IDC/FLK pin strip
0.2 ... 4 mm² / 0.2 ... 2.5 mm² / 24 - 12
90 mm / 81 mm

Ordering data

Description	No. of pos.	Module width W
VARIOFACE initiator module , for connection of 32 PNP initiators	50	180 mm
VARIOFACE initiator module , same as before, however with light indicator	50	180 mm

Type	Order No.	Pcs./Pkt.
FLKMS 50/32IM/PLC	2284523	1

Ordering data

Type	Order No.	Pcs./Pkt.
FLKMS 50/32IM/LA/PLC	2284510	1

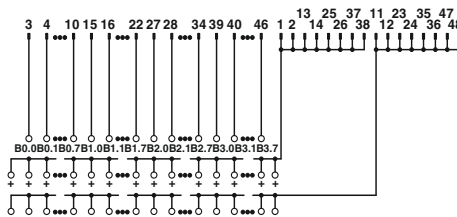

Connection scheme FLKMS 50/32IM/PLC

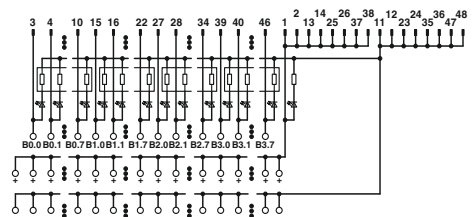

Connection scheme FLKMS 50/32IM/LA/PLC

Controller boards with knife disconnect terminal blocks

These VARIOFACE modules with knife disconnection and test connection for each signal (2 or 2.3 mm Ø test plug) are used in combination with the respective front adapters.

FLKM14/KDS3-MT/PPA/PLC (for 8 channels)

FLKM 50/KDS3-MT/PPA/PLC (for 32 channels)

- Byte-wise labeling
- Can be used for digital I/O modules

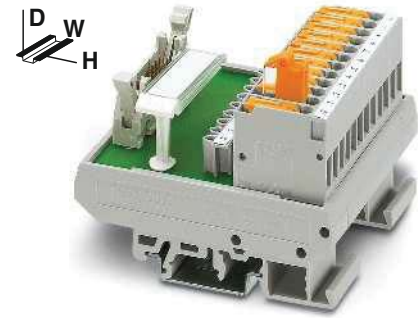

Passive termination board for 8 or 32 channels with knife disconnect terminal blocks



Maximum permissible operating voltage
Maximum permissible operating voltage UL / CSA

Maximum permissible current (per branch)
Maximum total current (voltage supply)

Ambient temperature (operation)
Mounting position
Standards/regulations
Connection method

Connection data solid/stranded/AWG
Dimensions

Field level

Controller level

H / D

Technical data

FLKM...14/KDS3-MT...	FLKM 50/KDS3-MT...
60 V DC	60 V DC
24 V / -	24 V / -
1 A	1 A
3 A	2 A (per byte)
-20°C ... 50°C	-20°C ... 50°C
Any	Any
DIN EN 50178, IEC 60664	
Screw connection with disconnect knife	Screw connection with disconnect knife
IDC/FLK pin strip	IDC/FLK pin strip
0.2 ... 4 mm ² / 0.2 ... 2.5 mm ² / 24 - 12	
77 mm / 61 mm	

Ordering data

Description	No. of pos.	Module width W	Type	Order No.	Pcs./Pkt.
VARIOFACE interface module , for eight channels, with knife disconnect terminal blocks and test sockets to the field and the system	14	67 mm	FLKM 14/KDS3-MT/PPA/PLC	2290423	1
VARIOFACE interface module , for 32 channels, with knife disconnect terminal blocks and test sockets to the field and the system	50	214 mm	FLKM 50/KDS3-MT/PPA/PLC	2290614	1

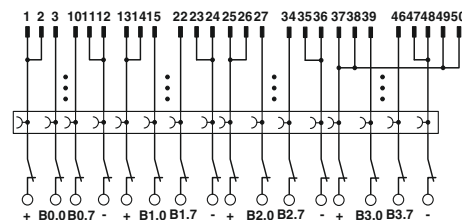

Connection scheme FLKM 50/KDS3-MT/PPA/PLC

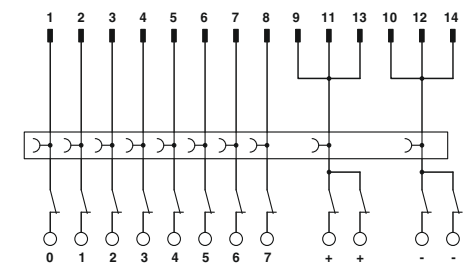

Connection scheme FLKM 14/KDS3-MT/PPA/PLC

Controller-specific system cabling

Output modules with relays, one N/O contact

These VARIOFACE output modules are used in combination with the respective front adapters.

- Plug-in miniature relays, each with an N/O contact
- Universal applications from 1 mA to 3 A continuous current through 2-layer double contact with hard gold plating
- Slim construction widths of only 55 mm (8 channels) or 202 mm (32 channels)
- LED status display for each signal path and supply voltage
- Free-wheeling and reverse polarity protection diode for each signal path

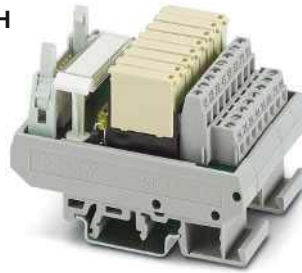

Output module with eight miniature relays, 1 N/O contacts

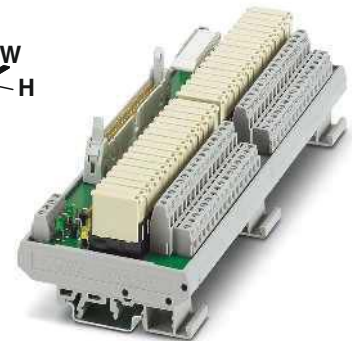

Output module with 32 miniature relays, 1 N/O contact

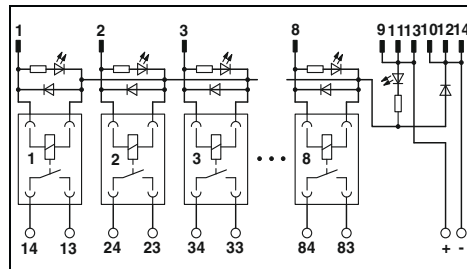

Technical data

Coil side	
Operating voltage U_N	24 V DC
Typical input current at U_N	6.5 mA
Typical response time at U_N	5 ms
Typical release time at U_N	15 ms
Input circuit	Free-wheeling diode, reverse polarity protection
Status indicator per channel	Yellow LED
Connection method	IDC/FLK pin strip
No. of pos.	14
Contact side	
Contact type	1 N/O contact
Contact material	AgNi, 5 μ m hard gold-plated
Max. switching voltage	250 V AC / 125 V DC
Minimum switching voltage	5 V
Maximum switch-on current	5 A
Limiting continuous current	3 A
Minimum switching current	1 mA
Maximum interrupting rating:	24 V DC 72 W 48 V DC 60 W 60 V DC 50 W 110 V DC 50 W 250 V AC 750 VA
Connection method	Screw connection
Connection data solid/stranded/AWG	0.14 ... 1.5 mm ² / 0.14 ... 1.5 mm ² / 26 - 14
General data	
Rated insulation voltage	260 V AC
Rated surge voltage	4 kV (basic insulation)
Degree of pollution/overvoltage category	2 / III
Ambient temperature (operation)	-20°C ... 50°C
Nominal operating mode	100% operating factor
Mechanical service life	2x 10 ⁷ cycles
Standards/regulations	DIN EN 50178, IEC 60664
Mounting position	Any
Mounting	In rows with zero spacing
Dimensions	90 mm / 58 mm
EMC note	Class A product, see page 583

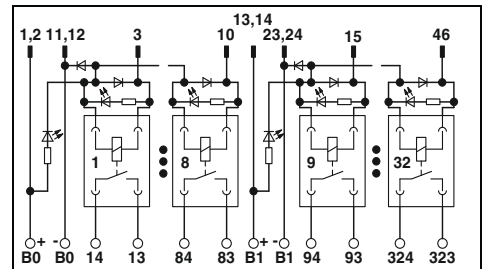

Technical data

Coil side	
Operating voltage U_N	24 V DC
Typical input current at U_N	6.5 mA
Typical response time at U_N	5 ms
Typical release time at U_N	15 ms
Input circuit	Free-wheeling diode, reverse polarity protection
Status indicator per channel	Yellow LED
Connection method	IDC/FLK pin strip
No. of pos.	50
Contact side	
Contact type	1 N/O contact
Contact material	AgNi, 5 μ m hard gold-plated
Max. switching voltage	250 V AC / 125 V DC
Minimum switching voltage	5 V
Maximum switch-on current	5 A
Limiting continuous current	3 A
Minimum switching current	1 mA
Maximum interrupting rating:	24 V DC 72 W 48 V DC 60 W 60 V DC 50 W 110 V DC 50 W 250 V AC 750 VA
Connection method	Screw connection
Connection data solid/stranded/AWG	0.14 ... 1.5 mm ² / 0.14 ... 1.5 mm ² / 26 - 16
General data	
Rated insulation voltage	260 V AC
Rated surge voltage	4 kV (basic insulation)
Degree of pollution/overvoltage category	2 / III
Ambient temperature (operation)	-20°C ... 50°C
Nominal operating mode	100% operating factor
Mechanical service life	2x 10 ⁷ cycles
Standards/regulations	DIN EN 50178, IEC 60664
Mounting position	Any
Mounting	In rows with zero spacing
Dimensions	90 mm / 58 mm
EMC note	Class A product, see page 583

Ordering data

Description	Module width W	Type	Order No.	Pcs./Pkt.
VARIOFACE output module, with eight miniature relays, plugged, for 24 V DC (incl. relays)	56	UMK- 8 RM/MR-G24/ 1/PLC	2979469	1
VARIOFACE output module, with eight miniature relays, plugged, for 24 V DC (incl. relays)	202			

Ordering data

Description	Module width W	Type	Order No.	Pcs./Pkt.
VARIOFACE output module, with 32 miniature relays, plugged, for 24 V DC (incl. relays)	202	UMK-32 RM/MR-G24/1/PLC	2979472	1

Accessories

Pluggable miniature relays	Accessories	Order No.	Pcs./Pkt.
REL-MR-G 24/1	REL-MR-G 24/1	2961037	8

Pluggable miniature relays	Accessories	Order No.	Pcs./Pkt.
REL-MR-G 24/1	REL-MR-G 24/1	2961037	8

VIP output modules with relay, 1 changeover contact with fuse

These VIP – VARIOFACE Professional output modules are used in combination with the respective front adapters. Like the front adapters, the modules are connected via 14-pole system cables.

Features:

- Plug-in miniature relays, each with a PDT contact
- LED status display for each signal path and supply voltage
- TE5® plug-in fuse (IEC 60127-3, 6,3AT) per signal path (F0...F7)
- Free-wheeling diode for each signal path
- Push-in connection



Output module with 8 miniature relays, 1 PDT and fuse per output circuit

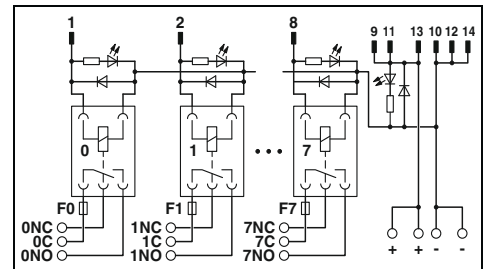

Technical data

Coil side		
Operating voltage U_N		24 V DC
Typical input current at U_N		9 mA
Typical response time at U_N		5 ms
Typical release time at U_N		8 ms
Input circuit		Free-wheeling diode
Status indicator per channel		Yellow LED
Connection method		IDC/FLK pin strip
No. of pos.		14
Contact side		
Contact type		Single contact, 1-PDT
Contact material		AgSnO
Max. switching voltage		250 V AC/DC
Minimum switching voltage		12 V AC/DC
Limiting continuous current		5 A (observe derating)
Minimum switching current		10 mA
Maximum interrupting rating:		24 V DC 120 W
		48 V DC 20 W
		60 V DC 18 W
		110 V DC 23 W
		220 V DC 40 W
		250 V AC 1250 VA
Connection method		Push-in connection
Connection data solid/stranded/AWG		0.14 ... 2.5 mm ² / 0.14 ... 2.5 mm ² / 26 - 14
General data		
Ambient temperature (operation)		-20°C ... 60°C
Nominal operating mode		100% operating factor
Mechanical service life		2x 10 ⁷ cycles
Standards/regulations		DIN EN 50178
Mounting position		Any
Mounting		In rows with zero spacing
Dimensions	H / D	109.8 mm / 63 mm
EMC note		Class A product, see page 583

Ordering data

Description	Module width W	Type	Order No.	Pcs./Pkt.
VARIOFACE output module, with eight miniature relays, plugged, for 24 V DC (incl. relays)	87.6	VIP-8RPT-24DC/21/DO/FU/PLC	2903601	1

VIP input modules

These VIP – VARIOFACE Professional input modules are used in combination with the respective front adapters. Like the front adapters, the modules are connected via 14-pole system cables.

- Features:
- Plug-in miniature relays, each with an N/O contact
 - LED status display for each signal path and supply voltage
 - Free-wheeling diode for each signal path
 - Push-in connection

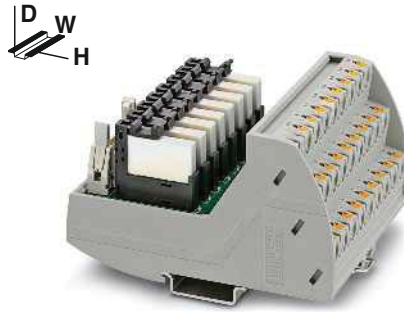

Digital input module with 8 channels for 24 V DC

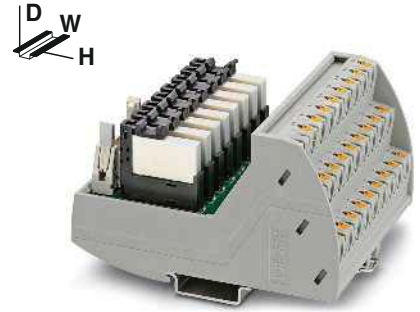

Digital input module with 8 channels for 120 V AC

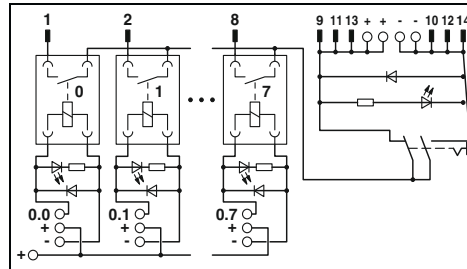

Technical data

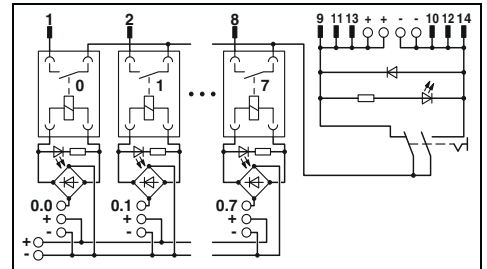

Technical data

Coil side	
Operating voltage U_N	24 V DC $\pm 10\%$ (supply, 2 A)
Typical input current at U_N	9 mA (per channel)
Typical response time at U_N	5 ms
Typical release time at U_N	8 ms
Input circuit	Free-wheeling diode
Status indicator per channel	Yellow LED
Connection method	Push-in connection
Connection data solid/stranded/AWG	0.14 ... 2.5 mm ² / 0.14 ... 2.5 mm ² / 26 - 14
Contact side	
Contact type	1 N/O contact
Contact material	AgSnO, hard gold-plated
Limiting continuous current	50 mA
Connection method	IDC/FLK pin strip
No. of pos.	14
General data	
Ambient temperature (operation)	-20°C ... 60°C
Nominal operating mode	100% operating factor
Mechanical service life	2x 10 ⁷ cycles
Standards/regulations	DIN EN 50178
Mounting position	Any
Mounting	In rows with zero spacing
Dimensions	109.8 mm / 63 mm
EMC note	Class A product, see page 583

Coil side	
Operating voltage U_N	120 V AC $\pm 10\%$ (supply, 2 A)
Typical input current at U_N	3.5 mA (per channel)
Typical response time at U_N	6 ms
Typical release time at U_N	15 ms
Input circuit	Free-wheeling diode
Status indicator per channel	Yellow LED
Connection method	Push-in connection
Connection data solid/stranded/AWG	0.14 ... 2.5 mm ² / 0.14 ... 2.5 mm ² / 26 - 14
Contact side	
Contact type	1 N/O contact
Contact material	AgSnO, hard gold-plated
Limiting continuous current	50 mA
Connection method	IDC/FLK pin strip
No. of pos.	14
General data	
Ambient temperature (operation)	-20°C ... 60°C
Nominal operating mode	100% operating factor
Mechanical service life	2x 10 ⁷ cycles
Standards/regulations	DIN EN 50178
Mounting position	Any
Mounting	In rows with zero spacing
Dimensions	109.8 mm / 63 mm
EMC note	Class A product, see page 583

Description	Module width W
VARIOFACE interface module , for eight channels,	
24 V DC (incl. relays)	92.7
120 V AC (incl. relays)	92.7

Ordering data		
Type	Order No.	Pcs./Pkt.
VIP-8RPT-24DC/1AU/DI/PLC	2903600	1

Ordering data		
Type	Order No.	Pcs./Pkt.
VIP-8RPT-120AC/1AU/DI/PLC	2904576	1



PLC-V8 adapters

The system cabling adapter allows fast and error-free connection of eight relay channels to the control level. This solution combines the product features of the PLC-INTERFACE and VARIOFACE system cabling relay family.

The advantages:

- High flexibility, because the modular design enables channel-specific configuration of the relay module
- Plug-in relays can be quickly replaced during maintenance work
- Space-saving wiring in the control cabinet thanks to compact design (eight channels on 50 mm)
- Sensor and actuator series enables direct connection of supply and return conductors
- Simple potential distribution using plug-in bridges

A cross-reference list with matching PLC-INTERFACE components is available for help in selecting the different functions: see Page 534.

Coupling to digital OUTPUT cards

V8 adapters with the designation “PLC-V8/.../OUT...” can be coupled to digital OUTPUT cards. This adapter plugs into eight PLC-INTERFACE boards (see “PLC Universal Series” or “PLC Actuator Series” at right).

Ordering example:

One OUTPUT V8 adapter for eight relays (coil: 24 V DC; power changeover contact: 230 V AC/6 A) with Push-in connection technology.
 1 pc. [2295554](#) PLC-V8/FLK14/OUT
 8 pcs. [2900299](#) PLC-RPT-24DC/21

Coupling to digital INPUT cards

“PLC-V8/.../IN...” type adapters connect digital INPUT cards with eight PLC-INTERFACE boards (see “PLC Sensor Series” at right).

Ordering example:

One INPUT V8 adapter for eight relays (coil: 230 V AC/DC; signal N/O contact: 24 V DC/50 mA) with screw connection technology.
 1 pc. [2296553](#) PLC-V8/FLK14/IN
 8 pcs. [2966333](#) PLC-RSC-230UC/1AU/SEN



The flexible unit with plug-in relays

Different functions can be selected for each channel:

- Electromechanical relay
- Solid-state relays
- Feed-through connection

Connection technology options include screw and Push-in connection.



Available in two overall widths

In addition to the narrow relay boards (6.2 mm), 14 mm-wide boards are also available for high currents.

This means that eight relay channels in combination with the V8 adapter can yield overall widths of 50 mm and 112 mm with high performance.



Variety of system connection options

Choose from among the following connector options as system connections for assembled cables:

- IDC/FLK, 14-pos.
- D-SUB socket strip, 15-pos.
- D-SUB male strip, 15-pos.

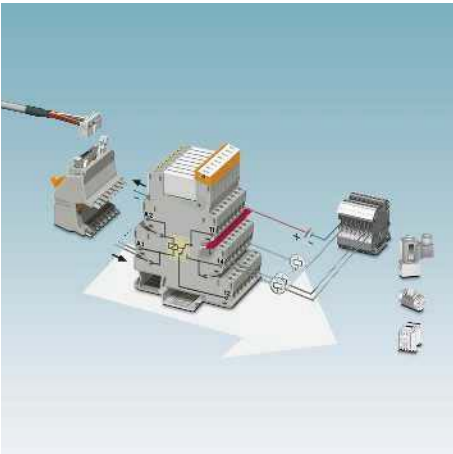

PLC universal series

The Universal series can be used as an input or output interface. Each product consists of a basic terminal block with a pluggable miniature relay (changeover contact) or a pluggable solid-state relay.

The V8 OUTPUT adapter is plugged into the eight-relay board bridge shafts on the coil side.

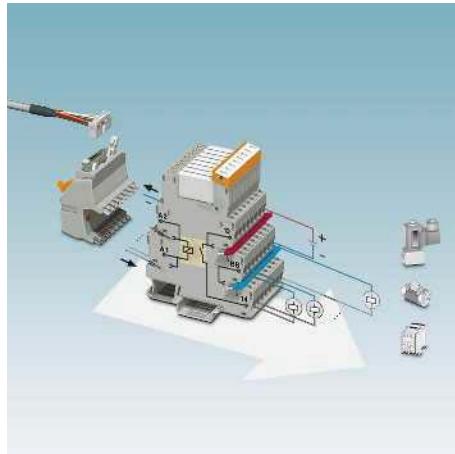

PLC actuator series

When used as an interface between the PLC and actuators, such as motors, contactors or solenoid valves, only one N/O contact function is normally required. The PLC...ACT output interface is used here. All actuator connections, including the load return line, are connected directly. This eliminates the need for additional output terminal blocks.

The V8 OUTPUT adapter is plugged into the eight-relay board bridge shafts on the coil side.

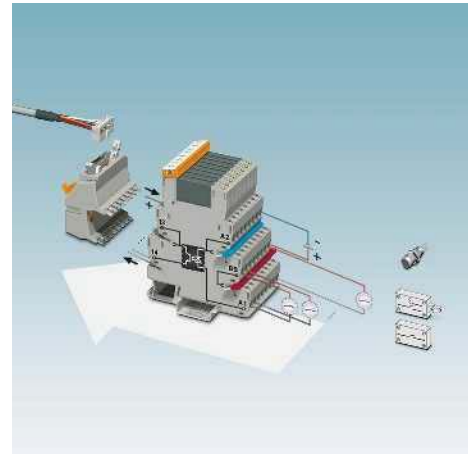

PLC sensor series

When used as an interface between the PLC and sensors, such as proximity switches, limit switches or auxiliary contacts, often only one N/O contact function is required. The PLC...SEN input interface is used here. All sensor connections, including the supply voltage for the sensors and switches, are connected directly. This eliminates the need for additional terminal blocks.

The V8 INPUT adapter is plugged into the eight relay board bridge shafts on the contact side.

System cabling for controllers

Controller-specific system cabling

Adapters for PLC-INTERFACE (6.2 mm)

PLC-V8/... are the VARIOFACE adapters connecting the eight slim 6.2 mm PLC-INTERFACE modules to the VARIOFACE system cabling:

- Can be plugged into the bridge shafts of eight aligned PLC-INTERFACE modules
- Freely definable configuration with relays, optocouplers and passive feed-through terminal blocks
- With D-SUB connection as an option for universal connections

PLC-V8/.../OUT(M)

V8 adapter for coupling to digital OUTPUT cards

PLC-V8/.../IN(M)

V8 adapter for coupling to digital INPUT cards

Notes:

Cross list with matching PLC-INTERFACE modules, see page 534



VARIOFACE adapter for 6.2 mm PLC-INTERFACE



Technical data

Maximum permissible operating voltage	30 V DC
Maximum permissible operating voltage UL / CSA	24 V / -
Maximum permissible current (per branch)	1 A (per signal path)
Maximum total current (voltage supply)	3 A
Ambient temperature (operation)	-40°C ... 70°C
Standards/regulations	IEC 60664, DIN EN 50178
Connection method	Controller level Supply
Connection data solid/stranded/AWG	IDC/FLK pin strip Screw connection 0.2 ... 4 mm ² / 0.2 ... 2.5 mm ² / 24 - 12
Dimensions	H / D 39 mm / 56 mm

Ordering data

Description	No. of pos.	Module width W	Type	Order No.	Pcs./Pkt.
V8 adapter, for 8 PLC-INTERFACES (6.2 mm), with IDC/FLK pin strip, for PLC system cabling, positive switching					
Output	14	50 mm	PLC-V8/FLK14/OUT	2295554	1
Input	14	50 mm	PLC-V8/FLK14/IN	2296553	1
V8 adapter, for 8 PLC-INTERFACES (6.2 mm), with IDC/FLK pin strip, for PLC system cabling, negative switching					
Output	14	50 mm	PLC-V8/FLK14/OUT/M	2304102	1
Input	14	50 mm	PLC-V8/FLK14/IN/M	2304115	1
V8 output adapter, for 8 PLC-INTERFACES (6.2 mm), with D-SUB connection					
Pin strip	15	50 mm	PLC-V8/D15S/OUT	2296058	1
Socket strip	15	50 mm	PLC-V8/D15B/OUT	2296061	1
V8 input adapter, for 8 PLC-INTERFACES (6.2 mm), with D-SUB connection					
Pin strip	15	50 mm	PLC-V8/D15S/IN	2296074	1
Socket strip	15	50 mm	PLC-V8/D15B/IN	2296087	1

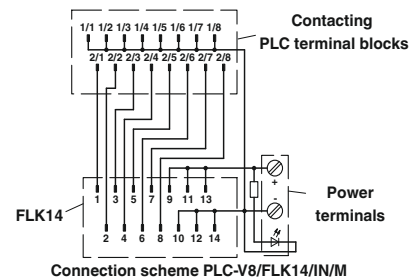
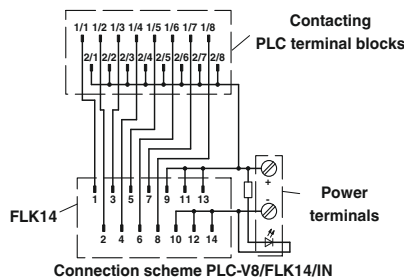
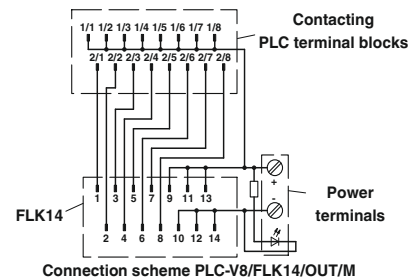
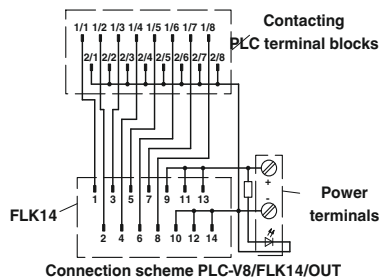

Adapters for PLC-INTERFACE (14 mm)

- PLC-V8L/...** are the VARIOFACE adapters connecting the eight 14 mm PLC-INTERFACE modules (2 PDT, HC, and IC types) to the system cabling:
- Can be plugged into the bridge shafts of eight aligned PLC-INTERFACE modules
 - Freely selectable assembly with relays or optocouplers
 - Coupling to digital OUTPUT cards

Notes:

Cross list with matching PLC-INTERFACE modules, see page 534



VARIOFACE adapter for 14 mm PLC-INTERFACE



Technical data

Maximum permissible operating voltage	30 V DC
Maximum permissible operating voltage UL / CSA	24 V / -
Maximum permissible current (per branch)	1 A (per signal path)
Maximum total current (voltage supply)	3 A
Ambient temperature (operation)	-40°C ... 70°C
Mounting position	Any
Standards/regulations	IEC 60664, DIN EN 50178
Connection method	Controller level Supply IDC/FLK pin strip
Connection data solid/stranded/AWG	Screw connection 0.2 ... 4 mm ² / 0.2 ... 2.5 mm ² / 24 - 12
Dimensions	H / D 39 mm / 56 mm

Ordering data

Description	No. of pos.	Module width W	Type	Order No.	Pcs./Pkt.
V8 adapter, for 8 PLC-INTERFACES (14 mm), with IDC/FLK pin strip, for PLC system cabling, positive switching	14	112.5 mm	PLC-V8L/FLK14/OUT	2299660	1
V8 adapter, for 8 PLC-INTERFACES (14 mm), with IDC/FLK pin strip, for PLC system cabling, negative switching	14	112.5 mm	PLC-V8L/FLK14/OUT/M	2304306	1

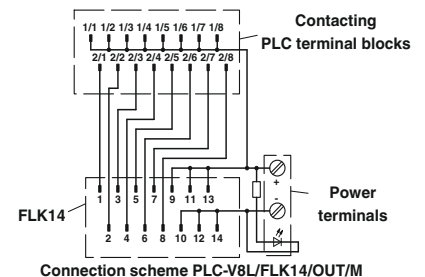
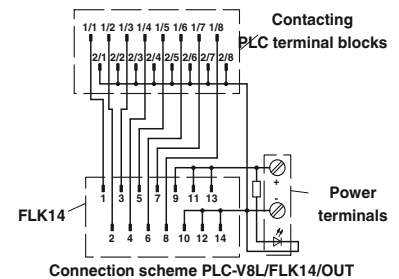

Controller-specific system cabling

Feed-through terminal blocks for PLC-INTERFACE

The VARIOFACE PLC-VT terminals are passive feed-through terminal blocks, with the same shape as the 6.2 mm slim relay and optocoupler interfaces PLC-INTERFACE. It is thus possible to implement 8-channel interface blocks for the system cabling, which can be adapted to a bit for the particular application. For individual requirements, the relay, optocoupler or the PLC-VT terminal blocks for passive signal transmission can be combined as needed.

PLC-VT PLC-VT/LA

- Can be combined with PLC-INTERFACE universal series
- Signal path with additional potential level for free assignment (two-conductor connection)
- Optionally with LED
-
-
-
-
-
-

PLC-VT/ACT PLC-VT/ACT/LA

- Can be combined with PLC-INTERFACE actuator series
 - Signal path with two additional potential levels for free assignment (three-conductor connection)
 - Optionally with LED
- The system connection is made via the PLC-V8 adapter.



VARIOFACE feed-through terminal block for PLC-INTERFACE universal series



Technical data

PLC-VT, PLC-VT/ACT	PLC-VT/LA, PLC-VT/ACT/LA
250 V AC/DC	30 V DC
220 V / -	20 V / -
6 A (per signal conductor)	6 A (per signal conductor)
-40°C ... 70°C	-40°C ... 70°C
Any	Any
DIN EN 50178, IEC 60664	
0.2 ... 4 mm ² / 0.2 ... 2.5 mm ² / 24 - 12	
80 mm / 94 mm	

Ordering data

Type	Order No.	Pcs./Pkt.
PLC-VT	2296870	10
PLC-VT/LA	2296854	10
PLC-VT/ACT	2295567	10
PLC-VT/ACT/LA	2296867	10

Maximum permissible operating voltage	
Maximum permissible operating voltage UL / CSA	
Maximum permissible current (per branch)	
Ambient temperature (operation)	
Mounting position	
Standards/regulations	
Connection data solid/stranded/AWG	
Dimensions	H / D

Description	No. of pos.	Module width W
VARIOFACE feed-through terminal block (two-conductor connection), for PLC-INTERFACE universal series		6.2 mm
VARIOFACE feed-through terminal block, same as before, however, with 24 V DC light indicator		6.2 mm
VARIOFACE feed-through terminal block (three-conductor connection), for PLC INTERFACE actuator series		6.2 mm
VARIOFACE feed-through terminal block, same as before, however, with 24 V DC light indicator		6.2 mm



Connection scheme PLC-VT

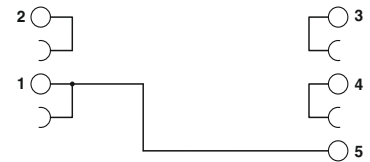

Connection scheme PLC-VT/ACT

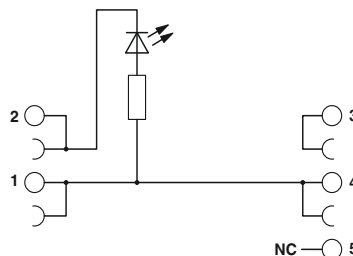

Connection scheme PLC-VT/LA

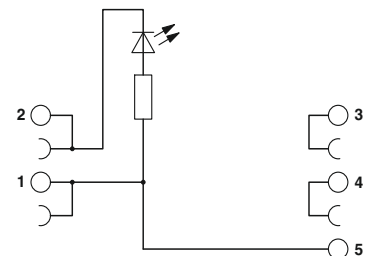

Connection scheme PLC-VT/ACT/LA

Adapters for RIFLINE complete RF-1

RIF-1-V8/... if they are VARIOFACE adapters, connect the eight RIF-1 relay modules with the system cabling:

- Can be plugged in to eight RIF-1 relay modules in series
- The adapter has one LED indicator and one freewheeling diode per relay

The following RIF-1 relay modules can be connected with the adapters:

With Push-in connection:

- RIF-1-RPT-LDP-24DC/1IC, Order No. [2909884*](#)
- RIF-1-BPT/2X21, Order No. [2900931](#)
- RIF-1-RPT-LDP-24DC/1X21, Order No. [2903342*](#)
- RIF-1-RPT-LDP-24DC/1X21 AU, Order No. [2903338*](#)
- RIF-1-RPT-LDP-24DC/2X21, Order No. [2903334*](#)
- RIF-1-RPT-LDP-24DC/2X21 AU, Order No. [2903330*](#)
- RIF-1-RPT-LDP-24DC/1X21MS, Order No. [2905289](#)
- RIF-1-RPT-LDP-24DC/2X21MS, Order No. [2905291](#)

With screw connection:

- RIF-1-RSC-LDP-24DC/1IC, Order No. [2909885*](#)
- RIF-1-BSC/2X21, Order No. [2900930](#)
- RIF-1-RSC-LDP-24DC/1X21, Order No. [2903358*](#)
- RIF-1-RSC-LDP-24DC/1X21 AU, Order No. [2903354*](#)
- RIF-1-RSC-LDP-24DC/2X21, Order No. [2903350*](#)
- RIF-1-RSC-LDP-24DC/2X21 AU, Order No. [2903346*](#)
- RIF-1-RSC-LDP-24DC/1X21MS, Order No. [2905659](#)
- RIF-1-RSC-LDP-24DC/2X21MS, Order No. [2905660](#)

* If completely assembled RIF-1 relay modules are used, the indicator/interference suppression modules must be removed before installation.



VARIOFACE adapter for RIFLINE complete RIF-1



Technical data

Maximum permissible operating voltage	30 V DC
Maximum permissible operating voltage UL / CSA	24 V / -
Maximum permissible current (per branch)	1 A (per signal path)
Maximum total current (voltage supply)	3 A
Ambient temperature (operation)	-40°C ... 60°C
Mounting position	Any
Standards/regulations	IEC 60664, DIN EN 50178
Connection method	Controller level IDC/FLK pin strip
	Supply Push-in connection
Connection data solid/stranded/AWG	0.2 ... 1.5 mm ² / 0.2 ... 1.5 mm ² / 24 - 16
Dimensions	H / D 101 mm / 75 mm

Ordering data

Description	No. of pos.	Module width W	Type	Order No.	Pcs./Pkt.
V8 adapter , for eight RIF-1 relay modules, with IDC/FLK pin strip for PLC system cabling, positive switching	14	128 mm	RIF-1-V8/PT/FLK14/OUT	2905195	1

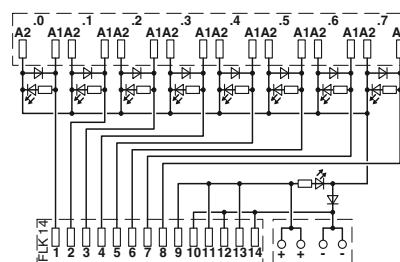

Connection scheme for RIF-1-V8/PT/FLK14/OUT

Cross-reference list for PLC-V8 adapters with matching PLC-INTERFACE modules

Series	Function	Contact	Input	Output	Page
Universal	Relay	1 changeover contact	24 V DC	250 V AC/DC / 6 A	364
			24 V DC	250 V AC/DC / 10 A	384
			12 V DC	30 V AC/36 V DC / 50 mA	365
			24 V DC	30 V AC/36 V DC / 50 mA	365
			24 V AC/DC	30 V AC/36 V DC / 50 mA	365
			48 V DC	30 V AC/36 V DC / 50 mA	365
			60 V DC	30 V AC/36 V DC / 50 mA	365
			120 V AC/DC	30 V AC/36 V DC / 50 mA	365
			230 V AC/DC	30 V AC/36 V DC / 50 mA	365
			120 V AC	30 V AC/36 V DC / 50 mA ¹⁾	388
			230 V AC	30 V AC/36 V DC / 50 mA ¹⁾	388
		24 V DC	250 V AC/DC / 6 A	365	
		24 V DC	250 V AC/DC / 10 A	369	
		12 V DC	30 V AC/36 V DC / 50 mA	365	
		24 V DC	30 V AC/36 V DC / 50 mA	365	
		24 V AC/DC	30 V AC/36 V DC / 50 mA	365	
		120 V AC/DC	30 V AC/36 V DC / 50 mA	365	
		230 V AC/DC	30 V AC/36 V DC / 50 mA	365	
		2 changeover contacts	24 V DC	250 V AC/DC / 6 A	366
			24 V DC	30 V AC/DC / 50 mA	367
		2 changeover contacts with manual operation	24 V DC	250 V AC/DC / 6 A	368
		24 V DC	30 V AC/36 V DC / 50 mA	369	
	Relay switch	1 N/O contact	24 V AC/DC	250 V AC/DC / 6 A	406
			24 V AC/DC	250 V AC/DC / 6 A	406
	Optocoupler	1 N/O contact, electronic	24 V DC	24 V DC / 3 A	373
			24 V DC	24 V DC / 10 A	409
			24 V DC	250 V AC / 0.75 A	373
			24 V DC	300 V DC / 1 A	408
			24 V DC	48 V DC / 100 mA	372
			48 V DC	48 V DC / 100 mA	372
			60 V DC	48 V DC / 100 mA	372
			120 V AC/DC	48 V DC / 100 mA	372
			230 V AC/DC	48 V DC / 100 mA	372
NAMUR			24 V DC / 50 mA	422	
120 V AC			48 V DC / 100 mA ²⁾	388	
230 V AC			48 V DC / 100 mA ²⁾	388	
1 changeover contact, electronic		24 V DC	48 V DC / 0.5 A	409	
Feed-through	-	250 V AC/DC	250 V AC/DC	532	
		24 V DC	24 V DC	532	
Actuator	Relay	1 N/O contact	24 V DC	250 V AC/DC / 6 A	374
			24 V DC	250 V AC/DC / 10 A (80 A, 20 ms)	382
		1 N/O contact with manual operation	24 V DC	250 V AC/DC / 6 A	375
		2 N/O contacts	24 V DC	250 V AC/DC / 6 A	375
	Optocoupler	1 N/O contact, electronic	24 V DC	24 V DC / 3 A	376
			24 V DC	24 V DC / 5 A	378
			24 V DC	250 V AC / 0.75 A	377
	Feed-through	-	24 V DC	250 V AC / 2 A	378
250 V AC/DC			250 V AC/DC	532	
		24 V DC	24 V DC	532	
Sensor ³⁾	Relay	1 N/O contact	24 V DC	30 V AC/36 V DC / 50 mA	380
			120 V AC/DC	30 V AC/36 V DC / 50 mA	380
			230 V AC/DC	30 V AC/36 V DC / 50 mA	380
		120 V AC	30 V AC/36 V DC / 50 mA ¹⁾	389	
		230 V AC	30 V AC/36 V DC / 50 mA ¹⁾	389	
		24 V DC	30 V AC/36 V DC / 50 mA	381	
	1 N/O contact with manual operation	120 V AC/DC	30 V AC/36 V DC / 50 mA	381	
		230 V AC/DC	30 V AC/36 V DC / 50 mA	381	
		24 V DC	48 V DC / 100 mA	381	
	Optocoupler	1 N/O contact, electronic	120 V AC/DC	48 V DC / 100 mA	381
			230 V AC/DC	48 V DC / 100 mA	381
			120 V AC	48 V DC / 100 mA ²⁾	389
		230 V AC	48 V DC / 100 mA ²⁾	389	

1) Plug-in miniature relay insert: REL-MR-60DC/21AU, [2961134](#)

2) Plug-in solid-state relay insert: OPT-60DC/48DC/100, [2966621](#)

3) PLC-...SO46 is supplied as a basic terminal block with filter, but without relay or solid-state relay.

4) Cannot be mixed with the Universal series (within a byte)



Push-in connection



Screw connection

PLC-V8...OUT/(M)

PLC-V8...IN/(M)

PLC-V8L...OUT

Order No.:

Order No.:

	Order No.:		Order No.:	PLC-V8...OUT/(M)	PLC-V8...IN/(M)	PLC-V8L...OUT
PLC-RPT-24DC/21	2900299	PLC-RSC-24DC/21	2966171	✓		
PLC-RPT-24DC/21HC	2900291	PLC-RSC-24DC/21HC	2967620			✓
PLC-RPT-12DC/21AU	2900317	PLC-RSC-12DC/21AU	2966919		✓	
PLC-RPT-24DC/21AU	2900306	PLC-RSC-24DC/21AU	2966265	✓	✓	
PLC-RPT-24UC/21AU	2900307	PLC-RSC-24UC/21AU	2966278	✓	✓	
PLC-RPT-48DC/21AU	2900308	PLC-RSC-48DC/21AU	2966126	✓	✓	
PLC-RPT-60DC/21AU	2900309	PLC-RSC-60DC/21AU	2966142		✓	
PLC-RPT-120UC/21AU	2900310	PLC-RSC-120UC/21AU	2966281		✓	
PLC-RPT-230UC/21AU	2900311	PLC-RSC-230UC/21AU	2966294		✓	
PLC-RPT-120UC/21/SO46	2900453 ³⁾	PLC-BSC-120UC/21/SO46	2980319 ³⁾		✓	
PLC-RPT-230UC/21/SO46	2900455 ³⁾	PLC-BSC-230UC/21/SO46	2980335 ³⁾		✓	
PLC-RPT-24DC/21/MS	2909667	PLC-RSC-24DC/21/MS	2909649	✓		
PLC-RPT-24DC/21HC/MS	2910530	PLC-RSC-24DC/21HC/MS	2910514			✓
PLC-RPT-12DC/21AU/MS	2909671	PLC-RSC-12DC/21AU/MS	2909654		✓	
PLC-RPT-24DC/21AU/MS	2909672	PLC-RSC-24DC/21AU/MS	2909655	✓	✓	
PLC-RPT-24UC/21AU/MS	2909673	PLC-RSC-24UC/21AU/MS	2909656	✓	✓	
PLC-RPT-120UC/21AU/MS	2909674	PLC-RSC-120UC/21AU/MS	2909657		✓	
PLC-RPT-230UC/21AU/MS	2909676	PLC-RSC-230UC/21AU/MS	2909660		✓	
PLC-RPT-24DC/21-21	2900330	PLC-RSC-24DC/21-21	2967060			✓
PLC-RPT-24DC/21-21AU	2900338	PLC-RSC-24DC/21-21AU	2967125			✓
PLC-RPT-24DC/21-21/MS	2910519	PLC-RSC-24DC/21-21/MS	2910502			✓
PLC-RPT-24DC/21-21AU/MS	2910524	PLC-RSC-24DC/21-21AU/MS	2910507			✓
PLC-RPT-24UC/1/S/H	2900328	PLC-RSC-24UC/1/S/H	2982236	✓		
PLC-RPT-24UC/1/S/L	2900327	PLC-RSC-24UC/1/S/L	2834876	✓		
PLC-OPT-24DC/24DC/2	2900364	PLC-OSC-24DC/24DC/2	2966634	✓		
PLC-OPT-24DC/24DC/10/R	2900398	PLC-OSC-24DC/24DC/10/R	2982702	✓		
PLC-OPT-24DC/230AC/1	2900369	PLC-OSC-24DC/230AC/1	2967840	✓		
PLC-OPT-24DC/300DC/1	2900383	PLC-OSC-24DC/300DC/1	2980678	✓		
PLC-OPT-24DC/48DC/100	2900352	PLC-OSC-24DC/48DC/100	2966728	✓	✓	
PLC-OPT-48DC/48DC/100	2900353	PLC-OSC-48DC/48DC/100	2966993		✓	
PLC-OPT-60DC/48DC/100	2900354	PLC-OSC-60DC/48DC/100	2967455		✓	
PLC-OPT-120UC/48DC/100	2900355	PLC-OSC-120UC/48DC/100	2966744		✓	
PLC-OPT-230UC/48DC/100	2900356	PLC-OSC-230UC/48DC/100	2966757		✓	
PLC-PT-EIK 1-SVN 24P/P	2900397	PLC-SC-EIK 1-SVN 24P/P	2982663	✓		
PLC-BPT-120UC/21/SO46	2900453 ³⁾	PLC-BSC-120UC/21/SO46	2980319 ³⁾		✓	
PLC-BPT-230UC/21/SO46	2900455 ³⁾	PLC-BSC-230UC/21/SO46	2980335 ³⁾		✓	
PLC-OPT-24DC/48DC/500/W	2900378	PLC-OSC-24DC/48DC/500/W	2980636	✓		
-		PLC-VT	2296870	✓	✓	
-		PLC-VT/LA	2296854	✓	✓	
PLC-RPT-24DC/1/ACT	2900312	PLC-RSC-24DC/1/ACT	2966210	✓		
PLC-RPT-24DC/11C/ACT	2900298	PLC-RSC-24DC/11C/ACT	2967604			✓
PLC-RPT-24DC/1/MS/ACT	2909677	PLC-RSC-24DC/1/MS/ACT	2909661	✓		
-		PLC-RSC-24DC/1-1/ACT	2967109			✓
PLC-OPT-24DC/24DC/2/ACT	2900376	PLC-OSC-24DC/24DC/2/ACT	2966676	✓		
-		PLC-OSC-24DC/24DC/5/ACT	2982786			✓
-		PLC-OSC-24DC/230AC/1/ACT	2967947	✓		
-		PLC-OSC-24DC/230AC/2/ACT	2982760			✓
-		PLC-VT/AKT	2295567	✓		
-		PLC-VT/AKT/LA	2296867	✓		
PLC-RPT-24DC/1AU/SEN	2900313	PLC-RSC-24DC/1AU/SEN	2966317		✓	
PLC-RPT-120UC/1AU/SEN	2900314	PLC-RSC-120UC/1AU/SEN	2966320		✓	
PLC-RPT-230UC/1AU/SEN	2900315	PLC-RSC-230UC/1AU/SEN	2966333		✓	
PLC-BPT-120UC/1/SEN/SO46	2900456 ³⁾	PLC-BSC-120UC/1/SEN/SO46	2980322 ³⁾		✓	
PLC-BPT-230UC/1/SEN/SO46	2900457 ³⁾	PLC-BSC-230UC/1/SEN/SO46	2980348 ³⁾		✓	
PLC-RPT-24DC/1AU/MS/SEN	2909678	PLC-RSC-24DC/1AU/MS/SEN	2909663	✓		
PLC-RPT-120UC/1AU/MS/SEN	2909679	PLC-RSC-120UC/1AU/MS/SEN	2909664	✓		
PLC-RPT-230UC/1AU/MS/SEN	2909680	PLC-RSC-230UC/1AU/MS/SEN	2909665	✓		
PLC-OPT-24DC/48DC/100/SEN	2900358	PLC-OSC-24DC/48DC/100/SEN	2966773	✓		
PLC-OPT-120UC/48DC/100/SEN	2900359	PLC-OSC-120UC/48DC/100/SEN	2966799	✓		
PLC-OPT-230UC/48DC/100/SEN	2900361	PLC-OSC-230UC/48DC/100/SEN	2966809	✓		
PLC-BPT-120UC/1/SEN/SO46	2900456 ³⁾	PLC-BSC-120UC/1/SEN/SO46	2980322 ³⁾		✓	
PLC-BPT-230UC/1/SEN/SO46	2900457 ³⁾	PLC-BSC-230UC/1/SEN/SO46	2980348 ³⁾		✓	

System cabling for controllers

Controller-specific system cabling

System cables with IDC/FLK socket strips

- 1:1 connection
- 14 and 50-pos.
- Connectors as per IEC 60603-13
- Shielded or unshielded
- Halogen-free see page 565
- Special lengths see page 569



Not shielded



Shielded with shield connection on one end



	Technical data	Technical data
Maximum permissible operating voltage	25 V AC / 60 V DC	25 V AC / 60 V DC
Maximum permissible operating voltage UL / CSA	125 V / -	125 V / -
Maximum permissible current carrying capacity per path	-	-
Maximum conductor resistance	0.16 Ω/m	0.16 Ω/m
Ambient temperature (operation)	-20°C ... 50°C	-20°C ... 50°C
Shield	-	Tinned copper-braided shield, approx. 85% covering
Conductor cross section	AWG 26 / 0.14 mm ²	AWG 26 / 0.14 mm ²
Conductor structure: stranded wires / material	7 / Cu tin-plated	7 / Cu tin-plated
Outside diameter	6.4 mm	6.7 mm
Outside diameter	6.4 mm	6.7 mm

			Ordering data			Ordering data		
Description	No. of pos.	Cable length	Type	Order No.	Pcs./Pkt.	Type	Order No.	Pcs./Pkt.
Assembled round cable, with two 14-pos. IDC/FLK socket strips in fixed lengths for transfer of 8 channels								
	14	0.3 m	FLK 14/EZ-DR/ 30/KONFEK	2295729	5			
	14	0.5 m	FLK 14/EZ-DR/ 50/KONFEK	2288901	5	FLK 14/EZ-DR/ 50/KONFEK/S	2296977	1
	14	1 m	FLK 14/EZ-DR/ 100/KONFEK	2288914	1	FLK 14/EZ-DR/ 100/KONFEK/S	2296980	1
	14	1.5 m	FLK 14/EZ-DR/ 150/KONFEK	2288927	1	FLK 14/EZ-DR/ 150/KONFEK/S	2296993	1
	14	2 m	FLK 14/EZ-DR/ 200/KONFEK	2288930	1	FLK 14/EZ-DR/ 200/KONFEK/S	2297002	1
	14	2.5 m	FLK 14/EZ-DR/ 250/KONFEK	2288943	1			
	14	3 m	FLK 14/EZ-DR/ 300/KONFEK	2288956	1	FLK 14/EZ-DR/ 300/KONFEK/S	2299013	1
	14	3.5 m	FLK 14/EZ-DR/ 350/KONFEK	2288969	1			
	14	4 m	FLK 14/EZ-DR/ 400/KONFEK	2288972	1	FLK 14/EZ-DR/ 400/KONFEK/S	2299026	1
	14	4.5 m	FLK 14/EZ-DR/ 450/KONFEK	2290847	1			
	14	5 m	FLK 14/EZ-DR/ 500/KONFEK	2290834	1			
	14	5.5 m	FLK 14/EZ-DR/ 550/KONFEK	2290850	1			
	14	6 m	FLK 14/EZ-DR/ 600/KONFEK	2290863	1	FLK 14/EZ-DR/ 600/KONFEK/S	2299039	1
	14	8 m	FLK 14/EZ-DR/ 800/KONFEK	2299563	1	FLK 14/EZ-DR/ 800/KONFEK/S	2299042	1
	14	10 m	FLK 14/EZ-DR/1000/KONFEK	2299576	1	FLK 14/EZ-DR/1000/KONFEK/S	2299055	1
Assembled round cable, with two 50-pos. IDC/FLK socket strips in fixed lengths for transfer of 32 channels								
	50	0.5 m	FLK 50/EZ-DR/ 50/KONFEK	2289065	5	FLK 50/EZ-DR/ 50/KONFEK/S	2299097	1
	50	1 m	FLK 50/EZ-DR/ 100/KONFEK	2289078	1	FLK 50/EZ-DR/ 100/KONFEK/S	2299107	1
	50	1.5 m	FLK 50/EZ-DR/ 150/KONFEK	2289081	1	FLK 50/EZ-DR/ 150/KONFEK/S	2299110	1
	50	2 m	FLK 50/EZ-DR/ 200/KONFEK	2289094	1	FLK 50/EZ-DR/ 200/KONFEK/S	2299123	1
	50	2.5 m	FLK 50/EZ-DR/ 250/KONFEK	2289104	1			
	50	3 m	FLK 50/EZ-DR/ 300/KONFEK	2289117	1	FLK 50/EZ-DR/ 300/KONFEK/S	2299136	1
	50	3.5 m	FLK 50/EZ-DR/ 350/KONFEK	2289120	1			
	50	4 m	FLK 50/EZ-DR/ 400/KONFEK	2289133	1	FLK 50/EZ-DR/ 400/KONFEK/S	2299149	1
	50	4.5 m	FLK 50/EZ-DR/ 450/KONFEK	2289573	1			
	50	5 m	FLK 50/EZ-DR/ 500/KONFEK	2289586	1			
	50	5.5 m	FLK 50/EZ-DR/ 550/KONFEK	2289599	1			
	50	6 m	FLK 50/EZ-DR/ 600/KONFEK	2289609	1	FLK 50/EZ-DR/ 600/KONFEK/S	2299152	1
	50	6.5 m	FLK 50/EZ-DR/ 650/KONFEK	2289612	1			
	50	7 m	FLK 50/EZ-DR/ 700/KONFEK	2289625	1			
	50	7.5 m	FLK 50/EZ-DR/ 750/KONFEK	2289638	1			
	50	8 m	FLK 50/EZ-DR/ 800/KONFEK	2289641	1	FLK 50/EZ-DR/ 800/KONFEK/S	2299165	1
	50	8.5 m	FLK 50/EZ-DR/ 850/KONFEK	2289654	1			
	50	9 m	FLK 50/EZ-DR/ 900/KONFEK	2289667	1			
	50	9.5 m	FLK 50/EZ-DR/ 950/KONFEK	2289670	1			
	50	10 m	FLK 50/EZ-DR/1000/KONFEK	2289683	1	FLK 50/EZ-DR/1000/KONFEK/S	2299178	1

Splitting cables with IDC/FLK socket strips

- Splitting of 32 channels to 4 x 8 channels
- 50-pos. connector at one end
- 4 x 14-pos. connector at one end
- Connectors as per IEC 60603-13
- Shielded or unshielded
- Special lengths



Splitting cable unshielded
50 positions on 4 x 14



Splitting cable shielded
50 positions on 4 x 14



Technical data

Maximum permissible operating voltage	25 V AC / 60 V DC
Maximum permissible operating voltage UL / CSA	125 V / -
Maximum permissible current carrying capacity per path	1 A
Maximum conductor resistance	0.16 Ω/m
Ambient temperature (operation)	-20°C ... 50°C
Shield	-

Assembly: Insulation displacement, IEC 60352-4/DIN EN 60352-4

Conductor cross section	AWG 26 / 0.14 mm ²
Conductor structure: stranded wires / material	7 / Cu tin-plated
Number of plugs on the module side	4
Outside diameter	6.3 mm

50 -position



Technical data

Maximum permissible operating voltage	25 V AC / 60 V DC
Maximum permissible operating voltage UL / CSA	125 V / -
Maximum permissible current carrying capacity per path	1 A
Maximum conductor resistance	0.16 Ω/m
Ambient temperature (operation)	-20°C ... 50°C
Shield	Tinned copper-braided shield, approx. 85% covering

Insulation displacement, IEC 60352-4/DIN EN 60352-4

Conductor cross section	AWG 26 / 0.14 mm ²
Conductor structure: stranded wires / material	7 / Cu tin-plated
Number of plugs on the module side	4
Outside diameter	6.3 mm

6.3 mm

Ordering data

Description	No. of pos.	Cable length	Type	Order No.	Pcs./Pkt.
Assembled round cable , with a 50-pos. IDC/FLK socket strip and four 14-pos. IDC/FLK socket strips, for splitting 32 channels into 4 x 8 channels.	50	0.5 m	FLK 50/4X14/EZ-DR/ 50/KONFEK	2296689	1
	50	1 m	FLK 50/4X14/EZ-DR/ 100/KONFEK	2296692	1
	50	1.5 m	FLK 50/4X14/EZ-DR/ 150/KONFEK	2296702	1
	50	2 m	FLK 50/4X14/EZ-DR/ 200/KONFEK	2296715	1
	50	2.5 m	FLK 50/4X14/EZ-DR/ 250/KONFEK	2305402	1
	50	3 m	FLK 50/4X14/EZ-DR/ 300/KONFEK	2296728	1
	50	4 m	FLK 50/4X14/EZ-DR/ 400/KONFEK	2296731	1
	50	6 m	FLK 50/4X14/EZ-DR/ 600/KONFEK	2296744	1
	50	8 m	FLK 50/4X14/EZ-DR/ 800/KONFEK	2296757	1
	50	10 m	FLK 50/4X14/EZ-DR/1000/KONFEK	2296773	1
	Assembled round cables , same as before, however in variable lengths	50		FLK 50-4X14-EZ-DR ...	2302405

Ordering data

Type	Order No.	Pcs./Pkt.
FLK 50-4X14-EZ-DR-S ...	2302447	1

Ordering example for system cable:

- Unshielded splitting cable 12.75 m long

Quantity	Order No.	Length [m] ¹⁾
1	2302405	12.75

¹⁾ min. 0.30 m

- Shielded splitting cable 11.00 m long

Quantity	Order No.	Length [m] ¹⁾
1	2302447	11.00

¹⁾ min. 0.30 m



Intermediate adapters for SIMATIC® S5 to SIMATIC® S7-400

The S5 connector is plugged directly into the I/O card using the intermediate adapter. A new S7-400 is installed in place of the S5. The existing field wiring is retained.



Conversion adapters from SIMATIC® S5 to SIMATIC® S7-300

Using the adapters, the signals of the S5 front adapter are converted to a 50-pos. strip. The signals are routed to the S7-300 I/O module via a system cable and front adapter.



Startup adapters for test purposes

The universal startup adapters extend all signals of the existing S5 wiring. The open cable end can be connected to different controllers such as S7-400 or S7-300.

**Siemens SIMATIC® S7-300
Adapters for conversion from
S5-135/155 to S7-300**

S5-S7 adapters connect the S5-135 front adapters wired with individual wires to the I/O modules of the S7.

With the aid of the FLKM S135/S7/FLK50 converter module, the signals of the S5-135 front adapter can be converted to a 50-pos. strip. A FLK 50/EZ-DR/.../KONFEK 50-pos. system cable and a front adapter for S7-300 (FLKM 50-PA-S300) connect the signals to the I/O module.

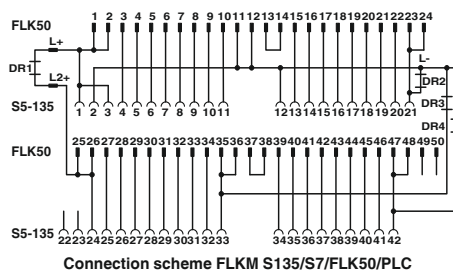

Connection scheme FLKM S135/S7/FLK50/PLC



Converter for SIMATIC® S5-135 to 50-pos. FLK strip

Notes:
Due to the geometry, it is not possible to couple any molded FLK connectors (e.g., VIP-PA...S7).

Maximum permissible operating voltage
Maximum permissible current
Ambient temperature (operation)
Ambient temperature (storage/transport)
Mounting position
Standards/regulations

60 V DC
1 A (per path)
-20°C ... 50°C
-20°C ... 70°C
Any
IEC 60664 / DIN EN 50178

Technical data

Ordering data

Description
Digital IN or OUT 24 V DC from S5-135 to S7-300
IN 6ES5 420-4UA14 to 6ES7 321-1BL00-0AA0 6ES5 430-4UA14 to 6ES7 321-1BL00-0AA0
OUT 6ES5 441-4UA14 to 6ES7 322-1BL00-0AA0 6ES5 451-4UA14 to 6ES7 322-1BL00-0AA0

Type	Order No.	Pcs./Pkt.
FLKM S135/S7/FLK50/PLC	2314736	1

**Startup adapters for extending
the existing S5-135/155 field wiring.**

All signals of the existing S5-135 wiring 3 or 5 are extended with the help of the universal commissioning adapters. The open cable end can be connected to various controllers such as S7-400 or S7-300. Thus, the existing field wiring of S5-135 can communicate with the new controller for test purposes. Since the new control unit is temporarily arranged before the control cabinet, the original status of the system can be restored if required.

The S5-135 is replaced once the system operates without errors with the new controller.

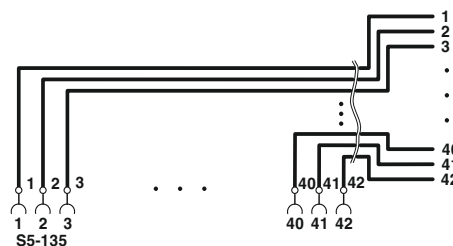

Startup adapter for S5-135/155 field wiring

Maximum permissible operating voltage
Maximum permissible current
Ambient temperature (operation)
Ambient temperature (storage/transport)
Mounting position
Standards/regulations

250 V AC/DC
6 A (per path)
-20°C ... 50°C
-20°C ... 80°C
Any
IEC 60664 / DIN EN 50178

Technical data

Ordering data

Description
Connection of all S5-135 connections (1 to 42) at the open cable end
Connection of all S5-135 connections (1 to 42) without cable

Type	Order No.	Pcs./Pkt.
FLKM S135/42X0,75/3,0M/OE	2315007	1
FLKM S135/42X0,75/5,0M/OE	2318017	1
FLKM S135/42XMKDSN	2901603	1

Retrofit and modernization components

Siemens SIMATIC® S7-400 Adapters for conversion from S5-135/155 to S7-400

The FLKM S135/... adapters directly connect an S5 connector wired with single wires to the S7-400 basic card.

The S5 connector is plugged directly into an S7-400 I/O card with the aid of the FLKM S135/... intermediate adapter.

A new S7-400 is installed in place of the S5. The existing field wiring is retained.

Attention:

The LEDs of the S7-400 module are hidden.



Adapter for digital input modules

ERIC

Technical data

Maximum permissible operating voltage
Maximum permissible current

...SO120, ...S400	...SO121
60 V DC	60 V DC
4 A (per path)	2 A (per path)
4 A (per connection, supply via separate power supply)	2 A (during supply via separate power supply)

Ambient temperature (operation)
Connection method

Field level

-20°C ... 50°C	-20°C ... 50°C
SIEMENS S5-135 U pin strip	SIEMENS S5-135 U pin strip

Standards/regulations

IEC 60664 / DIN EN 50178	IEC 60664 / DIN EN 50178
--------------------------	--------------------------

Ordering data

Description	Module width W	Type	Order No.	Pcs./Pkt.
Digital IN 24 V DC				
6ES5 420-4UA14 on 6ES7 421-1BL01-0AA0		FLKM S135/S400/SO120	2301723	1
6ES5 430-4UA14 on 6ES7 421-1BL01-0AA0		FLKM S135/S400/SO121	2301736	1
6ES5 431-4UA12 to 6ES7 421-7DH00-0AB0		FLKM S135-431-4UA/S400	2314846	1
Digital OUT 24 V DC				
6ES5 441-4UA12 to 6ES7 422-1BL00-0AA0				
6ES5 451-4UA14 to 6ES7 422-1BL00-0AA0				
Analog IN				
Pt 100				
6ES5 465-4UA13 to 6ES7 431-7KF10-0AB0				
Current and voltage measurement				
6ES5 465-4UA13 to 6ES7 431-0HH00-0AB0				
6ES5 465-4UA13 to 6ES7 431-7QH00-0AB0				
Current measurement				
6ES5 460-4UA13 to 6ES7 431-1KF00-0AB0				
Analog OUT				
Current output				
6ES5 470-4UA13 to 6ES7 432-1HF00-0AB0				
6ES5 470-4UC13 to 6ES7 432-1HF00-0AB0				
Voltage output				
6ES5 470-4UA13 to 6ES7 432-1HF00-0AB0				
6ES5 470-4UB13 to 6ES7 432-1HF00-0AB0				
6ES5 470-4UC13 to 6ES7 432-1HF00-0AB0				



Adapter for digital output modules



Adapter for analog input modules



Adapter for analog output modules

ERC

Technical data

60 V DC
4 A (per path)
4 A (per connection, supply via separate power supply)

-20°C ... 50°C
SIEMENS S5-135 U pin strip

IEC 60664 / DIN EN 50178

Ordering data

Type	Order No.	Pcs./Pkt.
FLKM S135/S400/SO125	2301778	1
FLKM S135/S400/SO126	2301781	1

ERC

Technical data

...T/S400
60 V DC
2 A (per path)
2 A (per connection, supply via separate power supply)

...UI/S400, ...I/S400
60 V DC
4 A (per path)
4 A (per connection, supply via separate power supply)

-20°C ... 50°C
SIEMENS S5-135 U pin strip

-20°C ... 50°C
SIEMENS S5-135 U pin strip

IEC 60664 / DIN EN 50178

IEC 60664 / DIN EN 50178

Ordering data

Type	Order No.	Pcs./Pkt.
FLKM S135-465-4UA/T/S400	2314875	1
FLKM S135-465-4UA/UI/S400	2314888	1
FLKM S135-460-4UA/I/S400	2314613	1

ERC

Technical data

60 V DC
4 A (per path)
4 A (per connection, supply via separate power supply)

-20°C ... 50°C
SIEMENS S5-135 U pin strip

IEC 60664 / DIN EN 50178

Ordering data

Type	Order No.	Pcs./Pkt.
FLKM S135-470-4UC/I/S400	2314626	1
FLKM S135-470-4UC/U/S400	2314891	1

Retrofit and modernization components

Siemens SIMATIC® S7-400 Adapters for conversion from S5-115 to S7-400

The FLKM S115/... adapters directly connect an S5 connector wired with single wires to the S7-400 basic card.

The S5 connector is plugged directly into an S7-400 I/O card with the aid of the FLKM S115/... intermediate adapter.

A new S7-400 is installed in place of the S5. The existing field wiring is retained.

Attention:

Due to the geometry, it is only possible to use every second slot. The LEDs of the S7-400 module are hidden by the S5-115 adapter.



Adapter for
SIMATIC® S5-115/S7-400

ERIC

Technical data

Maximum permissible operating voltage
Maximum permissible current

60 V DC
4 A (per path)
4 A (per connection, supply via separate power supply)

Ambient temperature (operation)
Ambient temperature (storage/transport)
Mounting position
Standards/regulations

-20°C ... 50°C
-20°C ... 70°C
Any
IEC 60664 / DIN EN 50178

Ordering data

Description
Digital IN or OUT 24 V DC from S5-115 to S7-400
IN 6ES5 420-7LA11 to 6ES7 421-1BL01-0AA0 6ES5 430-7LA11 to 6ES7 421-1BL01-0AA0
OUT 6ES5 441-7LA11 to 6ES7 422-1BL00-0AA0 6ES5 451-7LA11 to 6ES7 422-1BL00-0AA0

Type	Order No.	Pcs./Pkt.
FLKM S115/S400/SO155	2307248	1

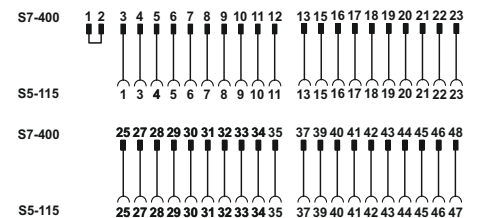

Connection scheme: FLKM S115/S400/SO155

**Siemens SIMATIC® S7-300
Adapters for conversion from
S5-115 to S7-300**

S5-S7 adapters connect the S5-115 front adapters wired with individual wires to the I/O modules of S7-300.

With the aid of the FLKM S115/S7/FLK50/SO137 converter module, the signals of the S5-115 front adapter can be converted to a 50-pos. strip. A FLK 50/EZ-DR/.../KONFEK 50-pos. system cable and a front adapter for S7-300 (FLKM 50-PA-S300) connect the signals to the I/O module.

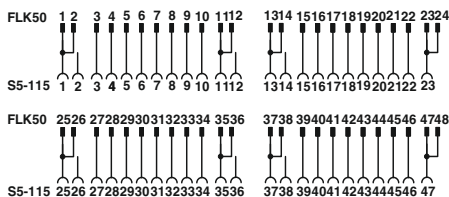

Connection scheme: FLKM S115/S7/FLK50/PLC/SO137



Converter for SIMATIC® S5-115
to 50-pos. FLK strip

Notes:
Due to the geometry, it is not possible to couple any molded FLK connectors (e.g., VIP-PA...S7).

Maximum permissible operating voltage
Maximum permissible current
Maximum permissible total current
Ambient temperature (operation)
Ambient temperature (storage/transport)
Standards/regulations

60 V DC
1 A (per path)
2 A (per byte)
-20°C ... 50°C
-20°C ... 70°C
IEC 60664 / DIN EN 50178

Technical data

Ordering data

Description
Digital IN or OUT 24 V DC from S5-115 through converters, system cables and front adapters to S7-300
IN 6ES5 420-7LA11 on 6ES7 321-1BL00-0AA0 6ES5 430-7LA11 on 6ES7 321-1BL00-0AA0
OUT 6ES5 441-7LA11 on 6ES7 322-1BL00-0AA0 6ES5 451-7LA11 on 6ES7 322-1BL00-0AA0

Type	Order No.	Pcs./Pkt.
FLKM S115/S7/FLK50/PLC/SO137	2306294	1

**Commissioning adapters for
extending the existing S5-115
field wiring**

All signals of the existing S5-115 wiring 3 or 5 are extended with the help of the universal commissioning adapters. The open cable end can be connected to various controllers such as S7-400 or S7-300. Thus, the existing field wiring of S5-115 can communicate with the new controller for test purposes. Since the new control unit is temporarily arranged before the control cabinet, the original status of the system can be restored if required.

The S5-115 is replaced once the system operates without errors with the new controller.

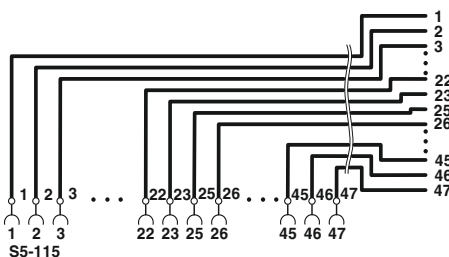

Startup adapter for
S5-115 field wiring

Maximum permissible operating voltage
Maximum permissible current
Ambient temperature (operation)
Ambient temperature (storage/transport)
Mounting position
Standards/regulations

250 V AC/DC
6 A (per path)
-20°C ... 50°C
-20°C ... 80°C
Any
DIN EN 50178 / IEC 60664

Technical data

Ordering data

Description
Connection of all S5-115 connections (1 to 23, 25 to 47) at the open cable end

Type	Order No.	Pcs./Pkt.
FLKM S115/47X0,75/3,0M/OE	2314985	1
FLKM S115/47X0,75/5,0M/OE	2314998	1

Retrofit and modernization components

Siemens SIMATIC® S7-300 Adapters for conversion from S5-95U to S7-300

S5-S7 adapters connect the S5-95U front adapters wired with individual wires to the I/O modules of the S7-300.

With the aid of the UM-S95U/S/FLK50/PLC converter module, the signals can be converted to a 50-pos. strip. A FLK 50/EZ-DR/.../KONFEK 50-pos. cable and the front adapter for SIMATIC® S7-300 (FLKM 50-PA-S300) establish a connection to the I/O module.

Notes:

Due to the geometry, it is not possible to couple any molded FLK connectors (e.g., VIP-PA...S7).

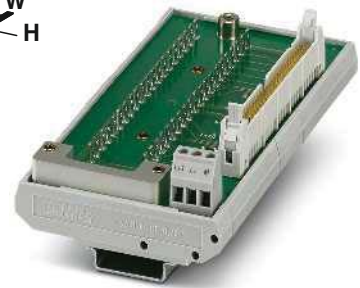

Converter for SIMATIC® S5-95U
to 50-pos. IDC/FLK pin strip

Technical data

Maximum permissible operating voltage	30 V DC
Maximum permissible current (per branch)	1 A
Ambient temperature (operation)	-20°C ... 50°C
Mounting position	Any
Standards/regulations	DIN EN 50178: 1998-04
Connection method	Field level Slip-on connection
Dimensions	Controller level IDC/FLK pin strip 77 mm / 49 mm

Ordering data

Description	No. of pos.	Module width W	Type	Order No.	Pcs./Pkt.
Digital 16 IN/16 OUT, 24 V DC from S5-95U/100U to S7-300					
S5-100U: 6ES5 482-8MA13 to 6ES7 323-1BL00-AA0					
S5-95U: 6ES5 095-8MA03 to 6ES7 323-1BL00-AA0					
		135 mm	UM-S95U/S7/FLK50/PLC	2907030	1



Allen Bradley PLC-5 (1771) Adapters for conversion from PLC-5 to S7-1500

Migration adapters connect the existing field wiring of an Allen Bradley PLC-5 (1771) controller. "1771-WG" or "1771-WH" front connectors can be connected.

There are three coupling options available:

- From Allen Bradley PLC-5 to SIMATIC® S7-1500
- From Allen Bradley PLC-5 to single wire (open cable end)
- From Allen Bradley PLC-5 to screw terminal block



new

Adaptation from Allen Bradley PLC-5 to SIMATIC® S7-1500



Technical data

Maximum permissible operating voltage	264 V AC/DC
Maximum permissible current	2 A (per path)
Ambient temperature (operation)	-20°C ... 60°C
Connection method	Plug connection
Standards/regulations	DIN EN 50178

Ordering data

Description	Module width W	Type	Order No.	Pcs./Pkt.
Migration adapter from Allen Bradley PLC-5 to SIMATIC® S7-1500				
1771-IAD to 6ES7 521-1FH00-0AA0		FLKM-1771-WH/S7-521-1FH/0,5M	2910089	1
1771-IND / 1771-IBD / 1771-ICD to 6ES7 521-1BH00-0AB0		FLKM-1771-WH/S7-521-1BH/0,5M	2910090	1
1771-IAD / 1771-IND / 1771-IBD / 1771-ICD to 6ES7 521-7EH00-0AB0		FLKM-1771-WH/S7-521-7EH/0,5M	2910092	1
1771-OBD / 1771-OBDS to 6ES7 522-5EH00-0AB0		FLKM-1771-WH/S7-522-5EH/0,5M	2910093	1
1771-OAD / 1771-OMD to 6ES7 522-5FH00-0AB0		FLKM-1771-WH/S7-522-5FH/0,5M	2910094	1
1771-OAD / 1771-OMD to 6ES7 522-5HH00-0AB0		FLKM-1771-WH/S7-522-5HH/0,5M	2910095	1
1771-OBD / 1771-OBDS to 6ES7 522-1BH00-0AB0		FLKM-1771-WH/S7-522-1BH/0,5M	2910096	1
1771-IFE to 6ES7 531-7NF10-0AB0 (current measurement)		FLKM-1771-WG/S7-531-7NF/I/0,5M	2910097	1
1771-IFF to 6ES7 531-7NF10-0AB0 (voltage measurement)		FLKM-1771-WG/S7-531-7NF/U/0,5M	2910098	1
Migration adapter from Allen Bradley PLC-5 to open cable end				
- For "1771 WH" front connectors				
- For "1771 WG" front connectors				
Migration adapter from Allen Bradley PLC-5 to screw connection terminal blocks (kit)				
- For "1771 WH" front connectors				
- For "1771 WG" front connectors				



new

Adaptation from Allen Bradley PLC-5 to single wire



new

Adaptation from Allen Bradley PLC-5 to screw connection terminal blocks



Technical data

264 V AC/DC
2 A (per path)
-20°C ... 60°C
Plug connection
DIN EN 50178

Ordering data

Type	Order No.	Pcs./Pkt.
FLKM-1771-WH/OE/21X0,5/0,7M	2910099	1
FLKM-1771-WG/OE/21X0,5/0,7M	2910100	1



Technical data

264 V AC/DC
2 A (per path)
-20°C ... 60°C
Plug connection
DIN EN 50178

Ordering data

Type	Order No.	Pcs./Pkt.
FLKM-1771-WH/SMKDS	2910102	1
FLKM-1771-WG/SMKDS	2910103	1

Universal modules

VIP – VARIOFACE Professional Modules with IDC/FLK pin strip

- 1:1 connection
- 10 to 64-pos.
- Screw connection
- Metal foot
- As per IEC 60603-13
- Low and high engagement latches are supplied with all modules.

Notes:

For marking systems (e.g., "ZB 22:UNBEDRUCKT"; Order No. 0811862) and mounting material, see Catalog 3.



10 to 20 positions
with screw connection



Technical data

Maximum permissible operating voltage	25 V AC / 60 V DC
Maximum permissible operating voltage UL / CSA	125 V / 125 V
Maximum permissible current (per branch)	1 A
Ambient temperature (operation)	-20°C ... 50°C
Mounting position	Any
Standards/regulations	IEC 60664, DIN EN 50178
Connection data solid/stranded/AWG	0.2 - 4 mm ² / 0.2 - 2.5 mm ² / 24 - 12
Dimensions	65.5 mm / 56 mm

Ordering data

Description	No. of pos.	Module width W	Type	Order No.	Pcs./Pkt.
VARIOFACE module, with pin strip	10	34.70	VIP-2/SC/FLK10	2315010	1
	14	39.80	VIP-2/SC/FLK14	2315023	1
	16	45.00	VIP-2/SC/FLK16	2315036	1
	20	55.10	VIP-2/SC/FLK20	2315049	1
VARIOFACE module, with pin strip	26	57.10			
	34	67.30			
	40	77.40			
	50	92.70			
	60	108.00			
	64	118.00			

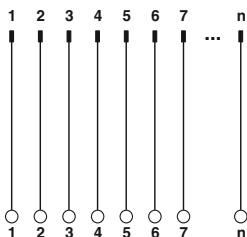



**26 to 64 positions
with screw connection**



Technical data

25 V AC / 60 V DC
125 V / 125 V

1 A
-20°C ... 50°C
Any
IEC 60664, DIN EN 50178
0.2 - 4 mm² / 0.2 - 2.5 mm² / 24 - 12
69 mm / 62 mm

Ordering data

Type	Order No.	Pcs./Pkt.
VIP-3/SC/FLK26	2315052	1
VIP-3/SC/FLK34	2315065	1
VIP-3/SC/FLK40	2315078	1
VIP-3/SC/FLK50	2315081	1
VIP-3/SC/FLK60	2315094	1
VIP-3/SC/FLK64	2315104	1

Universal modules

VIP – VARIOFACE Professional Modules with IDC/FLK pin strip

- 1:1 connection
- 10 to 64-pos.
- Push-in connection
- Metal foot
- As per IEC 60603-13
- Low and high engagement latches are supplied with all modules.

Notes:

For marking systems (e.g., "ZB 22:UNBEDRUCKT"; Order No. 0811862) and mounting material, see Catalog 3.



10 to 20 positions
with Push-in connection



Technical data

Maximum permissible operating voltage	25 V AC / 60 V DC
Maximum permissible operating voltage UL / CSA	125 V / 125 V
Maximum permissible current (per branch)	1 A
Ambient temperature (operation)	-20°C ... 50°C
Mounting position	Any
Standards/regulations	IEC 60664, DIN EN 50178
Connection data solid/stranded/AWG	0.14 - 2.5 mm ² / 0.14 - 2.5 mm ² / 26 - 14
Dimensions	72.1 mm / 56 mm

Ordering data

Description	No. of pos.	Module width W	Type	Order No.	Pcs./Pkt.
VARIOFACE module, with pin strip	10	36.80	VIP-2/PT/FLK10	2903787	1
	14	41.90	VIP-2/PT/FLK14	2903788	1
	16	46.90	VIP-2/PT/FLK16	2903789	1
	20	57.10	VIP-2/PT/FLK20	2903790	1
VARIOFACE module, with pin strip	26	57.10			
	34	67.30			
	40	77.40			
	50	92.70			
	60	107.90			
	64	118.10			

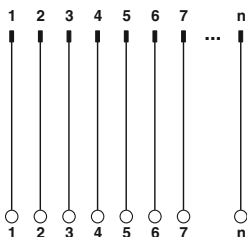

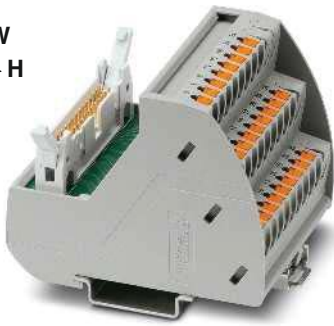

**26 to 64 positions
with Push-in connection**



Technical data

25 V AC / 60 V DC
125 V / 125 V

1 A
-20°C ... 50°C

Any

IEC 60664, DIN EN 50178

0.14 - 2.5 mm² / 0.14 - 2.5 mm² / 26 - 14

75.8 mm / 63 mm

Ordering data

Type	Order No.	Pcs./Pkt.
VIP-3/PT/FLK26	2903791	1
VIP-3/PT/FLK34	2903792	1
VIP-3/PT/FLK40	2903793	1
VIP-3/PT/FLK50	2903794	1
VIP-3/PT/FLK60	2903795	1
VIP-3/PT/FLK64	2903796	1

Universal modules

VIP – VARIOFACE Professional Modules with D-SUB connectors

- 1:1 connection
 - 9 to 50-pos.
 - Screw connection
 - Metal foot
 - As per IEC 60807-2
- The D-SUB-4-40 UNC threads are led on to a connecting terminal block directly.

Notes:

For marking systems (e.g., "ZB 22:UNBEDRUCKT"; Order No. 0811862) and mounting material, see Catalog 3.



9 to 15 positions
with screw connection



Technical data

Maximum permissible operating voltage	25 V AC / 60 V DC
Maximum permissible operating voltage UL / CSA	125 V / 105 V
Maximum permissible current (per branch)	2 A
Ambient temperature (operation)	-20°C ... 50°C
Mounting position	Any
Standards/regulations	IEC 60664, DIN EN 50178
Connection data solid/stranded/AWG	0.2 - 4 mm ² / 0.2 - 2.5 mm ² / 24 - 12
Dimensions	65.5 mm / 45.1 mm

Ordering data

Description	No. of pos.	Module width W	Type	Order No.	Pcs./Pkt.
VARIOFACE module , with D-Subminiature pin strip	9	34.70	VIP-2/SC/D 9SUB/M	2315117	1
	15	45.00	VIP-2/SC/D15SUB/M	2315120	1
VARIOFACE module , with D-Subminiature pin strip	25	57.40			
	37	72.70			
	50	98.20			
VARIOFACE module , with D-Subminiature socket	9	34.70	VIP-2/SC/D 9SUB/F	2315162	1
	15	45.00	VIP-2/SC/D15SUB/F	2315175	1
VARIOFACE module , with D-Subminiature socket	25	57.40			
	37	72.70			
	50	98.20			

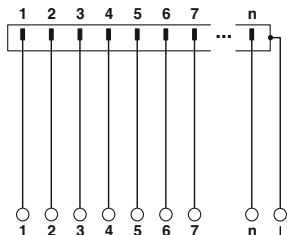



25 to 50 positions
with screw connection



Technical data

25 V AC / 60 V DC
125 V / 105 V

2 A
-20°C ... 50°C
Any

IEC 60664, DIN EN 50178
0.2 - 4 mm² / 0.2 - 2.5 mm² / 24 - 12
69 mm / 62 mm

Ordering data

Type	Order No.	Pcs./Pkt.
VIP-3/SC/D25SUB/M	2315133	1
VIP-3/SC/D37SUB/M	2315146	1
VIP-3/SC/D50SUB/M	2315159	1
VIP-3/SC/D25SUB/F	2315188	1
VIP-3/SC/D37SUB/F	2315191	1
VIP-3/SC/D50SUB/F	2315201	1

Universal modules

VIP – VARIOFACE Professional Modules with D-SUB connectors

- 1:1 connection
 - 9 to 50-pos.
 - Push-in connection
 - Metal foot
 - As per IEC 60807-2
- The D-SUB-4-40 UNC threads are led on to a connecting terminal block directly.

Notes:

For marking systems (e.g., "ZB 22:UNBEDRUCKT"; Order No. 0811862) and mounting material, see Catalog 3.



9 to 15 positions with Push-in connection



Technical data

Maximum permissible operating voltage	25 V AC / 60 V DC
Maximum permissible operating voltage UL / CSA	125 V / 105 V
Maximum permissible current (per branch)	2 A
Ambient temperature (operation)	-20°C ... 50°C
Mounting position	Any
Standards/regulations	IEC 60664, DIN EN 50178
Connection data solid/stranded/AWG	0.14 - 2.5 mm ² / 0.14 - 2.5 mm ² / 26 - 14
Dimensions	72.1 mm / 46.6 mm

Ordering data

Description	No. of pos.	Module width W	Type	Order No.	Pcs./Pkt.
VARIOFACE module , with D-Subminiature pin strip	9	36.80	VIP-2/PT/D 9SUB/M	2903777	1
	15	46.90	VIP-2/PT/D15SUB/M	2903779	1
VARIOFACE module , with D-Subminiature pin strip	25	57.10			
	37	72.30			
	50	97.70			
VARIOFACE module , with D-Subminiature socket	9	36.80	VIP-2/PT/D 9SUB/F	2903778	1
	15	46.90	VIP-2/PT/D15SUB/F	2903780	1
VARIOFACE module , with D-Subminiature socket	25	57.10			
	37	72.30			
	50	97.70			

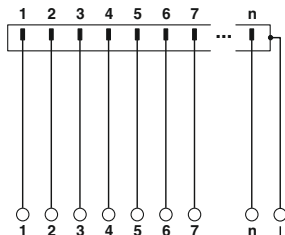



25 to 50 positions
with Push-in connection



Technical data

25 V AC / 60 V DC
125 V / 105 V

2 A
-20°C ... 50°C

Any
IEC 60664, DIN EN 50178
0.14 - 2.5 mm² / 0.14 - 2.5 mm² / 26 - 14
75.8 mm / 63 mm

Ordering data

Type	Order No.	Pcs./Pkt.
VIP-3/PT/D25SUB/M	2903781	1
VIP-3/PT/D37SUB/M	2903783	1
VIP-3/PT/D50SUB/M	2903785	1
VIP-3/PT/D25SUB/F	2903782	1
VIP-3/PT/D37SUB/F	2903784	1
VIP-3/PT/D50SUB/F	2903786	1

Universal modules

Feed-through modules for D-SUB connectors with screw connection

- 1:1 connection
- 9- to 50-pos.
- Screw connection
- As per IEC 60807-2
- D-SUB 4-40 UNC thread
- 9- to 37-pos.: Separate ground tap
- 50-pos.: No ground tap



With D-SUB pin strip



With D-SUB socket strip



Technical data

Maximum permissible operating voltage	25 V AC / 60 V DC
Maximum permissible operating voltage UL / CSA	125 V / -
Maximum permissible current (per branch)	2.5 A
Ambient temperature (operation)	-20°C ... 50°C
Mounting position	Any
Standards/regulations	IEC 60664, DIN EN 50178
Connection data solid/stranded/AWG	0.2 - 4 mm ² / 0.2 - 2.5 mm ² / 24 - 12

Ordering data

Description	No. of pos.	Module width W	Type	Order No.	Pcs./Pkt.
VARIOFACE feed-through module, with D-subminiature male connector	9	39.00	DFLK-D 9 SUB/S	2283870	5
	15	39.00	DFLK-D15 SUB/S	2280297	5
	25	39.00	DFLK-D25 SUB/S	2280310	5
	37	39.00	DFLK-D37 SUB/S	2280336	5
	50	39.00	DFLK-D50 SUB/S	2291286	5



Technical data

Maximum permissible operating voltage	25 V AC / 60 V DC
Maximum permissible operating voltage UL / CSA	125 V / -
Maximum permissible current (per branch)	2.5 A
Ambient temperature (operation)	-20°C ... 50°C
Mounting position	Any
Standards/regulations	IEC 60664, DIN EN 50178
Connection data solid/stranded/AWG	0.2 - 4 mm ² / 0.2 - 2.5 mm ² / 24 - 12

Ordering data

Description	No. of pos.	Module width W	Type	Order No.	Pcs./Pkt.
VARIOFACE feed-through module, with D-subminiature female connector	9	39.00	DFLK-D 9 SUB/B	2287135	5
	15	39.00	DFLK-D15 SUB/B	2280307	5
	25	39.00	DFLK-D25 SUB/B	2280323	5
	37	39.00	DFLK-D37 SUB/B	2280349	5
	50	39.00	DFLK-D50 SUB/B	2287669	5

Dimensioning of the housing cutout

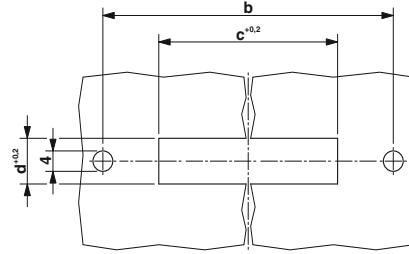

Dimensional drawing DFLK-D...SUB

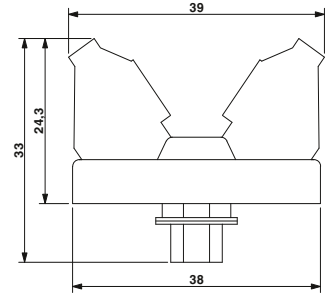

Type	a	b	c	d
With pin strip				
DFLK-D 9 SUB/S	58.4	52.5	40.2+0.2	13+0.2
DFLK-D 15 SUB/S	58.4	52.5	40.2+0.2	13+0.2
DFLK-D 25 SUB/S	83.4	77.5	54.2+0.2	13+0.2
DFLK-D 37 SUB/S	128.4	122.5	70.6+0.2	13+0.2
DFLK-D 50 SUB/S	143.4	137.5	67.8+0.2	15.8+0.2
With socket strip				
DFLK-D 9 SUB/B	58.4	52.5	40.2+0.2	13+0.2
DFLK-D 15 SUB/B	58.4	52.5	40.2+0.2	13+0.2
DFLK-D 25 SUB/B	83.4	77.5	54.2+0.2	13+0.2
DFLK-D 37 SUB/B	128.4	122.5	70.6+0.2	13+0.2
DFLK-D 50 SUB/B	143.4	137.5	67.8+0.2	15.8+0.2

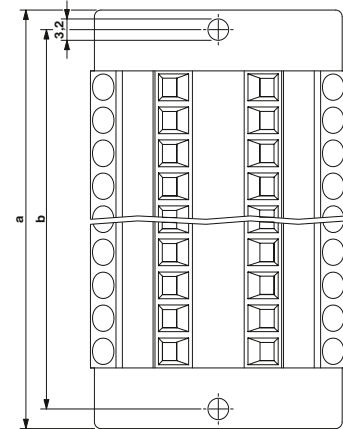

Universal modules

VIP – VARIOFACE Professional Modules for high density D-SUB connectors

- 1:1 connection
- 15- to 62-pos.
- Screw and Push-in connection
- Metal foot

The D-SUB-4-40 UNC threads are led directly to a connection terminal block.

Notes:
For marking systems (e.g., "ZB 22:UNBEDRUCKT"; Order No, 0811862) and mounting material, see Catalog 3.
1) Module with double-level terminal blocks



15- to 62-pos.
with screw connection

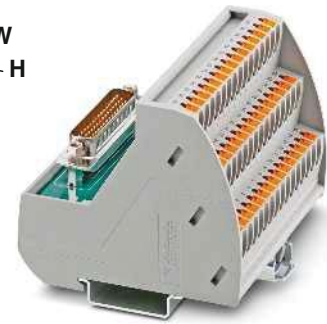

15- to 62-pos.
with Push-in connection



Maximum permissible operating voltage
Maximum permissible operating voltage UL / CSA

Maximum permissible current (per branch)
Ambient temperature (operation)
Mounting position
Standards/regulations

Connection data solid/stranded/AWG
Dimensions H / D

Technical data
25 V AC / 60 V DC
125 V / -
1 A
-20°C ... 50°C
Any
EN 50178
0.2 - 4 mm² / 0.2 - 2.5 mm² / 24 - 12
69 mm / 62 mm

Technical data
25 V AC / 60 V DC
125 V / 105 V
1 A
-20°C ... 50°C
Any
EN 50178
0.14 - 2.5 mm² / 0.14 - 2.5 mm² / 26 - 14
75.8 mm / 63 mm

H / D

Description	No. of pos.	Module width W
VARIOFACE module, with D-Subminiature pin strip		
with screw connection	26	52.30
with screw connection	44	82.90
with screw connection	62	113.50
with Push-in connection	26	52.00
with Push-in connection	44	82.50
with Push-in connection	62	113.00
VARIOFACE module, with D-Subminiature socket		
with screw connection ¹⁾	15	44.90
with screw connection	26	52.30
with screw connection	44	82.90
with screw connection	62	113.50
With Push-in connection ¹⁾	15	46.90
with Push-in connection	26	52.00
with Push-in connection	44	82.50
with Push-in connection	62	113.00

Ordering data		
Type	Order No.	Pcs./Pkt.
VIP-3/SC/HD26SUB/M	2322375	1
VIP-3/SC/HD44SUB/M	2322388	1
VIP-3/SC/HD62SUB/M	2322391	1
VIP-2/SC/HD15SUB/F	2322401	1
VIP-3/SC/HD26SUB/F	2322414	1
VIP-3/SC/HD44SUB/F	2322427	1
VIP-3/SC/HD62SUB/F	2322430	1

Ordering data		
Type	Order No.	Pcs./Pkt.
VIP-3/PT/HD26SUB/M	2904269	1
VIP-3/PT/HD44SUB/M	2904270	1
VIP-3/PT/HD62SUB/M	2904271	1
VIP-2/PT/HD15SUB/F	2904272	1
VIP-3/PT/HD26SUB/F	2904273	1
VIP-3/PT/HD44SUB/F	2904274	1
VIP-3/PT/HD62SUB/F	2904275	1

Modules with RJ45 connector

- 1:1 connection
- 8-positions, RJ45 connector
- Screw or Push-in connection (direct plug-in technology)
- Connector housing led to separate connection terminal blocks

Notes:
 For marking systems (e.g., "ZB 22:UNBEDRUCKT"; Order No, 0811862) and mounting material, see Catalog 3.



8-pos.
with screw connection



8-pos.
with Push-in connection

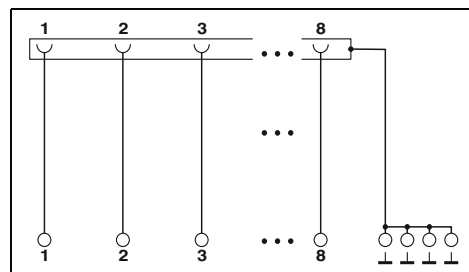

Technical data

Maximum permissible operating voltage	48 V AC/DC
Maximum permissible current (per branch)	1 A
Ambient temperature (operation)	-20°C ... 50°C
Mounting position	Any
Standards/regulations	DIN EN 50178
Connection data solid/stranded/AWG	0.2 - 4 mm ² / 0.2 - 2.5 mm ² / 24 - 12
Dimensions	69 mm / 62 mm

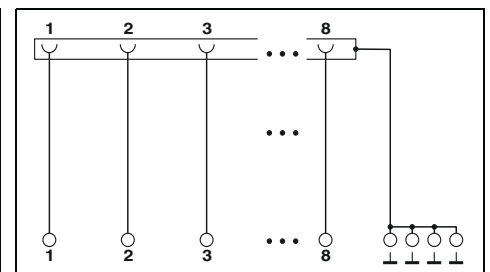

Technical data

Maximum permissible operating voltage	48 V AC/DC
Maximum permissible current (per branch)	1 A
Ambient temperature (operation)	-20°C ... 50°C
Mounting position	Any
Standards/regulations	EN 50178
Connection data solid/stranded/AWG	0.14 - 2.5 mm ² / 0.14 - 2.5 mm ² / 26 - 14
Dimensions	75.8 mm / 63 mm

Ordering data

Description	No. of pos.	Module width W
VARIOFACE module, with RJ45 connector with screw connection	8	26.90
with Push-in connection	8	26.60

Type	Order No.	Pcs./Pkt.
VIP-3/SC/RJ45	2900701	1

Ordering data

Type	Order No.	Pcs./Pkt.
VIP-3/PT/RJ45	2904290	1

Universal modules

Modules for ELCO connectors

These modules can be used to connect ELCO connectors of the 8016 series to screw connection terminal blocks.

Thanks to the slanted placement of the ELCO connector, the cables which are fed out of the side of the cable housing are led away without affecting the neighboring modules.

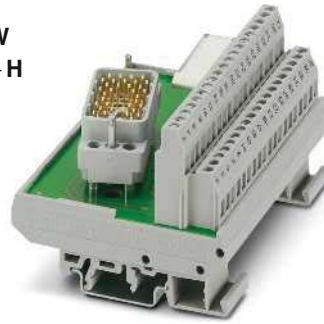

38-pos.

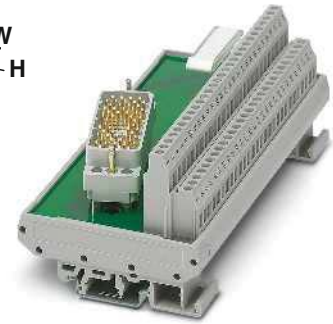

56-pos.

ERC

Technical data

Maximum permissible operating voltage	25 V AC / 60 V DC
Maximum permissible current (per branch)	2 A
Total current	76 A
Ambient temperature (operation)	-20°C ... 40°C
Mounting position	Any
Standards/regulations	IEC 60664, DIN EN 50178
Connection data solid/stranded/AWG	0.2 - 4 mm ² / 0.2 - 2.5 mm ² / 24 - 12
Dimensions	77 mm / 58.5 mm

H / D

Ordering data

Description	No. of pos.	Module width W
VARIOFACE module, with:		
- Pin strip 8016 right	38	101.50
- Pin strip 8016 left	38	101.50
VARIOFACE module, with:		
- Pin strip 8016 right	56	157.50
- Pin strip 8016 left	56	157.50

Type	Order No.	Pcs./Pkt.
UMK- EC38/38-XOR	2976297	1
UMK- EC38/38-XOL	2976284	1

ERC

Technical data

Maximum permissible operating voltage	125 V AC/DC
Maximum permissible current (per branch)	1.5 A
Total current	28 A (56 branches with 0.5 A each)
Ambient temperature (operation)	-20°C ... 50°C
Mounting position	Any
Standards/regulations	IEC 60664, DIN EN 50178
Connection data solid/stranded/AWG	0.2 - 4 mm ² / 0.2 - 2.5 mm ² / 24 - 12
Dimensions	77 mm / 58.5 mm

Ordering data

Type	Order No.	Pcs./Pkt.
UMK- EC56/56-XOR	2975900	1
UMK- EC56/56-XOL	2975890	1

Modules for ELCO connectors

Dimensional drawing for UMK-EC38/38-XOL

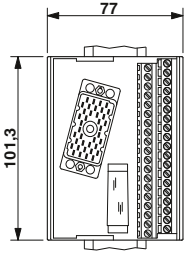

Dimensional drawing for UMK-EC38/38-XOR

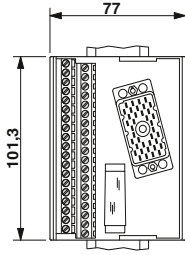

Dimensional drawing for UMK-EC56/56-XOL

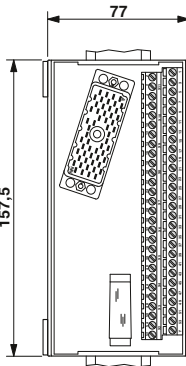

Dimensional drawing for UMK-EC56/56-XOR

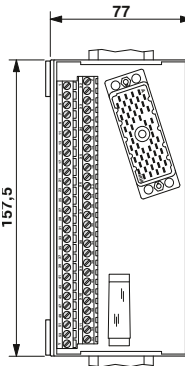

Pin assignment UMK-EC38/38...

Terminal block	Pin strip
1	A
2	B
3	C
4	D
5	E
6	F
7	H
8	J
9	K
10	L
11	M
12	N
13	P
14	R
15	S
16	T
17	U
18	V
19	W
20	X
21	Y
22	Z
23	AA
24	BB
25	DD
26	EE
27	FF
28	HH
29	JJ
30	KK
31	LL
32	MM
33	NN
34	PP
35	RR
36	SS
37	TT
CC	CC

Pin assignment UMK-EC56/56...

Terminal block	Pin strip
Z	Z
1	A
2	B
3	C
4	D
5	E
6	F
7	H
8	J
9	K
10	L
11	M
12	N
13	P
14	R
15	S
16	T
17	U
18	V
19	W
20	X
21	a
22	b
23	c
24	d
25	e
26	f
27	h
28	j
29	k
30	l
31	m
32	n
33	p
34	r
35	s
36	t
37	u
38	v
39	w
40	x
41	y
42	z
43	AA
44	BB
45	CC
46	DD
47	EE
48	FF
49	HH
50	JJ
51	KK
52	LL
53	MM
54	NN
Y	Y (shield)

Universal cables

System cables with IDC/FLK socket strip and an open end

- 1:1 connection
- 10-, 14-, and 16-pos.
- IDC/FLK connector in accordance with IEC 60603-13
- Open end at the other end

The individual wires at the open end are labeled (1, 2, 3, 4, ...) and equipped with a ferrule.



Not shielded



Technical data

Maximum permissible operating voltage	25 V AC / 60 V DC
Maximum permissible operating voltage UL / CSA	125 V / -
Maximum permissible current carrying capacity per path	1 A
Maximum conductor resistance	0.16 Ω/m
Ambient temperature (operation)	-20°C ... 50°C
Assembly	Insulation displacement, IEC 60352-4/DIN EN 60352-4
Conductor cross section	AWG 26 / 0.14 mm ²
Conductor structure: stranded wires / material	7 / Cu tin-plated
Outside diameter	
	10 -position 6.1 mm
	14 -position 6.4 mm
	16 -position 6.5 mm

Ordering data

Description	No. of pos.	Cable length	Type	Order No.	Pcs./Pkt.
Round cable with an open end					
	10	0.5 m	CABLE-FLK10/OE/0,14/ 0,5M	2904073	1
	10	1 m	CABLE-FLK10/OE/0,14/ 1,0M	2904074	1
	10	1.5 m	CABLE-FLK10/OE/0,14/ 1,5M	2904075	1
	10	2 m	CABLE-FLK10/OE/0,14/ 2,0M	2904076	1
	10	2.5 m	CABLE-FLK10/OE/0,14/ 2,5M	2904077	1
	10	3 m	CABLE-FLK10/OE/0,14/ 3,0M	2904078	1
	10	4 m	CABLE-FLK10/OE/0,14/ 4,0M	2904079	1
	10	6 m	CABLE-FLK10/OE/0,14/ 6,0M	2904080	1
	10	8 m	CABLE-FLK10/OE/0,14/ 8,0M	2904081	1
	10	10 m	CABLE-FLK10/OE/0,14/10,0M	2904082	1
Round cable, same as before, however in variable lengths	10		CABLE-FLK10-OE/0,14/...	2904331	1
Round cable with an open end					
	14	0.5 m	CABLE-FLK14/OE/0,14/ 50	2305761	1
	14	1 m	CABLE-FLK14/OE/0,14/ 100	2305253	1
	14	1.5 m	CABLE-FLK14/OE/0,14/ 150	2305266	1
	14	2 m	CABLE-FLK14/OE/0,14/ 200	2305279	1
	14	2.5 m	CABLE-FLK14/OE/0,14/ 250	2305282	1
	14	3 m	CABLE-FLK14/OE/0,14/ 300	2305295	1
	14	4 m	CABLE-FLK14/OE/0,14/ 400	2305774	1
	14	6 m	CABLE-FLK14/OE/0,14/ 600	2305787	1
	14	8 m	CABLE-FLK14/OE/0,14/ 800	2305790	1
	14	10 m	CABLE-FLK14/OE/0,14/1000	2305800	1
Round cable, same as before, however in variable lengths	14		CABLE-FLK14/OE/0,14/...	2305732	1
	16	0.5 m	CABLE-FLK16/OE/0,14/ 0,5M	2318127	1
	16	1 m	CABLE-FLK16/OE/0,14/ 1,0M	2318130	1
	16	1.5 m	CABLE-FLK16/OE/0,14/ 1,5M	2318143	1
	16	2 m	CABLE-FLK16/OE/0,14/ 2,0M	2318156	1
	16	2.5 m	CABLE-FLK16/OE/0,14/ 2,5M	2318169	1
	16	3 m	CABLE-FLK16/OE/0,14/ 3,0M	2318172	1
	16	4 m	CABLE-FLK16/OE/0,14/ 4,0M	2318185	1
	16	6 m	CABLE-FLK16/OE/0,14/ 6,0M	2318198	1
	16	8 m	CABLE-FLK16/OE/0,14/ 8,0M	2318208	1
	16	10 m	CABLE-FLK16/OE/0,14/10,0M	2318211	1
Round cable, same as before, however in variable lengths	16		CABLE-FLK16/OE/0,14/...	2318224	1

System cables with IDC/FLK socket strip and an open end

- 1:1 connection
 - 20- and 50-pos.
 - IDC/FLK connector in accordance with IEC 60603-13
 - Open end at the other end
- The individual wires at the open end are labeled (1, 2, 3, 4, ...) and equipped with a ferrule.



Not shielded



Technical data

Maximum permissible operating voltage	25 V AC / 60 V DC
Maximum permissible operating voltage UL / CSA	125 V / -
Maximum permissible current carrying capacity per path	1 A
Maximum conductor resistance	0.16 Ω/m
Ambient temperature (operation)	-20°C ... 50°C
Assembly	Insulation displacement, IEC 60352-4/DIN EN 60352-4
Conductor cross section	AWG 26 / 0.14 mm ²
Conductor structure: stranded wires / material	7 / Cu tin-plated
Outside diameter	
	20 -position 7.6 mm
	50 -position 10.3 mm

Ordering data

Description	No. of pos.	Cable length	Type	Order No.	Pcs./Pkt.
Round cable with an open end					
	20	0.5 m	CABLE-FLK20/OE/0,14/ 50	2305826	1
	20	1 m	CABLE-FLK20/OE/0,14/ 100	2305305	1
	20	1.5 m	CABLE-FLK20/OE/0,14/ 150	2305318	1
	20	2 m	CABLE-FLK20/OE/0,14/ 200	2305321	1
	20	2.5 m	CABLE-FLK20/OE/0,14/ 250	2305334	1
	20	3 m	CABLE-FLK20/OE/0,14/ 300	2305347	1
	20	4 m	CABLE-FLK20/OE/0,14/ 400	2305839	1
	20	6 m	CABLE-FLK20/OE/0,14/ 600	2305842	1
	20	8 m	CABLE-FLK20/OE/0,14/ 800	2305855	1
	20	10 m	CABLE-FLK20/OE/0,14/1000	2305868	1
Round cable, same as before, however in variable lengths	20		CABLE-FLK20/OE/0,14/...	2305745	1
Round cable with an open end					
	50	0.5 m	CABLE-FLK50/OE/0,14/ 50	2305871	1
	50	1 m	CABLE-FLK50/OE/0,14/ 100	2305350	1
	50	1.5 m	CABLE-FLK50/OE/0,14/ 150	2305363	1
	50	2 m	CABLE-FLK50/OE/0,14/ 200	2305376	1
	50	2.5 m	CABLE-FLK50/OE/0,14/ 250	2305389	1
	50	3 m	CABLE-FLK50/OE/0,14/ 300	2305392	1
	50	4 m	CABLE-FLK50/OE/0,14/ 400	2305884	1
	50	6 m	CABLE-FLK50/OE/0,14/ 600	2305897	1
	50	8 m	CABLE-FLK50/OE/0,14/ 800	2305907	1
	50	10 m	CABLE-FLK50/OE/0,14/1000	2305910	1
Round cable, same as before, however in variable lengths	50		CABLE-FLK50/OE/0,14/...	2305758	1

Universal cables

System cables with IDC/FLK socket strips

Standard lengths

Round cable sets are used to connect the PLC front adapters to the corresponding VARIOFACE controller boards.

The following versions are available with 14 and 50 positions:

- Not shielded
- Shielded
- Halogen-free

The cables are assembled on both ends with IDC/FLK socket strips in accordance with IEC 60603-13 (1:1 connection).

In case of shielded cables, a cable end with a ferrule is additionally provided as a shield connection (length: approx. 0.5 m; cable H05V-K 1 mm², black).

Special lengths are defined using an order key, refer to page 568.



Not shielded



Technical data

Maximum permissible operating voltage	25 V AC / 60 V DC
Maximum permissible operating voltage UL / CSA	125 V / -
Maximum permissible current carrying capacity per path	1 A
Maximum conductor resistance	0.16 Ω/m
Ambient temperature (operation)	-20°C ... 50°C
Shield	-
Assembly	Insulation displacement, IEC 60352-4/DIN EN 60352-4
Conductor cross section	AWG 26 / 0.14 mm ²
Conductor structure: stranded wires / material	7 / Cu tin-plated
Outside diameter	14 -position: 6.4 mm 50 -position: 10.3 mm

Ordering data

Description	No. of pos.	Cable length	Type	Order No.	Pcs./Pkt.
Assembled round cable¹⁾, with two 14-pos. IDC/FLK socket strips in fixed lengths, for transfer of 8 channels, for example					
	14	0.3 m	FLK 14/EZ-DR/ 30/KONFEK	2295729	5
	14	0.5 m	FLK 14/EZ-DR/ 50/KONFEK	2288901	5
	14	1 m	FLK 14/EZ-DR/ 100/KONFEK	2288914	1
	14	1.5 m	FLK 14/EZ-DR/ 150/KONFEK	2288927	1
	14	2 m	FLK 14/EZ-DR/ 200/KONFEK	2288930	1
	14	2.5 m	FLK 14/EZ-DR/ 250/KONFEK	2288943	1
	14	3 m	FLK 14/EZ-DR/ 300/KONFEK	2288956	1
	14	3.5 m	FLK 14/EZ-DR/ 350/KONFEK	2288969	1
	14	4 m	FLK 14/EZ-DR/ 400/KONFEK	2288972	1
	14	4.5 m	FLK 14/EZ-DR/ 450/KONFEK	2290847	1
	14	5 m	FLK 14/EZ-DR/ 500/KONFEK	2290834	1
	14	5.5 m	FLK 14/EZ-DR/ 550/KONFEK	2290850	1
	14	6 m	FLK 14/EZ-DR/ 600/KONFEK	2290863	1
	14	7 m			
	14	8 m	FLK 14/EZ-DR/ 800/KONFEK	2299563	1
	14	10 m	FLK 14/EZ-DR/1000/KONFEK	2299576	1
Assembled round cable²⁾, with two 50-pos. IDC/FLK socket strips in fixed lengths, for transfer of 32 channels, for example					
	50	0.5 m	FLK 50/EZ-DR/ 50/KONFEK	2289065	5
	50	1 m	FLK 50/EZ-DR/ 100/KONFEK	2289078	1
	50	1.5 m	FLK 50/EZ-DR/ 150/KONFEK	2289081	1
	50	2 m	FLK 50/EZ-DR/ 200/KONFEK	2289094	1
	50	2.5 m	FLK 50/EZ-DR/ 250/KONFEK	2289104	1
	50	3 m	FLK 50/EZ-DR/ 300/KONFEK	2289117	1
	50	3.5 m	FLK 50/EZ-DR/ 350/KONFEK	2289120	1
	50	4 m	FLK 50/EZ-DR/ 400/KONFEK	2289133	1
	50	4.5 m	FLK 50/EZ-DR/ 450/KONFEK	2289573	1
	50	5 m	FLK 50/EZ-DR/ 500/KONFEK	2289586	1
	50	5.5 m	FLK 50/EZ-DR/ 550/KONFEK	2289599	1
	50	6 m	FLK 50/EZ-DR/ 600/KONFEK	2289609	1
	50	6.5 m	FLK 50/EZ-DR/ 650/KONFEK	2289612	1
	50	7 m	FLK 50/EZ-DR/ 700/KONFEK	2289625	1
	50	7.5 m	FLK 50/EZ-DR/ 750/KONFEK	2289638	1
	50	8 m	FLK 50/EZ-DR/ 800/KONFEK	2289641	1
	50	8.5 m	FLK 50/EZ-DR/ 850/KONFEK	2289654	1
	50	9 m	FLK 50/EZ-DR/ 900/KONFEK	2289667	1
	50	9.5 m	FLK 50/EZ-DR/ 950/KONFEK	2289670	1
	50	10 m	FLK 50/EZ-DR/1000/KONFEK	2289683	1



Shielded with shield connection on one end



Technical data

25 V AC / 60 V DC
125 V / -

1 A

0.16 Ω/m
-20°C ... 50°C
Tinned copper-braided shield, approx. 85% covering

Insulation displacement, IEC 60352-4/DIN EN 60352-4

AWG 26 / 0.14 mm²
7 / Cu tin-plated

6.7 mm
11 mm

Ordering data

Type	Order No.	Pcs./Pkt.
FLK 14/EZ-DR/ 50/KONFEK/S	2296977	1
FLK 14/EZ-DR/ 100/KONFEK/S	2296980	1
FLK 14/EZ-DR/ 150/KONFEK/S	2296993	1
FLK 14/EZ-DR/ 200/KONFEK/S	2297002	1
FLK 14/EZ-DR/ 300/KONFEK/S	2299013	1
FLK 14/EZ-DR/ 400/KONFEK/S	2299026	1
FLK 14/EZ-DR/ 600/KONFEK/S	2299039	1
FLK 14/EZ-DR/ 800/KONFEK/S	2299042	1
FLK 14/EZ-DR/1000/KONFEK/S	2299055	1
FLK 50/EZ-DR/ 50/KONFEK/S	2299097	1
FLK 50/EZ-DR/ 100/KONFEK/S	2299107	1
FLK 50/EZ-DR/ 150/KONFEK/S	2299110	1
FLK 50/EZ-DR/ 200/KONFEK/S	2299123	1
FLK 50/EZ-DR/ 300/KONFEK/S	2299136	1
FLK 50/EZ-DR/ 400/KONFEK/S	2299149	1
FLK 50/EZ-DR/ 600/KONFEK/S	2299152	1
FLK 50/EZ-DR/ 800/KONFEK/S	2299165	1
FLK 50/EZ-DR/1000/KONFEK/S	2299178	1



Halogen-free (only the cable)



Technical data

25 V AC / 60 V DC
125 V / -

1 A

0.16 Ω/m
-20°C ... 50°C

Insulation displacement, IEC 60352-4/DIN EN 60352-4

AWG 26 / 0.14 mm²
7 / Cu tin-plated

6.4 mm
10.3 mm

Ordering data

Type	Order No.	Pcs./Pkt.
FLK 14/EZ-DR/HF/ 50/KONFEK	2305952	1
FLK 14/EZ-DR/HF/ 100/KONFEK	2305965	1
FLK 14/EZ-DR/HF/ 150/KONFEK	2305978	1
FLK 14/EZ-DR/HF/ 200/KONFEK	2305981	1
FLK 14/EZ-DR/HF/ 250/KONFEK	2305994	1
FLK 14/EZ-DR/HF/ 300/KONFEK	2304759	1
FLK 14/EZ-DR/HF/ 400/KONFEK	2304762	1
FLK 14/EZ-DR/HF/ 500/KONFEK	2304717	1
FLK 14/EZ-DR/HF/ 600/KONFEK	2306003	1
FLK 14/EZ-DR/HF/ 700/KONFEK	2314011	1
FLK 14/EZ-DR/HF/ 800/KONFEK	2314024	1
FLK 14/EZ-DR/HF/1000/KONFEK	2314037	1
CABLE-FLK50/0,14/HF/ 0,5M	2314134	1
CABLE-FLK50/0,14/HF/ 1,0M	2314147	1
CABLE-FLK50/0,14/HF/ 1,5M	2314150	1
CABLE-FLK50/0,14/HF/ 2,0M	2314163	1
CABLE-FLK50/0,14/HF/ 2,5M	2314176	1
CABLE-FLK50/0,14/HF/ 3,0M	2314189	1
CABLE-FLK50/0,14/HF/ 4,0M	2314192	1
CABLE-FLK50/0,14/HF/ 5,0M	2314202	1
CABLE-FLK50/0,14/HF/ 6,0M	2314215	1
CABLE-FLK50/0,14/HF/ 7,0M	2314228	1
CABLE-FLK50/0,14/HF/ 8,0M	2314231	1
CABLE-FLK50/0,14/HF/10,0M	2314244	1

Color code of system cables

Wire No.	Pin	Wire color
	1	Black
	2	Brown
	3	Red
	4	Orange
	5	Yellow
	6	Green
	7	Blue
	8	Violet
	9	Gray
10-pos.	10	White
	11	White-black
	12	White-brown
	13	White-red
14-pos.	14	White-orange
	15	White-yellow
16-pos.	16	White-green
	17	White-blue
	18	White-violet
	19	White-gray
20-pos.	20	Brown-black
	21	Brown-red
	22	Brown-orange
	23	Brown-yellow
	24	Brown-green
	25	Brown-blue
26-pos.	26	Brown-violet
	27	Brown-gray
	28	Brown-white
	29	Green-black
	30	Green-brown
	31	Green-red
	32	Green-orange
	33	Green-blue
34-pos.	34	Green-violet
	35	Green-gray
	36	Green-white
	37	Yellow-black
	38	Yellow-brown
	39	Yellow-red
40-pos.	40	Yellow-orange
	41	Yellow-blue
	42	Yellow-violet
	43	Yellow-gray
	44	Yellow-white
	45	Gray-black
	46	Gray-brown
	47	Gray-red
	48	Gray-orange
	49	Gray-yellow
50-pos.	50	Gray-green

1) IDC/FLK socket strip assembled straight at both ends.

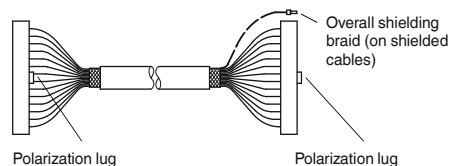

2) IDC/FLK socket strip assembled straight at one end and angled at the other.

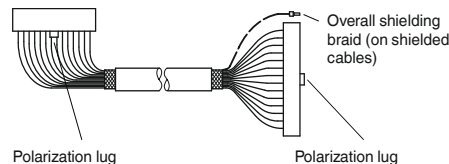

Universal cables

System cables with IDC/FLK socket strips

Standard lengths

Pre-assembled round cables to couple the VARIOFACE interface modules.

The cables are assembled on both ends with IDC/FLK socket strips in accordance with IEC 60603-13 (1:1 connection).

Special lengths are defined using an order key, refer to page 568.



Not shielded



Technical data

Maximum permissible operating voltage	25 V AC / 60 V DC
Maximum permissible operating voltage UL / CSA	125 V / -
Maximum permissible current carrying capacity per path	1 A
Maximum conductor resistance	0.16 Ω/m
Ambient temperature (operation)	-20°C ... 50°C
Assembly	Insulation displacement, IEC 60352-4/DIN EN 60352-4
Conductor cross section	AWG 26 / 0.14 mm ²
Conductor structure: stranded wires / material	7 / Cu tin-plated
Outside diameter	
	10 -position 6 mm
	16 -position 6.5 mm
	20 -position 7.6 mm

Ordering data

Description	No. of pos.	Cable length	Type	Order No.	Pcs./Pkt.
Round cable¹⁾, with two IDC/FLK socket strips					
	10	0.5 m	FLK 10/EZ-DR/ 50/KONFEK	2299204	1
	10	1 m	FLK 10/EZ-DR/ 100/KONFEK	2299217	1
	10	1.5 m	FLK 10/EZ-DR/ 150/KONFEK	2299220	1
	10	2 m	FLK 10/EZ-DR/ 200/KONFEK	2299233	1
	10	3 m	FLK 10/EZ-DR/ 300/KONFEK	2299246	1
	10	4 m	FLK 10/EZ-DR/ 400/KONFEK	2299259	1
	10	6 m	FLK 10/EZ-DR/ 600/KONFEK	2299262	1
	10	8 m	FLK 10/EZ-DR/ 800/KONFEK	2299275	1
	10	10 m	FLK 10/EZ-DR/1000/KONFEK	2299288	1
Round cable¹⁾, with two IDC/FLK socket strips					
	16	0.5 m	FLK 16/EZ-DR/ 50/KONFEK	2299291	1
	16	1 m	FLK 16/EZ-DR/ 100/KONFEK	2299301	1
	16	1.5 m	FLK 16/EZ-DR/ 150/KONFEK	2299314	1
	16	2 m	FLK 16/EZ-DR/ 200/KONFEK	2299327	1
	16	3 m	FLK 16/EZ-DR/ 300/KONFEK	2299330	1
	16	4 m	FLK 16/EZ-DR/ 400/KONFEK	2299343	1
	16	6 m	FLK 16/EZ-DR/ 600/KONFEK	2299356	1
	16	8 m	FLK 16/EZ-DR/ 800/KONFEK	2299369	1
	16	10 m	FLK 16/EZ-DR/1000/KONFEK	2299372	1
Round cable¹⁾, with two IDC/FLK socket strips					
	20	0.5 m	FLK 20/EZ-DR/ 50KONFEK	2296391	1
	20	1 m	FLK 20/EZ-DR/ 100KONFEK	2296401	1
	20	1.5 m	FLK 20/EZ-DR/ 150KONFEK	2296472	1
	20	2 m	FLK 20/EZ-DR/ 200KONFEK	2296485	1
	20	3 m	FLK 20/EZ-DR/ 300KONFEK	2296498	1
	20	4 m	FLK 20/EZ-DR/ 400KONFEK	2296508	1
	20	6 m	FLK 20/EZ-DR/ 600KONFEK	2296511	1
	20	8 m	FLK 20/EZ-DR/ 800KONFEK	2296524	1
	20	10 m	FLK 20/EZ-DR/1000KONFEK	2296537	1

¹⁾ IDC/FLK socket strip assembled straight at both ends.

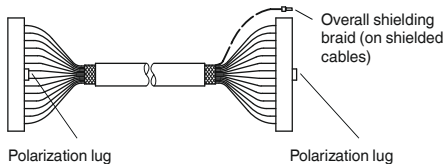

System cables with IDC/FLK socket strips

Standard lengths

Pre-assembled round cables to couple the VARIOFACE interface modules.

The cables are assembled on both ends with IDC/FLK socket strips in accordance with IEC 60603-13 (1:1 connection).

Special lengths are defined using an order key, refer to page 568.



Not shielded



Technical data

Maximum permissible operating voltage	25 V AC / 60 V DC
Maximum permissible operating voltage UL / CSA	125 V / -
Maximum permissible current carrying capacity per path	1 A
Maximum conductor resistance	0.16 Ω/m
Ambient temperature (operation)	-20°C ... 50°C
Assembly	Insulation displacement, IEC 60352-4/DIN EN 60352-4
Conductor cross section	AWG 26 / 0.14 mm ²
Conductor structure: stranded wires / material	7 / Cu tin-plated
Outside diameter	
	26 -position 7.8 mm
	34 -position 8.7 mm
	40 -position 9.9 mm

Ordering data

Description	No. of pos.	Cable length	Type	Order No.	Pcs./Pkt.
Round cable¹⁾, with two IDC/FLK socket strips					
	26	0.5 m	FLK 26/EZ-DR/ 50/KONFEK	2299385	1
	26	1 m	FLK 26/EZ-DR/ 100/KONFEK	2299398	1
	26	1.5 m	FLK 26/EZ-DR/ 150/KONFEK	2299408	1
	26	2 m	FLK 26/EZ-DR/ 200/KONFEK	2299411	1
	26	3 m	FLK 26/EZ-DR/ 300/KONFEK	2299424	1
	26	4 m	FLK 26/EZ-DR/ 400/KONFEK	2299437	1
	26	6 m	FLK 26/EZ-DR/ 600/KONFEK	2299440	1
	26	8 m	FLK 26/EZ-DR/ 800/KONFEK	2299453	1
	26	10 m	FLK 26/EZ-DR/1000/KONFEK	2299466	1
Round cable¹⁾, with two IDC/FLK socket strips					
	34	0.5 m	FLK 34/EZ-DR/ 50/KONFEK	2299479	1
	34	1 m	FLK 34/EZ-DR/ 100/KONFEK	2299482	1
	34	1.5 m	FLK 34/EZ-DR/ 150/KONFEK	2299495	1
	34	2 m	FLK 34/EZ-DR/ 200/KONFEK	2299505	1
	34	3 m	FLK 34/EZ-DR/ 300/KONFEK	2299518	1
	34	4 m	FLK 34/EZ-DR/ 400/KONFEK	2299521	1
	34	6 m	FLK 34/EZ-DR/ 600/KONFEK	2299534	1
	34	8 m	FLK 34/EZ-DR/ 800/KONFEK	2299547	1
	34	10 m	FLK 34/EZ-DR/1000/KONFEK	2299550	1
Round cable²⁾, with two IDC/FLK socket strips					
	40	0.5 m	FLK 40/EZ-DR/ 50/KONFEK	2288985	5
	40	1 m	FLK 40/EZ-DR/ 100/KONFEK	2288998	1
	40	1.5 m	FLK 40/EZ-DR/ 150/KONFEK	2289007	1
	40	2 m	FLK 40/EZ-DR/ 200/KONFEK	2289010	1
	40	2.5 m	FLK 40/EZ-DR/ 250/KONFEK	2289023	1
	40	3 m	FLK 40/EZ-DR/ 300/KONFEK	2289036	1
	40	3.5 m	FLK 40/EZ-DR/ 350/KONFEK	2289049	1
	40	4 m	FLK 40/EZ-DR/ 400/KONFEK	2289052	1
	40	6 m	FLK 40/EZ-DR/ 600/KONFEK	2299589	1
	40	8 m	FLK 40/EZ-DR/ 800/KONFEK	2299592	1
	40	10 m	FLK 40/EZ-DR/1000/KONFEK	2299602	1

²⁾ IDC/FLK socket strip assembled straight at one end and angled at the other.

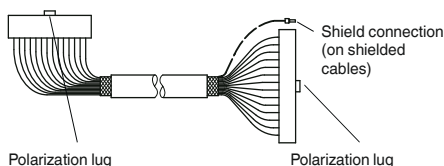

Universal cables

System cables with IDC/FLK socket strip

Special lengths

Pre-assembled round cables for connecting, e.g., PLC front adapters to the corresponding VARIOFACE termination boards. The cables are assembled with IDC/FLK socket strips on both ends in accordance with IEC 60603-13. For shielded cables, a cable end with ferrule is also available as a shield connection (length: approx. 0.5 m; cable: H05V-K 1 mm², black).

The order key for special lengths is described using three features.

The order of the features is as follows:

- Cable type
- Assembly
- Length in meters

There are two order keys, one for unshielded round cables, FLK EZ-DR/.../.../...,

and one for shielded round cables, FLK EZ-DR-S/.../.../.... To ensure clear specification when ordering, the features are described in detail below:

Cable type

- This specifies the number of individual cables of the specific cable.

Assembly

- None, the cable is not assembled at either end,
- 10-pos. IDC/FLK socket strip at both ends, the cable is assembled at both ends with 10-pos. IDC/FLK socket strips (1:1 connection),
- 14-pos. IDC/FLK socket strip at both ends, the cable is assembled at both ends with 14-pos. IDC/FLK socket strips (1:1 connection), etc. to

- 50-pos. IDC/FLK socket strip at both ends, the cable is assembled at both ends with 50-pos. IDC/FLK socket strips (1:1 connection),
- 14-pos. IDC/FLK socket strip at one end, 16-pos. IDC/FLK socket strip at one end, the cable is assembled with a 14-pos. IDC/FLK socket strip at one end and a 16-pos. IDC/FLK socket strip at one end (for SIMATIC® S7, no 1:1 connection).

Features of permissible configurations:

Cable type	Unshielded round cables FLK EZ-DR.../.../....					Shielded round cables FLK EZ-DR-S.../.../....						
	10-pos.	14-pos.	16-pos.	20-pos.	26-pos.	34-pos.	40-pos.	50-pos.	14-pos.	16-pos.	40-pos.	50-pos.
No assembly	10U/C00/...	14U/C00/...	16U/C00/...	20U/C00/...	26U/C00/...	34U/C00/...	40U/C00/...	50U/C00/...	14S/C00/...	16S/C00/...	40S/C00/...	50S/C00/...
10-pos. IDC/FLK at both ends	10U/C55/... ¹⁾											
14-pos. IDC/FLK at both ends		14U/C23/... ¹⁾							14S/C23/... ¹⁾			
16-pos. IDC/FLK at both ends			16U/C58/... ¹⁾							16S/C58/... ¹⁾		
20-pos. IDC/FLK at both ends				20U/C61/... ¹⁾								
26-pos. IDC/FLK at both ends					26U/C63/... ¹⁾							
34-pos. IDC/FLK at both ends						34U/C65/... ¹⁾						
40-pos. IDC/FLK at both ends							40U/C30/... ³⁾				40S/C30/... ³⁾	
50-pos. IDC/FLK at both ends								50U/C38/... ³⁾				50S/C38/... ³⁾
14-pos. IDC/FLK at one end, 16-pos. IDC/FLK at one end		14U/C52/... ¹⁾							14S/C52/... ¹⁾			

¹⁾ IDC/FLK socket strip assembled straight at both ends.

²⁾ IDC/FLK socket strip assembled straight at one end and angled at the other.

³⁾ IDC/FLK socket strip assembled straight at one end and angled at the other.

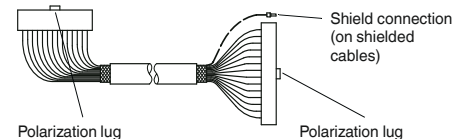
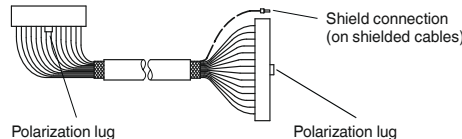
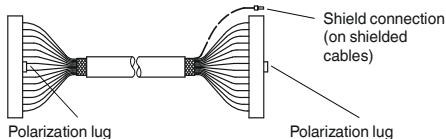

Ordering example for unshielded round cable:

- unshielded 50-pos. round cable, assembled with two 50-pos. IDC/FLK socket strips, 11.5 m long

Quantity	Order No.	Cable type	Assembly	Length [m] ⁴⁾
1	2295059	50U 10U ≙ 10-pos. unshielded 14U ≙ 14-pos. unshielded 16U ≙ 16-pos. unshielded 20U ≙ 20-pos. unshielded 26U ≙ 26-pos. unshielded 34U ≙ 34-pos. unshielded 40U ≙ 40-pos. unshielded 50U ≙ 50-pos. unshielded	C38 C00 ≙ No assembly C55 ≙ 10-pos. IDC/FLK socket strip at both ends C23 ≙ 14-pos. IDC/FLK socket strip at both ends C52 ≙ 14-pos. IDC/FLK socket strip at one end, 16-pos. IDC/FLK socket strip at one end (for S7) C58 ≙ 16-pos. IDC/FLK socket strip at both ends C61 ≙ 20-pos. IDC/FLK socket strip at both ends C63 ≙ 26-pos. IDC/FLK socket strip at both ends C65 ≙ 34-pos. IDC/FLK socket strip at both ends C30 ≙ 40-pos. IDC/FLK socket strip at both ends C38 ≙ 50-pos. IDC/FLK socket strip at both ends	11.50 ⁴⁾ min. 0.20 m

Ordering example for shielded round cable:

- shielded 14-pos. round cable, assembled with two 14-pos. IDC/FLK socket strips, 12.75 m long

Quantity	Order No.	Cable type	Assembly	Length [m] ⁴⁾
1	2295046	14S 14S ≙ 14-pos. shielded 16S ≙ 16-pos. shielded 40S ≙ 40-pos. shielded 50S ≙ 50-pos. shielded	C23 C00 ≙ No assembly C23 ≙ 14-pos. IDC/FLK socket strip at both ends C52 ≙ 14-pos. IDC/FLK socket strip at one end, 16-pos. IDC/FLK socket strip at one end (for S7) C58 ≙ 16-pos. IDC/FLK socket strip at both ends C30 ≙ 40-pos. IDC/FLK socket strip at both ends C38 ≙ 50-pos. IDC/FLK socket strip at both ends	12.75 ⁴⁾ min. 0.20 m



Not shielded



Shielded



Technical data

Maximum permissible operating voltage
 Maximum permissible operating voltage UL / CSA
 Maximum permissible current carrying capacity per path
 Maximum conductor resistance
 Ambient temperature (operation)
 Shield

25 V AC / 60 V DC
 125 V / -
 1 A
 0.16 Ω/m
 -20°C ... 50°C
 -

Conductor cross section
 Conductor structure: stranded wires / material

AWG 26 / 0.14 mm²
 7 / Cu tin-plated



Technical data

25 V AC / 60 V DC
 125 V / -
 1 A
 0.16 Ω/m
 -20°C ... 50°C
 Tinned copper-braided shield, approx. 85% covering

AWG 26 / 0.14 mm²
 7 / Cu tin-plated

Ordering data

Description	Cable length
Assembled round cables, with socket strips in variable lengths	

Type	Order No.	Pcs./Pkt.
FLK EZ-DR.../.../...	2295059	1

Ordering data

Type	Order No.	Pcs./Pkt.
FLK EZ-DR-S.../.../...	2295046	1

Universal cables

System cables with DSUB socket and pin strip

Standard lengths

- 1:1 connection
- Shielded round cables
- Connector in accordance with IEC 60807-2/DIN 41652
- Screw connection: 2 UNC 4-40 screws
- Assembly versions:
 - D-SUB socket strip on one side and D-SUB pin strip on the other
 - D-SUB sockets on both sides
 - DSUB pin strips on both sides

Special lengths are defined using an order key, refer to page 574.



Socket at one end and pin strip at the other



Technical data

Maximum permissible operating voltage	25 V AC / 60 V DC
Maximum permissible operating voltage UL / CSA	125 V / 125 V
Maximum permissible current carrying capacity per path	2 A
Maximum conductor resistance	0.09 Ω/m
Ambient temperature (operation)	-20°C ... 50°C
Shield	Tinned copper-braided shield, approx. 85% covering
Insertion/withdrawal cycles	>200
Conductor cross section	AWG 24 / 0.25 mm ²
Outside diameter	9 -position 7.5 mm 15 -position 9 mm 25 -position 10.5 mm 37 -position 12.5 mm 50 -position 13.5 mm

Ordering data

Description	No. of pos.	Cable length	Type	Order No.	Pcs./Pkt.
Shielded round cable, fitted with two D-SUB strips, various numbers of positions and lengths					
	9	0.5 m	CABLE-D 9SUB/B/S/ 50/KONFEK/S	2299987	1
	9	1 m	CABLE-D 9SUB/B/S/100/KONFEK/S	2299990	1
	9	1.5 m	CABLE-D 9SUB/B/S/150/KONFEK/S	2300009	1
	9	2 m	CABLE-D 9SUB/B/S/200/KONFEK/S	2302010	1
	9	3 m	CABLE-D 9SUB/B/S/300/KONFEK/S	2302023	1
	9	4 m	CABLE-D 9SUB/B/S/400/KONFEK/S	2302036	1
	9	6 m	CABLE-D 9SUB/B/S/600/KONFEK/S	2302049	1
	15	0.5 m	CABLE-D15SUB/B/S/ 50/KONFEK/S	2302052	1
	15	1 m	CABLE-D15SUB/B/S/100/KONFEK/S	2302065	1
	15	1.5 m	CABLE-D15SUB/B/S/150/KONFEK/S	2302078	1
	15	2 m	CABLE-D15SUB/B/S/200/KONFEK/S	2302081	1
	15	3 m	CABLE-D15SUB/B/S/300/KONFEK/S	2302094	1
	15	4 m	CABLE-D15SUB/B/S/400/KONFEK/S	2302104	1
	15	6 m	CABLE-D15SUB/B/S/600/KONFEK/S	2302117	1
	25	0.5 m	CABLE-D25SUB/B/S/ 50/KONFEK/S	2302120	1
	25	1 m	CABLE-D25SUB/B/S/100/KONFEK/S	2302133	1
	25	1.5 m	CABLE-D25SUB/B/S/150/KONFEK/S	2302146	1
	25	2 m	CABLE-D25SUB/B/S/200/KONFEK/S	2302159	1
	25	3 m	CABLE-D25SUB/B/S/300/KONFEK/S	2302162	1
	25	4 m	CABLE-D25SUB/B/S/400/KONFEK/S	2302175	1
	25	6 m	CABLE-D25SUB/B/S/600/KONFEK/S	2302188	1
	37	0.5 m	CABLE-D37SUB/B/S/ 50/KONFEK/S	2302191	1
	37	1 m	CABLE-D37SUB/B/S/100/KONFEK/S	2302201	1
	37	2 m	CABLE-D37SUB/B/S/200/KONFEK/S	2302227	1
	37	3 m	CABLE-D37SUB/B/S/300/KONFEK/S	2302230	1
	37	4 m	CABLE-D37SUB/B/S/400/KONFEK/S	2302243	1
	37	6 m	CABLE-D37SUB/B/S/600/KONFEK/S	2302256	1
	37	8 m			
	37	10 m			
	37	15 m			
	37	20 m			
	50	0.5 m	CABLE-D50SUB/B/S/ 50/KONFEK/S	2302269	1
	50	1 m	CABLE-D50SUB/B/S/100/KONFEK/S	2302272	1
	50	1.5 m	CABLE-D50SUB/B/S/150/KONFEK/S	2302285	1
	50	2 m	CABLE-D50SUB/B/S/200/KONFEK/S	2302298	1
	50	3 m	CABLE-D50SUB/B/S/300/KONFEK/S	2302308	1
	50	4 m	CABLE-D50SUB/B/S/400/KONFEK/S	2302311	1
	50	6 m	CABLE-D50SUB/B/S/600/KONFEK/S	2302324	1



Socket strip at both ends



Male connector at both ends



Technical data

25 V AC / 60 V DC
 125 V / 125 V
 2 A
 0.09 Ω/m
 -20°C ... 50°C
 Tinned copper-braided shield, approx. 85% covering
 >200
 AWG 24 / 0.25 mm²
 7.5 mm
 9 mm
 10.5 mm
 12 mm
 13.5 mm

Technical data

25 V AC / 60 V DC
 125 V / 125 V
 2 A
 0.09 Ω/m
 -20°C ... 50°C
 Tinned copper-braided shield, approx. 85% covering
 >200
 AWG 24 / 0.25 mm²
 7.5 mm
 9 mm
 10.5 mm
 12 mm
 13.5 mm

Ordering data

Ordering data

Type	Order No.	Pcs./Pkt.
CABLE-D 9SUB/B/B/100/KONFEK/S	2305415	1
CABLE-D 9SUB/B/B/200/KONFEK/S	2305428	1
CABLE-D 9SUB/B/B/300/KONFEK/S	2305431	1
CABLE-D15SUB/B/B/100/KONFEK/S	2305444	1
CABLE-D15SUB/B/B/200/KONFEK/S	2305457	1
CABLE-D15SUB/B/B/300/KONFEK/S	2305460	1
CABLE-D25SUB/B/B/100/KONFEK/S	2305473	1
CABLE-D25SUB/B/B/200/KONFEK/S	2305486	1
CABLE-D25SUB/B/B/300/KONFEK/S	2305499	1
CABLE-D37SUB/B/B/ 100/KONFEK/S	2305509	1
CABLE-D37SUB/B/B/ 200/KONFEK/S	2305512	1
CABLE-D37SUB/B/B/ 300/KONFEK/S	2305525	1
CABLE-D37SUB/B/B/ 400/KONFEK/S	2900759	1
CABLE-D37SUB/B/B/ 600/KONFEK/S	2900760	1
CABLE-D37SUB/B/B/ 800/KONFEK/S	2900761	1
CABLE-D37SUB/B/B/1000/KONFEK/S	2900762	1
CABLE-D37SUB/B/B/1500/KONFEK/S	2900763	1
CABLE-D37SUB/B/B/2000/KONFEK/S	2900764	1
CABLE-D50SUB/B/B/100/KONFEK/S	2305541	1
CABLE-D50SUB/B/B/200/KONFEK/S	2305554	1
CABLE-D50SUB/B/B/300/KONFEK/S	2305567	1

Type	Order No.	Pcs./Pkt.
CABLE-D 9SUB/S/S/100/KONFEK/S	2305570	1
CABLE-D 9SUB/S/S/200/KONFEK/S	2305583	1
CABLE-D 9SUB/S/S/300/KONFEK/S	2305596	1
CABLE-D15SUB/S/S/100/KONFEK/S	2305606	1
CABLE-D15SUB/S/S/200/KONFEK/S	2305619	1
CABLE-D15SUB/S/S/300/KONFEK/S	2305622	1
CABLE-D25SUB/S/S/100/KONFEK/S	2305635	1
CABLE-D25SUB/S/S/200/KONFEK/S	2305648	1
CABLE-D25SUB/S/S/300/KONFEK/S	2305651	1
CABLE-D37SUB/S/S/100/KONFEK/S	2305664	1
CABLE-D37SUB/S/S/200/KONFEK/S	2305677	1
CABLE-D37SUB/S/S/300/KONFEK/S	2305680	1
CABLE-D50SUB/S/S/100/KONFEK/S	2305693	1
CABLE-D50SUB/S/S/200/KONFEK/S	2305703	1
CABLE-D50SUB/S/S/300/KONFEK/S	2305716	1

Universal cables

System cables with DSUB socket and pin strip

Standard lengths

- 1:1 connection
- Halogen-free shielded round cables
- Screw connection: 2 UNC 4-40 screws
- Connector in accordance with IEC 60807-2/DIN 41652

Assembly versions:

- D-SUB socket strip on one side and D-SUB pin strip on the other
- D-SUB sockets on both sides
- DSUB pin strips on both sides

Special lengths are configured using separate order numbers.

Ordering example:

One halogen-free system cable assembled with two 37-pos. D-SUB socket strips in a length of 14.50 m:

1 pc. 1075563/14.50

Notes:

¹⁾Maximum permissible current carrying capacity per path for 37- and 50-pos. cables: 1.5 A

new



Socket strip at one end and pin strip at the other
Halogen-free



Technical data

Maximum permissible operating voltage	25 V AC / 60 V DC
Maximum permissible operating voltage UL / CSA	125 V / 125 V
Maximum permissible current carrying capacity per path	2 A ¹⁾
Maximum conductor resistance	0.09 Ω/m
Ambient temperature (operation)	-20°C ... 50°C
Shield	Tinned copper braided shield
Insertion/withdrawal cycles	>200
Conductor cross section	AWG 24 / 0.25 mm ²
Outside diameter	
	9 -position 7.1 mm
	15 -position 8.3 mm
	25 -position 10.2 mm
	37 -position 11.2 mm
	50 -position 13.2 mm

Ordering data

Description	No. of pos.	Cable length	Type	Order No.	Pcs./Pkt.
Shielded halogen-free round cable, fitted with two D-SUB strips					
	9	1 m	CABLE-D 9SUB/B/S/HF/S/ 1,0M	1066591	1
	9	2 m	CABLE-D 9SUB/B/S/HF/S/ 2,0M	1066592	1
	9	3 m	CABLE-D 9SUB/B/S/HF/S/ 3,0M	1066593	1
Round cable, same as before, however in variable lengths					
	9		CABLE-D 9SUB-B-S-HF-S/...	1075568	1
Shielded halogen-free round cable, fitted with two D-SUB strips					
	15	1 m	CABLE-D15SUB/B/S/HF/S/ 1,0M	1066600	1
	15	2 m	CABLE-D15SUB/B/S/HF/S/ 2,0M	1066602	1
	15	3 m	CABLE-D15SUB/B/S/HF/S/ 3,0M	1066603	1
Round cable, same as before, however in variable lengths					
	15		CABLE-D15SUB-B-S-HF-S/...	1075565	1
Shielded halogen-free round cable, fitted with two D-SUB strips					
	25	1 m	CABLE-D25SUB/B/S/HF/S/ 1,0M	1066665	1
	25	2 m	CABLE-D25SUB/B/S/HF/S/ 2,0M	1066666	1
	25	3 m	CABLE-D25SUB/B/S/HF/S/ 3,0M	1066667	1
Round cable, same as before, however in variable lengths					
	25		CABLE-D25SUB-B-S-HF-S/...	1075559	1
Shielded halogen-free round cable, fitted with two D-SUB strips					
	37	1 m	CABLE-D37SUB/B/S/HF/S/ 1,0M	1066608	1
	37	2 m	CABLE-D37SUB/B/S/HF/S/ 2,0M	1066609	1
	37	3 m	CABLE-D37SUB/B/S/HF/S/ 3,0M	1066611	1
Round cable, same as before, however in variable lengths					
	37		CABLE-D37SUB-B-S-HF-S/...	1075562	1
Shielded halogen-free round cable, fitted with two D-SUB strips					
	50	1 m	CABLE-D50SUB/B/S/HF/S/ 1,0M	1066678	1
	50	2 m	CABLE-D50SUB/B/S/HF/S/ 2,0M	1066679	1
	50	3 m	CABLE-D50SUB/B/S/HF/S/ 3,0M	1066681	1
Round cable, same as before, however in variable lengths					
	50		CABLE-D50SUB-B-S-HF-S/...	1075554	1

new



Socket strip at both ends
Halogen-free

new



Pin strip at both ends
Halogen-free



Technical data

25 V AC / 60 V DC
125 V / 125 V

2 A

0.09 Ω/m
-20°C ... 50°C
Tinned copper braided shield
>200
AWG 24 / 0.25 mm²

7.1 mm
8.3 mm
10.2 mm
11.2 mm
13.2 mm



Technical data

25 V AC / 60 V DC
125 V / 125 V

2 A

0.09 Ω/m
-20°C ... 50°C
Tinned copper braided shield
>200
AWG 24 / 0.25 mm²

7.1 mm
8.3 mm
10.2 mm
11.2 mm
13.2 mm

Ordering data

Ordering data

Type	Order No.	Pcs./Pkt.
CABLE-D 9SUB/B/B/HF/S/ 1,0M	1066587	1
CABLE-D 9SUB/B/B/HF/S/ 2,0M	1066588	1
CABLE-D 9SUB/B/B/HF/S/ 3,0M	1066589	1
CABLE-D 9SUB-B-B-HF-S/...	1075569	1
CABLE-D15SUB/B/B/HF/S/ 1,0M	1066597	1
CABLE-D15SUB/B/B/HF/S/ 2,0M	1066598	1
CABLE-D15SUB/B/B/HF/S/ 3,0M	1066599	1
CABLE-D15SUB-B-B-HF-S/...	1075566	1
CABLE-D25SUB/B/B/HF/S/ 1,0M	1066657	1
CABLE-D25SUB/B/B/HF/S/ 2,0M	1066660	1
CABLE-D25SUB/B/B/HF/S/ 3,0M	1066664	1
CABLE-D25SUB-B-B-HF-S/...	1075560	1
CABLE-D37SUB/B/B/HF/S/ 1,0M	2908516	1
CABLE-D37SUB/B/B/HF/S/ 2,0M	2908517	1
CABLE-D37SUB/B/B/HF/S/ 3,0M	2908518	1
CABLE-D37SUB-B-B-HF-S/...	1075563	1
CABLE-D50SUB/B/B/HF/S/ 1,0M	1066672	1
CABLE-D50SUB/B/B/HF/S/ 2,0M	1066673	1
CABLE-D50SUB/B/B/HF/S/ 3,0M	1066674	1
CABLE-D50SUB-B-B-HF-S/...	1075557	1

Type	Order No.	Pcs./Pkt.
CABLE-D 9SUB/S/S/HF/S/ 1,0M	1066594	1
CABLE-D 9SUB/S/S/HF/S/ 2,0M	1066595	1
CABLE-D 9SUB/S/S/HF/S/ 3,0M	1066596	1
CABLE-D 9SUB-S-S-HF-S/...	1075567	1
CABLE-D15SUB/S/S/HF/S/ 1,0M	1066604	1
CABLE-D15SUB/S/S/HF/S/ 2,0M	1066606	1
CABLE-D15SUB/S/S/HF/S/ 3,0M	1066607	1
CABLE-D15SUB-S-S-HF-S/...	1075564	1
CABLE-D25SUB/S/S/HF/S/ 1,0M	1066668	1
CABLE-D25SUB/S/S/HF/S/ 2,0M	1066669	1
CABLE-D25SUB/S/S/HF/S/ 3,0M	1066671	1
CABLE-D25SUB-S-S-HF-S/...	1075558	1
CABLE-D37SUB/S/S/HF/S/ 1,0M	1066612	1
CABLE-D37SUB/S/S/HF/S/ 2,0M	1066614	1
CABLE-D37SUB/S/S/HF/S/ 3,0M	1066615	1
CABLE-D37SUB-S-S-HF-S/...	1075561	1
CABLE-D50SUB/S/S/HF/S/ 1,0M	1066682	1
CABLE-D50SUB/S/S/HF/S/ 2,0M	1066683	1
CABLE-D50SUB/S/S/HF/S/ 3,0M	1066684	1
CABLE-D50SUB-S-S-HF-S/...	1075553	1

Universal cables

System cables with D-SUB socket and pin strips

Special lengths

Pre-assembled, shielded **round cables** for connecting VARIOFACE termination boards. The cables are assembled with D-SUB strips in accordance with IEC 60807-2/DIN 41652.

The order key is described using three features.

- The order of the features is as follows:
- Cable type
 - Assembly
 - Length in meters

There are three assembly versions for the shielded round cable:

- CABLE D-SUB-S/.../.../... D-SUB socket strip at one end and D-SUB pin strip at the other end,
- CABLE D-SUB-B-B-S/.../.../... D-SUB socket strips at both ends,

- CABLE D-SUB-S-S-S/.../.../... D-SUB pin strips at both ends
To ensure clear specification when ordering, the features are described in detail below:

- 50-pos. D-SUB socket strip at one end, 50-pos. D-SUB pin strip at the other end, the cable connects (1:1) a 50-pos. D-SUB socket and pin strip.

Cable type

- This specifies the number of individual cables of the specific cable.

Assembly

- (Example for CABLE D-SUB-S/.../.../...)
- None, the cable is not assembled at either end,
- 9-pos. D-SUB socket strip at one end, 9-pos. D-SUB pin strip at the other end, the cable connects (1:1) a 9-pos. D-SUB socket and pin strip,
- 15-pos. D-SUB socket strip at one end, 15-pos. D-SUB pin strip at the other end, the cable connects (1:1) a 15-pos. D-SUB socket and pin strip, etc. to

Ordering example for round cable assembled with pin strip at one end and socket strip at the other end

– shielded 25-pos. round cable, assembled with a 25-pos. D-SUB socket strip and a 25-pos. D-SUB pin strip, 11.5 mm long

Quantity	Order No.	Cable type	Assembly	Length [m] ¹⁾
1	2302340	25S 09S ≙ 9-pos. shielded 15S ≙ 15-pos. shielded 25S ≙ 25-pos. shielded 37S ≙ 37-pos. shielded 50S ≙ 50-pos. shielded	C36 C00 ≙ No assembly C01 ≙ 9-pos. D-SUB socket strip at one end 9-pos. D-SUB pin strip at one end C28 ≙ 15-pos. D-SUB socket strip at one end 15-pos. D-SUB pin strip at one end C36 ≙ 25-pos. D-SUB socket strip at one end 25-pos. D-SUB pin strip at one end C43 ≙ 37-pos. D-SUB socket strip at one end 37-pos. D-SUB pin strip at one end C49 ≙ 50-pos. D-SUB socket strip at one end 50-pos. D-SUB pin strip at one end	11.50 ¹⁾ min. 0.20 m

Ordering example for round cable assembled with socket strip at both ends

– shielded 37-pos. round cable, assembled with two D-SUB 37 socket strips, 12.75 m long

Quantity	Order No.	Cable type	Assembly	Length [m] ¹⁾
1	2302421	37S 09S ≙ 9-pos. shielded 15S ≙ 15-pos. shielded 25S ≙ 25-pos. shielded 37S ≙ 37-pos. shielded 50S ≙ 50-pos. shielded	C44 C00 ≙ No assembly C22 ≙ 9-pos. D-SUB socket strip at both ends C29 ≙ 15-pos. D-SUB socket strip at both ends C37 ≙ 25-pos. D-SUB socket strip at both ends C44 ≙ 37-pos. D-SUB socket strip at both ends C50 ≙ 50-pos. D-SUB socket strip at both ends	12.75 ¹⁾ min. 0.20 m

Ordering example for round cable assembled with pin strip at both ends

– shielded 15-pos. round cable, assembled with two D-SUB 15 pin strips, 8.5 m long

Quantity	Order No.	Cable type	Assembly	Length [m] ¹⁾
1	2302434	15S 09S ≙ 9-pos. shielded 15S ≙ 15-pos. shielded 25S ≙ 25-pos. shielded 37S ≙ 37-pos. shielded 50S ≙ 50-pos. shielded	C71 C00 ≙ No assembly C70 ≙ 9-pos. D-SUB pin strip at both ends C71 ≙ 15-pos. D-SUB pin strip at both ends C72 ≙ 25-pos. D-SUB pin strip at both ends C73 ≙ 37-pos. D-SUB pin strip at both ends C74 ≙ 50-pos. D-SUB pin strip at both ends	8.50 ¹⁾ min. 0.20 m



Shielded



Technical data

Maximum permissible operating voltage	25 V AC / 60 V DC
Maximum permissible operating voltage UL / CSA	125 V / 125 V
Maximum permissible current carrying capacity per path	2 A
Maximum conductor resistance	0.09 Ω/m
Ambient temperature (operation)	-20°C ... 50°C
Shield	Tinned copper-braided shield, approx. 85% covering
Insertion/withdrawal cycles	>200
Conductor cross section	AWG 24 / 0.25 mm ²

Ordering data

Description	Cable length	Type	Order No.	Pcs./Pkt.
Assembled round cables, in variable lengths, pin strip on one side and socket strip on one side		CABLE D-SUB-S/.../.../...	2302340	1
Assembled round cables, in variable lengths, socket strip on both sides		CABLE D-SUB-B-B-S/.../.../...	2302421	1
Assembled round cables, in variable lengths, pin strip on both sides		CABLE D-SUB-S-S-S/.../.../...	2302434	1

Universal cables

System cables with D-SUB female connector or pin strip and one open end

- 1:1 connection
- D-SUB female connector or pin strip at one end
- Connector in accordance with IEC 60807-2/DIN 41652
- Screw connection: 2 UNC 4-40 screws
- Open end at the other end
- Individual wire marking: 1, 2, 3, 4, etc.
- Individual wires fitted with ferrules
- Shield connection: H05V-K 1 mm² cable, black, 0.5 m in length



Female connector at one end and open end at the other end



Pin strip at one end and open end at the other end



Maximum permissible operating voltage
Maximum permissible operating voltage UL / CSA

25 V AC / 60 V DC
125 V / 125 V

25 V AC / 60 V DC
125 V / 125 V

Maximum permissible current carrying capacity per path

2 A

2 A

Maximum conductor resistance
Ambient temperature (operation)
Shield

0.09 Ω/m
-20°C ... 50°C
Tinned copper-braided shield, approx. 85% covering

0.09 Ω/m
-20°C ... 50°C
Tinned copper-braided shield, approx. 85% covering

Insertion/withdrawal cycles
Conductor cross section
Outside diameter

>200
AWG 24 / 0.25 mm²

>200
AWG 24 / 0.25 mm²

9 -position 7.5 mm
15 -position 9 mm
25 -position 10.5 mm

7.5 mm
9 mm
10.5 mm

Ordering data

Ordering data

Description	No. of pos.	Cable length	Ordering data			Ordering data		
			Type	Order No.	Pcs./Pkt.	Type	Order No.	Pcs./Pkt.
Round cable with an open end	9	0.5 m	CABLE-D- 9SUB/F/OE/0,25/S/0,5M	2926014	1	CABLE-D- 9SUB/M/OE/0,25/S/0,5M	2926360	1
	9	1 m	CABLE-D- 9SUB/F/OE/0,25/S/1,0M	2926027	1	CABLE-D- 9SUB/M/OE/0,25/S/1,0M	2926373	1
	9	1.5 m	CABLE-D- 9SUB/F/OE/0,25/S/1,5M	2926030	1	CABLE-D- 9SUB/M/OE/0,25/S/1,5M	2926386	1
	9	2 m	CABLE-D- 9SUB/F/OE/0,25/S/2,0M	2926043	1	CABLE-D- 9SUB/M/OE/0,25/S/2,0M	2926399	1
	9	3 m	CABLE-D- 9SUB/F/OE/0,25/S/3,0M	2926056	1	CABLE-D- 9SUB/M/OE/0,25/S/3,0M	2926409	1
	9	4 m	CABLE-D- 9SUB/F/OE/0,25/S/4,0M	2926069	1	CABLE-D- 9SUB/M/OE/0,25/S/4,0M	2926412	1
	9	6 m	CABLE-D- 9SUB/F/OE/0,25/S/6,0M	2926072	1	CABLE-D- 9SUB/M/OE/0,25/S/6,0M	2926425	1
Round cable , same as before, however in variable lengths	9		CABLE-D- 9SUB-F-OE-0,25-S/...	2900903	1	CABLE-D- 9SUB-M-OE-0,25-S/...	2900909	1
Round cable with an open end	15	0.5 m	CABLE-D-15SUB/F/OE/0,25/S/0,5M	2926085	1	CABLE-D-15SUB/M/OE/0,25/S/0,5M	2926438	1
	15	1 m	CABLE-D-15SUB/F/OE/0,25/S/1,0M	2926098	1	CABLE-D-15SUB/M/OE/0,25/S/1,0M	2926441	1
	15	1.5 m	CABLE-D-15SUB/F/OE/0,25/S/1,5M	2926108	1	CABLE-D-15SUB/M/OE/0,25/S/1,5M	2926454	1
	15	2 m	CABLE-D-15SUB/F/OE/0,25/S/2,0M	2926111	1	CABLE-D-15SUB/M/OE/0,25/S/2,0M	2926467	1
	15	3 m	CABLE-D-15SUB/F/OE/0,25/S/3,0M	2926124	1	CABLE-D-15SUB/M/OE/0,25/S/3,0M	2926470	1
	15	4 m	CABLE-D-15SUB/F/OE/0,25/S/4,0M	2926137	1	CABLE-D-15SUB/M/OE/0,25/S/4,0M	2926483	1
	15	6 m	CABLE-D-15SUB/F/OE/0,25/S/6,0M	2926140	1	CABLE-D-15SUB/M/OE/0,25/S/6,0M	2926496	1
Round cable , same as before, however in variable lengths	15		CABLE-D-15SUB-F-OE-0,25-S/...	2900905	1	CABLE-D-15SUB-M-OE-0,25-S/...	2900910	1
Round cable with an open end	25	0.5 m	CABLE-D-25SUB/F/OE/0,25/S/0,5M	2926153	1	CABLE-D-25SUB/M/OE/0,25/S/0,5M	2926506	1
	25	1 m	CABLE-D-25SUB/F/OE/0,25/S/1,0M	2926166	1	CABLE-D-25SUB/M/OE/0,25/S/1,0M	2926519	1
	25	1.5 m	CABLE-D-25SUB/F/OE/0,25/S/1,5M	2926179	1	CABLE-D-25SUB/M/OE/0,25/S/1,5M	2926522	1
	25	2 m	CABLE-D-25SUB/F/OE/0,25/S/2,0M	2926182	1	CABLE-D-25SUB/M/OE/0,25/S/2,0M	2926535	1
	25	3 m	CABLE-D-25SUB/F/OE/0,25/S/3,0M	2926195	1	CABLE-D-25SUB/M/OE/0,25/S/3,0M	2926548	1
	25	4 m	CABLE-D-25SUB/F/OE/0,25/S/4,0M	2926205	1	CABLE-D-25SUB/M/OE/0,25/S/4,0M	2926551	1
	25	6 m	CABLE-D-25SUB/F/OE/0,25/S/6,0M	2926218	1	CABLE-D-25SUB/M/OE/0,25/S/6,0M	2926564	1
Round cable , same as before, however in variable lengths	25		CABLE-D-25SUB-F-OE-0,25-S/...	2900906	1	CABLE-D-25SUB-M-OE-0,25-S/...	2900911	1

Special lengths of D-SUB cable with open ends are configured using separate order numbers.

Ordering example:

One system cable assembled with a 37-pos. D-SUB female connector and one open end, 12.75 m in length:

1 pcs. 2900907/12,75



Female connector at one end and open end at the other end



Pin strip at one end and open end at the other end



Technical data

Maximum permissible operating voltage	25 V AC / 60 V DC
Maximum permissible operating voltage UL / CSA	125 V / 125 V
Maximum permissible current carrying capacity per path	2 A
Maximum conductor resistance	0.09 Ω/m
Ambient temperature (operation)	-20°C ... 50°C
Shield	Tinned copper-braided shield, approx. 85% covering
Insertion/withdrawal cycles	>200
Conductor cross section	AWG 24 / 0.25 mm ²
Outside diameter	37 -position: 12 mm 50 -position: 13.5 mm



Technical data

Maximum permissible operating voltage	25 V AC / 60 V DC
Maximum permissible operating voltage UL / CSA	125 V / 125 V
Maximum permissible current carrying capacity per path	2 A
Maximum conductor resistance	0.09 Ω/m
Ambient temperature (operation)	-20°C ... 50°C
Shield	Tinned copper-braided shield, approx. 85% covering
Insertion/withdrawal cycles	>200
Conductor cross section	AWG 24 / 0.25 mm ²
Outside diameter	12 mm 13.5 mm

Ordering data

Description	No. of pos.	Cable length	Type	Order No.	Pcs./Pkt.
Round cable with an open end	37	0.5 m	CABLE-D-37SUB/F/OE/0,25/S/0,5M	2926221	1
	37	1 m	CABLE-D-37SUB/F/OE/0,25/S/1,0M	2926234	1
	37	1.5 m	CABLE-D-37SUB/F/OE/0,25/S/1,5M	2926247	1
	37	2 m	CABLE-D-37SUB/F/OE/0,25/S/2,0M	2926250	1
	37	3 m	CABLE-D-37SUB/F/OE/0,25/S/3,0M	2926263	1
	37	4 m	CABLE-D-37SUB/F/OE/0,25/S/4,0M	2926276	1
	37	6 m	CABLE-D-37SUB/F/OE/0,25/S/6,0M	2926289	1
Round cable, same as before, however in variable lengths	37		CABLE-D-37SUB-F-OE-0,25-S/...	2900907	1
Round cable with an open end	50	0.5 m	CABLE-D-50SUB/F/OE/0,25/S/0,5M	2926292	1
	50	1 m	CABLE-D-50SUB/F/OE/0,25/S/1,0M	2926302	1
	50	1.5 m	CABLE-D-50SUB/F/OE/0,25/S/1,5M	2926315	1
	50	2 m	CABLE-D-50SUB/F/OE/0,25/S/2,0M	2926328	1
	50	3 m	CABLE-D-50SUB/F/OE/0,25/S/3,0M	2926331	1
	50	4 m	CABLE-D-50SUB/F/OE/0,25/S/4,0M	2926344	1
	50	6 m	CABLE-D-50SUB/F/OE/0,25/S/6,0M	2926357	1
Round cable, same as before, however in variable lengths	50		CABLE-D-50SUB-F-OE-0,25-S/...	2900908	1

Ordering data

Description	No. of pos.	Cable length	Type	Order No.	Pcs./Pkt.
Round cable with an open end	37	0.5 m	CABLE-D-37SUB/M/OE/0,25/S/0,5M	2926577	1
	37	1 m	CABLE-D-37SUB/M/OE/0,25/S/1,0M	2926580	1
	37	1.5 m	CABLE-D-37SUB/M/OE/0,25/S/1,5M	2926593	1
	37	2 m	CABLE-D-37SUB/M/OE/0,25/S/2,0M	2926603	1
	37	3 m	CABLE-D-37SUB/M/OE/0,25/S/3,0M	2926616	1
	37	4 m	CABLE-D-37SUB/M/OE/0,25/S/4,0M	2926629	1
	37	6 m	CABLE-D-37SUB/M/OE/0,25/S/6,0M	2926632	1
Round cable, same as before, however in variable lengths	37		CABLE-D-37SUB-M-OE-0,25-S/...	2900912	1
Round cable with an open end	50	0.5 m	CABLE-D-50SUB/M/OE/0,25/S/0,5M	2926645	1
	50	1 m	CABLE-D-50SUB/M/OE/0,25/S/1,0M	2926658	1
	50	1.5 m	CABLE-D-50SUB/M/OE/0,25/S/1,5M	2926661	1
	50	2 m	CABLE-D-50SUB/M/OE/0,25/S/2,0M	2926674	1
	50	3 m	CABLE-D-50SUB/M/OE/0,25/S/3,0M	2926687	1
	50	4 m	CABLE-D-50SUB/M/OE/0,25/S/4,0M	2926690	1
	50	6 m	CABLE-D-50SUB/M/OE/0,25/S/6,0M	2926700	1
Round cable, same as before, however in variable lengths	50		CABLE-D-50SUB-M-OE-0,25-S/...	2900913	1

Potential distributors

Modules as compact potential distributors

The VIP-2/.../PDM... modules offer the following features:

- Two potential levels
- Separate supply
- Screw or Push-in connection
- Consecutive marking
- Optionally with fuse

Notes:
Marking systems and mounting material See Catalog 3
¹⁾ No UL approval



With screw connection and 2 potential levels

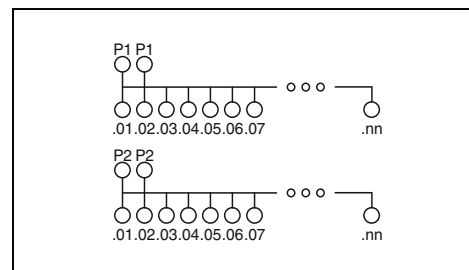

Technical data

Maximum permissible operating voltage	250 V AC/DC
Maximum permissible operating voltage UL / CSA	250 V / 250 V
Maximum permissible current (per branch)	15 A
Total current	30 A (per potential)
Ambient temperature (operation)	-20°C ... 50°C
Mounting position	Any
Standards/regulations	IEC 60664, DIN EN 50178
Supply connection data solid/stranded/AWG	0.2 - 6 mm ² / 0.2 - 4 mm ² / 24 - 10
Distribution connection data solid/stranded/AWG	0.2 - 4 mm ² / 0.2 - 2.5 mm ² / 24 - 12
Dimensions	H / D 65.5 mm / 50 mm

Ordering data

Description	No. of pos.	Module width W	Type	Order No.	Pcs./Pkt.
VARIOFACE module , with two busbars (P1, P2) for potential distribution, per potential:					
2 power terminal blocks/8 distributor terminal blocks		50.00	VIP-2/SC/PDM-2/16	2315256	1
2 power terminal blocks/12 distributor terminal blocks		70.40	VIP-2/SC/PDM-2/24	2315269	1
2 power terminal blocks/16 distributor terminal blocks		90.80	VIP-2/SC/PDM-2/32	2315272	1
2 power terminal blocks/24 distributor terminal blocks		131.50	VIP-2/SC/PDM-2/48¹⁾	2903717	1
VARIOFACE module , with two busbars (P1, P2) for potential distribution, per potential:					
2 power terminal blocks/8 distributor terminal blocks		41.90			
2 power terminal blocks/12 distributor terminal blocks		57.10			
2 power terminal blocks/16 distributor terminal blocks		67.30			
2 power terminal blocks/24 distributor terminal blocks		97.70			
VARIOFACE module with 2 busbars for potential distribution					
- 2 power terminal blocks/ 8 distributor blocks		97.70			



With Push-in connection and 2 potential levels



With Push-in connection and 2 potential levels and eight 6.3 A fuses

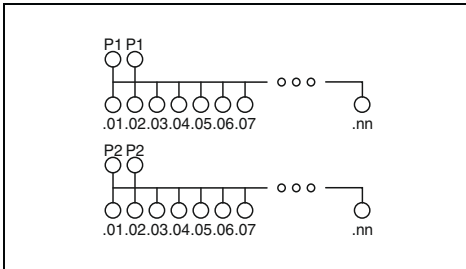

Technical data

250 V AC/DC
250 V / 250 V

15 A
30 A (per potential)
-20°C ... 50°C

Any
IEC 60664, DIN EN 50178
0.25 - 6 mm² / 0.25 - 4 mm² / 24 - 10

0.14 - 2.5 mm² / 0.14 - 2.5 mm² / 26 - 14

75.8 mm / 63 mm

Ordering data

Type	Order No.	Pcs./Pkt.
VIP-3/PT/PDM-2/16	2903797	1
VIP-3/PT/PDM-2/24	2903798	1
VIP-3/PT/PDM-2/32	2903799	1
VIP-3/PT/PDM-2/48	2903800	1

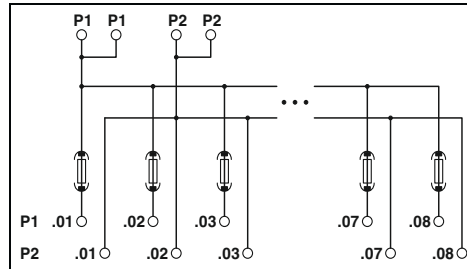

Technical data

250 V AC/DC
250 V / 250 V

6.3 A (fuse limited)
30 A (per potential)
-20°C ... 60°C

Any
IEC 60664, DIN EN 50178
0.2 - 10 mm² / 0.2 - 6 mm² / 24 - 8

0.14 - 2.5 mm² / 0.14 - 2.5 mm² / 26 - 14

109.8 mm / 51 mm

Ordering data

Type	Order No.	Pcs./Pkt.
VIP-2/PT/PDM-2/16/FU 6.3A	2903603	1

Quality in quantity

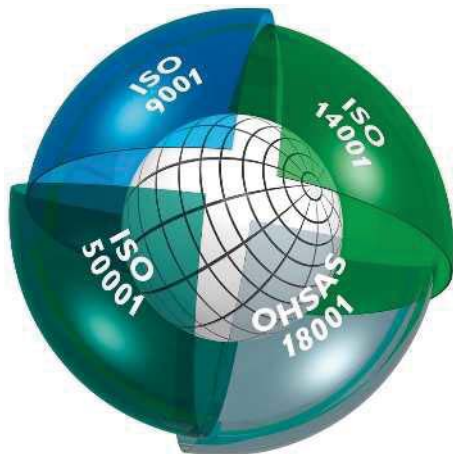

Integrated management system

The objective of the Phoenix Contact integrated management system is to integrate all requirements pertaining to products, processes, and the organization.

Statutory and regulatory requirements, as well as those of international standards and our customers, are met and, in some cases, even exceeded in all phases of the product lifecycle.

The Phoenix Contact management system is monitored by internationally recognized independent bodies each year to ensure that quality, environmental protection, energy efficiency, and occupational safety have been integrated in conformance with the relevant requirements. Certification in accordance with international standards ISO 9001, ISO 14001, ISO 50001, and BS OHSAS 18001 is the result of our corporate philosophy of meeting the needs of our customers, staff, and environment as best as possible. This serves as the basis for innovative products with the familiar high Phoenix Contact quality standard, actively practiced environmental protection through efficient production and products that conserve resources, and responsibility in the field of occupational health and safety. It goes without saying that we integrate all further requirements of standards, international approvals or special customer requirements into our company processes.

The result of this system is a building block for the success of the Phoenix Contact Group as well as its products and services.

CE marking

CE marking was introduced as an important instrument for the free movement of goods and services within the single European market. By applying the mark to a product, the manufacturer confirms its compliance with all EU directives applicable to this product. The EU directives describe the product characteristics with regard to device safety and the avoidance of risks. They have been incorporated in national legislation. Compliance with the requirements is a **condition for placing the product on the market within the EU.**

Where applicable, our products currently fall within the scope of the following directives in particular:

- 2014/35/EU
Electrical equipment designed for use within certain voltage limits (Low Voltage Directive)
- 2014/30/EU
Electromagnetic compatibility (EMC Directive)
- 2014/32/EU
Measuring instruments
- 2006/42/EC
Safety of machinery (Machinery Directive)
- 2014/34/EU
Equipment and protective systems intended for use in potentially explosive atmospheres (ATEX Directive)
- 2014/53/EU
Radio equipment (RED)
- 2011/65/EU
Restriction of the use of certain hazardous substances (RoHS Directive)
- 2012/19/EU
Waste electrical and electronic equipment (WEEE Directive)

The standards used as the basis for the aforementioned directives have been at the heart of our development standard for some time as a way of ensuring compliance with European directives. The numbers of the directives indicate their version at the time of publication. In the event of changes to directives and/or standards, our products will undergo conformity assessment again in good time and a new declaration of conformity will be issued promptly. The current declarations for each product can also be found in our download area.

Among the aforementioned European directives, the EMC Directive plays a particularly important role. It uses a directive enshrined in national legislation as the basis for defining electromagnetic compatibility as a fundamental device property. European legislation therefore places great emphasis on the electromagnetic compatibility of devices and systems as a basic prerequisite for the error-free operation of machines and systems. As an international leader in the field of surge protection, Phoenix Contact has extensive expertise in EMC. This expertise and the experience gained over many years in the development and application of industrial interface and communication technology have resulted in an extremely high standard of quality for our products when it comes to electromagnetic compatibility. Our independent laboratory, Phoenix Testlab, was founded in order to share this expertise with other companies. Phoenix Testlab GmbH is an accredited service company, which carries out EMC testing in compliance with European standards. At Phoenix Testlab, devices are also tested with regard to their electrical safety, mechanical influences, and their behavior in relation to environmental influences. Phoenix Testlab is

also a notified body in accordance with EMC Directive 2014/30/EU and Radio Equipment Directive (RED) 2014/53/EU. As a certification body (TCB, FCB, and RCB), Phoenix Testlab is also able to approve these products for the markets in the USA, Canada, and Japan.

Standards and regulations

All relevant standards and regulations are used as the basis for the development and maintenance of our products.

International standards are subject to continuous changes as a result of harmonization and new developments. In line with this process, the current version of all standards that are relevant to our products is documented in the product area on our website at phoenixcontact.net/products

Online product information service on the world wide web

Phoenix Contact is continuously extending its product range.

Within the scope of our product monitoring obligation, all products are subject to an improvement process.

The Internet is an ideal platform to quickly communicate new product developments and improvements to the market.

You can quickly access the relevant Phoenix Contact website for your region via phoenixcontact.com. There you will always find an up-to-date overview of products, solutions, and services from Phoenix Contact. This includes technical documents such as data sheets and user manuals, current driver and demo software, and a direct link to the relevant contact person.

Touch protection

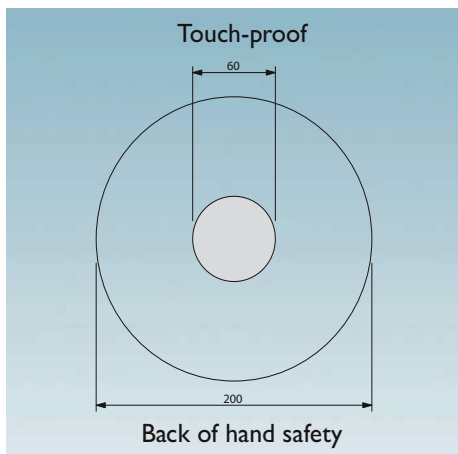

Example: pressure actuation

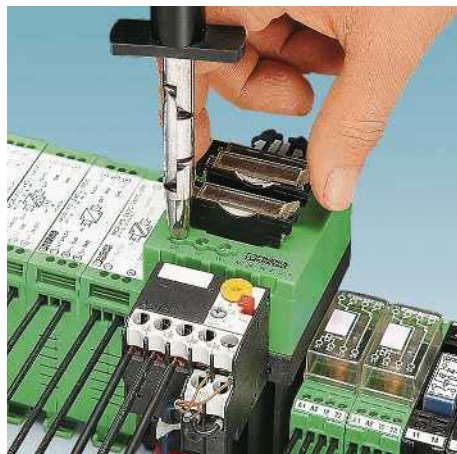

Touch-proof



Back of hand safety

The accident prevention regulations BGV A 2 issued by the German employer's liability insurance association for precision mechanics and electrical engineering apply to the operators of electrical systems and are aimed at the prevention of electrical accidents by means of special safety requirements.

These regulations contain specifications regarding the safety distances for work, operation, and occasional handling in the proximity of "live parts" in low-voltage systems up to 1,000 V ~ or 1,500 V –.

- Work with live parts is only permitted once they have been de-energized.

Operation in the proximity of live parts is only permitted if these parts are de-energized or are protected against direct contact (§ 6). The following safety measures apply when working in the proximity of live parts:

- Provision of the de-energized state for the duration of the work
- Ensure shock protection is in place in the form of covers or barriers during the work
- Assurance that proximity limits will not be violated (§ 7)

The term "occasional handling" has been introduced for the operation of elements such as pushbuttons, rocker arms or rotary buttons in the proximity of live parts.

According to VDE 0105-1, this is covered by "operation with partial protection against direct contact".

Detailed specifications for "occasional handling" can be found in DIN VDE 0106-100. This specifies to what degree live parts in the proximity of operating elements are to be protected against contact. The basis for this is the definition of a "protection area for occasional handling"; this is the area into which the user must reach in order to handle the machine.

The most important thing is that an area formed by an even envelope curve 30 mm in radius must surround the live parts. This area must be **touch-proof**, i.e., the live parts of the electrical device must not be within reach of the VDE test finger in accordance with IEC 60529/DIN VDE 0470-1 (test finger).

Back of hand safety is specified for the "rest of the area" up to 100 mm around the operating element. **Back of hand safety** means that when a force of 50 N is applied to a ball with a diameter of 50 mm, this does not come into contact with the live parts of the equipment. No special measures for ensuring contact safety are stipulated outside this area.

Note: systems and equipment that are operated with PELV up to 25 V ~ or 60 V – are considered to be protected against "direct contact".

According to § 5, Subsection 4 of the BGV A 2 regulations, there is no need to test the condition of the system prior to initial startup if the company has confirmation from the manufacturer or installer that the electrical systems and equipment conform to BGV A 2. The confirmation required relates to systems and equipment that have been installed and are ready for operation and can only be issued by the installer or installation company. The manufacturer of the electrical equipment can only issue a confirmation that products have been produced in accordance with the relevant electrotechnical DIN VDE regulations stipulated in BGV A 2. The installer must bear this in mind when selecting the equipment to be used.

In the field of connection technology, Phoenix Contact offers a wide range of products which are touch-proof or can be protected against contact by means of covers. Depending on the conditions, all of this must be taken into account when selecting

the individual types of terminal blocks and accessories.

Quality features of insulating housings

Thermoplastics

The majority of our insulating housing is made from thermoplastic materials. Roughly speaking, these can be divided into amorphous and semi-crystalline substances. Thermoplastics are processed using the efficient and environmentally-friendly injection molding process. They have good recycling properties and can be re-used. We use many materials that are modified in different ways to meet the demanding requirements of electrical and electronic modules, devices, and systems with regard to their mechanical, thermal, and electrical properties.

Behavior of plastics under the influence of temperature (operating temperatures, mechanical influences)

Plastics undergo a process referred to as thermal aging when they are subjected to heat over long periods. This process causes changes in the mechanical and electrical properties of the material. External influences such as radiation and additional mechanical, chemical, and electrical stresses amplify this effect. Special tests on samples can yield characteristic data which provides a good means of drawing comparisons between different plastics. However, applying these characteristics to an evaluation of molded plastic parts is only possible to a limited extent, and can only give the designer a rough guide when it comes to selecting a plastic material. This catalog uses the following assessment criteria: the **RTI value** in accordance with UL746B/ANSI 746 B (elec. based on electric strength) and the **Ti value** in accordance with IEC 60216-1 (based on a 50% reduction in tensile strength after 20,000 hours).

IEC 60947-7-1/EN 60947-7-1 specifies a permissible temperature increase of 45 K for terminal blocks under nominal load. Phoenix Contact terminal blocks satisfy this requirement.

The properties of plastics are not only affected by the influence of heat as described above; they also undergo changes as a result of cold influences. When subjected to cold as well as low levels of humidity, plastics become increasingly brittle with the result that they are no longer capable of withstanding the same mechanical loads. As the table on the right shows, the plastics concerned can be used down to a temperature of -40°C, but only without a mechanical load. As far as the products presented in the catalog are concerned, it is the ambient temperature specified in each case that is to be regarded as definitive for operation. Regardless of the plastics used, this may be subject to further restrictions (e.g., limited to -20°C) as a

result of the components used or other restrictive parameters.

At very low temperatures, this means that any form of mechanical load on the plastic components must be avoided (e.g., mounting of products on/removal of products from the DIN rail, actuation of terminal points, locking/ejection of relays from bases, prizing out of plug-in bridges, bending of cables and lines, etc.), as there is always an associated risk of damage. Unless otherwise indicated, it is recommended that you carry out the specified mounting/operational tasks in a temperature range from -10°C to +40°C.

Inflammability characteristics of plastics (UL 94)

The inflammability tests for plastics have been defined by the Underwriters Laboratory (USA) in regulation UL 94. This applies to all areas of application, particularly in electrical engineering. A horizontal or vertical test is carried out at the test laboratory to determine the inflammability of the plastic material with a naked flame. In order of increasing flame-retardant behavior, the evaluation classes are HB, V2, V1, V0, and 5V. Test results are recorded on "yellow cards" and are published annually in the **Recognized Component Directory**.

Thermoplastics: non-reinforced polyamide, PA

We use the modern, semi-crystalline insulation material, polyamide, which is now an essential component in electrical engineering and electronics. It has long occupied a leading position and is authorized for use by the relevant approval authorities such as the CSA, NEMKO, KEMA, PTB, SEV, UL, VDE, etc.

Polyamide has excellent electrical, mechanical, chemical, and other properties even at high operating temperatures. Brief peak temperatures of up to approximately 200°C are permitted as a result of heat aging stabilization. Depending on the type (PA 4.6, 6.6, 6.10, etc.), its melting point is in the region of 215°C to 295°C.

Polyamide absorbs moisture from its surroundings, on average 2.8%. However, this moisture is not crystallization water in the plastic itself, but chemically bonded H₂O groups in the molecular structure. This makes the plastic flexible and resistant to breakage, even at temperatures as low as -40°C. As per UL 94, PA has a flammability rating of V2 to V0.

Thermoplastics: polyester, PBT

We use the semi-crystalline thermoplastic polyester in non-reinforced and fiberglass-reinforced variants for special applications which require increased dimensional and form stability.

In addition to the high operating temperature, the material is characterized by excellent mechanical strength and hardness. Polyester does not absorb moisture from its surroundings. Therefore, PBT is particularly suitable for strips, for example, that are soldered onto PCBs and are subsequently required to pass a burn-in test where they are subjected to the influence of heat. As per UL 94, PBT has a flammability rating of V2 to V0.

Thermoplastics: polycarbonate, PC

Polycarbonate combines many advantages such as rigidity, impact strength, transparency, dimensional stability, good insulation properties, and resistance to heat.

The amorphous material only absorbs moisture to a very limited degree, and is used for items such as large, rigid electronic component housings.

In its transparent form, polycarbonate is particularly suitable for use as a material for cover profiles or marking materials.

PC has good resistance properties against mineral acids, saturated aliphatic hydrocarbons, gasoline, greases, and oils.

This material is not very resistant to solvents, benzene, alkalis, acetone, and ammonia. Strain cracks may result from contact with certain chemicals.

As per UL 94, PC has a flammability rating of V2 to V0.

Thermoplastics: polycarbonate fiber-reinforced, PC-F

Compared to non-reinforced materials, fiber-reinforced polycarbonates feature greater rigidity and impact strength, and have a higher operating temperature. Otherwise, their properties are largely the same as those of non-reinforced polycarbonate.

Thermoplastics: ABS

We use the thermoplastic molding compound ABS for products which must have good impact and notched impact properties in addition to high mechanical stability and rigidity. The products are characterized by their resistance to chemicals and stress cracking due to their special surface quality and hardness.

The characteristic thermal properties provide good dimensional stability at both low and high temperatures. Products made from ABS can be coated with metallic

surfaces, e.g., nickel.

As per UL 94, the molding compound used has a flammability rating of HB to V0.

Properties	Unit/level	Polyamide PA	Polyester PBT	Polycarbonate PC	Polycarbonate PC-F	ABS
Operating temperature RTI **	°C	≤ 105	≤ 105	≤ 125	≤ 120	≤ 80
Minimum temperature (without mechanical load)	°C	-40	-40	-40	-40	-40
Electric strength IEC 60243-1/DIN VDE 0303-21	kV/cm	600	400	>300		850
Resistance to creepage IEC 60112/DIN VDE 0303-1	CTI...M	550	225	175		200
	CTI...	600	225	175	175	600
Tropical and termite resistance		Good	Good	Good		
Specific contact resistance IEC 60093/VDE 0303 Part 30; IEC 60167/VDE 0303 Part 31	Ω cm	10 ¹²	10 ¹⁶	>10 ¹⁶	>10 ¹⁴	10 ¹⁴
Surface resistance IEC 60093/VDE 0303 Part 30; IEC 60167/VDE 0303 Part 31	Ω	10 ¹⁰	10 ¹³	>10 ¹⁴		10 ¹³
Flammability rating UL 94		V2-V0	V0	V2-V0	V0	HB-V0

* As per UL 746 B/ANSI 746 B (elec.)

** Minimum value

Dimensions

Dimensions: Width/Height/Depth



The dimensions “**Width/Height/Depth**” are defined as follows for all DIN-rail-mountable products:

- **Width**: measurement taken along the DIN rail
- **Height**: measurement taken across the DIN rail
- **Depth**: measurement taken starting from the mounting plate and including the NS 35/7,5 DIN rail (EN 60715)

The width, height, and depth never change, even if the products shown in this catalog happen to be photographed from two different perspectives (horizontal or vertical).

To make things easier for you, one of the two symbols shown above has been included next to each product photo:

EMC: Class A product:

In accordance with statutory regulations, our products are indicated with this footnote if they are intended for use in industrial environments. This means that the permitted limit values for residential applications may be exceeded in the event of conducted and emitted disturbance variables. In such cases, the operator may have to take additional safety measures in order to ensure electromagnetic compatibility in residential applications.

Note:

Subject to changes that serve the purpose of technical progress.

Connection cross section

The rated cross section of terminal blocks must be specified by the manufacturer in accordance with IEC 60947-7-1. The rated cross section is the maximum conductor cross section that can be connected in solid, multi-stranded or fine-stranded versions subject to specific thermal, mechanical, and electrical requirements.

The manufacturer must also specify the **rated connection capacity**, i.e., the area of connectable conductors as well as the number of conductors which can be connected simultaneously and the necessary preparation of the conductor ends. The conductors can be **rigid**

(solid or multi-stranded) or flexible **(fine-stranded)**.

These values can be found in the product-specific technical data.

The rated connection capacity of Phoenix Contact terminal blocks usually exceeds standard requirements, which specify that it must only be possible to connect one conductor with one of the two next smallest cross sections, excluding the rated cross section (standardized for the cross section range from 0.2 to 35 mm²).

In addition, conductors with a rated cross section can usually be wired with

ferrules with plastic sleeve.

Phoenix Contact terminal blocks are designed to allow copper wires to be connected to them untreated. "Special treatment" or the use of ferrules – both permitted in accordance with IEC 60947-7-1 – is not required. If ferrules are nevertheless used to protect flexible conductors against splicing, the connection capacity of the flexible conductor is generally reduced by one level.

Structure and dimensions of connecting cables

Cross section	Solid		Multi-stranded		Fine-stranded		Gauge no.	American Wire Gauge [AWG]					
	Diameter max. dimension	Number of wires	Diameter max. dimension	Number of wires (minimum number)	Diameter max. dimension	Number of wires (guide value)		Rigid wires			Flexible wires		
								[mm ²]	[Ø mm]	[circ. mils]	[mm ²]	[Ø mm]	[circ. mils]
0.2	0.5	1	–	–	–	–	24	0.51	404	0.21	–	–	–
0.5	0.9	1	1.1	7	1.1	16	20	0.81	1022	0.52	0.97	1111	0.56
0.75	1.0	1	1.2	7	1.3	24	18	1.02	1620	0.82	1.16	1600	0.82
1	1.2	1	1.4	7	1.5	32	(17)	1.15	2050	1.04	–	–	–
–	–	–	–	–	–	–	16	1.29	2580	1.31	1.50	2580	1.32
1.5	1.5	1	1.7	7	1.8	30	(15)	1.45	3260	1.65	–	–	–
–	–	–	–	–	–	–	14	1.63	4110	2.08	1.85	4100	2.09
2.5	1.9	1	2.2	7	2.3	50	(13)	1.83	5180	2.63	–	–	–
–	–	–	–	–	–	–	12	2.05	6530	3.31	2.41	6500	3.32
4	2.4	1	2.7	7	2.9	56	(11)	2.30	8230	4.17	–	–	–
–	–	–	–	–	–	–	10	2.59	10380	5.26	2.95	10530	5.37
6	2.9	1	3.3	7	3.9	84	(9)	2.91	13100	6.63	–	–	–
–	–	–	–	–	–	–	8	3.26	16510	8.37	3.73	16625	8.48

Tightening torque of terminal block screws

IEC 60947-1/EN 60947-1, modified, Table 4 specifies tightening torques for screw connections based on the screw size for electrical and mechanical type tests.

Extract from IEC 60947-1/EN 60947-1, Table 4

The IEC torque and the recommended torque for Phoenix Contact terminal blocks are specified

Thread	Head screw with slot	
	Torque [Nm]	Recommended tightening torque [Nm]
M2.5 (M2.6)	0.4	0.4 - 0.5
M3	0.5	0.5 - 0.6
M3.5	0.8	0.8 - 1.0
M4	1.2	1.2 - 1.5

Current carrying capacity

Standard IEC 60947-7-1/EN 60947-7-1/ DIN VDE 0611-1 specifies the test currents for the individual conductor cross sections listed in the adjacent table. The corresponding currents are listed with the connection data for the individual terminal blocks. The type tests of terminal blocks are based on this data.

Test currents in accordance with IEC 60947-7-1/EN 60947-7-1, Table 5

Rated cross section	[mm ²]	0.2	0.5	0.75	1.0	1.5	2.5	4	6	10	16
Test current	[A]	4	6	9	13.5	17.5	24	32	41	57	76

Certification authorities and marks

Certification authorities and approvals	Country code	Explosion protection	Country code	Marine classification societies	Country code
CB scheme IECEE CB Scheme (in combination with certifying body)	International	International Electrotechnical Commission	International	DNV GL - MARITIME	DE
CCA CENELEC Certification Agreement (CCA inspection report) (in combination with certifying body)	EU	ATEX Directive	EU	Bureau Veritas	FR
Canadian Standards Association (CSA)	CA	Canadian Standards Association (CSA)	CA	Lloyd's Register of Shipping	GB
Canadian Standards Association (CSA) - CSA approval for the USA -	US	Canadian Standards Association (CSA) - CSA approval for the USA -	US	ClassNK Nippon Kaiji Kyokai	JP
Canadian Standards Association (CSA) combined logo - CSA approval for Canada and the USA -	CA US	Canadian Standards Association (CSA) combined logo - CSA approval for Canada and the USA -	CA US	Polski Rejestr Statków	PL
Underwriters Laboratories Inc. (UL)	US	Underwriters Laboratories Inc. (UL)	US	Russian Maritime Register of Shipping	RU
Underwriters Laboratories Inc. (UL) - UL approval for Canada -	CA	Underwriters Laboratories Inc. (UL) - UL approval for Canada -	CA	Korean Register of Shipping	KR
Underwriters Laboratories Inc. (UL) combined logo - UL approval for the USA and Canada -	US CA	Underwriters Laboratories Inc. (UL) combined logo - UL approval for the USA and Canada -	US CA	American Bureau of Shipping	US
INSIEME PER LA QUALITA'E LA SICUREZZA	IT	FM Approvals	US	Registro Italiano Navale	IT
EAC Eurasian Conformity	EAEU	FM Approvals - FM approval for Canada -	CA		
DEKRA Certification B.V.	NL	FM Approvals - FM approval for the USA and Canada -	US CA		
Österreichischer Verband für Elektrotechnik	AT	Eurasian Conformity for Ex-products	EAEU		
Eurofins Electrosuisse Product Testing AG SEV certification scheme	CH	Korean Certification Mark for Ex-products	KR		
Verband Deutscher Elektrotechniker e.V. (VDE) - Approval of drawings - Reports with production monitoring	DE	National Institute of Metrology, Standardization and Industrial Quality	BR		
Berufsgenossenschaft (BG) GS – Geprüfte Sicherheit (tested safety)	DE	National Supervision and Inspection Center for Explosion Protection and Safety of Instrumentation	CN		
Intertek ETL Listed - Approval for the USA -	US	Corp. Centro de Investigación y Desarrollo Tecnológico del Sector Eléctrico	CO		
Intertek ETL Listed - Approval for Canada -	CA				
Intertek ETL Listed - Approval for the USA and Canada -	US CA				
TÜV Rheinland Industrie Service GmbH	DE				
China Compulsory Certification	CN				
Korean Certification Mark	KR				

Index

Alphabetical

Type	Order No.	Page	Type	Order No.	Page	Type	Order No.	Page	Type	Order No.	Page
B											
BRIDGE COVER	2906240	38	CABLE-D-9SUB/F/OE/0,25/S/1,5M	2926030	576	CABLE-D15SUB/B/B/200/KONFEK/S	2305457	571	CABLE-D37SUB/B/S/400/KONFEK/S	2302243	570
BRIDGE-2	2900746	38	CABLE-D-9SUB/F/OE/0,25/S/2,0M	2926043	576	CABLE-D15SUB/B/B/300/KONFEK/S	2305460	571	CABLE-D37SUB/B/S/600/KONFEK/S	2302256	570
BRIDGE-2-3M	2901543	39	CABLE-D-9SUB/F/OE/0,25/S/3,0M	2926056	576	CABLE-D15SUB/B/B/HF/S/ 1,0M	1066597	573	CABLE-D37SUB/B/S/HF/S/ 1,0M	1066680	572
BRIDGE-3	2900747	38	CABLE-D-9SUB/F/OE/0,25/S/4,0M	2926069	576	CABLE-D15SUB/B/B/HF/S/ 2,0M	1066598	573	CABLE-D37SUB/B/S/HF/S/ 2,0M	1066609	572
BRIDGE-3-3M	2901656	39	CABLE-D-9SUB/M/OE/0,25/S/2,0M	2926399	576	CABLE-D15SUB/B/B/HF/S/ 3,0M	1066599	573	CABLE-D37SUB/B/S/HF/S/ 3,0M	1066611	572
BRIDGE-4	2900748	38	CABLE-D-9SUB/M/OE/0,25/S/3,0M	2926409	576	CABLE-D15SUB/B/S/ 50/KONFEK/S	2302052	570	CABLE-D37SUB/S/S/100/KONFEK/S	2305664	571
BRIDGE-4-3M	2901659	39	CABLE-D-9SUB/M/OE/0,25/S/4,0M	2926412	576	CABLE-D15SUB/B/S/100/KONFEK/S	2302065	570	CABLE-D37SUB/S/S/HF/S/ 1,0M	1066615	573
BRIDGE-5	2900749	38	CABLE-D-9SUB/M/OE/0,25/S/1,5M	2926386	576	CABLE-D15SUB/B/S/150/KONFEK/S	2302078	570	CABLE-D37SUB/S/S/300/KONFEK/S	2305680	571
BRIDGE-5-3M	2901545	39	CABLE-D-9SUB/M/OE/0,25/S/2,0M	2926399	576	CABLE-D15SUB/B/S/200/KONFEK/S	2302081	570	CABLE-D37SUB/S/S/HF/S/ 1,0M	1066612	573
BRIDGE-6	2900750	38	CABLE-D-9SUB/M/OE/0,25/S/3,0M	2926409	576	CABLE-D15SUB/B/S/300/KONFEK/S	2302094	570	CABLE-D37SUB/S/S/HF/S/ 2,0M	1066614	573
BRIDGE-6-3M	2901697	39	CABLE-D-9SUB/M/OE/0,25/S/4,0M	2926412	576	CABLE-D15SUB/B/S/400/KONFEK/S	2302104	570	CABLE-D37SUB/S/S/HF/S/ 3,0M	1066615	573
BRIDGE-7	2900751	38	CABLE-D-9SUB/M/OE/0,25/S/6,0M	2926425	576	CABLE-D15SUB/B/S/600/KONFEK/S	2302117	570	CABLE-D50SUB-B-B-HF-S/...	1075557	573
BRIDGE-7-3M	2901698	39	CABLE-D-15SUB-F-OE-0,25-S/...	2900905	576	CABLE-D15SUB/B/S/HF/S/ 1,0M	1066600	572	CABLE-D50SUB-B-S-HF-S/...	1075554	572
BRIDGE-8	2900752	38	CABLE-D-15SUB-M-OE-0,25-S/...	2900910	576	CABLE-D15SUB/B/S/HF/S/ 2,0M	1066602	572	CABLE-D50SUB-S-S-HF-S/...	1075553	573
BRIDGE-8-3M	2901700	39	CABLE-D-15SUB-F/OE/0,25/S/0,5M	2926085	576	CABLE-D15SUB/B/S/HF/S/ 3,0M	1066603	572	CABLE-D50SUB/B/B/100/KONFEK/S	2305541	571
BRIDGE-9	2900753	38	CABLE-D-15SUB-F/OE/0,25/S/1,0M	2926098	576	CABLE-D15SUB/S/S/100/KONFEK/S	2305606	571	CABLE-D50SUB/B/B/200/KONFEK/S	2305554	571
BRIDGE-9-3M	2901701	39	CABLE-D-15SUB/F/OE/0,25/S/1,5M	2926108	576	CABLE-D15SUB/S/S/200/KONFEK/S	2305619	571	CABLE-D50SUB/B/B/300/KONFEK/S	2305567	571
BRIDGE-10	2900754	38	CABLE-D-15SUB/F/OE/0,25/S/2,0M	2926111	576	CABLE-D15SUB/S/S/300/KONFEK/S	2305622	571	CABLE-D50SUB/B/S/HF/S/ 1,0M	1066672	573
BRIDGE-10-3M	2901702	39	CABLE-D-15SUB/F/OE/0,25/S/3,0M	2926124	576	CABLE-D15SUB/S/S/HF/S/ 1,0M	1066604	573	CABLE-D50SUB/B/B/HF/S/ 2,0M	1066673	573
BRIDGE-PT 2	2904490	39	CABLE-D-15SUB/F/OE/0,25/S/4,0M	2926137	576	CABLE-D15SUB/S/S/HF/S/ 2,0M	1066606	573	CABLE-D50SUB/B/B/HF/S/ 3,0M	1066674	573
BRIDGE-PT 3	2904491	39	CABLE-D-15SUB/F/OE/0,25/S/6,0M	2926140	576	CABLE-D15SUB/S/S/HF/S/ 3,0M	1066607	573	CABLE-D50SUB/B/S/ 50/KONFEK/S	2302269	570
BRIDGE-PT 4	2904492	39	CABLE-D-15SUB/M/OE/0,25/S/0,5M	2926438	576	CABLE-D15SUB/B/B/100/KONFEK/S	1075560	573	CABLE-D50SUB/B/S/100/KONFEK/S	2302272	570
BRIDGE-PT 5	2904493	39	CABLE-D-15SUB/M/OE/0,25/S/1,0M	2926441	576	CABLE-D25SUB-B-S-HF-S/...	1075559	572	CABLE-D50SUB/B/S/150/KONFEK/S	2302285	570
BRIDGE-PT 6	2904494	39	CABLE-D-15SUB/M/OE/0,25/S/1,5M	2926454	576	CABLE-D25SUB-S-S-HF-S/...	1075558	573	CABLE-D50SUB/B/S/200/KONFEK/S	2302298	570
BRIDGE-PT 7	2904495	39	CABLE-D-15SUB/M/OE/0,25/S/2,0M	2926467	576	CABLE-D25SUB/B/2X14/100/TU812	2304649	469	CABLE-D50SUB/B/S/300/KONFEK/S	2302308	570
BRIDGE-PT 8	2904496	39	CABLE-D-15SUB/M/OE/0,25/S/3,0M	2926470	576	CABLE-D25SUB/B/2X14/200/TU812	2304652	469	CABLE-D50SUB/B/S/400/KONFEK/S	2302311	570
BRIDGE-PT 9	2904497	39	CABLE-D-15SUB/M/OE/0,25/S/4,0M	2926483	576	CABLE-D25SUB/B/2X14/300/TU812	2304665	469	CABLE-D50SUB/B/S/600/KONFEK/S	2302324	570
BRIDGE-PT 10	2904498	39	CABLE-D-15SUB/M/OE/0,25/S/6,0M	2926496	576	CABLE-D25SUB/B/2X14/500/TU812	2304678	469	CABLE-D50SUB/B/S/HF/S/ 1,0M	1066678	572
			CABLE-D-25SUB-F-OE-0,25-S/...	2900906	576	CABLE-D25SUB/B/2X14/TU812/...	2304681	469	CABLE-D50SUB/B/S/HF/S/ 2,0M	1066679	572
			CABLE-D-25SUB-M-OE-0,25-S/...	2900911	576	CABLE-D25SUB/B/B/100/KONFEK/S	2305473	571	CABLE-D50SUB/B/S/HF/S/ 3,0M	1066681	572
			CABLE-D-25SUB/F/OE/0,25/S/0,5M	2926153	576	CABLE-D25SUB/B/B/200/KONFEK/S	2305486	571	CABLE-D50SUB/S/S/100/KONFEK/S	2305693	571
			CABLE-D-25SUB/F/OE/0,25/S/1,0M	2926166	576	CABLE-D25SUB/B/B/300/KONFEK/S	2305499	571	CABLE-D50SUB/S/S/200/KONFEK/S	2305703	571
			CABLE-D-25SUB/F/OE/0,25/S/1,5M	2926179	576	CABLE-D25SUB/B/B/HF/S/ 1,0M	1066657	573	CABLE-D50SUB/S/S/300/KONFEK/S	2305716	571
			CABLE-D-25SUB/F/OE/0,25/S/2,0M	2926182	576	CABLE-D25SUB/B/B/HF/S/ 2,0M	1066660	573	CABLE-D50SUB/S/S/HF/S/ 1,0M	1066682	573
			CABLE-D-25SUB/F/OE/0,25/S/3,0M	2926195	576	CABLE-D25SUB/B/B/HF/S/ 3,0M	1066664	573	CABLE-D50SUB/S/S/HF/S/ 2,0M	1066683	573
			CABLE-D-25SUB/F/OE/0,25/S/4,0M	2926205	576	CABLE-D25SUB/B/S/ 50/KONFEK/S	2302120	570	CABLE-D50SUB/S/S/HF/S/ 3,0M	1066684	573
			CABLE-D-25SUB/F/OE/0,25/S/6,0M	2926218	576	CABLE-D25SUB/B/S/100/KONFEK/S	2302133	570	CABLE-FCN40-4X14-OMR-IN/...	2302816	484
			CABLE-D-25SUB/M/OE/0,25/S/0,5M	2926506	576	CABLE-D25SUB/B/S/150/KONFEK/S	2302146	570	CABLE-FCN40-4X14-OMR-OUT/...	2302832	484
			CABLE-D-25SUB/M/OE/0,25/S/1,0M	2926519	576	CABLE-D25SUB/B/S/200/KONFEK/S	2302159	570	CABLE-FCN40/1X50/0,5M/IM/MEL	2903468	483
			CABLE-D-25SUB/M/OE/0,25/S/1,5M	2926522	576	CABLE-D25SUB/B/S/300/KONFEK/S	2302162	570	CABLE-FCN40/1X50/0,5M/IP/MEL	2903476	483
			CABLE-D-25SUB/M/OE/0,25/S/2,0M	2926535	576	CABLE-D25SUB/B/S/400/KONFEK/S	2302175	570	CABLE-FCN40/1X50/0,5M/M340	2321635	491
			CABLE-D-25SUB/M/OE/0,25/S/3,0M	2926548	576	CABLE-D25SUB/B/S/600/KONFEK/S	2302188	570	CABLE-FCN40/1X50/0,5M/S7-IN	2321091	504
			CABLE-D-25SUB/M/OE/0,25/S/4,0M	2926551	576	CABLE-D25SUB/B/S/HF/S/ 1,0M	1066665	572	CABLE-FCN40/1X50/0,5M/S7-OUT	2321017	504
			CABLE-D-25SUB/M/OE/0,25/S/6,0M	2926564	576	CABLE-D25SUB/B/S/HF/S/ 2,0M	1066666	572	CABLE-FCN40/1X50/1,0M/IM/MEL	2903469	483
			CABLE-D-37SUB-F-OE-0,25-S/...	2900907	577	CABLE-D25SUB/B/S/HF/S/ 3,0M	1066667	572	CABLE-FCN40/1X50/1,0M/IP/MEL	2903477	483
			CABLE-D-37SUB-M-OE-0,25-S/...	2900912	577	CABLE-D25SUB/S/S/100/KONFEK/S	2305635	571	CABLE-FCN40/1X50/1,0M/M340	2321648	491
			CABLE-D-37SUB/F/OE/0,25/S/0,5M	2926221	577	CABLE-D25SUB/S/S/200/KONFEK/S	2305648	571	CABLE-FCN40/1X50/1,0M/S7-IN	2321101	504
			CABLE-D-37SUB/F/OE/0,25/S/1,0M	2926234	577	CABLE-D25SUB/S/S/300/KONFEK/S	2305651	571	CABLE-FCN40/1X50/1,0M/S7-OUT	2321020	504
			CABLE-D-37SUB/F/OE/0,25/S/1,5M	2926247	577	CABLE-D25SUB/S/S/HF/S/ 1,0M	1066668	573	CABLE-FCN40/1X50/2,0M/IM/MEL	2903470	483
			CABLE-D-37SUB/F/OE/0,25/S/2,0M	2926250	577	CABLE-D25SUB/S/S/HF/S/ 2,0M	1066669	573	CABLE-FCN40/1X50/2,0M/IP/MEL	2903478	483
			CABLE-D-37SUB/F/OE/0,25/S/3,0M	2926263	577	CABLE-D25SUB/S/S/HF/S/ 3,0M	1066671	573	CABLE-FCN40/1X50/2,0M/M340	2321651	491
			CABLE-D-37SUB/F/OE/0,25/S/4,0M	2926276	577	CABLE-D37-M2,5-4X14-X81-I/...	2302706	482	CABLE-FCN40/1X50/2,0M/S7-IN	2321114	504
			CABLE-D-37SUB/F/OE/0,25/S/6,0M	2926289	577	CABLE-D37-M2,5-4X14-Y81P-O/...	2302696	482	CABLE-FCN40/1X50/2,0M/S7-OUT	2321033	504
			CABLE-D-37SUB/M/OE/0,25/S/0,5M	2926577	577	CABLE-D37-M2,5/4X14/ 50/X81-I	2302515	482	CABLE-FCN40/1X50/3,0M/IM/MEL	2903471	483
			CABLE-D-37SUB/M/OE/0,25/S/1,0M	2926580	577	CABLE-D37-M2,5/4X14/ 50/Y81P-O	2302476	482	CABLE-FCN40/1X50/3,0M/M340	2903479	483
			CABLE-D-37SUB/M/OE/0,25/S/1,5M	2926593	577	CABLE-D37-M2,5/4X14/100/X81-I	2302528	482	CABLE-FCN40/1X50/3,0M/M340	2321664	491
			CABLE-D-37SUB/M/OE/0,25/S/2,0M	2926603	577	CABLE-D37-M2,5/4X14/100/Y81P-O	2302489	482	CABLE-FCN40/1X50/3,0M/S7-IN	2321127	504
			CABLE-D-37SUB/M/OE/0,25/S/3,0M	2926616	577	CABLE-D37-M2,5/4X14/200/X81-I	2302531	482	CABLE-FCN40/1X50/3,0M/S7-OUT	2321046	504
			CABLE-D-37SUB/M/OE/0,25/S/4,0M	2926629	577	CABLE-D37-M2,5/4X14/200/Y81P-O	2302492	482	CABLE-FCN40/1X50/4,0M/IM/MEL	2903472	483
			CABLE-D-37SUB/M/OE/0,25/S/6,0M	2926632	577	CABLE-D37-M2,5/4X14/300/X81-I	2302544	482	CABLE-FCN40/1X50/4,0M/IP/MEL	2903480	483
			CABLE-D-50SUB-F-OE-0,25-S/...	2900908	577	CABLE-D37-M2,5/4X14/300/Y81P-O	2302502	482	CABLE-FCN40/1X50/4,0M/M340	2321677	491
			CABLE-D-50SUB-M-OE-0,25-S/...	2900913	577	CABLE-D37SUB-B-B-HF-S/...	1075563	573	CABLE-FCN40/1X50/4,0M/S7-IN	2321130	504
			CABLE-D-50SUB/F/OE/0,25/S/0,5M	2926292	577	CABLE-D37SUB-B-S-HF-S/...	1075562	572	CABLE-FCN40/1X50/4,0M/S7-OUT	2321059	504
			CABLE-D-50SUB/F/OE/0,25/S/1,0M	2926302	577	CABLE-D37SUB-S-S-HF-S/...	1075561	573	CABLE-FCN40/1X50/6,0M/IM/MEL	2903473	483
			CABLE-D-50SUB/F/OE/0,25/S/1,5M	2926315	577	CABLE-D37SUB/B/B/ 100/KONFEK/S	2305509	571	CABLE-FCN40/1X50/6,0M/IP/MEL	2903481	483
			CABLE-D-50SUB/F/OE/0,25/S/2,0M	2926328	577	CABLE-D37SUB/B/B/ 200/KONFEK/S	2305512	571	CABLE-FCN40/1X50/6,0M/M340	2321680	491
			CABLE-D-50SUB/F/OE/0,25/S/3,0M	2926331	577	CABLE-D37SUB/B/B/ 300/KONFEK/S	2305525	571	CABLE-FCN40/1X50/6,0M/S7-IN	2321143	504
			CABLE-D-50SUB/F/OE/0,25/S/4,0M	2926344	577	CABLE-D37SUB/B/B/ 400/KONFEK/S	2900759	571	CABLE-FCN40/1X50/6,0M/S7-OUT	2321062	504
			CABLE-D-50SUB/F/OE/0,25/S/6,0M	2926357	577	CABLE-D37SUB/B/B/ 600/KONFEK/S	2900760	571	CABLE-FCN40/1X50/8,0M/IM/MEL	2903474	483
			CABLE-D-50SUB/M/OE/0,25/S/0,5M	2926645	577	CABLE-D37SUB/B/B/ 800/KONFEK/S	2900761	571	CABLE-FCN40/1X50/8,0M/IP/MEL	2903482	483
			CABLE-D-50SUB/M/OE/0,25/S/1,0M	2926658	577	CABLE-D37SUB/B/B/1000/KONFEK/S	2900762	571	CABLE-FCN40/1X50/8,0M/M340	2321693	491
			CABLE-D-50SUB/M/OE/0,25/S/1,5M	2926671	577	CABLE-D37SUB/B/B/1500/KONFEK/S	2900763	571	CABLE-FCN40/1X50/8,0M/S7-IN	2321156	504
			CABLE-D-50SUB/M/OE/0,25/S/2,0M	2926674	577	CABLE-D37SUB/B/B/2000/KONFEK/S	2900764	571			

Table with 8 columns: Type, Order No., Page, Type, Order No., Page, Type, Order No., Page. Contains multiple rows of product specifications and part numbers.

Index

Alphabetical

Type	Order No.	Page	Type	Order No.	Page	Type	Order No.	Page	Type	Order No.	Page
EM RI-ADAPTER COMPACT	2902748	37	EMG 22-REL/KSR-230/21/AU/SO46	2940061	446	FA MCR-FD-PM	2908739	183	FLK 16-14-DV-IN/...	2304416	476
EM-2RPT/21AU-R/L-P	2909573	26	EMG 22-REL/KSR-G 24/TRN 5	2949787	456	FA MCR-FD-TUI-UI-2REL-UP	2907780	183	FLK 16-14-DV-OUT/...	2304377	476
EM-2RSC/21AU-R/L-P	2908701	26	EMG 22-REL/KSR-G 24/TRN12	2952363	456	FA MCR-FDS-I-I-OLP	2908782	185	FLK 16-24-DV-AI-EZ-DR/...	2304335	476
EM-CAN-GATEWAY-IFS	2901504	20	EMG 22-REL/KSR-G 24/TRN35	2952350	456	FA MCR-FDS-PM	2908783	185	FLK 16/14/DV-IN/ 50	2304393	476
EM-CPS-225	1002634	52	EMG 30-SP- 4K7LIN	2940252	109	FA MCR-FDS-R250	2908802	193	FLK 16/14/DV-IN/100	2300559	476
EM-CPS-405	1002635	52	EMG 30-SP-10K LIN	2942124	109	FA MCR-HT-D	2908735	192	FLK 16/14/DV-IN/200	2300562	476
EM-CPS-DA-18S/16A-L1	1089439	53	EMG 45-DIO 8E	2950103	266	FA MCR-HT-FH	2908736	192	FLK 16/14/DV-IN/300	2304403	476
EM-CPS-DA-18S/16A-L2	1089440	53	EMG 45-DIO 8E-1N5408	2949389	266	FA MCR-HT-FH-PM	2908738	192	FLK 16/14/DV-IN/400	2305185	476
EM-CPS-DA-18S/16A-L3	1089441	53	EMG 45-DIO 8E/LP	2954798	267	FA MCR-HT-FH-WM	2908737	189	FLK 16/14/DV-OUT/ 30	2304348	476
EM-CPS-DA-18S/63A-L1	1089356	53	EMG 45-DIO 8M-1N5408	2954882	266	FA MCR-HTTS-I-OLP-PT	2908742	189	FLK 16/14/DV-OUT/ 50	2304351	476
EM-CPS-DA-18S/63A-L2	1089442	53	EMG 45-DIO 8P-1N5408	2954879	266	FASTCON PRO-SET	2906227	107	FLK 16/14/DV-OUT/100	2300575	476
EM-CPS-DA-18S/63A-L3	1089446	53	EMG 45-DIO14M	2950129	266	FASTCON PRO-SET-PT	2906228	107	FLK 16/14/DV-OUT/200	2300588	476
EM-CPS-DA-22.5F/16A	1002668	53	EMG 45-DIO14M/LP	2950132	267	FBS 2-6	3030336	358	FLK 16/14/DV-OUT/300	2304364	476
EM-CPS-DA-45C/16A	1002666	53	EMG 45-DIO14P	2950116	266	FBS 2-6 BU	3036932	358	FLK 16/24/DV-AI/EZ-DR/ 30	2304319	476
EM-CPS-DA-45C/25A	1002665	53	EMG 45-LED 14S/24	2952334	267	FBS 2-6 GY	3032237	358	FLK 16/24/DV-AI/EZ-DR/ 50	2304296	476
EM-CPS-DA-45C/32A	1002664	53	EMG 90-DIO 16E/LP	2954808	267	FBS 2-8	3030284	358	FLK 16/24/DV-AI/EZ-DR/100	2301134	476
EM-CPS-DA-45C/45A	1003289	53	EMG 90-DIO 17E	2954895	266	FBS 2-8 BU	3032567	358	FLK 16/24/DV-AI/EZ-DR/200	2301545	476
EM-CPS-DA-45S/16A	1003291	53	EMG 90-DIO 32M	2954934	266	FBS 2-8 GY	3032541	358	FLK 16/24/DV-AI/EZ-DR/300	2304322	476
EM-CPS-DA-45S/32A	1003292	53	EMG 90-DIO 32M/LP	2954785	267	FBS 5-6	3030349	358	FLK 16/EZ-DR/ 50/KONFEK	2299291	566
EM-CPS-DAE-45	1003293	54	EMG 90-DIO 32P	2954918	266	FBS 10-6	3030271	358	FLK 16/EZ-DR/ 100/KONFEK	2299301	566
EM-CPS-DAES-45	1003294	54	EMG-GKS 12	2947035	266	FBS 20-6	3030365	358	FLK 16/EZ-DR/ 150/KONFEK	2299314	566
EM-CPS-DHE-45	1002663	54	EMM 3- 24DC/500AC-16-IFS	2954934	16	FBS 20-6	3032224	358	FLK 16/EZ-DR/ 200/KONFEK	2299327	566
EM-CPS-DHS-45	1003296	54	EMM 3- 24DC/500AC-IFS	2297497	16	FBSR 2-6	3033715	282	FLK 16/EZ-DR/ 300/KONFEK	2299330	566
EM-CPS-PS/3AC/24DC/5	1064922	55	EMM 3-230AC/500AC-16-IFS	2297536	16	FBSR 2-8	3033808	288	FLK 16/EZ-DR/ 400/KONFEK	2299343	566
EM-CPS-TB3/125A	1070299	52	EMM 3-230AC/500AC-IFS	2297507	16	FBSR 3-6	3001594	282	FLK 16/EZ-DR/ 600/KONFEK	2299356	566
EM-CPS-TB3/63A	1002633	52	EMM 3-24DC/500AC-160-EXM-IFS	2908603	18	FBSR 4-6	3001595	282	FLK 16/EZ-DR/ 800/KONFEK	2299369	566
EM-CPS-TS-45	1003295	53	EMM 3-24DC/500AC-90-EXM-IFS	2908602	18	FBSR 5-6	3001596	282	FLK 16/EZ-DR/1000/KONFEK	2299372	566
EM-D-8/4-24DC-IFS	2904473	21	ETD-BL-1T-230	2905813	256	FBS 6-PLC BU	2966812	426	FLK 20/2FLK14/EZ-DR/...	2304487	476
EM-ETH-GATEWAY-IFS	2901988	20	ETD-BL-1T-230-PT	2905814	256	FBST 6-PLC GY	2966825	426	FLK 20/2FLK14/EZ-DR/100/KONFEK	2298470	476
EM-MODBUS-GATEWAY-IFS	2901528	20	ETD-BL-1T-F 10S	2917492	261	FBST 6-PLC RD	2966236	426	FLK 20/2FLK14/EZ-DR/200/KONFEK	2298438	476
EM-PB-GATEWAY-IFS	2297620	20	ETD-BL-1T-F 10S-PT	2901489	261	FBST 8-PLC GY	2967688	426	FLK 20/2FLK14/EZ-DR/300/KONFEK	2300818	476
EM-PNET-GATEWAY-IFS	2904472	20	ETD-BL-1T-F 30MIN	2917515	261	FBST 14-PLC BK	2967691	426	FLK 20/EZ-DR/ 500/KONFEK	2296391	566
EMD-BL-3V-400	2903525	247	ETD-BL-1T-F 30MIN-PT	2901491	261	FBST 500-PLC BU	2966692	426	FLK 20/EZ-DR/ 100/KONFEK	2296401	566
EMD-BL-3V-400-PT	2903526	247	ETD-BL-1T-F-300MIN	2917528	261	FBST 500-PLC GY	2966838	426	FLK 20/EZ-DR/ 150/KONFEK	2296472	566
EMD-BL-C-10	2903521	246	ETD-BL-1T-F-300MIN-PT	2901492	261	FBST 500-PLC RD	2966786	426	FLK 20/EZ-DR/ 200/KONFEK	2296485	566
EMD-BL-C-10-PT	2903522	246	ETD-BL-1T-F-300S	2917502	261	FLK 10/EZ-DR/ 50/KONFEK	2299204	566	FLK 20/EZ-DR/ 300/KONFEK	2296498	566
EMD-BL-PH-480	2903527	247	ETD-BL-1T-F-300S-PT	2901490	261	FLK 10/EZ-DR/ 100/KONFEK	2299217	566	FLK 20/EZ-DR/ 400/KONFEK	2296508	566
EMD-BL-PH-480-PT	2903528	247	ETD-BL-1T-OFF-CC 10S	2917450	261	FLK 10/EZ-DR/ 150/KONFEK	2299220	566	FLK 20/EZ-DR/ 600/KONFEK	2296511	566
EMD-BL-PTC	2906252	248	ETD-BL-1T-OFF-CC 10S-PT	2901485	261	FLK 10/EZ-DR/ 200/KONFEK	2299233	566	FLK 20/EZ-DR/ 800/KONFEK	2296524	566
EMD-BL-PTC-PT	2906253	248	ETD-BL-1T-OFF-CC 30MIN	2917467	261	FLK 10/EZ-DR/ 300/KONFEK	2299246	566	FLK 20/EZ-DR/1000/KONFEK	2296537	566
EMD-BL-V-230	2903523	246	ETD-BL-1T-OFF-CC 30MIN-PT	2901487	261	FLK 10/EZ-DR/ 400/KONFEK	2299259	566	FLK 26/EZ-DR/ 50/KONFEK	2299385	567
EMD-BL-V-230-PT	2903524	246	ETD-BL-1T-OFF-CC-300MIN	2917489	261	FLK 10/EZ-DR/ 600/KONFEK	2299262	566	FLK 26/EZ-DR/ 100/KONFEK	2299398	567
EMD-FL-3V-230	2885773	252	ETD-BL-1T-OFF-CC-300MIN-PT	2901488	261	FLK 10/EZ-DR/ 800/KONFEK	2299275	566	FLK 26/EZ-DR/ 150/KONFEK	2299408	567
EMD-FL-3V-400	2866064	252	ETD-BL-1T-OFF-CC-300S	2917463	261	FLK 10/EZ-DR/1000/KONFEK	2299288	566	FLK 26/EZ-DR/ 200/KONFEK	2299411	567
EMD-FL-3V-500	2867979	252	ETD-BL-1T-OFF-CC-300S-PT	2901486	261	FLK 14/EZ-DR/ 30/KONFEK	2295729	536	FLK 26/EZ-DR/ 300/KONFEK	2299424	567
EMD-FL-3V-690	2885249	252	ETD-BL-1T-ON- 10S	2917379	260	FLK 14/EZ-DR/ 50/KONFEK	2288901	536	FLK 26/EZ-DR/ 400/KONFEK	2299437	567
EMD-FL-C-10	2866022	250	ETD-BL-1T-ON- 10S-PT	2901476	260	FLK 14/EZ-DR/ 150/KONFEK/S	2296977	536	FLK 26/EZ-DR/ 600/KONFEK	2299440	567
EMD-FL-PF-400	2885809	254	ETD-BL-1T-ON- 30MIN	2917395	260	FLK 14/EZ-DR/ 100/KONFEK	2288914	536	FLK 26/EZ-DR/ 800/KONFEK	2299453	567
EMD-FL-RP-480	2900177	254	ETD-BL-1T-ON- 30MIN-PT	2901478	260	FLK 14/EZ-DR/ 100/KONFEK/S	2296980	536	FLK 26/EZ-DR/1000/KONFEK	2299466	567
EMD-FL-V-300	2866048	251	ETD-BL-1T-ON-300MIN	2917405	260	FLK 14/EZ-DR/ 150/KONFEK	2288927	536	FLK 34/EZ-DR/ 50/KONFEK	2299479	567
EMD-SL-3V-400	2866051	253	ETD-BL-1T-ON-300MIN-PT	2901479	260	FLK 14/EZ-DR/ 150/KONFEK/S	2296993	536	FLK 34/EZ-DR/ 100/KONFEK	2299482	567
EMD-SL-3V-400-N	2885278	253	ETD-BL-1T-ON-300S	2917382	260	FLK 14/EZ-DR/ 200/KONFEK	2288930	536	FLK 34/EZ-DR/ 150/KONFEK	2299495	567
EMD-SL-C-OC-10	2866019	250	ETD-BL-1T-ON-300S-PT	2901477	260	FLK 14/EZ-DR/ 200/KONFEK/S	2297002	536	FLK 34/EZ-DR/ 200/KONFEK	2299505	567
EMD-SL-C-UC-10	2867937	250	ETD-BL-1T-ON-CC 10S	2917418	261	FLK 14/EZ-DR/ 250/KONFEK	2288943	536	FLK 34/EZ-DR/ 300/KONFEK	2299518	567
EMD-SL-LL-110	2901137	255	ETD-BL-1T-ON-CC 10S-PT	2901480	261	FLK 14/EZ-DR/ 300/KONFEK	2288956	536	FLK 34/EZ-DR/ 400/KONFEK	2299521	567
EMD-SL-LL-230	2885906	255	ETD-BL-1T-ON-CC 30MIN	2917434	261	FLK 14/EZ-DR/ 300/KONFEK/S	2299013	536	FLK 34/EZ-DR/ 600/KONFEK	2299534	567
EMD-SL-PH-400	2866077	253	ETD-BL-1T-ON-CC 30MIN-PT	2901483	261	FLK 14/EZ-DR/ 350/KONFEK	2288969	536	FLK 34/EZ-DR/ 800/KONFEK	2299547	567
EMD-SL-PH-690	2905597	253	ETD-BL-1T-ON-CC-300MIN	2917447	261	FLK 14/EZ-DR/ 400/KONFEK	2288972	536	FLK 34/EZ-DR/1000/KONFEK	2299550	567
EMD-SL-PS- 24AC	2866103	250	ETD-BL-1T-ON-CC-300MIN-PT	2901484	261	FLK 14/EZ-DR/ 400/KONFEK/S	2299026	536	FLK 40-PA/EZ-DR/HF/KS/ 100/YUC	2904747	514
EMD-SL-PS- 24DC	2885359	250	ETD-BL-1T-ON-CC-300S	2917421	261	FLK 14/EZ-DR/ 450/KONFEK	2290847	536	FLK 40-PA/EZ-DR/HF/KS/ 200/YUC	2904748	514
EMD-SL-PS-110AC	2866116	250	ETD-BL-1T-ON-CC-300S-PT	2901481	261	FLK 14/EZ-DR/ 500/KONFEK	2290834	536	FLK 40-PA/EZ-DR/HF/KS/ 300/YUC	2904749	514
EMD-SL-PS-120AC	2885731	250	ETD-BL-2T-I-230	2907713	257	FLK 14/EZ-DR/ 550/KONFEK	2290850	536	FLK 40-PA/EZ-DR/HF/KS/ 400/YUC	2904750	514
EMD-SL-PS-230AC	2866129	250	ETD-BL-2T-I-230-PT	2907714	257	FLK 14/EZ-DR/ 600/KONFEK	2290863	536	FLK 40-PA/EZ-DR/HF/KS/ 500/YUC	2904645	514
EMD-SL-PS45-230AC	2885294	252	ETD-FL-2T-DTI	2866187	264	FLK 14/EZ-DR/ 600/KONFEK/S	2299039	536	FLK 40-PA/EZ-DR/HF/KS/ 600/YUC	2904751	514
EMD-SL-PS45-400AC	2885304	252	ETD-SL-1T-DTF	2866161	265	FLK 14/EZ-DR/ 800/KONFEK	2299563	536	FLK 40-PA/EZ-DR/HF/KS/ 700/YUC	2904752	514
EMD-SL-PS45-500AC	2885317	252	ETD-SL-2T-I	2866174	265	FLK 14/EZ-DR/ 800/KONFEK/S	2299042	536	FLK 40-PA/EZ-DR/HF/KS/ 800/YUC	2904753	514
EMD-SL-PTC	2866093	255				FLK 14/EZ-DR/1000/KONFEK	2299576	536	FLK 40-PA/EZ-DR/HF/KS/ 900/YUC	2904754	514
EMD-SL-V-UV-300	2866035	251				FLK 14/EZ-DR/1000/KONFEK/S	2299055	536	FLK 40-PA/EZ-DR/HF/KS/1000/YUC	2904646	514
EMG 17-OV- 24DC/ 48DC/2	2942810	447				FLK 14/EZ-DR/HF/ 50/KONFEK	2305952	565	FLK 40-PA/EZ-DR/HF/KS/1500/YUC	2904647	514
EMG 17-REL/KSR-G 24/2E/SO38	2941646	449				FLK 14/EZ-DR/HF/ 100/KONFEK	2305965	565	FLK 40-PA/EZ-DR/HF/KS/2000/YUC	2904488	514

Type	Order No.	Page	Type	Order No.	Page	Type	Order No.	Page	Type	Order No.	Page
FLK 40-PA/EZ-DR/KS/900/YUC	2321415	514	FLK 50/4X14/EZ-DR/800/KONFEK	2296757	537	FLKM 50/KDS3-MT/PPA/S7-300	2304490	506	MACX MCR-EX-SL-2NAM-T-SP	2924090	159
FLK 40-PA/EZ-DR/KS/1000/YUC	2314370	514	FLK 50/4X14/EZ-DR/1000/KONFEK	2296773	537	FLKM S115/47X0,75/3,0M/OE	2314985	543	MACX MCR-EX-SL-NAM-2RO	2865450	155
FLK 40-PA/EZ-DR/KS/1500/YUC	2314383	514	FLK 50/EZ-DR/ 50/KONFEK	2290605	536	FLKM S115/47X0,75/5,0M/OE	2314998	543	MACX MCR-EX-SL-NAM-2RO-SP	2924061	155
FLK 40-PA/EZ-DR/KS/2000/YUC	2314532	514	FLK 50/EZ-DR/ 50/KONFEK/S	2299097	536	FLKM S115/S400/SO155	2307248	542	MACX MCR-EX-SL-NAM-2T	2865463	158
FLK 40-PA/EZ-DR/KS/2500/YUC	2314545	514	FLK 50/EZ-DR/ 100/KONFEK	2289078	536	FLKM S115/S7/FLK50/PLC/SO137	2306294	543	MACX MCR-EX-SL-NAM-2T-SP	2924074	158
FLK 40-PA/EZ-DR/KS/3000/YUC	2314558	514	FLK 50/EZ-DR/ 100/KONFEK/S	2299107	536	FLKM S135-431-4UA/S400	2314846	540	MACX MCR-EX-SL-NAM-HO	2907404	160
FLK 40/4X14/EZ-DR/ 50/IB32	2296812	475	FLK 50/EZ-DR/ 150/KONFEK	2289081	536	FLKM S135-460-4UA/1/S400	2314613	541	MACX MCR-EX-SL-NAM-HO-SP	2924045	160
FLK 40/4X14/EZ-DR/ 50/OB32	2296786	475	FLK 50/EZ-DR/ 150/KONFEK/S	2299110	536	FLKM S135-465-4UA/1T/S400	2314875	541	MACX MCR-EX-SL-NAM-NAM	2866006	160
FLK 40/4X14/EZ-DR/ 100/IB32	2296825	475	FLK 50/EZ-DR/ 200/KONFEK	2289094	536	FLKM S135-465-4UA/1U/S400	2314888	541	MACX MCR-EX-SL-NAM-NAM-SP	2924883	160
FLK 40/4X14/EZ-DR/ 100/OB32	2298483	475	FLK 50/EZ-DR/ 200/KONFEK/S	2299123	536	FLKM S135-470-4UC/1/S400	2314626	541	MACX MCR-EX-SL-NAM-R	2865434	154
FLK 40/4X14/EZ-DR/ 200/IB32	2296838	475	FLK 50/EZ-DR/ 250/KONFEK	2289104	536	FLKM S135-470-4UC/U/S400	2314891	541	MACX MCR-EX-SL-NAM-R-SP	2924045	154
FLK 40/4X14/EZ-DR/ 200/OB32	2298522	475	FLK 50/EZ-DR/ 300/KONFEK	2289117	536	FLKM S135/42X0,75/3,0M/OE	2315007	539	MACX MCR-EX-SL-NAM-YO	2905723	160
FLK 40/4X14/EZ-DR/ 300/IB32	2296841	475	FLK 50/EZ-DR/ 300/KONFEK/S	2299136	536	FLKM S135/42X0,75/5,0M/OE	2318017	539	MACX MCR-EX-SL-NAM-YO-SP	2905724	160
FLK 40/4X14/EZ-DR/ 300/OB32	2298535	475	FLK 50/EZ-DR/ 350/KONFEK	2289120	536	FLKM S135/42XMKKSDS	2901603	539	MACX MCR-EX-SL-RPSS-2I-2I	2865382	144
FLK 40/EZ-DR/ 50/KONFEK	2288985	567	FLK 50/EZ-DR/ 400/KONFEK	2289133	536	FLKM S135/S400/SO120	2301723	540	MACX MCR-EX-SL-RPSS-2I-2I-SP	2924676	144
FLK 40/EZ-DR/ 50/SLC	2294610	474	FLK 50/EZ-DR/ 400/KONFEK/S	2299149	536	FLKM S135/S400/SO121	2301736	540	MACX MCR-EX-SL-RPSSI-2I	2865366	143
FLK 40/EZ-DR/ 100/KONFEK	2288998	567	FLK 50/EZ-DR/ 450/KONFEK	2289573	536	FLKM S135/S400/SO125	2301778	541	MACX MCR-EX-SL-RPSSI-2I-1S	2908855	143
FLK 40/EZ-DR/ 100/SLC	2294649	474	FLK 50/EZ-DR/ 500/KONFEK	2289586	536	FLKM S135/S400/SO126	2301781	541	MACX MCR-EX-SL-RPSSI-2I-1S-SP	2908856	143
FLK 40/EZ-DR/ 150/KONFEK	2289007	567	FLK 50/EZ-DR/ 550/KONFEK	2289599	536	FLKM S135/S7/FLK50/PLC	2314736	539	MACX MCR-EX-SL-RPSSI-2I-SP	2924236	143
FLK 40/EZ-DR/ 150/SLC	2294636	474	FLK 50/EZ-DR/ 600/KONFEK	2289609	536	FLKM-1771-WG/OE/21X0,5/0,7M	2910100	547	MACX MCR-EX-SL-RPSSI-H	2865340	142
FLK 40/EZ-DR/ 200/KONFEK	2289010	567	FLK 50/EZ-DR/ 600/KONFEK/S	2299152	536	FLKM-1771-WG/S7-531-7NF/0,5M	2910097	546	MACX MCR-EX-SL-RPSSI-H-SP	2924016	142
FLK 40/EZ-DR/ 200/SLC	2294649	474	FLK 50/EZ-DR/ 650/KONFEK	2289586	536	FLKM-1771-WG/S7-522-5FH/0,5M	2910098	546	MACX MCR-EX-SL-RPSSI-H-UP	2865293	145
FLK 40/EZ-DR/ 250/KONFEK	2289023	567	FLK 50/EZ-DR/ 700/KONFEK	2289625	536	FLKM-1771-WG/SMKDS	2910103	547	MACX MCR-EX-SL-RPSSI-H-UP-SP	2924029	145
FLK 40/EZ-DR/ 300/KONFEK	2289036	567	FLK 50/EZ-DR/ 750/KONFEK	2289638	536	FLKM-1771-WH/OE/21X0,5/0,7M	2910099	547	MACX MCR-EX-SL-SD-21-25-LFD	2905669	164
FLK 40/EZ-DR/ 300/SLC	2294652	474	FLK 50/EZ-DR/ 800/KONFEK	2289641	536	FLKM-1771-WH/S7-521-1BH/0,5M	2910090	546	MACX MCR-EX-SL-SD-21-25-LFD-SP	2905674	164
FLK 40/EZ-DR/ 350/KONFEK	2289049	567	FLK 50/EZ-DR/ 800/KONFEK/S	2299165	536	FLKM-1771-WH/S7-521-1FH/0,5M	2910089	546	MACX MCR-EX-SL-SD-21-25-LP	2865492	166
FLK 40/EZ-DR/ 400/KONFEK	2289052	567	FLK 50/EZ-DR/ 850/KONFEK	2289654	536	FLKM-1771-WH/S7-521-7EH/0,5M	2910092	546	MACX MCR-EX-SL-SD-21-25-LP-SP	2924113	166
FLK 40/EZ-DR/ 600/KONFEK	2299589	567	FLK 50/EZ-DR/ 900/KONFEK	2289667	536	FLKM-1771-WH/S7-522-1BH/0,5M	2910096	546	MACX MCR-EX-SL-SD-21-40-LP	2865764	167
FLK 40/EZ-DR/ 800/KONFEK	2299592	567	FLK 50/EZ-DR/ 950/KONFEK	2289670	536	FLKM-1771-WH/S7-522-5EH/0,5M	2910093	546	MACX MCR-EX-SL-SD-21-40-LP-SP	2924139	167
FLK 40/EZ-DR/1000/KONFEK	2299602	567	FLK 50/EZ-DR/1000/KONFEK	2289683	536	FLKM-1771-WH/S7-522-5FH/0,5M	2910094	546	MACX MCR-EX-SL-SD-21-60-LP	2865515	167
FLK 50-2FLK20-EZ-DR-DV/...	2304966	576	FLK 50/EZ-DR/1000/KONFEK/S	2299178	536	FLKM-1771-WH/S7-522-5HH/0,5M	2910095	546	MACX MCR-EX-SL-SD-21-60-LP-SP	2924100	167
FLK 50-4X14-EZ-DR ...	2302405	437	FLK 50/EZ-DR/D37SUB/ 50/X81-I	2302649	482	FLKM-1771-WH/SMKDS	2910102	547	MACX MCR-EX-SL-SD-23-48-LFD	2924867	167
FLK 50-4X14-EZ-DR-S ...	2302447	537	FLK 50/EZ-DR/D37SUB/ 50/Y81P-O	2302599	482	FLKM-D25 SUB/B/KDS3-MT/TU810	2909894	495	MACX MCR-EX-SL-SD-23-48-LFD-SP	2924870	163
FLK 50-EZ-DR-D37SUB-X81-I/...	2302683	482	FLK 50/EZ-DR/D37SUB/100/X81-I	2302654	482	FLKM-D25 SUB/B/KDS3-MT/TU810P	2295062	507	MACX MCR-EX-SL-SD-24-48-LFD	2906155	165
FLK 50-EZ-DR-D37SUB-Y81P-O/...	2302625	482	FLK 50/EZ-DR/D37SUB/100/Y81P-O	2302609	482	FLKM-D25 SUB/B/KDS3-MT/TU810P	2304513	468	MACX MCR-EX-SL-SD-24-48-LFD-SP	2906156	165
FLK 50-EZ-DR-FCN40-OMR-IN/...	2302803	484	FLK 50/EZ-DR/D37SUB/200/X81-I	2302667	482	FLKM-D25 SUB/B/KDS3-MT/TU830	2304539	468	MACX MCR-EX-SL-SD-24-48-LP	2865690	167
FLK 50-EZ-DR-FCN40-OMR-OUT/...	2302829	484	FLK 50/EZ-DR/D37SUB/200/Y81P-O	2302612	482	FLKM-PA-2D15/HW/DIO/C300	2304526	468	MACX MCR-EX-SL-SD-24-48-LP-SP	2924126	167
FLK 50-PA/EZ-DR/HF/KS/ 100/YUC	2904739	514	FLK 50/EZ-DR/D37SUB/300/X81-I	2302670	482	FLKM-PA-2D15/HW/DIO/C300	2901879	480	MACX MCR-EX-SL-UI-REL	2906164	168
FLK 50-PA/EZ-DR/HF/KS/ 500/YUC	2904740	514	FLK 50/EZ-DR/D37SUB/300/Y81P-O	2302638	482	FLKM-PA-2D15/HW/DIO/C300	2900924	480	MACX MCR-EX-SL-UI-REL-SP	2906165	168
FLK 50-PA/EZ-DR/HF/KS/ 200/YUC	2904741	514	FLK 50/EZ-DR/FCN40/100/OMR-IN	2304160	484	FLKM-PA-D37/ETHA	1076338	512	MACX MCR-EX-T-UI-UP	2865654	150
FLK 50-PA/EZ-DR/HF/KS/ 400/YUC	2904742	514	FLK 50/EZ-DR/FCN40/100/OMR-OUT	2304144	484	FLKM-PA-D37/HW/AN/C300	2900622	480	MACX MCR-EX-T-UI-UP-C	2811763	150
FLK 50-PA/EZ-DR/HF/KS/ 500/YUC	2904636	514	FLK 50/EZ-DR/FCN40/200/OMR-IN	2304173	484	FLKM-PA-D37/HW/DIO/C300	2901423	480	MACX MCR-EX-T-UI-UP-SP	2924689	150
FLK 50-PA/EZ-DR/HF/KS/ 600/YUC	2904743	514	FLK 50/EZ-DR/FCN40/200/OMR-OUT	2304157	484	FLKMS 50/32M/LA/PLC	2284510	522	MACX MCR-EX-T-UI-UP-SP-C	2924692	150
FLK 50-PA/EZ-DR/HF/KS/ 700/YUC	2904744	514	FLK EZ-DR-S.../.../...	2295046	569	FLKMS 50/32M/PLC	2284523	522	MACX MCR-EX-T-UIREL-UP	2865751	152
FLK 50-PA/EZ-DR/HF/KS/ 800/YUC	2904745	514	FLK EZ-DR.../.../...	2295059	569	FUSE-10X38-16A-GR	2903126	37	MACX MCR-EX-T-UIREL-UP-C	2865722	152
FLK 50-PA/EZ-DR/HF/KS/ 900/YUC	2904746	514	FLKM 14-PA-AB/1756/EXTC	2302861	471	FUSE-10X38-20A-GR	2903384	37	MACX MCR-EX-T-UIREL-UP-SP	2924799	152
FLK 50-PA/EZ-DR/HF/KS/1000/YUC	2904637	514	FLKM 14-PA-AB/1756/IN/EXTC	2302874	471	FUSE-10X38-30A-GR	2903119	37	MACX MCR-EX-T-UIREL-UP-SP-C	2924809	152
FLK 50-PA/EZ-DR/HF/KS/1500/YUC	2904638	514	FLKM 14-PA-INLINE/32	2302777	486				MACX MCR-EX-TC-I	1050233	148
FLK 50-PA/EZ-DR/HF/KS/2000/YUC	2904487	514	FLKM 14-PA-INLINE/DIO8	2900889	486				MACX MCR-EX-TC-I-C	1052458	148
FLK 50-PA/EZ-DR/HF/KS/2500/YUC	2904639	514	FLKM 14-PA-INLINE/IN16	2302751	486				MACX MCR-EX-TS-I-OLP	2908660	190
FLK 50-PA/EZ-DR/HF/KS/3000/YUC	2904640	514	FLKM 14-PA-INLINE/OUT16	2302764	486				MACX MCR-EX-TS-I-OLP-SP	2908661	190
FLK 50-PA/EZ-DR/KS/ 100/YUC	2900991	514	FLKM 14-PA-MODI/M340	2903208	490				MACX MCR-PTB	2865625	175
FLK 50-PA/EZ-DR/KS/ 200/YUC	2314299	514	FLKM 14-PA-S300	2299770	503				MACX MCR-PTB-SP	2924184	175
FLK 50-PA/EZ-DR/KS/ 300/YUC	2314309	514	FLKM 14/8M/SI/PLC	2294487	520				MACX MCR-RTD-I	1050192	130
FLK 50-PA/EZ-DR/KS/ 400/YUC	2314312	514	FLKM 14/KDS3-MT/PPA/PLC	2290423	523				MACX MCR-RTD-I-C	1052472	130
FLK 50-PA/EZ-DR/KS/ 500/YUC	2321499	514	FLKM 16/AI/DV	2304429	477				MACX MCR-RTD-I-SP	1050201	130
FLK 50-PA/EZ-DR/KS/ 600/YUC	2314927	514	FLKM 16/AO/SI/DV	2304445	477				MACX MCR-RTD-I-SP-C	1052464	130
FLK 50-PA/EZ-DR/KS/ 700/YUC	2321509	514	FLKM 16/DV	2304432	477	IFS-BT-PROG-ADAPTER	2905872	111	MACX MCR-S-MUX	2865599	172
FLK 50-PA/EZ-DR/KS/ 800/YUC	2314930	514	FLKM 4X14-PA/AN/S7-1500	2907385	493	IFS-CONFSTICK	2986122	434	MACX MCR-S-MUX-TB	2808124	172
FLK 50-PA/EZ-DR/KS/ 900/YUC	2321512	514	FLKM 4X14-PA/PT/DIO/S7-1500	2907382	492	IFS-CONFSTICK-L	2901103	16	MACX MCR-SL-2I-2I-HV-ILP	2907706	125
FLK 50-PA/EZ-DR/KS/1000/YUC	2314325	514	FLKM 4X14-PA/SC/DIO/S7-1500	2907381	492	IFS-USB-DATACABLE	2320500	435	MACX MCR-SL-2I-2I-HV-ILP-SP	2907707	125
FLK 50-PA/EZ-DR/KS/1500/YUC	2314338	514	FLKM 50-PA-AB/1756/EXTC	2302735	470	IFS-USB-PROG-ADAPTER	2811271	111	MACX MCR-SL-2I-2I-ILP	2905280	124
FLK 50-PA/EZ-DR/KS/2000/YUC	2314503	514	FLKM 50-PA-AB/1756/IN/EXTC	2302748	470	ILC 191 ME/AN	2700074	206	MACX MCR-SL-2I-2I-ILP-SP	2907705	125
FLK 50-PA/EZ-DR/KS/2500/YUC	2314516	514	FLKM 50-PA-MODI-TSX/Q	2294306	488	IMC 1,5/ 5-ST-3,81	1857919	16	MACX MCR-SL-2I-2I-ILP-SP	2905281	124
FLK 50-PA/EZ-DR/KS/3000/YUC	2314529	514	FLKM 50-PA-S300	2294445	502	IOA MCR-CJC-PT100	1085776	132	MACX MCR-SL-2NAM-R-UP	2865052	137
FLK 50/2FLK20/EZ-DR/ 50/DV	2304872	476	FLKM 50-PA-S400	2294500	508				MACX MCR-SL-2NAM-R-UP-SP	2924304	137
FLK 50/2FLK20/EZ-DR/ 100/DV	2304898	476	FLKM 50-PA-S400(3-48)	2294908	509				MACX MCR-SL-2NAM-RO		

Index

Alphabetical

Type	Order No.	Page	Type	Order No.	Page	Type	Order No.	Page	Type	Order No.	Page
MACX MCR-SL-NAM-R	2865997	134	MINI MCR-2-F-UI-PT	2902058	86	MINI MCR-2-V8-PB-DP	2905636	100	PACT MCR-V2-5012-85-500-5A-1	2276159	214
MACX MCR-SL-NAM-R-SP	2924252	134	MINI MCR-2-F-UI-PT-C	2902059	86	MINI-PS-100-240AC/24DC/1.5/EX	2866653	108	PACT MCR-V2-5012-85-600-5A-1	2277174	214
MACX MCR-SL-RPSS-2I-2I	2904089	123	MINI MCR-2-FM-RC	2904504	110	MINI-SYS-PS-100-240AC/24DC/1.5	2866983	108	PACT MCR-V2-5012-85-1000-5A-1	2277162	214
MACX MCR-SL-RPSS-2I-2I-SP	2904090	123	MINI MCR-2-FM-RC-PT	2904508	110	MM-CONF-SET	2297992	16	PACT MCR-V2-5012-85-750-5A-1	2276175	214
MACX MCR-SL-RPSSI-2I	2924825	121	MINI MCR-2-I-I	2901998	76	MPS-IH BK	0201731	177	PACT MCR-V2-5012-85-800-5A-1	2277187	214
MACX MCR-SL-RPSSI-2I-SP	2924838	121	MINI MCR-2-I-I-HLP	2901994	80	MPS-IH BU	0201689	177	PACT MCR-V2-5012-85-1000-5A-1	2276463	214
MACX MCR-SL-RPSSI-H	2865955	120	MINI MCR-2-I-I-HLP-PT	2901995	80	MPS-IH GN	0201702	177	PACT MCR-V2-5012-85-600-5A-1	2277190	214
MACX MCR-SL-RPSSI-H-SP	2924207	120	MINI MCR-2-I-I-PT	2901999	76	MPS-IH GY	0201728	177	PACT MCR-V2-5012-85-1250-5A-1	2277200	214
MACX MCR-SL-RPSSI-I-UP	2865968	122	MINI MCR-2-I0-U	2902000	76	MPS-IH RD	0201676	177	PACT MCR-V2-5012-85-1500-5A-1	2276188	214
MACX MCR-SL-RPSSI-I-UP-SP	2924210	122	MINI MCR-2-I0-U-PT	2902001	76	MPS-IH WH	0201663	177	PACT MCR-V2-5012-85-PT	2907416	214
MACX MCR-SL-UI-REL	2906169	140	MINI MCR-2-I4-U	2902002	76	MPS-IH HYE	0201692	177	PACT MCR-V2-5012-85-200-5A-1	2277873	215
MACX MCR-SL-UI-REL-SP	2906170	140	MINI MCR-2-I4-U-PT	2902003	76	MPS-MT	0201744	177	PACT MCR-V2-5012-85-400-5A-1	2277909	215
MACX MCR-T-UI-UP	2811394	128	MINI MCR-2-NAM-2RO	2902004	92				PACT MCR-V2-5012-85-500-5A-1	2277912	215
MACX MCR-T-UI-UP-C	2811873	128	MINI MCR-2-NAM-2RO-PT	2902005	92				PACT MCR-V2-5012-85-600-5A-1	2277925	215
MACX MCR-T-UI-UP-SP	2811860	128	MINI MCR-2-POT-UI	2902016	90				PACT MCR-V2-5012-85-750-5A-1	2277938	215
MACX MCR-T-UI-UP-SP-C	2811970	128	MINI MCR-2-POT-UI-C	2905005	90				PACT MCR-V2-5012-85-800-5A-1	2277941	215
MACX MCR-T-UIREL-UP	2811378	126	MINI MCR-2-POT-UI-PT	2902017	90				PACT MCR-V2-5012-85-1000-5A-1	2277954	215
MACX MCR-T-UIREL-UP-C	2811514	126	MINI MCR-2-POT-UI-PT-C	2905006	90	OPT-5DC/24DC/ 2	2967989	396	PACT MCR-V2-5012-85-1250-5A-1	2277967	215
MACX MCR-T-UIREL-UP-SP	2811828	126	MINI MCR-2-PTB	2902066	109	OPT-5DC/24DC/ 5	2982113	296	PACT MCR-V2-5012-85-PT	2907417	215
MACX MCR-T-UIREL-UP-SP-C	2811831	126	MINI MCR-2-PTB-PT	2902067	109	OPT-5DC/48DC/100	2967992	396	PACT MCR-V3-60	2277417	217
MACX MCR-TC-I	1050228	132	MINI MCR-2-RPS-2I-2I-OLP	2906448	79	OPT-5DC/230AC/ 2	2982168	297			
MACX MCR-TC-I-C	1052459	132	MINI MCR-2-RPS-2I-2I-OLP-PT	2906449	79	OPT-24DC/24DC/ 2	2966595	286	PACT RCP-4000A-1A-D140	2904922	222
MACX MCR-TS-I-OLP	2908662	190	MINI MCR-2-RPS-I-I-OLP	2906446	79	OPT-24DC/24DC/ 5	2982100	296	PACT RCP-4000A-1A-D140-10M	1033485	222
MACX MCR-TS-I-OLP-C	1012249	190	MINI MCR-2-RPS-I-I-OLP-PT	2906447	79	OPT-24DC/48DC/100	2966618	287	PACT RCP-4000A-1A-D140-3M-UV	1058044	224
MACX MCR-TS-I-OLP-SP	2908664	190	MINI MCR-2-RPSS-I-2I	2905628	78	OPT-24DC/230AC/ 1	2967950	287	PACT RCP-4000A-1A-D190	2904923	222
MACX MCR-UI-UP	2811824	116	MINI MCR-2-RPSS-I-2I-PT	2905629	78				PACT RCP-4000A-1A-D190-10M	2910327	222
MACX MCR-UI-UI-NC	2811446	116	MINI MCR-2-RPSS-I-H	2902014	77	OPT-60DC/24DC/ 2	2966605	396	PACT RCP-4000A-1A-D190-3M-UV	1033485	224
MACX MCR-UI-UI-SP	2811572	116	MINI MCR-2-RPSS-I-H-PT	2902015	77	OPT-60DC/48DC/ 5	2982126	296	PACT RCP-4000A-1A-D95	2904921	222
MACX MCR-UI-UI-SP-NC	2811556	116	MINI MCR-2-RTD-UI	2902049	82	OPT-60DC/48DC/100	2966621	396	PACT RCP-4000A-1A-D95-10M	2910326	222
MACX MCR-UI-UI-UP	2811459	118	MINI MCR-2-RTD-UI-C	2902048	82	OPT-60DC/230AC/ 1	2967963	397	PACT RCP-4000A-1A-D95-5M	2910325	222
MACX MCR-UI-UI-UP-NC	2811297	118	MINI MCR-2-RTD-UI-PT	2902052	82				PACT RCP-4000A-UIRO-D140	2906232	223
MACX MCR-UI-UI-UP-SP	2811585	118	MINI MCR-2-RTD-UI-PT-C	2902051	82				PACT RCP-4000A-UIRO-D190	2906233	223
									PACT RCP-4000A-UIRO-D95	2906231	223
MACX MCR-UI-UI-UP-SP-NC	2811569	118	MINI MCR-2-SPS-24-15	1033202	107	PACT MCR-RA	2277598	218	PACT RCP-4000A-UIRO-PT-D140	2906235	223
MACX MCR-VAC	2906239	238	MINI MCR-2-SPS-24-15-PT	1033201	107	PACT MCR-V1-21-44	2277268	211	PACT RCP-4000A-UIRO-PT-D190	2906236	223
MACX MCR-VAC-PT	2906244	238	MINI MCR-2-T-2RO	2906876	97	PACT MCR-V1-21-44-50-5A-1	2277019	211	PACT RCP-4000A-UIRO-PT-D95	2906234	223
MACX MCR-VDC	2906242	238	MINI MCR-2-T-2RO-PT	2906877	97	PACT MCR-V1-21-44-75-5A-1	2277611	211	PACT RCP-CLAMP	2904895	222
MACX MCR-VDC-PT	2906243	238	MINI MCR-2-T-REL	2905632	96	PACT MCR-V1-21-44-100-5A-1	2277022	211	PACT RCP-CLAMP-5-10	2907888	222
MC 1.5/ 5-ST-3,81	1803604	16	MINI MCR-2-T-REL-PT	2905633	96	PACT MCR-V1-21-44-125-5A-1	2277763	211	PACT RCP-D140	2904891	219
MCR-DIN-RAIL-ADAPTER HT	2864671	192	MINI MCR-2-TB	2902068	110	PACT MCR-V1-21-44-150-5A-1	2277035	211	PACT RCP-D140-10M	1033482	219
MCR-PAC-T-USB	2308000	193	MINI MCR-2-TC-UI	2902055	84	PACT MCR-V1-21-44-200-5A-1	2277776	211	PACT RCP-D190	2904892	219
MCR-S-1-5-UI-DCI	2814634	230	MINI MCR-2-TC-UI-C	2902053	84	PACT MCR-V1-21-44-250-5A-1	2277048	211	PACT RCP-D190-10M	2910324	219
MCR-S-1-5-UI-DCI-NC	2814715	230	MINI MCR-2-TC-UI-PT	2905249	84	PACT MCR-V1-21-44-300-5A-1	2277789	211	PACT RCP-D95	2904890	219
MCR-S-1-5-UI-SW-DCI	2814650	230	MINI MCR-2-TC-UI-PT-C	2905248	84	PACT MCR-V1-21-44-400-5A-1	2277051	211	PACT RCP-D95-10M	2910323	219
MCR-S-1-5-UI-SW-DCI-NC	2814731	230	MINI MCR-2-U-I0	2902022	76	PACT MCR-V1-21-44-500-5A-1	2277792	211	PACT RCP-D95-5M	2910322	219
MCR-S-10-50-UI-DCI	2814647	231	MINI MCR-2-U-I0-PT	2902023	76	PACT MCR-V2-3015-60	2277271	212	PACT-FAST-MNT-W13-L40	2276612	218
MCR-S-10-50-UI-SW-DCI	2814663	231	MINI MCR-2-U-I4	2902029	76	PACT MCR-V2-3015-60-150-5A-1	2277077	212	PACT-FAST-MNT-W13-L65	2276625	218
MCR-S-20-100-UI-DCI	2908798	231	MINI MCR-2-U-I4-PT	2902030	76	PACT MCR-V2-3015-60-250-5A-1	2277080	212	PACT-FAST-MNT-W16-L40	2276638	218
MCR-S10-50-UI-DCI-NC	2814728	231	MINI MCR-2-U-U	2902042	76	PACT MCR-V2-3015-60-400-5A-1	2277093	212	PACT-FAST-MNT-W16-L65	2276641	218
MCR-S10-50-UI-SW-DCI-NC	2814744	231	MINI MCR-2-U-U-PT	2902043	76	PACT MCR-V2-4012-70	2277284	213	PLC-2RPT-24DC/1	2901639	404
MCR-SL-CUC-100-I	2308027	229	MINI MCR-2-U-U	2902019	74	PACT MCR-V2-5012-85	2277297	214	PLC-2RSC-24DC/ 1	2987309	404
MCR-SL-CUC-100-U	2308108	228	MINI MCR-2-U-UI-C	2902018	74	PACT MCR-V2-5012-85	2277336	215	PLC-APT-PT100-IN	2906919	403
MCR-SL-CUC-200-I	2308030	229	MINI MCR-2-U-UI-PT	2902021	74	PACT MCR-V2-10020-129	2277378	216	PLC-APT-UI-IN	2906917	432
MCR-SL-CUC-200-U	2308205	228	MINI MCR-2-U-UI-PT-C	2902020	74	PACT MCR-V2-10020-129-2500-5A	2276395	216	PLC-APT-UI-OUT	2906921	433
MCR-SL-CUC-300-I	2308043	229	MINI MCR-2-UI-FRO	2902031	88	PACT MCR-V2-3015-60-60-5A-1	2277815	212	PLC-ATP BK	2966841	426
MCR-SL-CUC-300-U	2308302	228	MINI MCR-2-UI-FRO-C	2906201	88	PACT MCR-V2-3015-60-80-5A-1	2277831	212	PLC-BP A1-14	2980283	426
MCR-SL-CUC-400-I	2308072	229	MINI MCR-2-UI-FRO-PT	2902032	88	PACT MCR-V2-3015-60-100-5A-1	2277064	212	PLC-BPT-24DC/21RW	2900261	418
MCR-SL-CUC-500-I	2308085	229	MINI MCR-2-UI-FRO-PT-C	2906202	88	PACT MCR-V2-3015-60-125-5A-1	2277624	212	PLC-BPT-24UC/ 1/ACT	2900450	379
MCR-SL-CUC-600-I	2308098	229	MINI MCR-2-UI-I-OLP	2902061	81	PACT MCR-V2-3015-60-150-5A-1	2277844	212	PLC-BPT-120UC/ 1/SEN/SO46	2900456	389
MCR-SL-D-FFT	2864024	187	MINI MCR-2-UI-I-OLP-C	2902060	81	PACT MCR-V2-3015-60-200-5A-1	2277637	212	PLC-BSC-120UC/21/SO46	2900453	388
MCR-SL-D-RA	2810081	186	MINI MCR-2-UI-I-OLP-PT	2902063	81	PACT MCR-V2-3015-60-200-5A-1	2277857	212	PLC-BPT-230UC/ 1/SEN/SO46	2900457	389
MCR-SL-D-SPA-UI	2710314	188	MINI MCR-2-UI-I-OLP-PT-C	2902062	81	PACT MCR-V2-3015-60-250-5A-1	2277860	212	PLC-BPT-230UC/21/SO46	2900455	388
MCR-SL-D-U-I	2864011	186	MINI MCR-2-UI-REL	2902033	94	PACT MCR-V2-3015-60-300-5A-1	2277640	212	PLC-BPT-TTL1	2900458	414
MCR-SL-S-16-SP-24	2864464	237	MINI MCR-2-UI-REL-C	2909886	94	PACT MCR-V2-3015-60-500-5A-1	2277653	212	PLC-BSC-24UC/ 1/ACT	2982799	379
MCR-SL-S-100-I-LP	2813486	235	MINI MCR-2-UI-REL-PT	2902035	94	PACT MCR-V2-3015-60-600-5A-1	2277103	212	PLC-BSC-120UC/ 1/SEN/SO46	2980322	389
MCR-SL-S-100-U	2813457	235	MINI MCR-2-UI-REL-PT-C	2909887	94	PACT MCR-V2-3015-60-750-5A-1	2277666	212	PLC-BSC-120UC/21-21/SO46	2980416	389
MCR-SL-S-200-I-LP	2813499	235	MINI MCR-2-UI-UI	2902037	72	PACT MCR-V2-4012-70-500-5A-1	2907413	212	PLC-BSC-120UC/21/SO46	2980319	388
MCR-SL-S-200-U	2813460	235	MINI MCR-2-UI-UI-C	2902036	72	PACT MCR-V2-4012-70-250-5A-1	2277116	213	PLC-BSC-120UC/21HC/SO46	2980432	389
MCR-SLP-1-5-UI-I0	2814359	236	MINI MCR-2-UI-UI-PT	2902040	72	PACT MCR-V2-4012-70-300-5A-1	2277679	213	PLC-BSC-230UC/ 1/SEN/SO46	2980348	389
MCR-TTL-RS232-E	2814388	239	MINI MCR-2-UI-UI-PT-C	2902039	72	PACT MCR-V2-4012-70-400-5A-1					

Type	Order No.	Page	Type	Order No.	Page	Type	Order No.	Page	Type	Order No.	Page
PLC-OPT 5DC/300DC/1	2900381	408	PLC-OSC-120UC/48DC/100/SEN	2966799	381	PLC-RPT-120UC/1AU/MS/SEN	2909679	381	PLC-RSC-48DC/21-21AU	2967280	367
PLC-OPT 12DC/300DC/1	2900382	408	PLC-OSC-120UC/230AC/1	2967879	373	PLC-RPT-120UC/1AU/SEN	2900314	380	PLC-RSC-48DC/21-21AU/MS	2910510	369
PLC-OPT 24DC/24DC/10R	2900398	409	PLC-OSC-125DC/24DC/2	2980050	373	PLC-RPT-120UC/21	2900304	364	PLC-RSC-48DC/21AU	2966126	365
PLC-OPT 24DC/24DC/2	2900364	373	PLC-OSC-125DC/48DC/100	2980047	372	PLC-RPT-120UC/21-21	2900335	366	PLC-RSC-48DC/21HC	2967646	384
PLC-OPT 24DC/24DC/2/ACT	2900376	416	PLC-OSC-125DC/230AC/1	2980063	373	PLC-RPT-120UC/21-21/EX	2909515	386	PLC-RSC-48DC/21HC/MS	2910516	369
PLC-OPT 24DC/24DC/3RW	2900379	417	PLC-OSC-220DC/300DC/1	2980704	408	PLC-RPT-120UC/21-21/MS	2910522	368	PLC-RSC-60DC/21	2966139	364
PLC-OPT 24DC/110DC/3R/W	2900352	372	PLC-OSC-230AC/300DC/1	2980720	408	PLC-RPT-120UC/21-21AU	2900342	367	PLC-RSC-60DC/21-21	2967293	366
PLC-OPT 24DC/48DC/100/SEN	2900358	381	PLC-OSC-230UC/24DC/2	2966663	373	PLC-RPT-120UC/21-21AU/MS	2910528	369	PLC-RSC-60DC/21-21AU	2967303	367
PLC-OPT 24DC/48DC/500W	2900378	409	PLC-OSC-230UC/48DC/100	2966757	372	PLC-RPT-120UC/21/EX	2909529	386	PLC-RSC-60DC/21AU	2966142	365
PLC-OPT 24DC/5DC/100KHZ-G	2902972	413	PLC-OSC-230UC/48DC/100/SEN	2966809	381	PLC-RPT-120UC/21/MS	2909669	365	PLC-RSC-60DC/21HC	2967659	384
PLC-OPT 24DC/110DC/3R/W	2900391	417	PLC-OSC-230UC/230AC/1	2967882	373	PLC-RPT-120UC/21AU	2900310	365	PLC-RSC-120UC/1AU/MS/SEN	2909664	381
PLC-OPT 24DC/230AC/1	2900369	373	PLC-OSC-LPE-24DC/48DC/100	2903171	424	PLC-RPT-120UC/21AU/MS	2909674	365	PLC-RSC-120UC/1AU/SEN	2966320	380
PLC-OPT 24DC/230AC/2.4/ACT	2904632	410	PLC-PT-EIK 1-SVN 24/P	2900397	422	PLC-RPT-120UC/21HC	2900296	384	PLC-RSC-120UC/21	2966197	364
PLC-OPT 24DC/24DC/100KHZ	2902970	412	PLC-PT-ELR W1/ 2-24DC	1069556	423	PLC-RPT-120UC/21HC/EX	2909533	387	PLC-RSC-120UC/21-21	2967086	366
PLC-OPT 24DC/24DC/100KHZ-G	2902974	413	PLC-RPT-12DC/1C/ACT	1078801	382	PLC-RPT-120UC/21HC/MS	2910533	369	PLC-RSC-120UC/21-21/EX	2909511	386
PLC-OPT 24DC/300DC/1	2900383	408	PLC-RPT-12DC/21	2900316	364	PLC-RPT-12DC/21-21/EX	2909513	386	PLC-RSC-120UC/21-21/MS	2910505	368
PLC-OPT 24DC/TTL	2900363	416	PLC-RPT-12DC/21-21	2900329	366	PLC-RPT-12DC/21/EX	2909527	386	PLC-RSC-120UC/21-21AU	2967138	367
PLC-OPT 36DC/110DC/3R/W	2900392	417	PLC-RPT-12DC/21-21AU	2900337	367	PLC-RPT-12DC/21HC/EX	2909531	387	PLC-RSC-120UC/21-21AU/MS	2910511	369
PLC-OPT 48DC/24DC/2	2900365	373	PLC-RPT-12DC/21/MS	2909666	365	PLC-RPT-230AC/21-21/SO46/HI	1079389	392	PLC-RSC-120UC/21/EX	2909525	386
PLC-OPT 48DC/48DC/100	2900353	372	PLC-RPT-12DC/21AU	2900317	365	PLC-RPT-230AC/21HC/SO46/HI	1079404	393	PLC-RSC-120UC/21/MS	2909651	365
PLC-OPT 48DC/110DC/3R/W	2900393	417	PLC-RPT-12DC/21AU/MS	2909671	385	PLC-RPT-230UC/1AU/MS/SEN	2909680	381	PLC-RSC-120UC/21AU	2966281	365
PLC-OPT 48DC/300DC/1	2900390	373	PLC-RPT-12DC/21HC	2900290	364	PLC-RPT-230UC/1AU/SEN	2900315	380	PLC-RSC-120UC/21AU/MS	2909657	365
PLC-OPT 60DC/24DC/2	2900366	373	PLC-RPT-24DC/1/ACT	2900312	374	PLC-RPT-230UC/21	2900305	364	PLC-RSC-120UC/21HC	2967662	384
PLC-OPT 60DC/48DC/100	2900354	372	PLC-RPT-24DC/1/MS/ACT	2909677	375	PLC-RPT-230UC/21-21	2900336	366	PLC-RSC-120UC/21HC/EX	2909520	387
PLC-OPT 60DC/230AC/1	2900371	373	PLC-RPT-24DC/1AU/MS/SEN	2909678	381	PLC-RPT-230UC/21-21/EX	2909516	386	PLC-RSC-120UC/21HC/MS	2910517	369
PLC-OPT 60DC/300DC/1	2900384	408	PLC-RPT-24DC/1AU/SEN	2900313	380	PLC-RPT-230UC/21-21/MS	2910523	368	PLC-RSC-12DC/21-21/EX	2909517	386
PLC-OPT 72DC/110DC/3R/W	2900394	417	PLC-RPT-24DC/1C/ACT	2900298	382	PLC-RPT-230UC/21-21AU	2900343	367	PLC-RSC-12DC/21/EX	2909522	386
PLC-OPT 96DC/110DC/3R/W	2900395	417	PLC-RPT-24DC/1C/ACT	1078683	383	PLC-RPT-230UC/21-21AU/MS	2910529	369	PLC-RSC-12DC/21HC/EX	2909518	387
PLC-OPT-110DC/24DC/3RW	2900380	417	PLC-RPT-24DC/21	2900299	364	PLC-RPT-230UC/21-21AU/RWF	2900345	419	PLC-RSC-230AC/21-21/SO46/HI	1079387	392
PLC-OPT-110DC/110DC/3RW	2900396	417	PLC-RPT-24DC/21-21	2900330	366	PLC-RPT-230UC/21/EX	2909530	386	PLC-RSC-230AC/21HC/SO46/HI	1079402	393
PLC-OPT-110DC/300DC/1	2900385	408	PLC-RPT-24DC/21-21/EX	2909514	386	PLC-RPT-230UC/21/MS	2909670	365	PLC-RSC-230UC/1AU/MS/SEN	2909665	381
PLC-OPT-120AC/300DC/1	2900388	408	PLC-RPT-24DC/21-21/MS	2910519	368	PLC-RPT-230UC/21AU	2900311	365	PLC-RSC-230UC/1AU/SEN	2966333	380
PLC-OPT-120UC/24DC/2	2900367	373	PLC-RPT-24DC/21-21AU	2900338	367	PLC-RPT-230UC/21AU/MS	2909676	365	PLC-RSC-230UC/21	2966207	364
PLC-OPT-120UC/48DC/100	2900355	372	PLC-RPT-24DC/21-21AU/MS	2910524	369	PLC-RPT-230UC/21HC	2900297	384	PLC-RSC-230UC/21-21	2967099	366
PLC-OPT-120UC/48DC/100/SEN	2900359	381	PLC-RPT-24DC/21/MS	2909667	365	PLC-RPT-230UC/21HC/EX	2909534	387	PLC-RSC-230UC/21-21/EX	2909512	386
PLC-OPT-120UC/230AC/1	2900372	373	PLC-RPT-24DC/21AU	2900306	365	PLC-RPT-230UC/21HC/MS	2910534	369	PLC-RSC-230UC/21-21/MS	2910506	368
PLC-OPT-220DC/300DC/1	2900387	408	PLC-RPT-24DC/21AU/MS	2909672	365	PLC-RPT-24DC/21/EX	2909528	386	PLC-RSC-230UC/21-21AU	2967141	367
PLC-OPT-230AC/300DC/1	2900389	408	PLC-RPT-24DC/21HC	2900291	384	PLC-RPT-24DC/21HC/EX	2909532	387	PLC-RSC-230UC/21-21AU/MS	2910513	369
PLC-OPT-230UC/24DC/2	2900368	373	PLC-RPT-24DC/21HC/MS	2910530	369	PLC-RSC-12DC/1C/ACT	1078800	382	PLC-RSC-230UC/21/EX	2909526	386
PLC-OPT-230UC/48DC/100	2900356	372	PLC-RPT-24DC/2X21/FG	2910537	370	PLC-RSC-12DC/21	2966906	364	PLC-RSC-230UC/21/MS	2909653	365
PLC-OPT-230UC/48DC/100/SEN	2900361	381	PLC-RPT-24UC/1/S/H	2900328	406	PLC-RSC-12DC/21-21	2967235	366	PLC-RSC-230UC/21AU	2966294	365
PLC-OPT-230UC/230AC/1	2900374	373	PLC-RPT-24UC/21	2900300	364	PLC-RSC-12DC/21-21AU	2967277	367	PLC-RSC-230UC/21AU/MS	2909660	365
PLC-OPT-LPE-24DC/48DC/100	2903173	424	PLC-RPT-24UC/21-21	2900332	366	PLC-RSC-12DC/21/MS	2909648	365	PLC-RSC-230UC/21HC	2967675	384
PLC-OSC-5DC/5DC/100KHZ-G	2902965	413	PLC-RPT-24UC/21-21/MS	2910520	368	PLC-RSC-12DC/21AU	2966919	365	PLC-RSC-230UC/21HC/EX	2909521	387
PLC-OSC-5DC/24DC/2/ACT	2980144	376	PLC-RPT-24UC/21-21/RW	2900346	421	PLC-RSC-12DC/21AU/MS	2909654	365	PLC-RSC-230UC/21HC/MS	2910518	369
PLC-OSC-5DC/24DC/100KHZ	2902963	412	PLC-RPT-24UC/21-21AU	2900339	367	PLC-RSC-12DC/21HC	2967617	384	PLC-RSC-24DC/21/EX	2909524	386
PLC-OSC-5DC/24DC/100KHZ-G	2902967	413	PLC-RPT-24UC/21-21AU/MS	2910526	369	PLC-RSC-12DC/1-1/ACT	2967109	375	PLC-RSC-24DC/21HC/EX	2909519	387
PLC-OSC-5DC/300DC/1	2980652	408	PLC-RPT-24UC/21-21AU/RW	2900349	421	PLC-RSC-24DC/1/ACT	2966210	374	PLC-SC-EIK 1-SVN 24/P	2982663	422
PLC-OSC-12DC/300DC/1	2980665	408	PLC-RPT-24UC/21/MS	2909668	365	PLC-RSC-24DC/1MS/ACT	2909661	375	PLC-SC-ELR W1/ 2-24DC	2980539	423
PLC-OSC-24DC/5DC/100KHZ-G	2902966	413	PLC-RPT-24UC/21/RW	2900318	420	PLC-RSC-24DC/1AU/MS/SEN	2909663	381	PLC-SC-S/H	2980733	407
PLC-OSC-24DC/24DC/2	2966634	373	PLC-RPT-24UC/21AU	2900307	365	PLC-RSC-24DC/1AU/SEN	2966317	380	PLC-TR-1T-MUL-300M	2910140	262
PLC-OSC-24DC/24DC/2/ACT	2966676	376	PLC-RPT-24UC/21AU/MS	2909673	365	PLC-RSC-24DC/1C/ACT	2967604	382	PLC-TR-1T-MUL-300M-PT	2910141	262
PLC-OSC-24DC/24DC/5/ACT	2982786	409	PLC-RPT-24UC/21AU/RW	2900321	420	PLC-RSC-24DC/1C/ACT	1078680	383	PLC-V8/D15B/IN	2296087	427
PLC-OSC-24DC/24DC/10R	2982702	408	PLC-RPT-24UC/21HC	2900293	384	PLC-RSC-24DC/21	2966171	364	PLC-V8/D15B/OUT	2296041	427
PLC-OSC-24DC/24DC/2/C1D2	5603260	387	PLC-RPT-24UC/21HC/MS	2910531	369	PLC-RSC-24DC/21-21	2967060	366	PLC-V8/D15S/IN	2296074	427
PLC-OSC-24DC/24DC/100KHZ	2902964	412	PLC-RPT-24UC/21HC/RW	2900324	421	PLC-RSC-24DC/21-21/EX	2909509	386	PLC-V8/D15S/OUT	2296058	427
PLC-OSC-24DC/24DC/100KHZ-G	2902968	413	PLC-RPT-24UC/2X21/FG	2910539	370	PLC-RSC-24DC/21-21/MS	2910502	368	PLC-V8/FLK14/IN	2296553	427
PLC-OSC-24DC/48DC/100	2966728	372	PLC-RPT-48DC/21	2900301	364	PLC-RSC-24DC/21-21AU	2967125	367	PLC-V8/FLK14/IN/M	2304115	427
PLC-OSC-24DC/48DC/100/C1D2	5603261	387	PLC-RPT-48DC/21-21	2900333	366	PLC-RSC-24DC/21-21AU/MS	2910507	369	PLC-V8/FLK14/OUT	2295554	427
PLC-OSC-24DC/48DC/100/SEN	2966773	381	PLC-RPT-48DC/21-21/MS	2910521	368	PLC-RSC-24DC/21/MS	2909649	365	PLC-V8/FLK14/OUT/M	2304102	427
PLC-OSC-24DC/48DC/500W	2980636	409	PLC-RPT-48DC/21-21AU	2900340	367	PLC-RSC-24DC/21AU	2966265	365	PLC-V8/CAB/UBUS/0,3M	2905263	435
PLC-OSC-24DC/230AC/1	2967840	373	PLC-RPT-48DC/21-21AU/MS	2910527	369	PLC-RSC-24DC/21AU/MS	2909655	365	PLC-V8/C/PT-24DC/BM2	2907446	431
PLC-OSC-24DC/230AC/1/ACT	2967947	377	PLC-RPT-48DC/21AU	2900308	365	PLC-RSC-24DC/21HC	2967620	384	PLC-V8/C/PT-24DC/EM	2905137	431
PLC-OSC-24DC/230AC/2/ACT	2982760	378	PLC-RPT-48DC/21HC	2900294	384	PLC-RSC-24DC/21HC/MS	2910514	369	PLC-V8/C/PT-24DC/SAM2	2907443	430
PLC-OSC-24DC/230AC/2.4/ACT	2904631	410	PLC-RPT-48DC/21HC/MS	2910532	369	PLC-RSC-24DC/2X21/FG	2910535	370	PLC-V8/FLK14/OUT	2296960	427
PLC-OSC-24DC/300DC/1	2980678	408	PLC-RPT-60DC/21	2900303	364	PLC-RSC-24UC/1/S/H	2982236	406	PLC-V8/FLK14/OUT/M	2304306	427
PLC-OSC-24DC/TTL	2982728	416	PLC-RPT-60DC/21-21	2900334	366	PLC-RSC-24UC/21	2966184	364	PLC-VT	2296870	532
PLC-OSC-48DC/24DC/2	2967002	373	PLC-RPT-60DC/21-21AU	2900341	367	PLC-RSC-24UC/21-21	2967073	366	PLC-VT/ACT	2295567	532
PLC-OSC-48DC/48DC/100	2966993	372	PLC-RPT-60DC/21AU	2900309	365	PL					

Alphabetical

Type	Order No.	Page	Type	Order No.	Page	Type	Order No.	Page	Type	Order No.	Page	
R	REL-IR2/100AC/2X21	2907052	302	REL-MR-110DC/21HC	2961338	290	RIF-0-RSC-24DC/ 1AU	2903364	321	RIF-2-RSC-LV-120AC/2X21	2903322	342
	REL-IR2/200AC/2X21	2907053	302	REL-MR-110DC/21HC AU	2961561	290	RIF-0-RSC-24DC/21	2903374	320	RIF-2-RSC-LV-120AC/4X21	2903317	343
	REL-IR2/24DC/2X21	2907051	302	REL-MR-120AC/21-21AU	2961448	290	RIF-0-RSC-24DC/21AU	2903372	320	RIF-2-RSC-LV-120AC/4X21/EX	2909846	344
	REL-IR2/L- 24AC/2X21	2903666	300	REL-MR-120AC/21-21/MS	2987969	292	RIF-1-BPT/2X21	2900931	288	RIF-2-RSC-LV-230AC/2X21	2903321	342
	REL-IR2/L-120AC/2X21	2903667	300	REL-MR-120AC/21-21AU	2961477	290	RIF-1-BSC/2X21	2900930	289	RIF-2-RSC-LV-230AC/4X21	2903316	343
	REL-IR2/L-230AC/2X21	2903668	300	REL-MR-120AC/21HC	2961419	290	RIF-1-RPT-LDP-12DC/11C	1078802	334	RIF-2-RSC-LV-230AC/4X21/EX	2909847	344
	REL-IR2/LDP- 12DC/2X21	2903659	300	REL-MR-120AC/21HC AU	2961516	290	RIF-1-RPT-LDP-24DC/1X21	2906224	326	RIF-2-RSC-LV-24AC/2X21	2903323	342
	REL-IR2/LDP- 24DC/2X21	2903660	300	REL-MR-120AC/21HC/MS	2987901	292	RIF-1-RPT-LDP-12DC/2X21	2906223	327	RIF-2-RSC-LV-24AC/4X21	2903318	343
	REL-IR2/LDP-110DC/2X21	2903663	300	REL-MR-230AC/21-21	2961451	290	RIF-1-RPT-LDP-24DC/11C	2909884	334	RIF-3-BPT/2X21	2900937	304
	REL-IR2/LDP-125DC/2X21	2903664	300	REL-MR-230AC/21-21/MS	2987972	292	RIF-1-RPT-LDP-24DC/11CT	1078686	336	RIF-3-BPT/3X21	2900938	305
	REL-IR2/LDP-220DC/2X21	2903665	300	REL-MR-230AC/21-21AU	2961480	290	RIF-1-RPT-LDP-24DC/1X21	2903342	326	RIF-3-BSC/2X21	2900935	306
	REL-IR4/100AC/4X21	2907055	302	REL-MR-230AC/21-21AU/MS	2987998	292	RIF-1-RPT-LDP-24DC/1X21AU	2903338	326	RIF-3-BSC/3X21	2900936	307
	REL-IR4/120AC/4X21/EX	2909744	345	REL-MR-230AC/21HC	2961422	290	RIF-1-RPT-LDP-24DC/1X21MS	2905289	330	RIF-3-RPT-LDP-24DC/2X21	2903297	346
	REL-IR4/200AC/4X21	2907056	302	REL-MR-230AC/21HC AU	2961529	290	RIF-1-RPT-LDP-24DC/2X21	2903334	327	RIF-3-RPT-LDP-24DC/3X21	2903294	347
	REL-IR4/230AC/4X21/EX	2909742	345	REL-MR-230AC/21HC AU/MS	2987930	292	RIF-1-RPT-LDP-24DC/2X21/FG	2908215	338	RIF-3-RPT-LV-120AC/2X21	2903296	346
	REL-IR4/24DC/4X21	2907054	302	REL-MR-230AC/21HC/MS	2987914	292	RIF-1-RPT-LDP-24DC/2X21AU	2903330	327	RIF-3-RPT-LV-120AC/3X21	2903293	347
	REL-IR4/24DC/4X21/EX	2909738	345	REL-MR-BL-100AC/21-21/MS	2908183	294	RIF-1-RPT-LDP-24DC/2X21MS	2905291	331	RIF-3-RPT-LV-230AC/2X21	2903295	346
	REL-IR4/L- 24AC/4X21	2903668	300	REL-MR-BL-100AC/21HC/MS	2908179	294	RIF-1-RPT-LV-120AC/1X21	2903340	326	RIF-3-RSC-LV-120AC/3X21	2903292	347
	REL-IR4/L- 24AC/4X21AU	2903683	300	REL-MR-BL-200AC/21-21/MS	2908182	294	RIF-1-RPT-LV-120AC/1X21AU	2903336	326	RIF-3-RSC-LDP-24DC/2X21	2903303	348
	REL-IR4/L-120AC/4X21	2903687	300	REL-MR-BL-200AC/21HC/MS	2908178	294	RIF-1-RPT-LV-120AC/1X21MS	2909776	330	RIF-3-RSC-LDP-24DC/3X21	2903300	349
	REL-IR4/L-120AC/4X21AU	2903684	300	REL-MR-BL-24DC/21-21/MS	2908181	294	RIF-1-RPT-LV-120AC/2X21	2903332	327	RIF-3-RSC-LV-120AC/2X21	2903302	348
	REL-IR4/L-230AC/4X21	2903688	300	REL-MR-BL-24DC/21HC/MS	2908180	294	RIF-1-RPT-LV-120AC/2X21AU	2903328	327	RIF-3-RSC-LV-120AC/3X21	2903299	349
	REL-IR4/L-230AC/4X21AU	2903685	300	REL-MR-G 24/1	2961037	524	RIF-1-RPT-LV-120AC/2X21MS	2909775	331	RIF-3-RSC-LV-230AC/2X21	2903301	348
	REL-IR4/LDP- 12DC/4X21	2903676	300	REL-OR2/L- 24AC/2X21	2903690	308	RIF-1-RPT-LV-230AC/1X21	2903339	326	RIF-3-RSC-LV-230AC/3X21	2903298	349
	REL-IR4/LDP- 24DC/4X21AU	2903689	300	REL-OR2/L-120AC/2X21	2903691	308	RIF-1-RPT-LV-230AC/1X21AU	2903335	326	RIF-4-BPT/3X21	2900961	310
REL-IR4/LDP- 24DC/4X21AU	2903677	300	REL-OR2/L-230AC/2X21	2903692	308	RIF-1-RPT-LV-24AC/1X21	2905290	330	RIF-4-BSC/3X21	2900960	311	
REL-IR4/LDP- 24DC/4X21AU	2903670	300	REL-OR2/LDP- 24DC/2X21	2903689	308	RIF-1-RPT-LV-230AC/2X21	2903331	327	RIF-4-RPT-LDP-24DC/2X21	2903281	350	
REL-IR4/LDP-110DC/4X21	2903680	300	REL-OR2/LDP-220DC/2X21	2907026	308	RIF-1-RPT-LV-230AC/2X21AU	2903327	327	RIF-4-RPT-LDP-24DC/3X1	2903275	352	
REL-IR4/LDP-110DC/4X21AU	2903673	300	REL-OR3/L- 24AC/3X21	2903694	308	RIF-1-RPT-LV-230AC/2X21MS	2905292	331	RIF-4-RPT-LDP-24DC/3X21	2903278	351	
REL-IR4/LDP-125DC/4X21	2903681	300	REL-OR3/L-120AC/3X21	2903695	308	RIF-1-RPT-LV-24AC/1X21	2903341	326	RIF-4-RPT-LV-120AC/2X21	2903280	350	
REL-IR4/LDP-125DC/4X21AU	2903674	300	REL-OR3/L-230AC/3X21	2903696	308	RIF-1-RPT-LV-24AC/1X21AU	2903337	326	RIF-4-RPT-LV-120AC/3X1	2903274	352	
REL-IR4/LDP-220DC/4X21	2903682	300	REL-OR3/LDP-110DC/3X21	2908898	308	RIF-1-RPT-LV-24AC/2X21	2903333	327	RIF-4-RPT-LV-120AC/3X21	2903277	351	
REL-IR4/LDP-220DC/4X21AU	2903675	300	REL-OR3/LDP-125DC/3X21	2909207	308	RIF-1-RPT-LV-24AC/2X21AU	2903329	327	RIF-4-RPT-LV-230AC/2X21	2903279	350	
REL-MR- 4.5DC/21AU	2961370	394	REL-OR3/LDP-220DC/3X21	2907027	308	RIF-1-RSC-LDP-12DC/11C	1078803	334	RIF-4-RPT-LV-230AC/3X1	2903273	352	
REL-MR- 4.5DC/21	2961367	394	REL-OR3/LDP-24DC/3X21	2903693	308	RIF-1-RSC-LDP-12DC/11C	2908500	328	RIF-4-RPT-LV-230AC/3X21	2903276	351	
REL-MR- 12DC/21	2961150	284	REL-OR3/LDP-48DC/3X21	2908897	308	RIF-1-RSC-LDP-12DC/2X21	2908501	329	RIF-4-RSC-LDP-24DC/2X21	2903291	354	
REL-MR- 12DC/21-21	2961257	290	REL-PR1-110DC/1/MB	2908044	314	RIF-1-RSC-LDP-24DC/11C	2909885	334	RIF-4-RSC-LDP-24DC/3X1	2903284	356	
REL-MR- 12DC/21-21/MS	2961299	290	REL-PR1-220DC/1/MB	2908046	314	RIF-1-RSC-LDP-24DC/11CT	1078681	336	RIF-4-RSC-LDP-24DC/3X21	2903288	355	
REL-MR- 12DC/21/AU	2909641	284	REL-PR1-230AC/1/MB	2908047	314	RIF-1-RSC-LDP-24DC/1X21	2903358	328	RIF-4-RSC-LV-120AC/2X21	2903290	354	
REL-MR- 12DC/21AU	2961163	284	REL-PR1-24DC/1/MB	2908040	314	RIF-1-RSC-LDP-24DC/1X21AU	2903354	328	RIF-4-RSC-LV-120AC/3X1	2903283	356	
REL-MR- 12DC/21AU/MS	2909644	284	REL-PR2- 24AC/2X21	2903699	312	RIF-1-RSC-LDP-24DC/1X21MS	2905659	332	RIF-4-RSC-LV-120AC/3X21	2903287	355	
REL-MR- 12DC/21HC	2961309	290	REL-PR2- 24DC/2X21	2903698	312	RIF-1-RSC-LDP-24DC/2X21	2903350	329	RIF-4-RSC-LV-230AC/2X21	2903289	354	
REL-MR- 12DC/21HC AU	2961532	290	REL-PR2-120AC/2X21	2903700	312	RIF-1-RSC-LDP-24DC/2X21/FG	2909848	338	RIF-4-RSC-LV-230AC/3X1	2903282	356	
REL-MR- 18DC/21	2961383	394	REL-PR2-230AC/2X21	2903701	312	RIF-1-RSC-LDP-24DC/2X21AU	2903346	329	RIF-4-RSC-LV-230AC/3X21	2903285	355	
REL-MR- 18DC/21AU	2961493	394	REL-PR3- 24AC/3X1	2903707	314	RIF-1-RSC-LDP-24DC/2X21MS	2905660	333	RIF-BR-12-230 AC	2907060	316	
REL-MR- 24AC/21-21	2961435	290	REL-PR3- 24AC/3X21	2903703	314	RIF-1-RSC-LV-120AC/1X21	2903356	328	RIF-LDM-12-24 DC	2907057	316	
REL-MR- 24AC/21-21/MS	2987956	292	REL-PR3- 24DC/3X1	2903706	314	RIF-1-RSC-LV-120AC/1X21AU	2903352	328	RIF-LDP-110 DC	2900941	316	
REL-MR- 24AC/21-21AU	2961464	290	REL-PR3- 24DC/3X21	2903702	312	RIF-1-RSC-LV-120AC/1X21MS	2909774	332	RIF-LDP-12-24 DC	2900939	316	
REL-MR- 24AC/21HC	2961406	290	REL-PR3-110DC/3X21	2908893	312	RIF-1-RSC-LV-120AC/2X21	2903348	329	RIF-LDP-48-60 DC	2900940	316	
REL-MR- 24AC/21HC AU	2961503	290	REL-PR3-120AC/3X1	2903708	314	RIF-1-RSC-LV-120AC/2X21AU	2903344	329	RIF-LV-12-24 UC	2900942	316	
REL-MR- 24AC/21HC/MS	2987891	292	REL-PR3-120AC/3X21	2903704	312	RIF-1-RSC-LV-120AC/2X21MS	2909773	333	RIF-LV-120-230 AC/110 DC	2900944	316	
REL-MR- 24DC/11C	2961341	395	REL-PR3-220DC/3X21	2909055	312	RIF-1-RSC-LV-230AC/1X21	2903355	328	RIF-LV-48-60 UC	2900943	316	
REL-MR- 24DC/21	2961105	284	REL-PR3-230AC/3X1	2903709	314	RIF-1-RSC-LV-230AC/1X21AU	2903351	328	RIF-LVM-100-200 AC/110 DC	2907058	316	
REL-MR- 24DC/21-21	2961192	290	REL-PR3-230AC/3X21	2903705	312	RIF-1-RSC-LV-230AC/1X21MS	2905661	332	RIF-RC-12-24 UC	2900949	316	
REL-MR- 24DC/21-21/MS	2987943	292	REL-SR- 24DC/2X21/FG	2908777	339	RIF-1-RSC-LV-230AC/2X21AU	2903347	329	RIF-RC-120-230 UC	2900951	316	
REL-MR- 24DC/21-21AU	2961215	290	RIF-0-BPT-M/ 21	2907468	282	RIF-1-RSC-LV-230AC/2X21MS	2903343	329	RIF-RC-48-60 UC	2900950	316	
REL-MR- 24DC/21AU/MS	2987985	292	RIF-0-BPT/1	2901873	283	RIF-1-RSC-LV-230AC/2X21MS	2905662	333	RIF-RH-1	2900953	289	
REL-MR- 24DC/21/MS	2909642	284	RIF-0-BPT/21	2900958	282	RIF-1-RSC-LV-24AC/1X21	2903357	328	RIF-RH-1-H	2904468	289	
REL-MR- 24DC/21AU	2961121	284	RIF-0-BSC/1	2901872	283	RIF-1-RSC-LV-24AC/1X21AU	2903353	328	RIF-RH-2	2900954	289	
REL-MR- 24DC/21AU/MS	2909645	284	RIF-0-BSC/21	2900957	283	RIF-1-RSC-LV-24AC/2X21	2903349	329	RIF-RH-3	2900955	305	
REL-MR- 24DC/21HC	2961312	290	RIF-0-OSC-24DC/230AC/1	2905295	323	RIF-1-RSC-LV-24AC/2X21AU	2903345	329	RIF-RH-4	2900956	311	
REL-MR- 24DC/21HC AU	2961545	290	RIF-0-OSC-24DC/24DC/2	2905293	323	RIF-1-V8/PTI/FLK14/OUT	2905195	359	RIF-RHM-1	2905986	289	
REL-MR- 24DC/21HC AU/MS	2987927	292	RIF-0-OSC-24DC/48DC/100	2905294	323	RIF-2-BPT/4X21	2900934	298	RIF-RHM-1-H	2905985	289	
REL-MR- 24DC/21HC/MS	2987888	292	RIF-0-OSC-24DC/230AC/1	2905656	325	RIF-2-BSC/4X21	2900932	299	RIF-RHM-2	2905984	299	
REL-MR- 48DC/21-21	2834834	290	RIF-0-OSC-24DC/24DC/2	2905657	324	RIF-2-RPT-LDP-24DC/2X21	2903315	340	RIF-RHM-4	2905983	311	
REL-MR- 48DC/21-21AU	2834847	290	RIF-0-OSC-24DC/48DC/100	2905658	325	RIF-2-RPT-LDP-24DC/4X21	2903308	341	RIF-RHS-2	2908043	299	
REL-MR- 48DC/21HC	2834821	290	RIF-0-RPT-12DC/ 1	2903362	319	RIF-2-RPT-LDP-24DC/4X21/EX	2909741	344	RIF-T3-24UC	2902647	258	
REL-MR- 60DC/21	2961118	394	RIF-0-RPT-12DC/ 1AU	2903360	319	RIF-2-RPT-LV-120AC/2X21	2903311	340	RIF-V-12-24 UC	2900945	316	
REL-MR- 60DC/21-21	2961273	290	RIF-0-RPT-12DC/21	2903371	318	RIF-2-RPT-LV-120AC/4X21	2903305	341	RIF-V-120-230			

Type	Order No.	Page	Type	Order No.	Page	Type	Order No.	Page	Type	Order No.	Page
SD FLASH 2GB EMLOG	2403484	206	VIP-2/SC/2FLK14 (1-20) /S7	2315230	507	VIP-3/SC/HD62SUB/F	2322430	558	VIP-PA-PWR/4X10 PT/ 4,0M/S7	2905522	496
SK 5,0 WH:REEL	0805221	111	VIP-2/SC/2FLK14/AB-1756	2322333	473	VIP-3/SC/HD62SUB/M	2322391	558	VIP-PA-PWR/4X10 PT/10,0M/S7	2905526	496
SSA 3-6	2839295	173	VIP-2/SC/D 9SUB/F	2315162	552	VIP-3/SC/RJ45	2900701	559	VIP-PA-PWR/4X10COMBI/ 1,0M/S7	2904703	496
SSA 5-10	2839512	173	VIP-2/SC/D 9SUB/M	2315117	552	VIP-8RPT-120AC/1AU/DI/PLC	2904576	526	VIP-PA-PWR/4X10COMBI/ 1,5M/S7	2904704	496
ST-OV3- 24DC/400AC/3	2905417	450	VIP-2/SC/D15SUB/F	2315175	552	VIP-8RPT-24DC/1AU/DI/PLC	2903600	526	VIP-PA-PWR/4X10COMBI/ 2,0M/S7	2904705	496
ST-REL3-KG 24/ 1/SO38	2829564	448	VIP-2/SC/D15SUB/M	2315120	552	VIP-8RPT-24DC/21/DO/FU/PLC	2903601	525	VIP-PA-PWR/4X10COMBI/ 2,5M/S7	2904706	496
ST-REL3-KG 24/21/AU/SO46	2826981	446	VIP-2/SC/D37SUB/M	2900676	481	VIP-CAB-FLK14/AXIO/0, 14/0,5M	2901604	485	VIP-PA-PWR/4X10COMBI/ 3,0M/S7	2904707	496
ST-REL3-KG 24/21/SO46	2826091	446	VIP-2/SC/D37SUB/M/SO	2900786	481	VIP-CAB-FLK14/AXIO/0, 14/1,0M	2901605	485	VIP-PA-PWR/4X10COMBI/ 4,0M/S7	2904708	496
ST-REL3-KG120/21/AU/SO46	2829797	446	VIP-2/SC/FLK10	2315010	548	VIP-CAB-FLK14/AXIO/0, 14/1,5M	2901606	485	VIP-PA-PWR/4X10COMBI/10,0M/S7	2904712	496
ST-REL3-KG120/21/SO46	2833026	446	VIP-2/SC/FLK14	2315023	548	VIP-CAB-FLK14/AXIO/0, 14/2,0M	2901607	485	VIP-PT/FLK16/DS/FU/LED/AN/DV	2903599	479
ST-REL3-KG230/21/AU/SO46	2826266	446	VIP-2/SC/FLK14/8M/PLC	2322281	518	VIP-CAB-FLK14/AXIO/0, 14/2,5M	2901608	485			
ST-REL3-KG230/21/SO46	2832027	446	VIP-2/SC/FLK14/8P/PLC	2322294	518	VIP-CAB-FLK14/AXIO/0, 14/3,0M	2901609	485			
STP 5-2	0800967	358	VIP-2/SC/FLK14/LED/PLC	2322249	516	VIP-CAB-FLK14/AXIO/0, 14/4,0M	2901610	485			
SZF 1-0,6X3,5	1204517	426	VIP-2/SC/FLK14/PLC	2315214	516	VIP-CAB-FLK14/AXIO/0, 14/6,0M	2901611	485			
			VIP-2/SC/FLK16	2315036	548	VIP-PA-FLK14-S7/...	2900887	501			
			VIP-2/SC/FLK20	2315049	548	VIP-PA-FLK14/ 0,5M/S7	2322663	501			
			VIP-2/SC/FLK50 (1-40) /S7	2315243	506	VIP-PA-FLK14/ 1,0M/S7	2322676	501	ZB 15:UNBEDRUCKT	0811972	358
			VIP-2/SC/FLK50/AB-1756	2322317	472	VIP-PA-FLK14/ 1,5M/S7	2322689	501	ZB 5 :UNBEDRUCKT	1050004	358
			VIP-2/SC/FLK50/LED/PLC	2322252	517	VIP-PA-FLK14/ 2,0M/S7	2321790	501	ZB 6,LGS:FORTL.ZAHLEN	1051016	426
			VIP-2/SC/FLK50/MODI-TSX/Q	2322304	489	VIP-PA-FLK14/ 2,5M/S7	2322692	501	ZB 6:UNBEDRUCKT	1051003	358
			VIP-2/SC/FLK50/PLC	2315227	517	VIP-PA-FLK14/ 3,0M/S7	2322702	501			
			VIP-2/SC/FLK50/S7/A-S400	2322359	510	VIP-PA-FLK14/ 4,0M/S7	2322715	501			
			VIP-2/SC/HD15SUB/F	2322401	558	VIP-PA-FLK14/10,0M/S7	2322760	501			
			VIP-2/SC/PDM-2/16	2315256	578	VIP-PA-FLK50-4X14-S7/...	2900886	501			
			VIP-2/SC/PDM-2/24	2315269	578	VIP-PA-FLK50-S7/...	2900885	500			
			VIP-2/SC/PDM-2/32	2315272	578	VIP-PA-FLK50/ 0,5M/S7	2322443	500			
			VIP-2/SC/PDM-2/48	2903717	578	VIP-PA-FLK50/ 1,0M/S7	2322456	500			
			VIP-3/PT/2FLK14/AN/2P/S7-1500A	2908465	495	VIP-PA-FLK50/ 1,5M/S7	2322469	500			
			VIP-3/PT/2FLK14/AN/2P/S7-1500B	2908846	495	VIP-PA-FLK50/ 2,0M/S7	2321800	500			
			VIP-3/PT/D25SUB/F	2903782	555	VIP-PA-FLK50/ 2,5M/S7	2322472	500			
			VIP-3/PT/D25SUB/M	2903781	555	VIP-PA-FLK50/ 3,0M/S7	2322485	500			
			VIP-3/PT/D37SUB/F	2903784	555	VIP-PA-FLK50/ 4,0M/S7	2322498	500			
			VIP-3/PT/D37SUB/M	2903783	555	VIP-PA-FLK50/10,0M/S7	2322540	500			
			VIP-3/PT/D37SUB/M/HW/C300	2904276	481	VIP-PA-FLK50/4X14/ 0,5M/S7	2322553	501			
			VIP-3/PT/D50SUB/F	2903786	555	VIP-PA-FLK50/4X14/ 1,0M/S7	2322566	501			
			VIP-3/PT/D50SUB/M	2903785	555	VIP-PA-FLK50/4X14/ 1,5M/S7	2322579	501			
			VIP-3/PT/FLK14/8IM/LED/PLC	2904281	521	VIP-PA-FLK50/4X14/ 2,0M/S7	2321910	501			
			VIP-3/PT/FLK14/8IM/PLC	2904282	521	VIP-PA-FLK50/4X14/ 2,5M/S7	2322582	501			
			VIP-3/PT/FLK26	2903791	551	VIP-PA-FLK50/4X14/ 3,0M/S7	2322595	501			
			VIP-3/PT/FLK34	2903792	551	VIP-PA-FLK50/4X14/ 4,0M/S7	2322605	501			
			VIP-3/PT/FLK40	2903793	551	VIP-PA-FLK50/4X14/10,0M/S7	2322650	501			
			VIP-3/PT/FLK50	2903794	551	VIP-PA-PWR/20XOE/ 1,0M/S7	2904724	499			
			VIP-3/PT/FLK50/AN/2P/S7-1500	2908499	494	VIP-PA-PWR/20XOE/ 2,0M/S7	2904725	499			
			VIP-3/PT/FLK50/AN/S7-1500	2908496	494	VIP-PA-PWR/20XOE/ 3,0M/S7	2904726	499			
			VIP-3/PT/FLK60	2903795	551	VIP-PA-PWR/20XOE/ 4,0M/S7	2904727	499			
			VIP-3/PT/FLK64	2903796	551	VIP-PA-PWR/20XOE/10,0M/S7	2904730	499			
			VIP-3/PT/HD26SUB/F	2904273	558	VIP-PA-PWR/20XOE/HF/ 1,0M/S7	2908916	499			
			VIP-3/PT/HD26SUB/M	2904269	558	VIP-PA-PWR/20XOE/HF/ 2,0M/S7	2908915	499			
			VIP-3/PT/HD44SUB/F	2904274	558	VIP-PA-PWR/20XOE/HF/ 3,0M/S7	2908914	499			
			VIP-3/PT/HD44SUB/M	2904270	558	VIP-PA-PWR/20XOE/HF/ 4,0M/S7	2908913	499			
			VIP-3/PT/HD62SUB/F	2904275	558	VIP-PA-PWR/20XOE/HF/10,0M/S7	2908910	499			
			VIP-3/PT/HD62SUB/M	2904271	558	VIP-PA-PWR/2X10 PT/ 1,0M/S7	2905529	497			
			VIP-3/PT/PDM-2/16	2903797	579	VIP-PA-PWR/2X10 PT/ 1,5M/S7	2905531	497			
			VIP-3/PT/PDM-2/24	2903798	579	VIP-PA-PWR/2X10 PT/ 2,0M/S7	2905532	497			
			VIP-3/PT/PDM-2/32	2903799	579	VIP-PA-PWR/2X10 PT/ 2,5M/S7	2905533	497			
			VIP-3/PT/PDM-2/48	2903800	579	VIP-PA-PWR/2X10 PT/ 3,0M/S7	2905534	497			
			VIP-3/PT/RJ45	2904290	559	VIP-PA-PWR/2X10 PT/ 4,0M/S7	2905535	497			
			VIP-3/SC/2FLK14/AN/2P/S7-1500A	2908464	495	VIP-PA-PWR/2X10 PT/10,0M/S7	2905539	497			
			VIP-3/SC/2FLK14/AN/2P/S7-1500B	2908845	495	VIP-PA-PWR/2X10COMBI/ 1,0M/S7	2904714	497			
			VIP-3/SC/D25SUB/F	2315188	553	VIP-PA-PWR/2X10COMBI/ 1,5M/S7	2904715	497			
			VIP-3/SC/D25SUB/M	2315133	553	VIP-PA-PWR/2X10COMBI/ 2,0M/S7	2904716	497			
			VIP-3/SC/D37SUB/F	2315191	553	VIP-PA-PWR/2X10COMBI/ 2,5M/S7	2904717	497			
			VIP-3/SC/D37SUB/M	2315146	553	VIP-PA-PWR/2X10COMBI/ 3,0M/S7	2904718	497			
			VIP-3/SC/D37SUB/M/HW/C300	2900675	481	VIP-PA-PWR/2X10COMBI/ 4,0M/S7	2904719	497			
			VIP-3/SC/D50SUB/F	2315201	553	VIP-PA-PWR/2X10COMBI/10,0M/S7	2904723	497			
			VIP-3/SC/D50SUB/M	2315159	553	VIP-PA-PWR/40XOE/ 1,0M/S7	2904731	498			
			VIP-3/SC/FLK14/8IM/LED/PLC	2322265	521	VIP-PA-PWR/40XOE/ 2,0M/S7	2904732	498			
			VIP-3/SC/FLK14/8IM/PLC	2322278	521	VIP-PA-PWR/40XOE/ 3,0M/S7	2904733	498			
			VIP-3/SC/FLK26	2315052	549	VIP-PA-PWR/40XOE/ 4,0M/S7	2904734	498			
			VIP-3/SC/FLK34	2315065	549	VIP-PA-PWR/40XOE/10,0M/S7	2904737	498			
			VIP-3/SC/FLK40	2315078	549	VIP-PA-PWR/40XOE/HF/ 1,0M/S7	2908909	499			
			VIP-3/SC/FLK50	2315081	549	VIP-PA-PWR/40XOE/HF/ 2,0M/S7	2908908	499			
			VIP-3/SC/FLK50/AN/2P/S7-1500	2908497	494	VIP-PA-PWR/40XOE/HF/ 3,0M/S7	2908907	499			
			VIP-3/SC/FLK50/AN/S7-1500	2908495	494	VIP-PA-PWR/40XOE/HF/ 4,0M/S7	2908905	499			
			VIP-3/SC/FLK60	2315094	549	VIP-PA-PWR/40XOE/HF/10,0M/S7	2908902	499			
			VIP-3/SC/FLK64	2315104	549	VIP-PA-PWR/4X10 PT/ 1,0M/S7	2905517	496			
			VIP-3/SC/HD26SUB/F	2322414	558	VIP-PA-PWR/4X10 PT/ 1,5M/S7	2905518	496			
			VIP-3/SC/HD26SUB/M	2322375	558	VIP-PA-PWR/4X10 PT/ 2,0M/S7	2905519	496			
			VIP-3/SC/HD44SUB/F	2322427	558	VIP-PA-PWR/4X10 PT/ 2,5M/S7	2905520	496			
			VIP-3/SC/HD44SUB/M	2322388	558	VIP-PA-PWR/4X10 PT/ 3,0M/S7	2905521	496			

Z

ZB 15:UNBEDRUCKT	0811972	358
ZB 5 :UNBEDRUCKT	1050004	358
ZB 6,LGS:FORTL.ZAHLEN	1051016	426
ZB 6:UNBEDRUCKT	1051003	358

For up-to-date modifications or supplements
to the catalog contents, please visit:
phoenixcontact.net/webcode/#0132

