OUTPUT CAPACITOR-LESS/LOW VOLTAGE 200mA LDO REGULATOR

NO.EA-181-170424

OUTLINE

The RP107x Series are CMOS-based LDO regulators featuring 200mA output.

Since the output capacitor and noise bypass capacitor are able to be reduced and the packages are small DFN(PLP)1212-6, WLCSP-4-P5, and SC-88A, high density mounting on boards are possible. The input voltage (V_{IN}) is as low as Min.1.4V and the output voltage can be set from 1.0V.

Supply current is as low as 9.5 μ A compared to existing lines. The CE pin can switch the regulator to standby mode.

FEATURES

- Supply Current Typ. 9.5 μ A
- Standby Mode Typ. 0.1 μ A
- Dropout Voltage..... Typ. 0.27V ($I_{OUT}=200\text{mA}$, $V_{OUT}=3.0\text{V}$)
- Ripple Rejection Typ. 70dB ($f=1\text{kHz}$, $V_{OUT}\leq 1.2\text{V}$)
Typ. 65dB ($f=1\text{kHz}$, $1.2\text{V}<V_{OUT}<2.2\text{V}$)
Typ. 60dB ($f=1\text{kHz}$, $V_{OUT}\geq 2.2\text{V}$)
- Temperature-Drift Coefficient of Output Voltage Typ. $\pm 100\text{ppm}/^\circ\text{C}$
- Line Regulation Typ. 0.02%/V
- Output Voltage Accuracy $\pm 1.0\%$
- Packages..... WLCSP-4-P5, DFN(PLP)1212-6, SC-88A, SOT-23-5
- Input Voltage Range..... 1.4V to 5.25V
- Output Voltage Range 1.0V to 4.2V (0.1V steps)
(For other voltages, please refer to MARK INFORMATIONS.)
- Built-in Fold Back Protection Circuit..... Typ. 50mA (Current at short mode)
- Output capacitor free and noise bypass capacitor free

APPLICATIONS

- Power source for portable communication equipment.
- Power source for electrical appliances such as cameras, VCRs and camcorders.
- Power source for battery-powered equipment.
- Power source for home appliances.

RP107x

NO.EA-181-170424

BLOCK DIAGRAMS

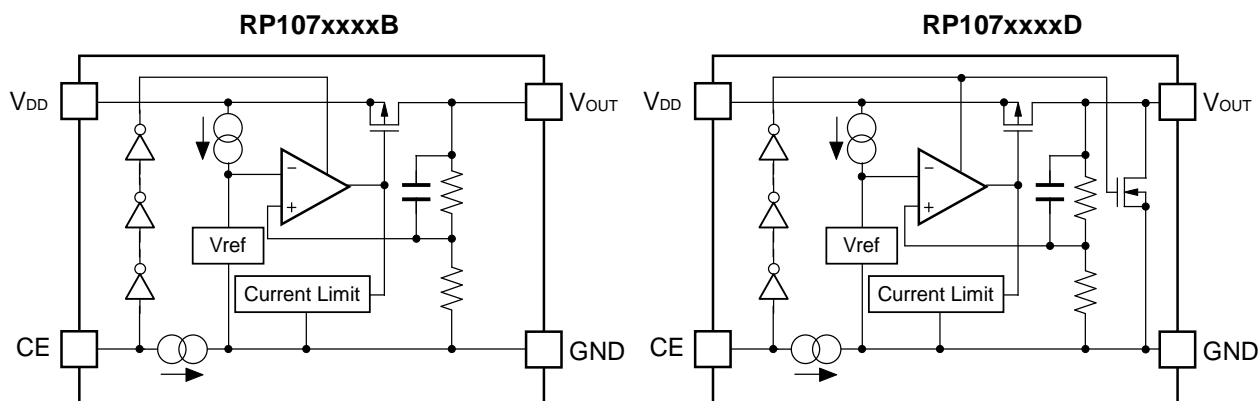

SELECTION GUIDE

The output voltage, auto discharge function, package, and the taping type, etc. for the ICs can be selected at the user's request.

Product Name	Package	Quantity per Reel	Pb Free	Halogen Free
RP107Zxx1*(y)-TR-F	WLCSP-4-P5	5,000 pcs	Yes	Yes
RP107Kxx1*(y)-TR	DFN(PLP)1212-6	5,000 pcs	Yes	Yes
RP107Qxx2*(y)-TR-FE	SC-88A	3,000 pcs	Yes	Yes
RP107Nxx1*(y)-TR-FE	SOT-23-5	3,000 pcs	Yes	Yes

xx: The output voltage (V_{OUT}) can be designated in the range from 1.0V to 4.2V in 0.1V steps.

(y): If the output voltage includes the 3rd digit, indicate the digit of 0.01V.

1.25V: RP107x12x*5

1.85V: RP107x18x*5

2.85V: RP107x28x*5

*: Select (B) without auto-discharge function or (D) with auto-discharge function.

*1 Auto-discharge function quickly lowers the output voltage to 0V by releasing the electrical charge accumulated in the external capacitor when the chip enable signal is switched from the active mode to the standby mode.

PIN CONFIGURATIONS

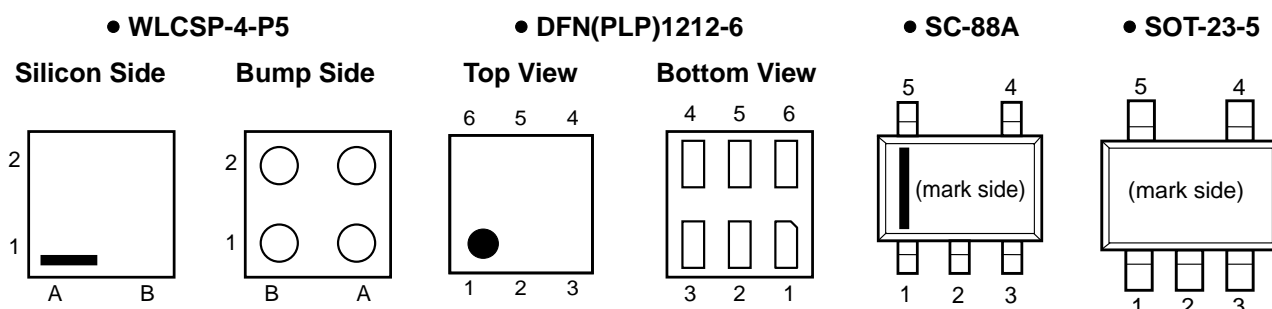

PIN DESCRIPTIONS

• WLCSP-4-P5

Pin No	Symbol	Pin Description
A1	V _{DD}	Input Pin
A2	V _{OUT}	Output Pin
B1	CE	Chip Enable Pin
B2	GND	Ground Pin

• DFN(PLP)1212-6

Pin No	Symbol	Pin Description
1	NC	No Connection
2	GND	Ground Pin
3	CE	Chip Enable Pin
4	V _{DD}	Input Pin
5	NC	No Connection
6	V _{OUT}	Output Pin

• SC-88A

Pin No	Symbol	Pin Description
1	CE	Chip Enable Pin
2*	NC	No Connection
3	GND	Ground Pin
4	V _{OUT}	Output Pin
5	V _{DD}	Input Pin

* Pin No. 2 is connected to the bottom of the IC. It is recommended that the pin be connected to the ground plane on the board, or otherwise be left floating so that there is no contact with other potentials.

*RP107N (SOT-23-5) is the Discontinued product. As of March in 2019.

RP107x

NO.EA-181-170424

• SOT-23-5

Pin No	Symbol	Pin Description
1	V _{DD}	Input Pin
2	GND	Ground Pin
3	CE	Chip Enable Pin
4	NC	No Connection
5	V _{OUT}	Output Pin

ABSOLUTE MAXIMUM RATINGS

Symbol	Item	Rating	Unit
V _{IN}	Input Voltage	6.0	V
V _{CE}	Input Voltage (CE Pin)	-0.3 to 6.0	V
V _{OUT}	Output Voltage	-0.3 to V _{IN} +0.3	V
I _{OUT}	Output Current	400	mA
P _D	Power Dissipation* (WLCSP-4-P5)	278	mW
	Power Dissipation* (DFN(PLP)1212-6)	400	
	Power Dissipation* (SC-88A)	380	
	Power Dissipation* (SOT-23-5)	420	
T _{opt}	Operating Temperature Range	-40 to 85	°C
T _{stg}	Storage Temperature Range	-55 to 125	°C

*) For Power Dissipation, please refer to PACKAGE INFORMATION.

ABSOLUTE MAXIMUM RATINGS

Electronic and mechanical stress momentarily exceeded absolute maximum ratings may cause the permanent damages and may degrade the life time and safety for both device and system using the device in the field.

The functional operation at or over these absolute maximum ratings is not assured.

ELECTRICAL CHARACTERISTICS

• RP107xxxxB/D

$V_{IN} = V_{SET}^{*3} + 1.0V$, $I_{OUT} = 1mA$, $C_{IN} = C_{OUT} = 0.1\mu F$, unless otherwise noted.

The specifications surrounded by are guaranteed by Design Engineering at $-40^{\circ}C \leq T_a \leq 85^{\circ}C$.

RP107x Series

($T_a = 25^{\circ}C$)

Symbol	Item	Conditions	Min.	Typ.	Max.	Unit	
V_{OUT}	Output Voltage	$T_a = 25^{\circ}C$	$V_{SET} > 2.0V$	x 0.990		x 1.010	V
			$V_{SET} \leq 2.0V$	-20		+20	mV
		$-40^{\circ}C \leq T_a \leq 85^{\circ}C$	$V_{SET} > 2.0V$	x 0.980		x 1.015	V
			$V_{SET} \leq 2.0V$	-40		+30	mV
I_{OUT}	Output Current		200			mA	
$\frac{\Delta V_{OUT}}{\Delta I_{OUT}}$	Load Regulation	$1mA \leq I_{OUT} \leq 200mA$		25	50	mV	
V_{DIF}	Dropout Voltage	Refer to <i>Dropout Voltage Specifications</i> .					
I_{SS}	Supply Current ($I_{OUT}=0mA$)	$I_{OUT} = 0mA$		9.5	25	μA	
$I_{standby}$	Standby Current	$V_{CE} = GND$		0.1	3.0	μA	
$\frac{\Delta V_{OUT}}{\Delta V_{IN}}$	Line Regulation	$V_{SET} + 0.5V \leq V_{IN} \leq 5V$ $I_{OUT} = 1mA$		± 0.02	±0.20	%/V	
RR	Ripple Rejection	$f = 1kHz (V_{OUT} \leq 1.2V)$ $f = 1kHz (1.2V < V_{OUT} < 2.2V)$ $f = 1kHz (V_{OUT} \leq 2.2V)$ Ripple 0.2Vp-p $V_{IN} = V_{SET} + 1.0V$ $I_{OUT} = 30mA$ Note: When $V_{OUT} \leq 1.2V$, $V_{IN} = 2.2V$.		70 65 60		dB	
V_{IN}	Input Voltage		1.4		5.25	V	
$\frac{\Delta V_{OUT}}{\Delta T_a}$	Output Voltage Temperature Coefficient	$-40^{\circ}C \leq T_a \leq 85^{\circ}C$		± 100		ppm/ $^{\circ}C$	
I_{SC}	Short Current Limit	$V_{OUT} = 0V$		50		mA	
I_{CEPD}	CE Pull-down Current			0.1		μA	
V_{CEH}	CE Input Voltage "H"		1.0			V	
V_{CEL}	CE Input Voltage "L"				0.4	V	
R_{LOW}	Auto-discharge Nch ON Resistance (D version only)	$V_{IN} = 4.0V$ $V_{CE} = 0V$		30		Ω	

All test items listed under [7] *Electrical Characteristics* are done under the pulse load condition ($T_j \approx T_a = 25^{\circ}C$) except for Ripple Rejection and Output Voltage Temperature Coefficient.

*3 V_{SET} = Set Output Voltage

*RP107N (SOT-23-5) is the Discontinued product. As of March in 2019.

RP107x

NO.EA-181-170424

The specifications surrounded by are guaranteed by Design Engineering at $-40^{\circ}\text{C} \leq T_a \leq 85^{\circ}\text{C}$.

Dropout Voltage Specifications

($t_a=25^{\circ}\text{C}$)

Output Voltage V_{SET} (V)	Dropout Voltage V_{DIF} (V)	
	Condition	Typ. Max.
$1.0 \leq V_{\text{SET}} < 1.1$	$I_{\text{OUT}} = 200\text{mA}$	0.64 0.92
$1.1 \leq V_{\text{SET}} < 1.2$		0.59 0.84
$1.2 \leq V_{\text{SET}} < 1.5$		0.55 0.76
$1.5 \leq V_{\text{SET}} < 2.0$		0.44 0.60
$2.0 \leq V_{\text{SET}} < 2.6$		0.35 0.49
$2.6 \leq V_{\text{SET}}$		0.27 0.36

RECOMMENDED OPERATING CONDITIONS (ELECTRICAL CHARACTERISTICS)

All of electronic equipment should be designed that the mounted semiconductor devices operate within the recommended operating conditions. The semiconductor devices cannot operate normally over the recommended operating conditions, even if when they are used over such conditions by momentary electronic noise or surge. And the semiconductor devices may receive serious damage when they continue to operate over the recommended operating conditions.

TYPICAL APPLICATION

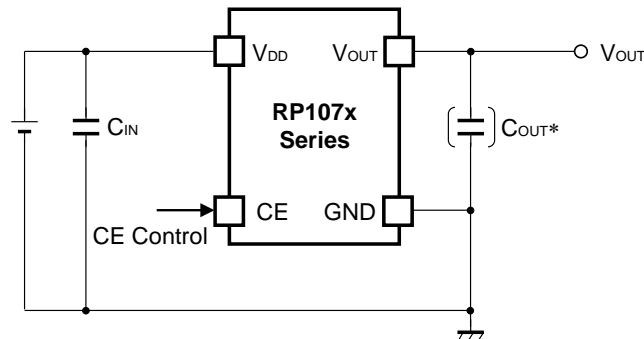

TECHNICAL NOTES

When using the RP107x Series, please note the following points.

*Phase Compensation

The RP107x Series are using an output capacitor as phase compensation to ensure a stable operation even if the output load fluctuates. To reduce the output voltage fluctuation, it is imperative that a 0.1 μ F to 10 μ F output capacitor be used. When doing so, please note the following three points.

1. If the output capacitor is 2.2 μ F or more and the output current is 0.01mA or less^{*1}, the noise level may increase beyond 40 μ V, therefore, it is imperative that the stability of operation including the frequency characteristics be evaluated.
2. If the output capacitor is 0.01 μ F or less and the output current is 0.1mA or less^{*2}, the exogenous noise occurred in the other circuits may give some impacts on the noise level, therefore it is imperative that the enough measures be taken such as to make GND lowered.

As for 1 and 2, please refer to the chart of the External Capacitor vs. Output Voltage.

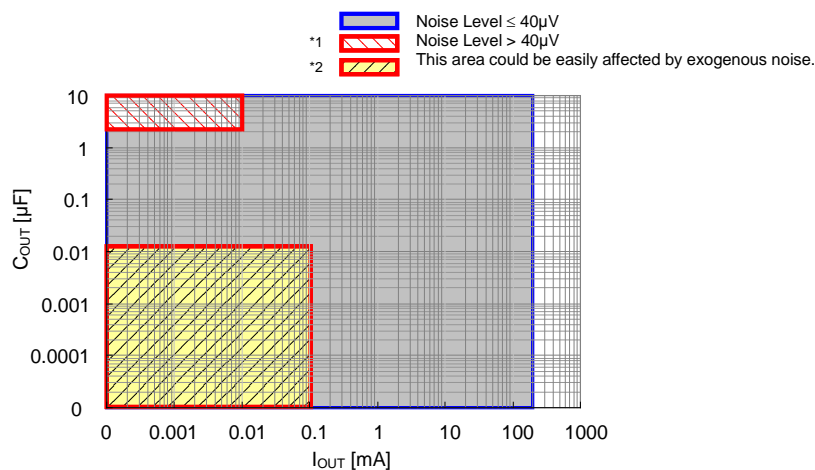

External Capacitor vs. Output Voltage

3. In case of using a tantalum capacitor, the output may oscillate if the effective series resistance (ESR) is high, therefore, it is imperative that the ESR vs. Frequency be considered.

PCB Layout

If the impedances of V_{DD} and GND lines are high, the ICs may pick up noise or may cause unstable operation when the current flows. Therefore, make V_{DD} and GND the lowest possible. Also, place a 0.1 μ F or more C_{IN} capacitor between V_{DD} pin and GND pin as close as possible to each other.

RP107x

NO.EA-181-170424

CONSTANT SLOPE CIRCUITS

The RP107x Series is equipped with a constant slope circuit as a soft-start circuit, which allows the output voltage to start up gradually when the CE is turned on. The constant slope circuit minimizes the inrush current at the start-up and also prevents the overshoot of the output voltage. The capacitor to create the start-up slope is built in the IC that does not require any external components. The start-up time and the start-up slope angle are fixed inside the IC.

If the capacitance of the external output capacitor (C_{OUT}) becomes more than the certain capacitance, the output current limit circuit minimizes the incoming current of the output capacitor at the start-up. As a result, the start-up time becomes longer and the start-up slope angle becomes more gentle. As "Inrush Current Characteristics Example" below shows, if the C_{OUT} is less than $2.2\mu\text{F}$, the constant slope circuit easily starts to function at the start-up, likewise, if the C_{OUT} is over $4.7\mu\text{F}$, the output current limit circuit easily starts to function at the start-up. The boundary point of using these two circuits is inversely proportional to the output voltage. If the output voltage is higher, the output current limit circuit easily starts to function even if the C_{OUT} capacitance is small. For more details, please refer to the graph 15 of "Inrush Current Characteristics Example".

Inrush Current Characteristics Example ($C_1=0.1\mu\text{F}$, $T_{opt}=25^\circ\text{C}$)

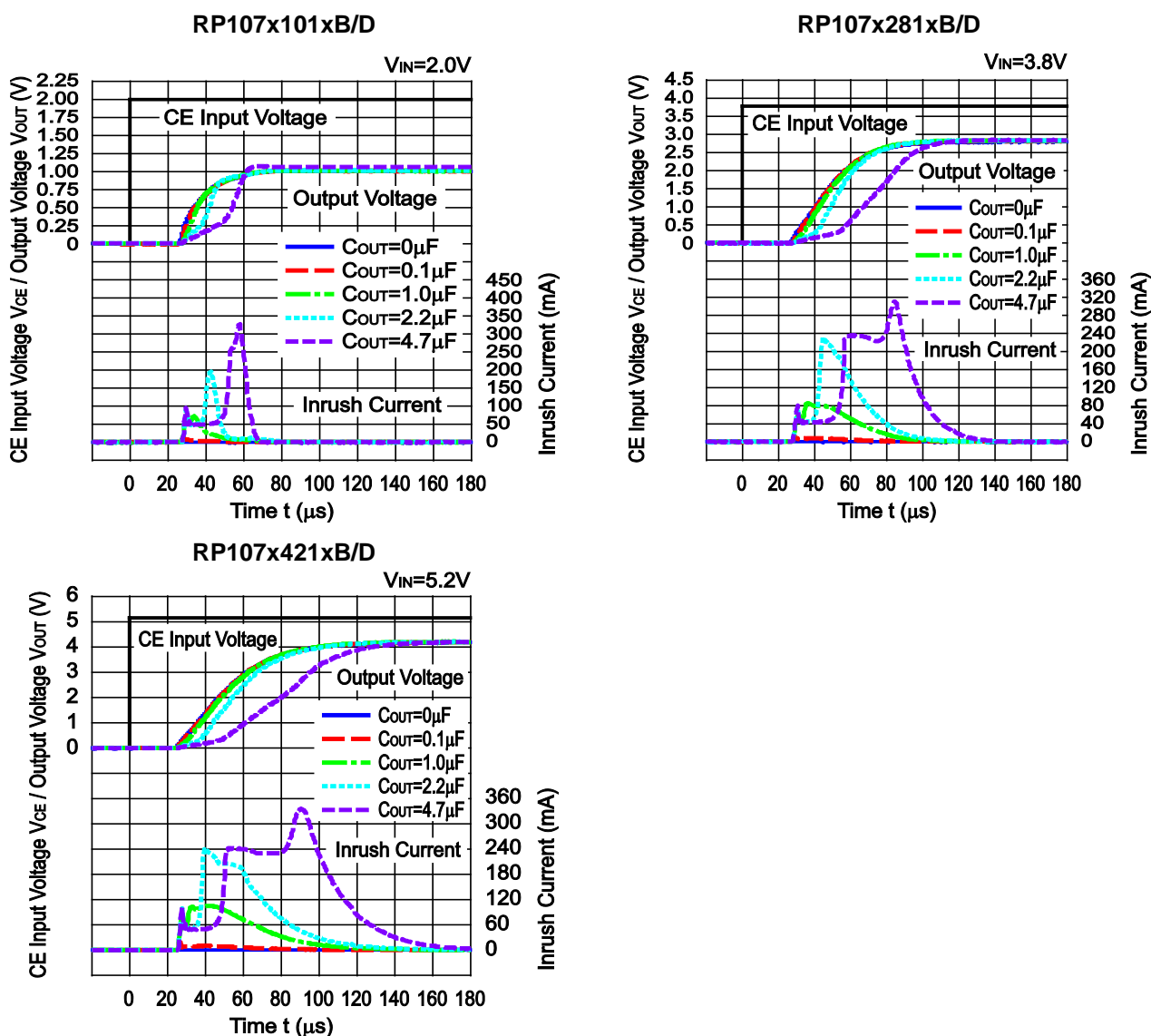

PACKAGE INFORMATION

• Power Dissipation (WLCSP-4-P5)

Power Dissipation (P_D) depends on conditions of mounting on board. This specification is based on the Measurement Conditions below.

Measurement Conditions

	Standard Land Pattern
Environment	Mounting on Board (Wind Velocity=0m/s)
Board Material	Glass Cloth Epoxy Plastic (Double-sided)
Board Dimensions	40mm x 40mm x 1.6mm
Copper Ratio	Topside: Approx. 50%, Backside: Approx. 50%
Through-hole	ϕ 0.5mm x 28pcs

Measurement Result

($T_a=25^\circ\text{C}$, $T_{j\text{max}}=125^\circ\text{C}$)

	Standard Land Pattern
Power Dissipation	278mW
Thermal Resistance	$\theta_{ja}=(125-25^\circ\text{C})/0.278\text{W}=360^\circ\text{C/W}$
	$\theta_{jc}= 46^\circ\text{C/W}$

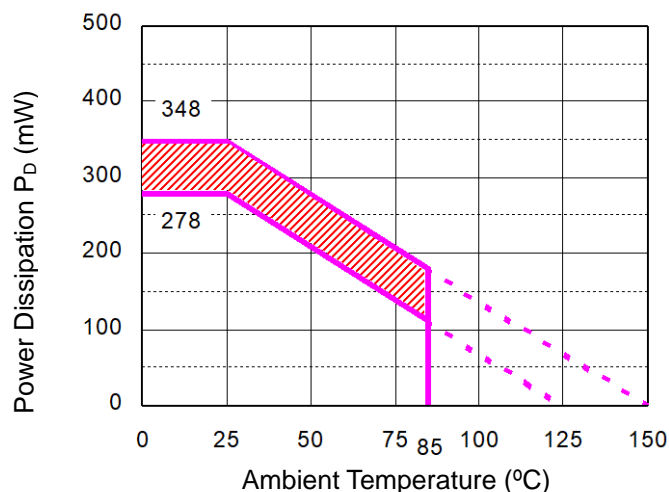

Power Dissipation

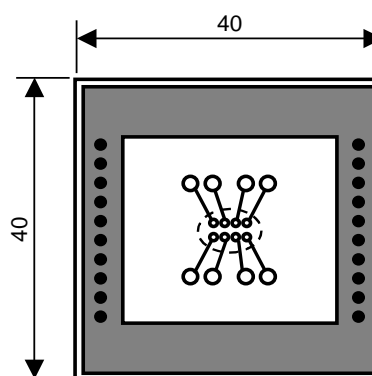

Measurement Board Pattern

IC Mount Area (Unit: mm)

The above graph shows the Power Dissipation of the WLCSP-4-P5 package based on $T_{j\text{max}}=125^\circ\text{C}$ and $T_{j\text{max}}=150^\circ\text{C}$. Operating the ICs within the shaded area in the graph might have an influence on the lifetime of the ICs. Operating time must be within the time limit described in the table below.

Operating Time	Estimated Years (Operating 4 hrs/ day)
13,000 Hours	9 Years

RP107x

NO.EA-181-170424

• **Package Dimensions (WLCSP-4-P5)**

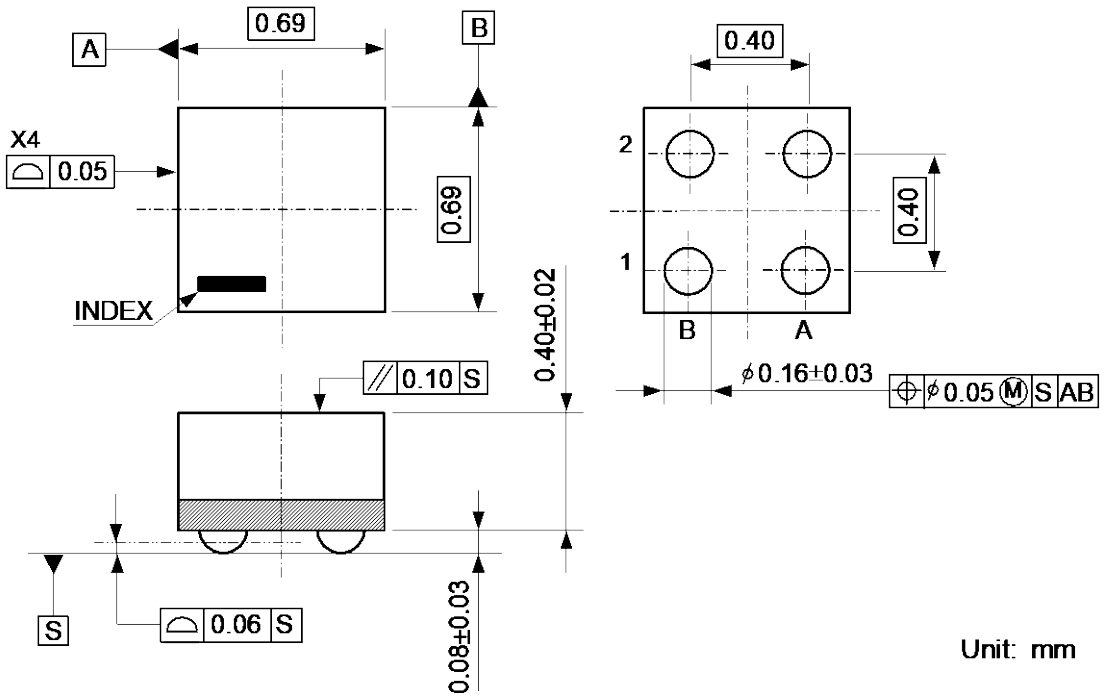

• **Mark Specification (WLCSP-4-P5)**

①②: Lot Number ... Alphanumeric Serial Number

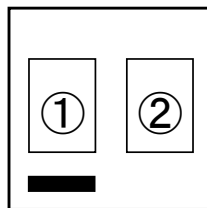

● RP107Z Series Mark Specification Table (WLCSP-4-P5)

RP107ZxxxB		RP107ZxxxD	
Product Name	V _{SET}	Product Name	V _{SET}
RP107Z101B	1.0V	RP107Z101D	1.0V
RP107Z111B	1.1V	RP107Z111D	1.1V
RP107Z121B	1.2V	RP107Z121D	1.2V
RP107Z131B	1.3V	RP107Z131D	1.3V
RP107Z141B	1.4V	RP107Z141D	1.4V
RP107Z151B	1.5V	RP107Z151D	1.5V
RP107Z161B	1.6V	RP107Z161D	1.6V
RP107Z171B	1.7V	RP107Z171D	1.7V
RP107Z181B	1.8V	RP107Z181D	1.8V
RP107Z191B	1.9V	RP107Z191D	1.9V
RP107Z201B	2.0V	RP107Z201D	2.0V
RP107Z211B	2.1V	RP107Z211D	2.1V
RP107Z221B	2.2V	RP107Z221D	2.2V
RP107Z231B	2.3V	RP107Z231D	2.3V
RP107Z241B	2.4V	RP107Z241D	2.4V
RP107Z251B	2.5V	RP107Z251D	2.5V
RP107Z261B	2.6V	RP107Z261D	2.6V
RP107Z271B	2.7V	RP107Z271D	2.7V
RP107Z281B	2.8V	RP107Z281D	2.8V
RP107Z291B	2.9V	RP107Z291D	2.9V
RP107Z301B	3.0V	RP107Z301D	3.0V
RP107Z311B	3.1V	RP107Z311D	3.1V
RP107Z321B	3.2V	RP107Z321D	3.2V
RP107Z331B	3.3V	RP107Z331D	3.3V
RP107Z341B	3.4V	RP107Z341D	3.4V
RP107Z351B	3.5V	RP107Z351D	3.5V
RP107Z361B	3.6V	RP107Z361D	3.6V
RP107Z371B	3.7V	RP107Z371D	3.7V
RP107Z381B	3.8V	RP107Z381D	3.8V
RP107Z391B	3.9V	RP107Z391D	3.9V
RP107Z401B	4.0V	RP107Z401D	4.0V
RP107Z411B	4.1V	RP107Z411D	4.1V
RP107Z421B	4.2V	RP107Z421D	4.2V
RP107Z121B5	1.25V	RP107Z121D5	1.25V
RP107Z181B5	1.85V	RP107Z181D5	1.85V
RP107Z281B5	2.85V	RP107Z281D5	2.85V

*RP107N (SOT-23-5) is the Discontinued product. As of March in 2019.

RP107x

NO.EA-181-170424

• Power Dissipation (DFN(PLP)1212-6)

Power Dissipation (P_D) depends on conditions of mounting on board. This specification is based on the Measurement Conditions below.

Measurement Conditions

	Standard Land Pattern
Environment	Mounting on Board (Wind Velocity=0m/s)
Board Material	Glass Cloth Epoxy Plastic (Double-sided)
Board Dimensions	40mm x 40mm x 1.6mm
Copper Ratio	Topside: Approx. 50%, Backside: Approx. 50%
Through-holes	ϕ 0.54mm x 28pcs

Measurement Result

($T_a=25^\circ\text{C}$, $T_{j\text{max}}=125^\circ\text{C}$)

	Standard Land Pattern
Power Dissipation	400mW
Thermal Resistance	$\theta_{ja} = (125-25^\circ\text{C})/0.4\text{W} = 250^\circ\text{C/W}$
	$\theta_{jc} = 67^\circ\text{C/W}$

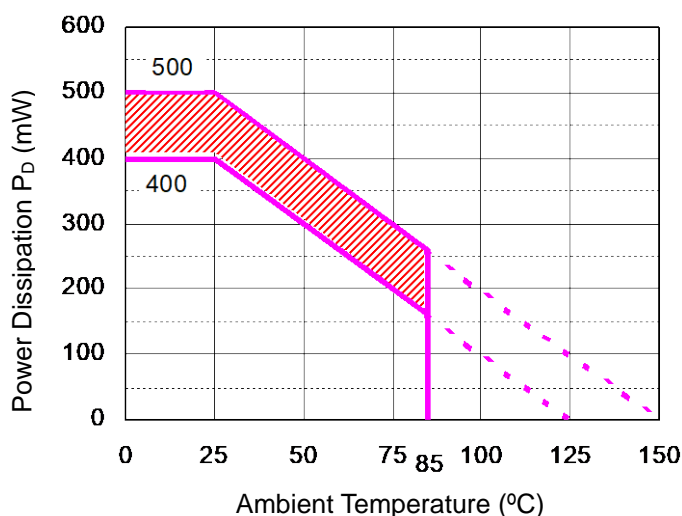

Power Dissipation

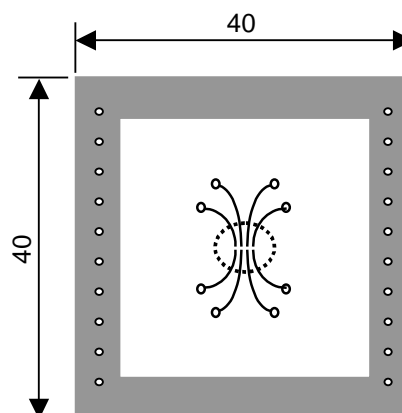

Measurement Board Pattern

 IC Mount Area (Unit: mm)

The above graph shows the Power Dissipation of the DFN(PLP)1212-6 package based on $T_{j\text{max}}=125^\circ\text{C}$ and $T_{j\text{max}}=150^\circ\text{C}$. Operating the ICs within the shaded area in the graph might have an influence on the lifetime of the ICs. Operating time must be within the time limit described in the table below.

Operating Time	Estimated Years (Operating 4 hrs/ day)
13,000 Hours	9 Years

• Package Dimensions (DFN(PLP)1212-6)

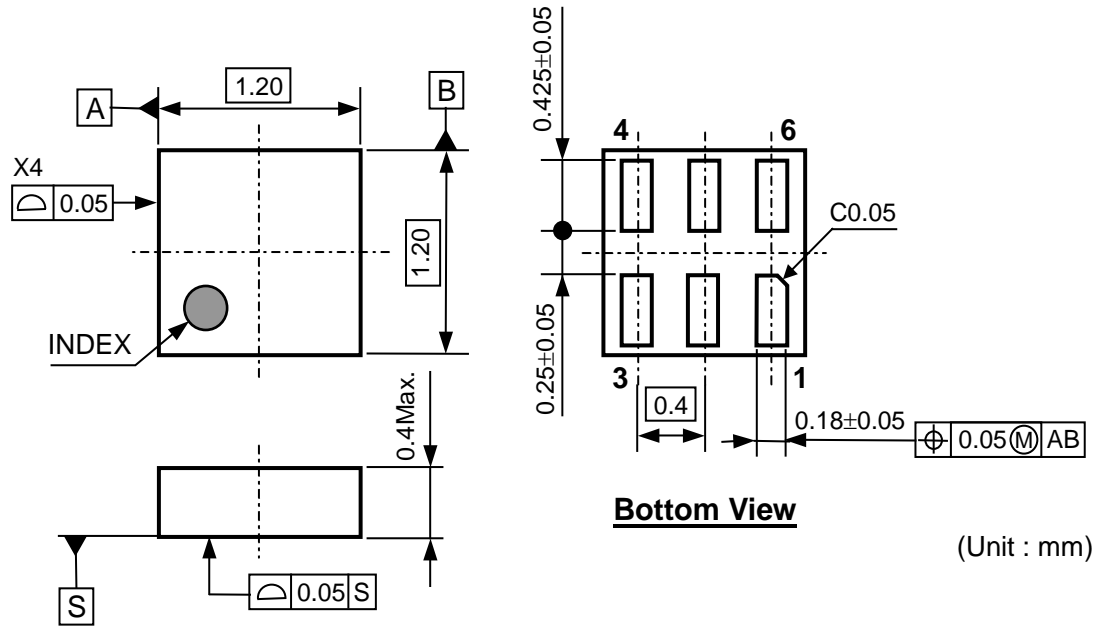

• Mark Specification (DFN(PLP)1212-6)

- ①②: Product Code ... Refer to RP107K Series Mark Specification Table.
- ③④: Lot Number ... Alphanumeric Serial Number

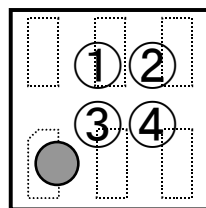

*RP107N (SOT-23-5) is the Discontinued product. As of March in 2019.

RP107x

NO.EA-181-170424

● RP107K Series Mark Specification Table (DFN(PLP)1212-6)

RP107KxxxB

Product Name	①②	V _{SET}
RP107K101B	JA	1.0V
RP107K111B	JB	1.1V
RP107K121B	JC	1.2V
RP107K131B	JD	1.3V
RP107K141B	JE	1.4V
RP107K151B	JF	1.5V
RP107K161B	JG	1.6V
RP107K171B	JH	1.7V
RP107K181B	JJ	1.8V
RP107K191B	JK	1.9V
RP107K201B	JL	2.0V
RP107K211B	JM	2.1V
RP107K221B	JN	2.2V
RP107K231B	JP	2.3V
RP107K241B	JQ	2.4V
RP107K251B	JR	2.5V
RP107K261B	JA	2.6V
RP107K271B	JT	2.7V
RP107K281B	JU	2.8V
RP107K291B	JV	2.9V
RP107K301B	JW	3.0V
RP107K311B	JX	3.1V
RP107K321B	JY	3.2V
RP107K331B	JZ	3.3V
RP107K341B	KA	3.4V
RP107K351B	KB	3.5V
RP107K361B	KC	3.6V
RP107K371B	KD	3.7V
RP107K381B	KE	3.8V
RP107K391B	KF	3.9V
RP107K401B	KG	4.0V
RP107K411B	KH	4.1V
RP107K421B	KJ	4.2V
RP107K121B5	KK	1.25V
RP107K181B5	KL	1.85V
RP107K281B5	KM	2.85V

RP107KxxxD

Product Name	①②	V _{SET}
RP107K101D	LA	1.0V
RP107K111D	LB	1.1V
RP107K121D	LC	1.2V
RP107K131D	LD	1.3V
RP107K141D	LE	1.4V
RP107K151D	LF	1.5V
RP107K161D	LG	1.6V
RP107K171D	LH	1.7V
RP107K181D	LJ	1.8V
RP107K191D	LK	1.9V
RP107K201D	LL	2.0V
RP107K211D	LM	2.1V
RP107K221D	LN	2.2V
RP107K231D	LP	2.3V
RP107K241D	LQ	2.4V
RP107K251D	LR	2.5V
RP107K261D	LA	2.6V
RP107K271D	LT	2.7V
RP107K281D	LU	2.8V
RP107K291D	LV	2.9V
RP107K301D	LW	3.0V
RP107K311D	LX	3.1V
RP107K321D	LY	3.2V
RP107K331D	LZ	3.3V
RP107K341D	MA	3.4V
RP107K351D	MB	3.5V
RP107K361D	MC	3.6V
RP107K371D	MD	3.7V
RP107K381D	ME	3.8V
RP107K391D	MF	3.9V
RP107K401D	MG	4.0V
RP107K411D	MH	4.1V
RP107K421D	MJ	4.2V
RP107K121D5	MK	1.25V
RP107K181D5	ML	1.85V
RP107K281D5	MM	2.85V

● **Power Dissipation (SC-88A)**

Power Dissipation (P_D) depends on conditions of mounting on board. This specification is based on the Measurement Conditions below.

Measurement Conditions

	Standard Land Pattern
Environment	Mounting on Board (Wind Velocity=0m/s)
Board Material	Glass Cloth Epoxy Plastic (Double-sided)
Board Dimensions	40mm x 40mm x 1.6mm
Copper Ratio	Topside: Approx. 50%, Backside: Approx. 50%
Through-hole	$\phi 0.5\text{mm} \times 44\text{pcs}$

Measurement Result

($T_a=25^\circ\text{C}$, $T_{j\text{max}}=125^\circ\text{C}$)

	Standard Land Pattern	Free Air
Power Dissipation	380mW	150mW
Thermal Resistance	$\theta_{ja}=(125-25^\circ\text{C})/0.38\text{W}=263^\circ\text{C/W}$ $\theta_{jc}=75^\circ\text{C/W}$	$\theta_{ja}=(125-25^\circ\text{C})/0.15\text{W}=667^\circ\text{C/W}$ -

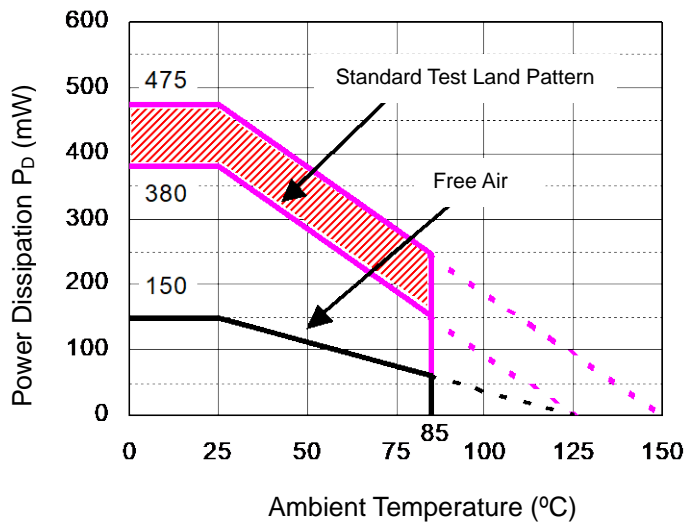

Power Dissipation

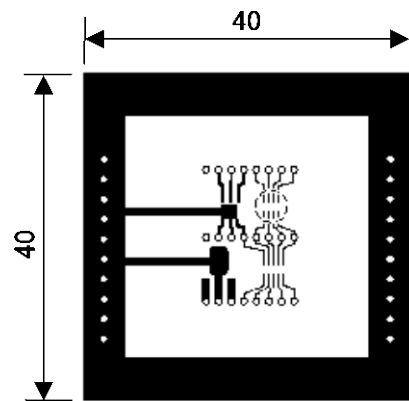

Measurement Board Pattern

○ IC Mount Area (Unit: mm)

The above graph shows the Power Dissipation of the SC-88A package based on $T_{j\text{max}}=125^\circ\text{C}$ and $T_{j\text{max}}=150^\circ\text{C}$. Operating the ICs within the shaded area in the graph might have an influence on the lifetime of the ICs. Operating time must be within the time limit described in the table below.

Operating Time	Estimated Years (Operating 4 hrs/ day)
13,000 Hours	9 Years

*RP107N (SOT-23-5) is the Discontinued product. As of March in 2019.

RP107x

NO.EA-181-170424

• Package Dimensions (SC-88A)

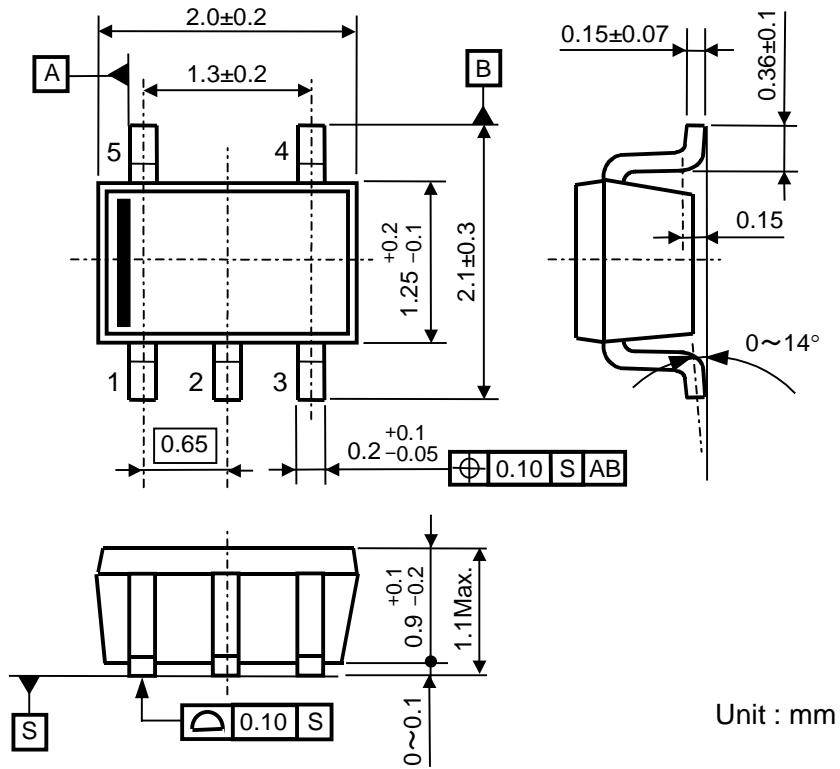

• Mark Specification (SC-88A)

①②③④: Product Code ... Refer to RP107Q Series Mark Specification Table.

⑤⑥: Lot Number ... Alphanumeric Serial Number

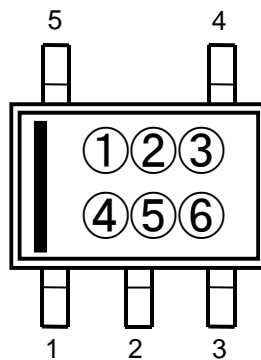

● RP107Q Series Mark Specification Table (SC-88A)

RP107QxxxB			RP107QxxxD		
Product Name	①②③④	V _{SET}	Product Name	①②③④	V _{SET}
RP107Q101B	N 0 1 0	1.0V	RP107Q101D	P 0 1 0	1.0V
RP107Q111B	N 0 1 1	1.1V	RP107Q111D	P 0 1 1	1.1V
RP107Q121B	N 0 1 2	1.2V	RP107Q121D	P 0 1 2	1.2V
RP107Q131B	N 0 1 3	1.3V	RP107Q131D	P 0 1 3	1.3V
RP107Q141B	N 0 1 4	1.4V	RP107Q141D	P 0 1 4	1.4V
RP107Q151B	N 0 1 5	1.5V	RP107Q151D	P 0 1 5	1.5V
RP107Q161B	N 0 1 6	1.6V	RP107Q161D	P 0 1 6	1.6V
RP107Q171B	N 0 1 7	1.7V	RP107Q171D	P 0 1 7	1.7V
RP107Q181B	N 0 1 8	1.8V	RP107Q181D	P 0 1 8	1.8V
RP107Q191B	N 0 1 9	1.9V	RP107Q191D	P 0 1 9	1.9V
RP107Q201B	N 0 2 0	2.0V	RP107Q201D	P 0 2 0	2.0V
RP107Q211B	N 0 2 1	2.1V	RP107Q211D	P 0 2 1	2.1V
RP107Q221B	N 0 2 2	2.2V	RP107Q221D	P 0 2 2	2.2V
RP107Q231B	N 0 2 3	2.3V	RP107Q231D	P 0 2 3	2.3V
RP107Q241B	N 0 2 4	2.4V	RP107Q241D	P 0 2 4	2.4V
RP107Q251B	N 0 2 5	2.5V	RP107Q251D	P 0 2 5	2.5V
RP107Q261B	N 0 2 6	2.6V	RP107Q261D	P 0 2 6	2.6V
RP107Q271B	N 0 2 7	2.7V	RP107Q271D	P 0 2 7	2.7V
RP107Q281B	N 0 2 8	2.8V	RP107Q281D	P 0 2 8	2.8V
RP107Q291B	N 0 2 9	2.9V	RP107Q291D	P 0 2 9	2.9V
RP107Q301B	N 0 3 0	3.0V	RP107Q301D	P 0 3 0	3.0V
RP107Q311B	N 0 3 1	3.1V	RP107Q311D	P 0 3 1	3.1V
RP107Q321B	N 0 3 2	3.2V	RP107Q321D	P 0 3 2	3.2V
RP107Q331B	N 0 3 3	3.3V	RP107Q331D	P 0 3 3	3.3V
RP107Q341B	N 0 3 4	3.4V	RP107Q341D	P 0 3 4	3.4V
RP107Q351B	N 0 3 5	3.5V	RP107Q351D	P 0 3 5	3.5V
RP107Q361B	N 0 3 6	3.6V	RP107Q361D	P 0 3 6	3.6V
RP107Q371B	N 0 3 7	3.7V	RP107Q371D	P 0 3 7	3.7V
RP107Q381B	N 0 3 8	3.8V	RP107Q381D	P 0 3 8	3.8V
RP107Q391B	N 0 3 9	3.9V	RP107Q391D	P 0 3 9	3.9V
RP107Q401B	N 0 4 0	4.0V	RP107Q401D	P 0 4 0	4.0V
RP107Q411B	N 0 4 1	4.1V	RP107Q411D	P 0 4 1	4.1V
RP107Q421B	N 0 4 2	4.2V	RP107Q421D	P 0 4 2	4.2V
RP107Q121B5	N 0 4 3	1.25V	RP107Q121D5	P 0 4 3	1.25V
RP107Q181B5	N 0 4 4	1.85V	RP107Q181D5	P 0 4 4	1.85V
RP107Q281B5	N 0 4 5	2.85V	RP107Q281D5	P 0 4 5	2.85V

RP107x

NO.EA-181-170424

• Power Dissipation (SOT-23-5)

Power Dissipation (P_D) depends on conditions of mounting on board. This specification is based on the Measurement Conditions below. (Power Dissipation (SOT-23-5) is substitution of SOT-23-6.)

Measurement Conditions:

	Standard Land Pattern
Environment	Mounting on Board (Wind Velocity=0m/s)
Board Material	Glass Cloth Epoxy Plastic (Double-sided)
Board Dimensions	40mm x 40mm x 1.6mm
Copper Ratio	Topside: Approx. 50%, Backside: Approx. 50%
Through-holes	ϕ 0.5mm x 44pcs

Measurement Results:

($T_a=25^\circ\text{C}$, $T_{j\text{max}}=125^\circ\text{C}$)

	Standard Land Pattern	Free Air
Power Dissipation	420mW	250mW
Thermal Resistance	$\theta_{ja}=(125-25^\circ\text{C})/0.42\text{W}=238^\circ\text{C/W}$	400 $^\circ\text{C/W}$

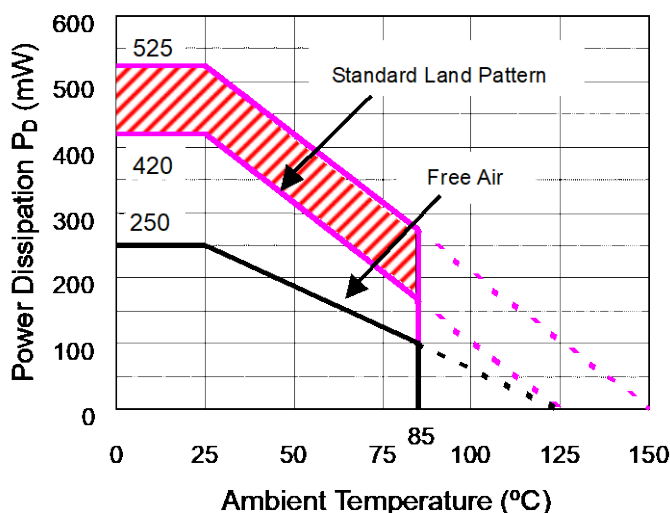

Power Dissipation

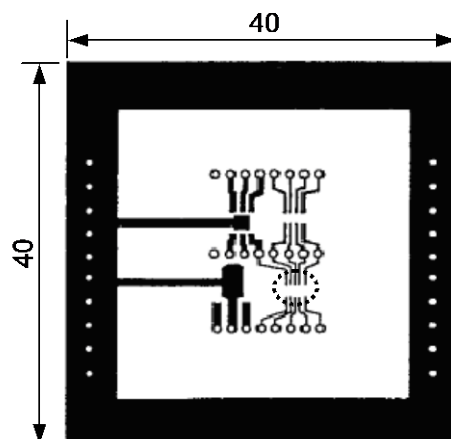

Measurement Board Pattern

 IC Mount Area (Unit: mm)

The above graph shows the Power Dissipation of the SOT-23-5 package based on $T_{j\text{max}}=125^\circ\text{C}$ and $T_{j\text{max}}=150^\circ\text{C}$. Operating the ICs within the shaded area in the graph might have an influence on the lifetime of the ICs. Operating time must be within the time limit described in the table below.

Operating Time	Estimated Years (Operating 4 hrs/ day)
9,000 Hours	6 Years

● Package Dimensions (SOT-23-5)

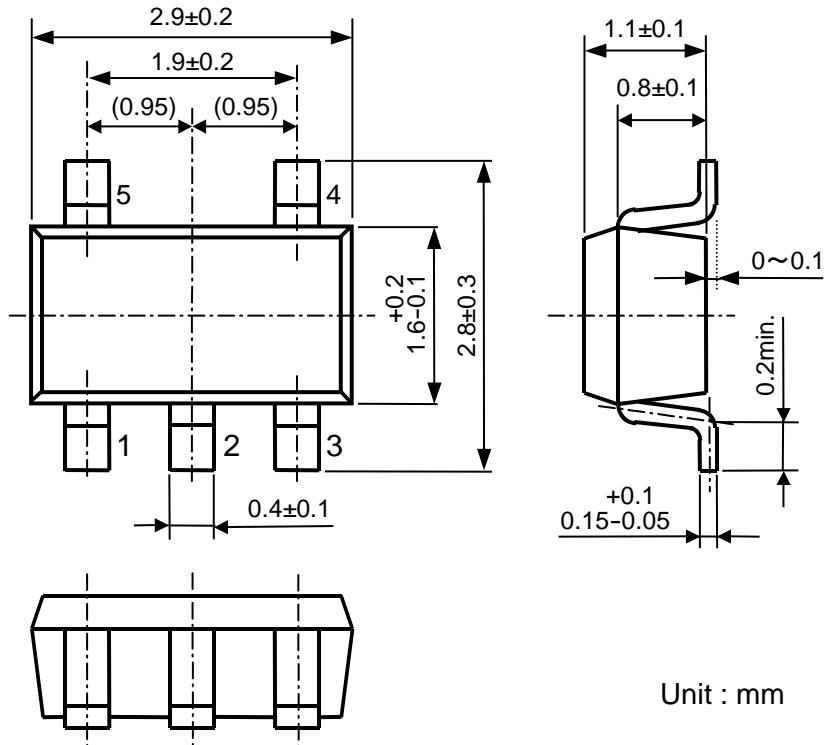

● Mark Specification (SOT-23-5)

①②③: Product Code ... Refer to RP107N Series Mark Specification Table.

④⑤: Lot Number ... Alphanumeric Serial Number

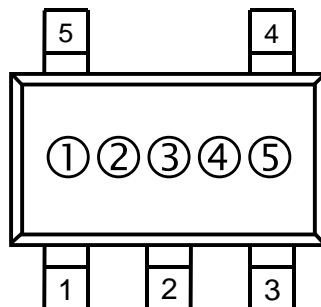

*RP107N (SOT-23-5) is the Discontinued product. As of March in 2019.

RP107x

NO.EA-181-170424

● RP107N Series Mark Specification Table (SOT-23-5)

RP107NxxxB			RP107NxxxD		
Product Name	①②③	V _{SET}	Product Name	①②③	V _{SET}
RP107N101B	A A A	1.0V	RP107N101D	A B A	1.0V
RP107N111B	A A B	1.1V	RP107N111D	A B B	1.1V
RP107N121B	A A C	1.2V	RP107N121D	A B C	1.2V
RP107N131B	A A D	1.3V	RP107N131D	A B D	1.3V
RP107N141B	A A E	1.4V	RP107N141D	A B E	1.4V
RP107N151B	A A F	1.5V	RP107N151D	A B F	1.5V
RP107N161B	A A G	1.6V	RP107N161D	A B G	1.6V
RP107N171B	A A H	1.7V	RP107N171D	A B H	1.7V
RP107N181B	A A J	1.8V	RP107N181D	A B J	1.8V
RP107N191B	A A K	1.9V	RP107N191D	A B K	1.9V
RP107N201B	A A L	2.0V	RP107N201D	A B L	2.0V
RP107N211B	A A M	2.1V	RP107N211D	A B M	2.1V
RP107N221B	A A N	2.2V	RP107N221D	A B N	2.2V
RP107N231B	A A P	2.3V	RP107N231D	A B P	2.3V
RP107N241B	A A Q	2.4V	RP107N241D	A B Q	2.4V
RP107N251B	A A R	2.5V	RP107N251D	A B R	2.5V
RP107N261B	A A S	2.6V	RP107N261D	A B S	2.6V
RP107N271B	A A T	2.7V	RP107N271D	A B T	2.7V
RP107N281B	A A U	2.8V	RP107N281D	A B U	2.8V
RP107N291B	A A V	2.9V	RP107N291D	A B V	2.9V
RP107N301B	A A W	3.0V	RP107N301D	A B W	3.0V
RP107N311B	A A X	3.1V	RP107N311D	A B X	3.1V
RP107N321B	A A Y	3.2V	RP107N321D	A B Y	3.2V
RP107N331B	A A Z	3.3V	RP107N331D	A B Z	3.3V
RP107N341B	B A A	3.4V	RP107N341D	B B A	3.4V
RP107N351B	B A B	3.5V	RP107N351D	B B B	3.5V
RP107N361B	B A C	3.6V	RP107N361D	B B C	3.6V
RP107N371B	B A D	3.7V	RP107N371D	B B D	3.7V
RP107N381B	B A E	3.8V	RP107N381D	B B E	3.8V
RP107N391B	B A F	3.9V	RP107N391D	B B F	3.9V
RP107N401B	B A G	4.0V	RP107N401D	B B G	4.0V
RP107N411B	B A H	4.1V	RP107N411D	B B H	4.1V
RP107N421B	B A J	4.2V	RP107N421D	B B J	4.2V
RP107N121B5	B A K	1.25V	RP107N121D5	B B K	1.25V
RP107N181B5	B A L	1.85V	RP107N181D5	B B L	1.85V
RP107N281B5	B A M	2.85V	RP107N281D5	B B M	2.85V

TEST CIRCUITS

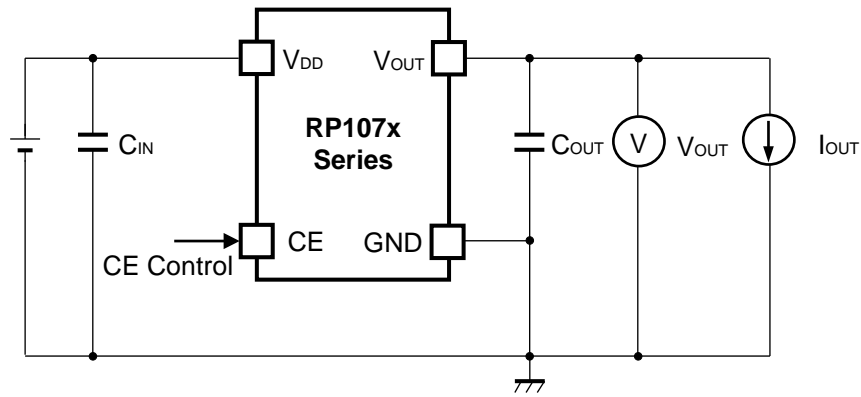

Basic Test Circuit

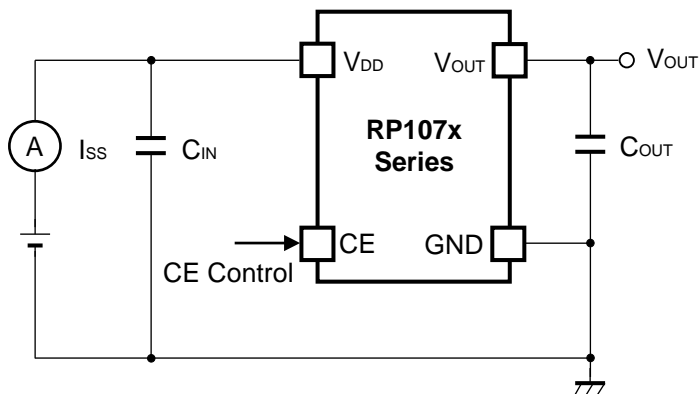

Test Circuit for Supply Current

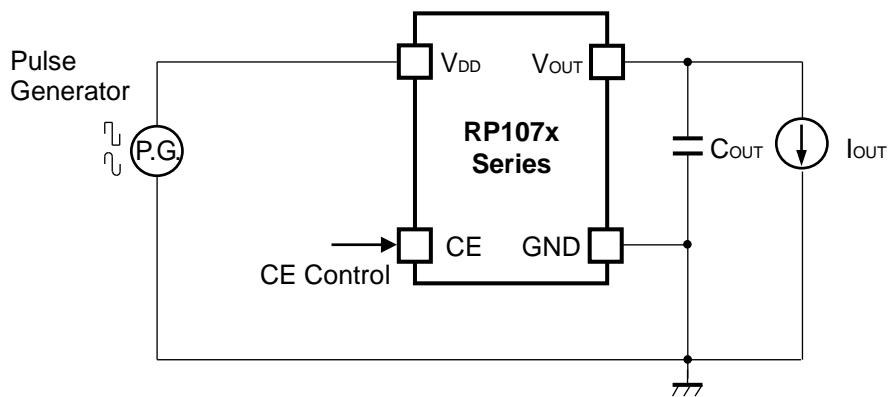

Test Circuit for Ripple Rejection

*RP107N (SOT-23-5) is the Discontinued product. As of March in 2019.

RP107x

NO.EA-181-170424

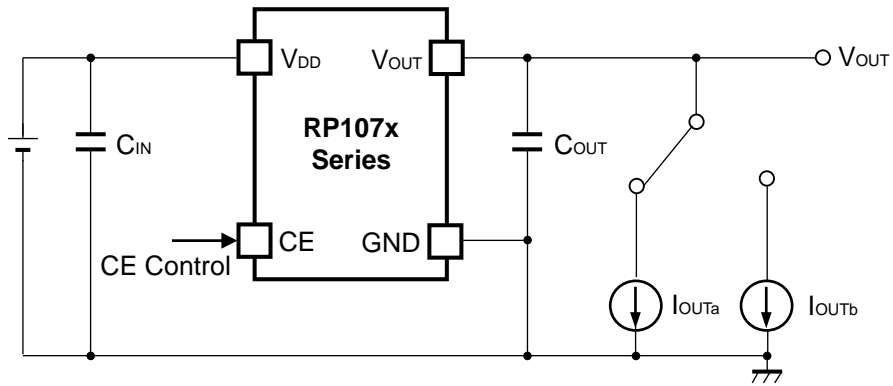

Test Circuit for Load Transient Response

TYPICAL CHARACTERISTICS

1) Output Voltage vs. Output Current ($C_{IN}=0.1\mu F$, $T_{opt}=25^{\circ}C$)

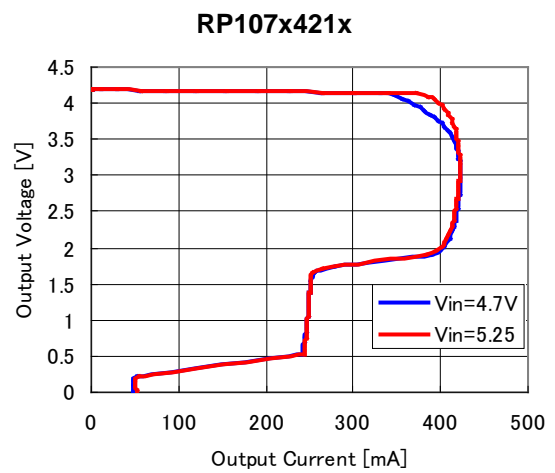
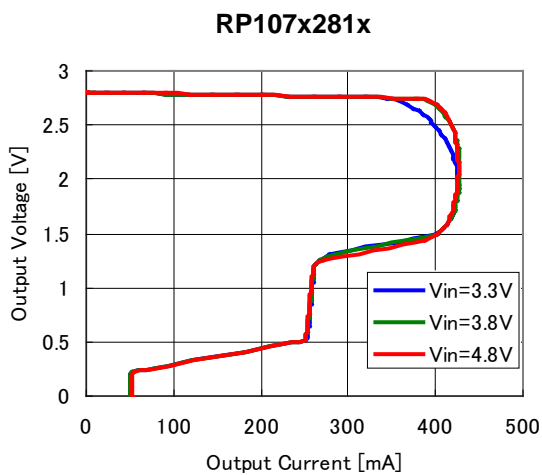
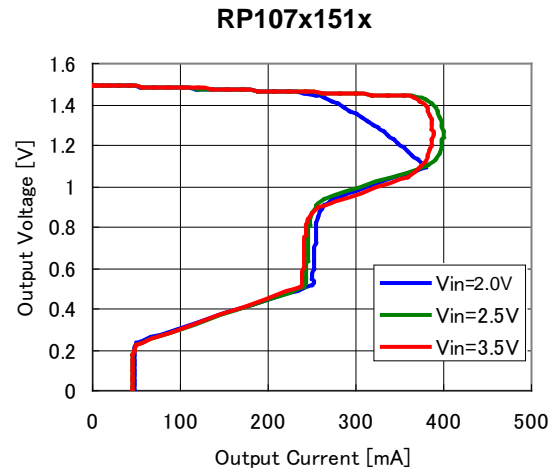
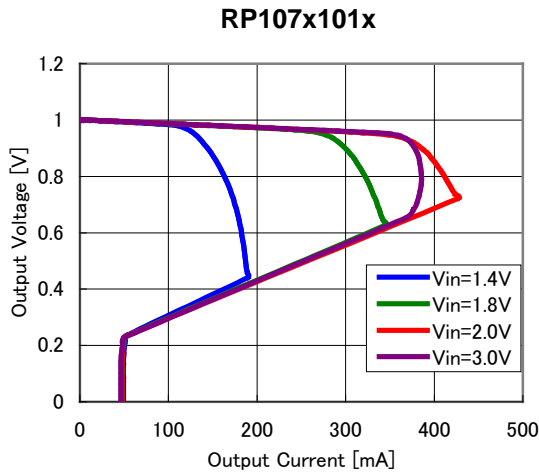

2) Output Voltage vs. Input Voltage ($C_{IN}=0.1\mu F$, $T_{opt}=25^{\circ}C$)

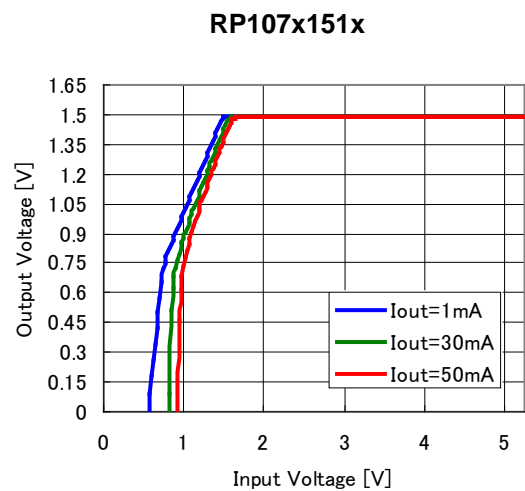
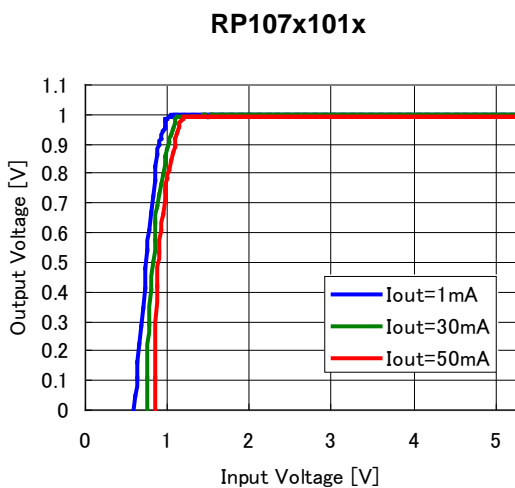

*RP107N (SOT-23-5) is the Discontinued product. As of March in 2019.

RP107x

NO.EA-181-170424

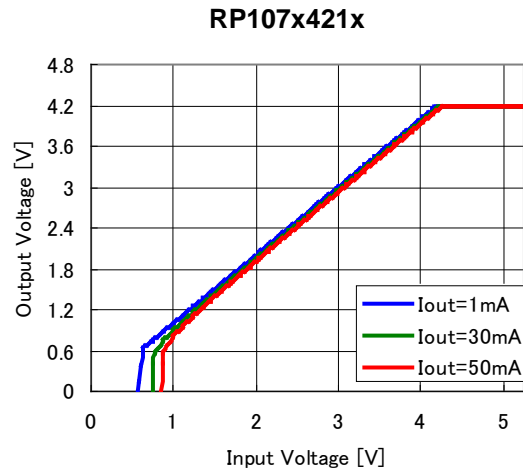
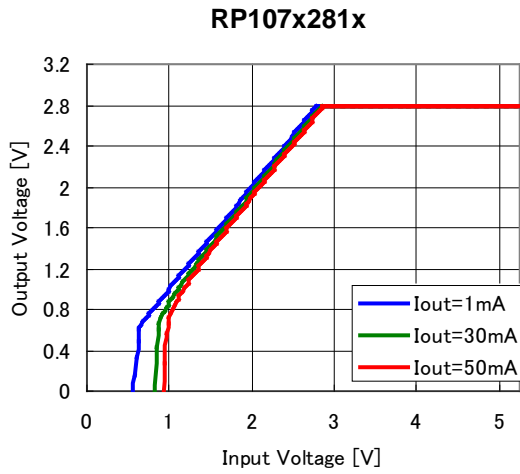

3) Supply Current vs. Input Voltage ($C_{IN}=0.1\mu F$, $T_{opt}=25^{\circ}C$)

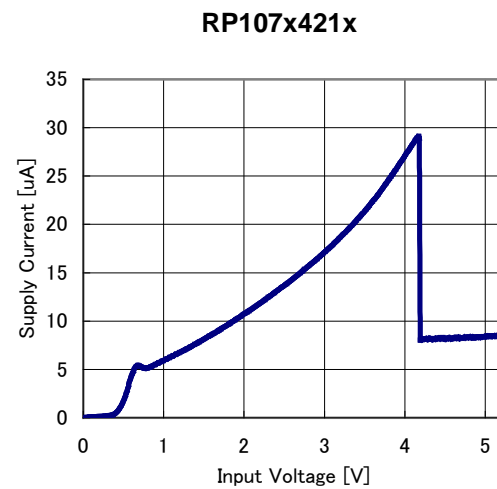
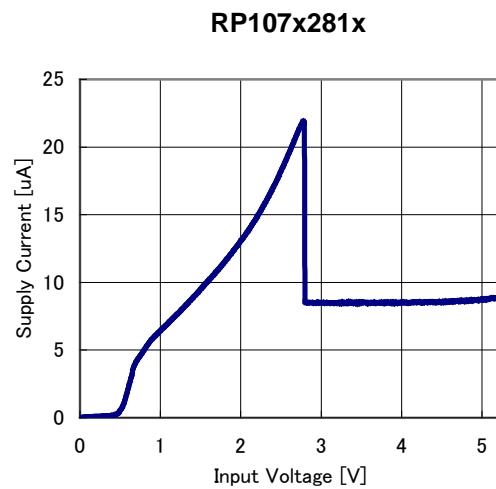
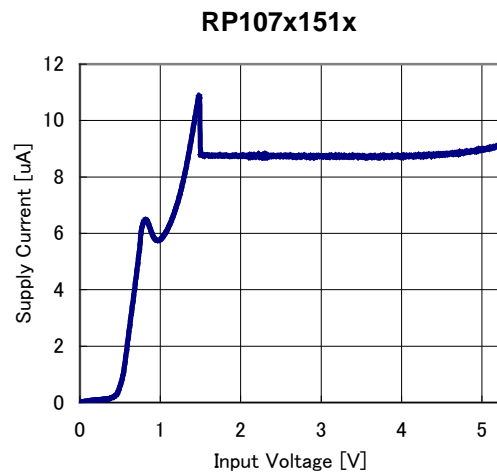
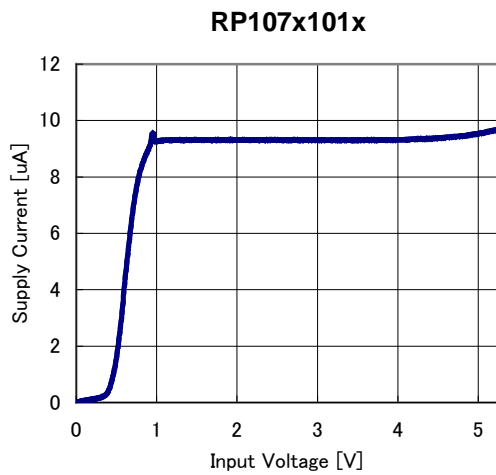

4) Output Voltage vs. Temperature ($C_{IN}=0.1\mu F$, $I_{OUT}=1mA$)

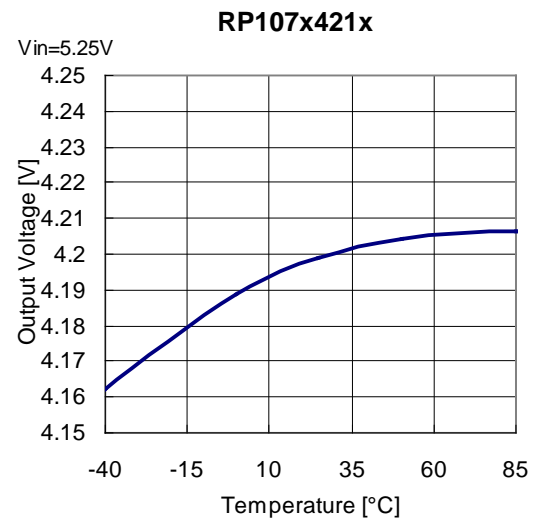
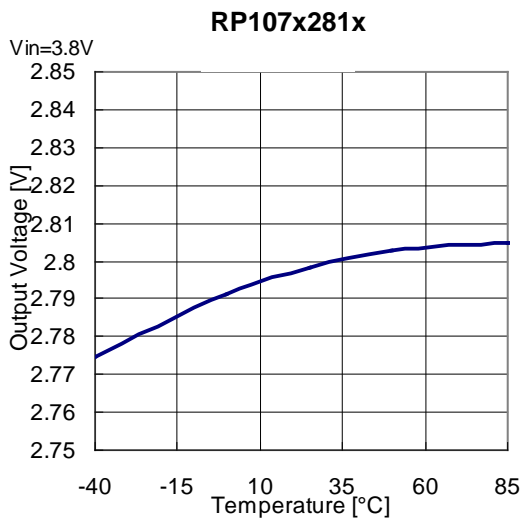
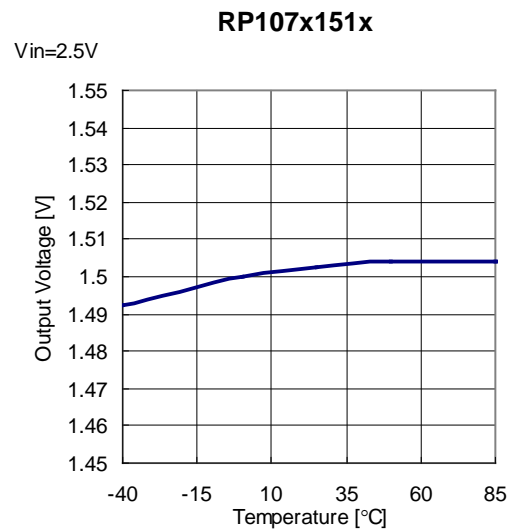
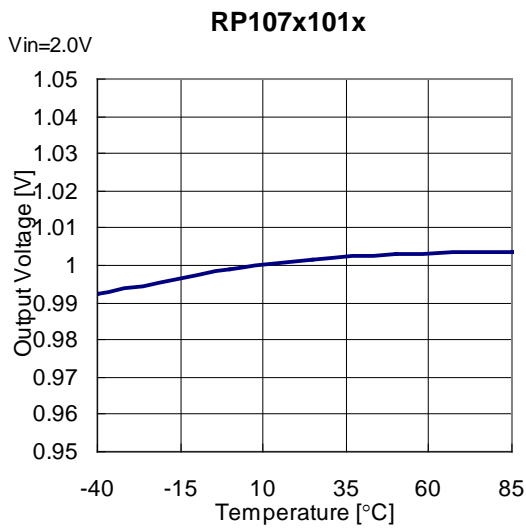

5) Supply Current vs. Temperature ($C_{IN}=0.1\mu F$, $I_{OUT}=0mA$)

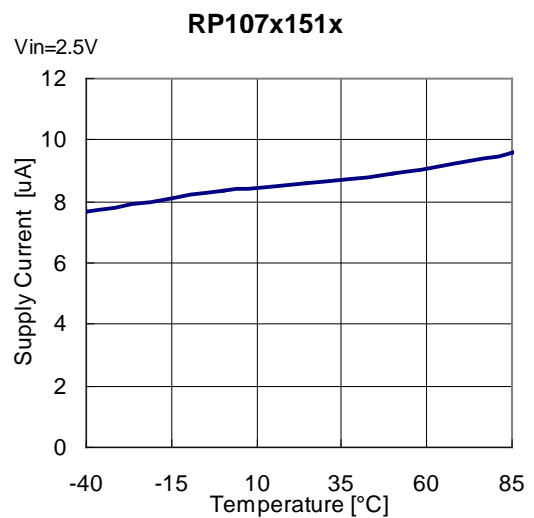
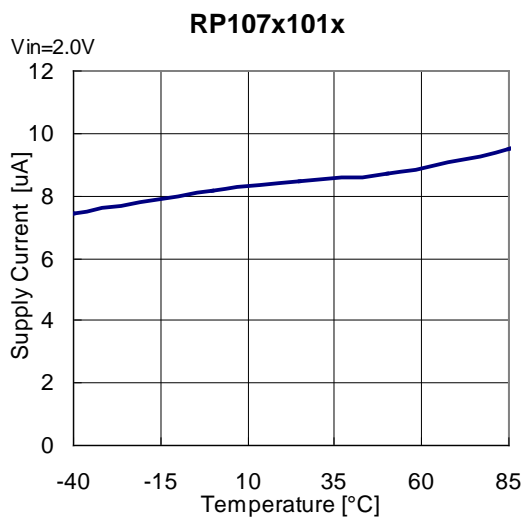

*RP107N (SOT-23-5) is the Discontinued product. As of March in 2019.

RP107x

NO.EA-181-170424

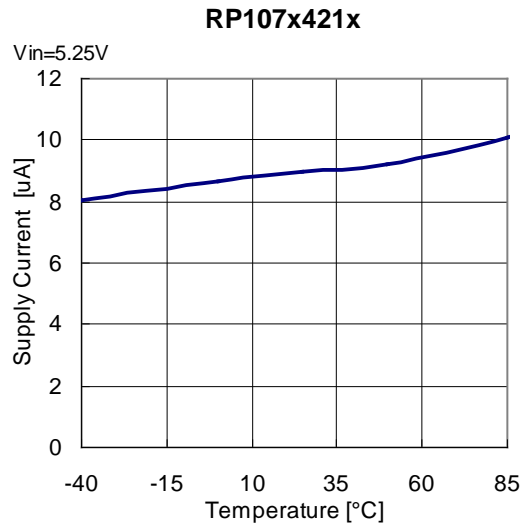
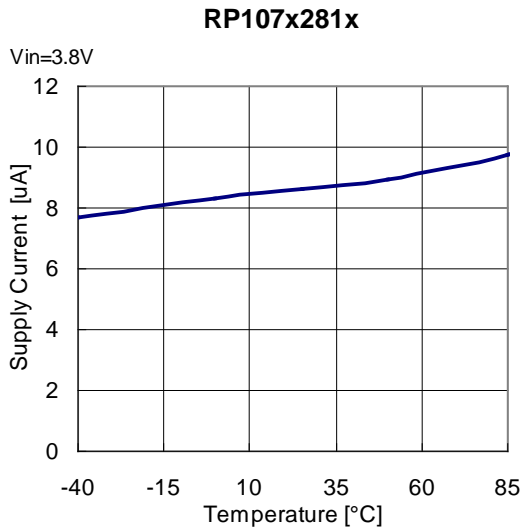

6) Dropout Voltage vs. Output Current (C_{IN}=0.1μF)

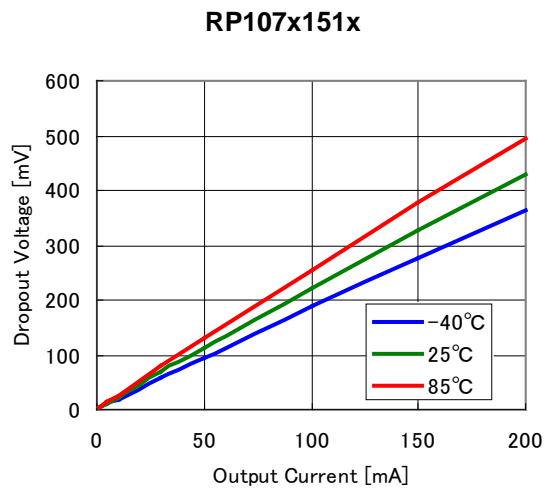
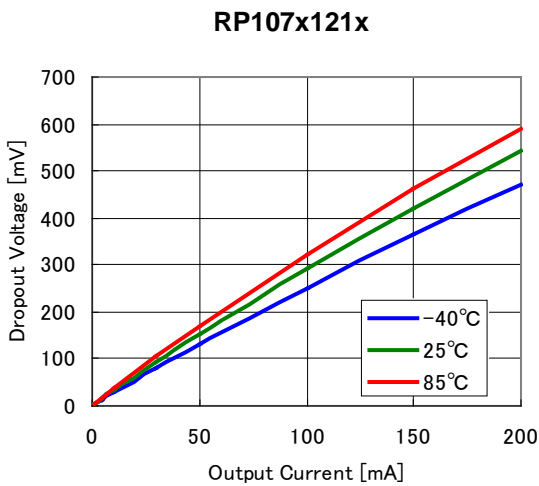
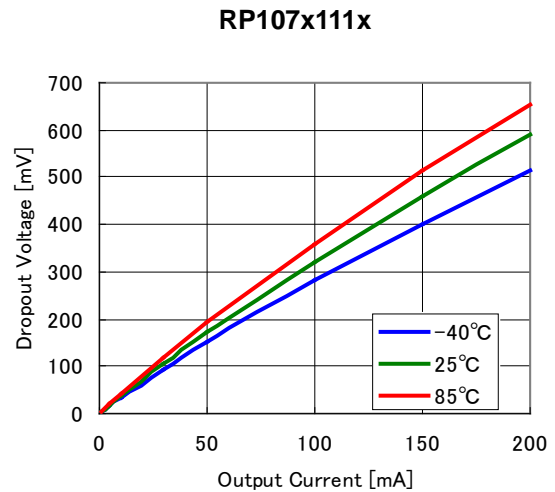
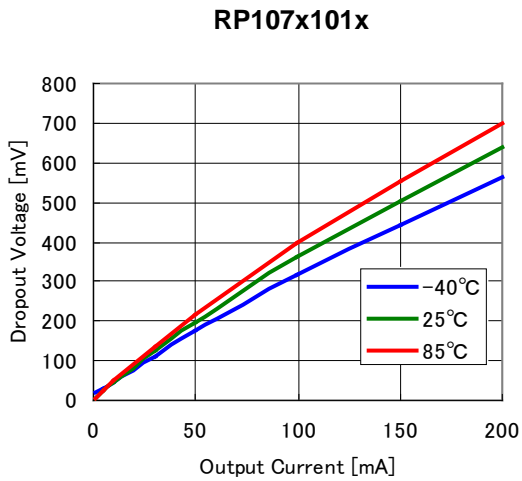

*RP107N (SOT-23-5) is the Discontinued product. As of March in 2019.

RP107x

NO.EA-181-170424

RP107x201x

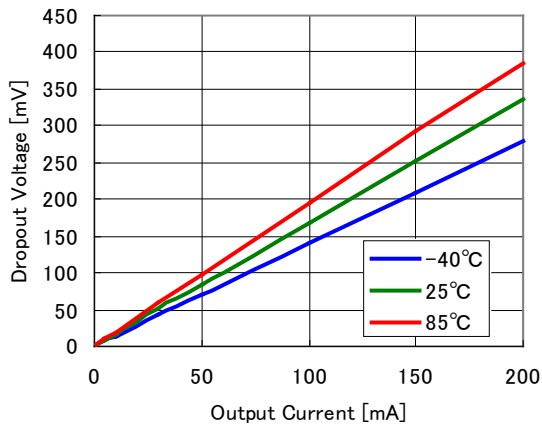

RP107x301x

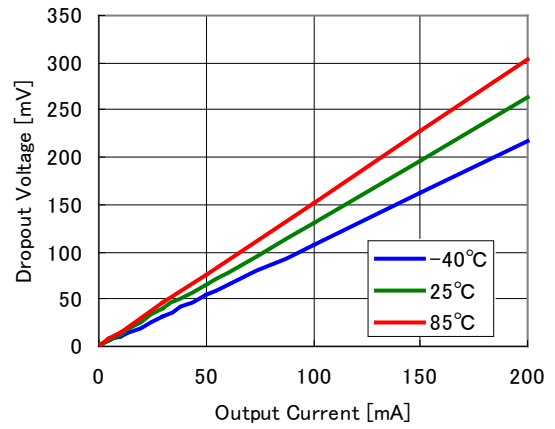

RP107x421x

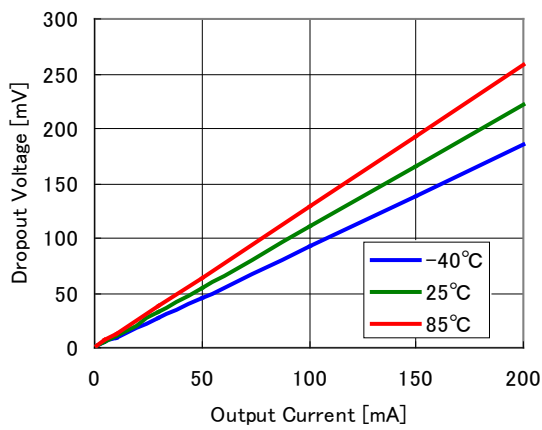

7) Dropout Voltage vs. Set Output Voltage (C_{IN}=0.1μF)

RP107x

I_{out}=1mA

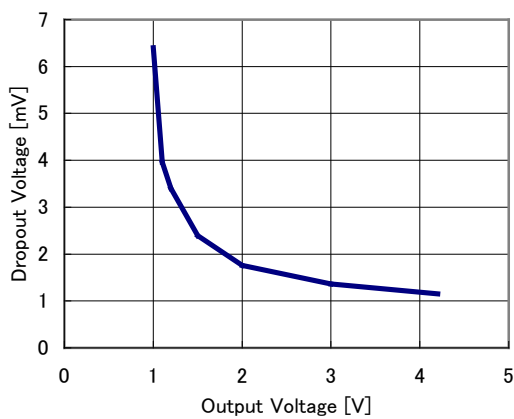

RP107x

I_{out}=30mA

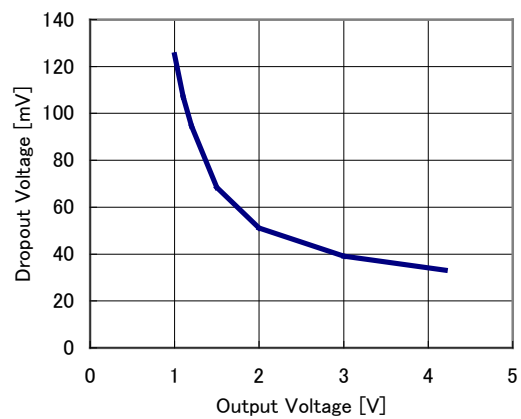

*RP107N (SOT-23-5) is the Discontinued product. As of March in 2019.

RP107x

NO.EA-181-170424

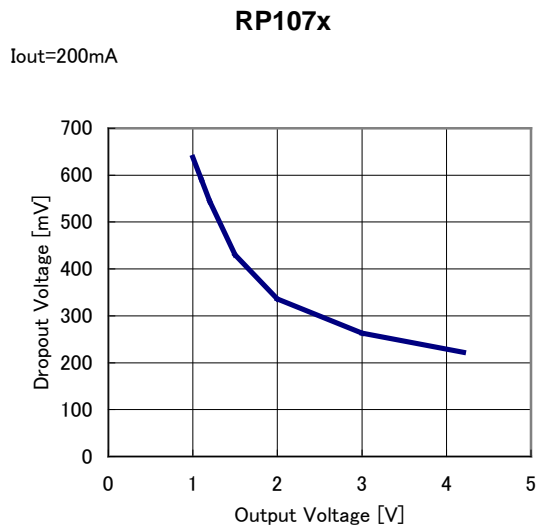
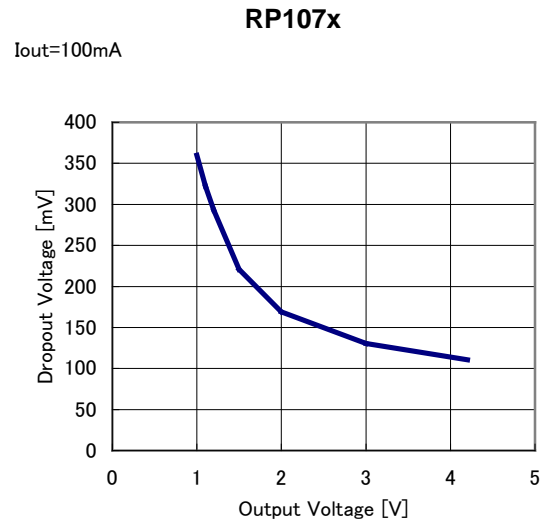
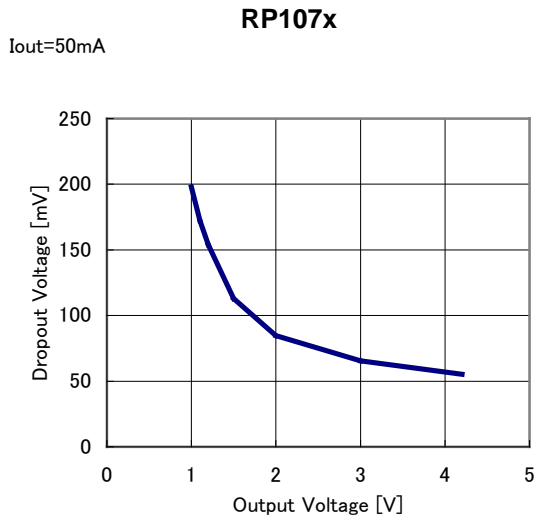

8) Minimum Operating Voltage (C_{IN}=0.1μF)

RP107x101x

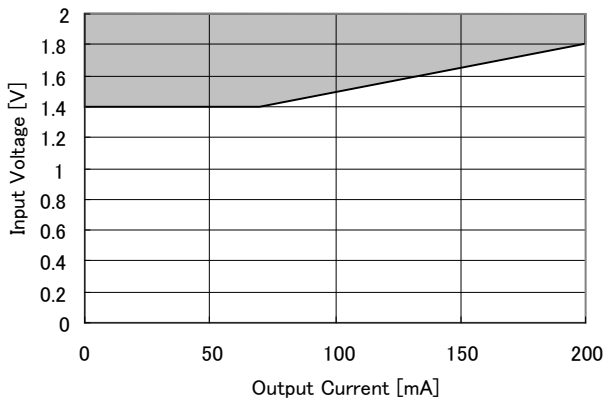

Hatched area is available
for 1.0V output

9) Ripple Rejection vs. Frequency (C_{IN} =none, T_{opt} =25°C)

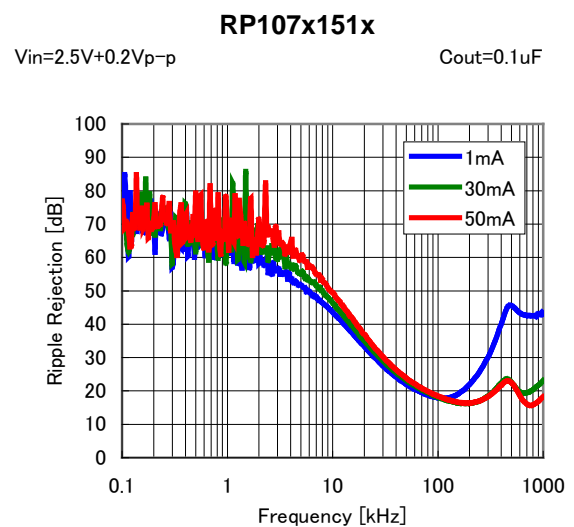
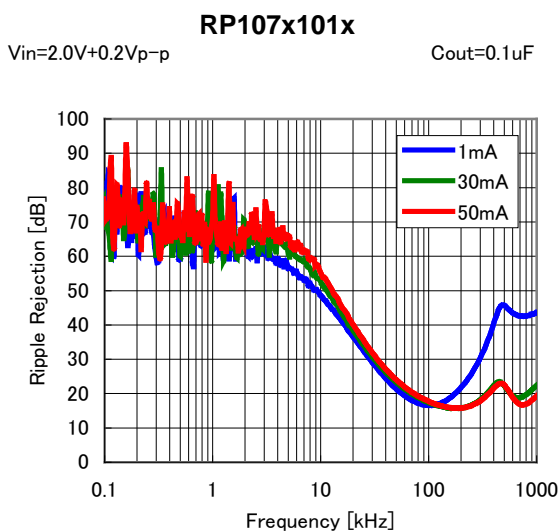
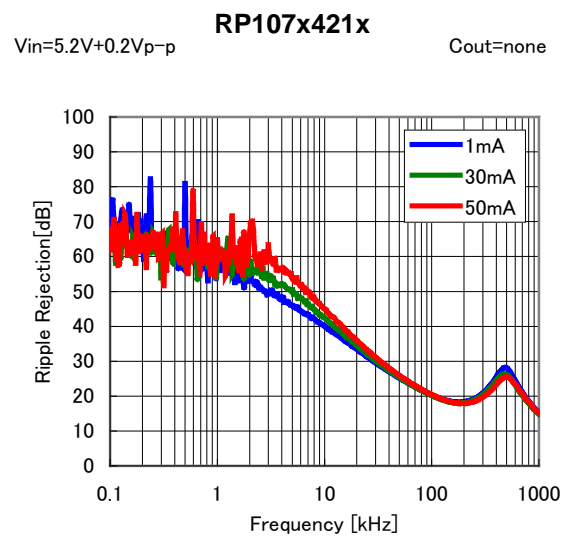
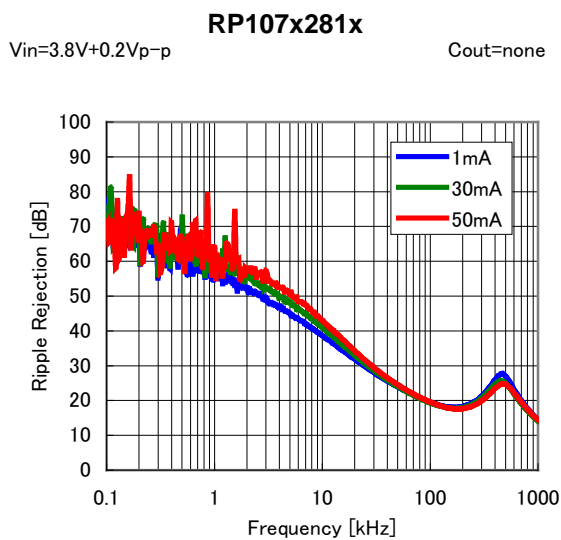
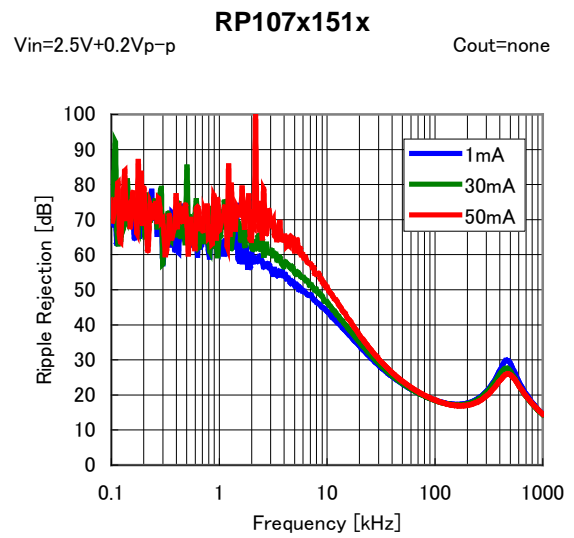
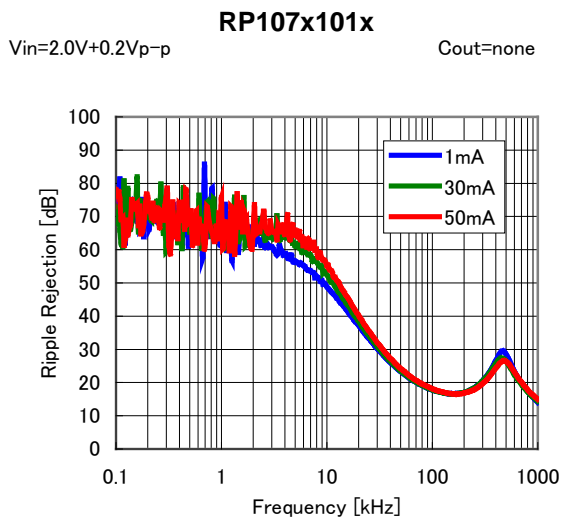

*RP107N (SOT-23-5) is the Discontinued product. As of March in 2019.

RP107x

NO.EA-181-170424

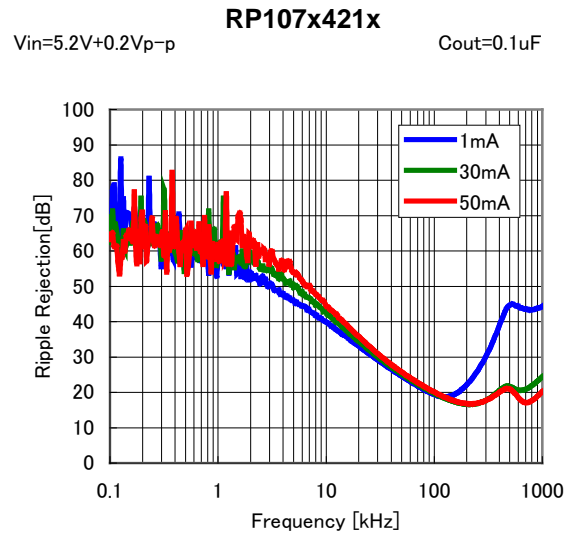
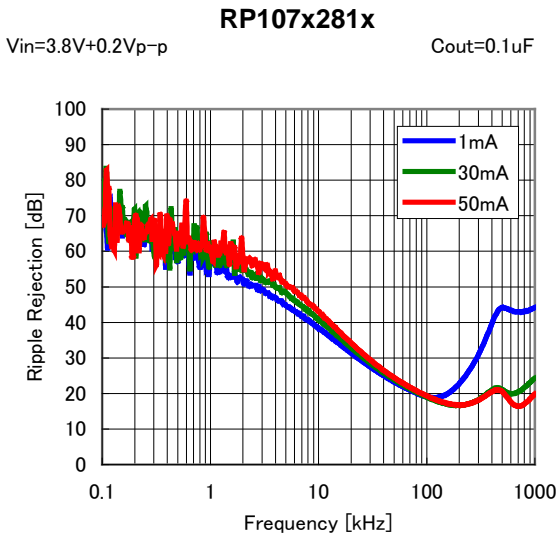

10) Ripple Rejection vs. Input Bias Voltage ($C_{OUT}=0.1\mu F$, Ripple= $0.2V_{p-p}$, $T_{opt}=25^{\circ}C$)

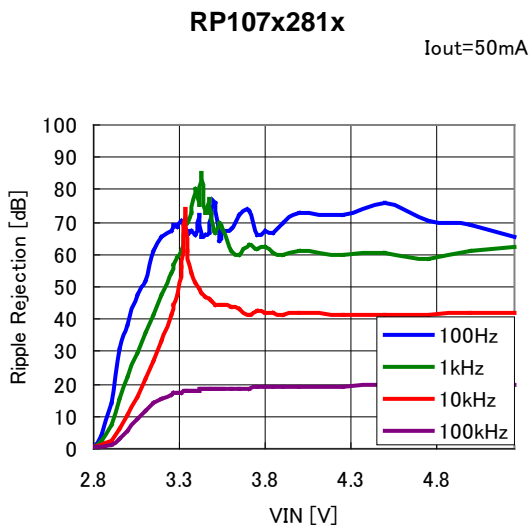
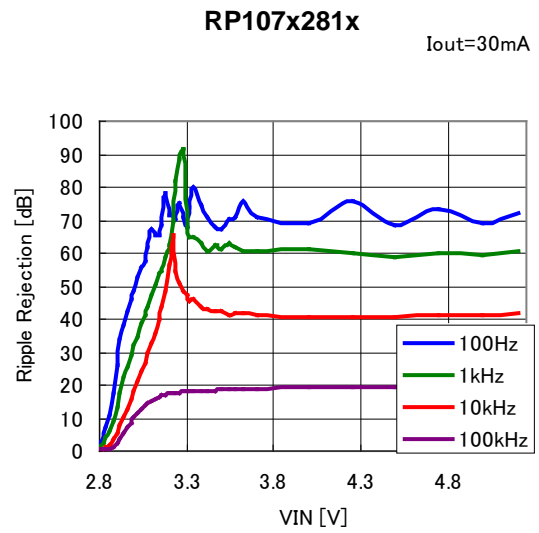
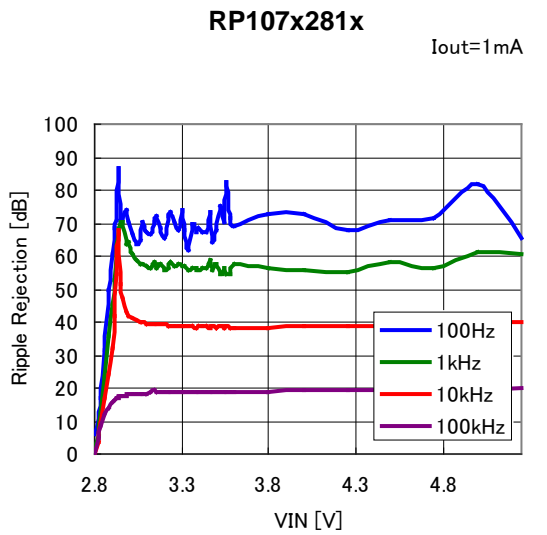

11) Input Transient Response (C_{IN} =none, I_{OUT} =30mA, $t_r=t_f$ =5 μ s, T_{opt} =25°C)

RP107x101x

V_{in} :2V \leftrightarrow 3V

C_{out} =none

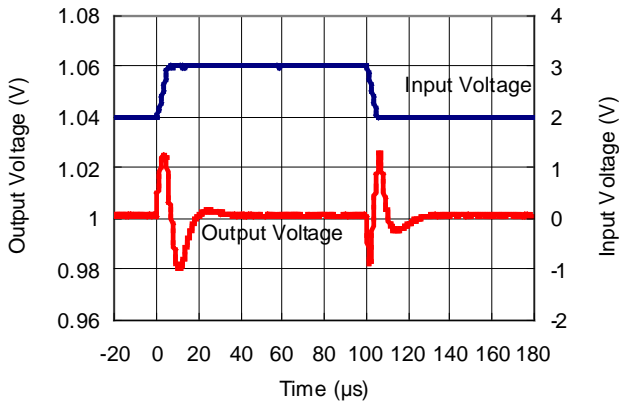

RP107x101x

V_{in} :2V \leftrightarrow 3V

C_{out} =Ceramic 0.1 μ F

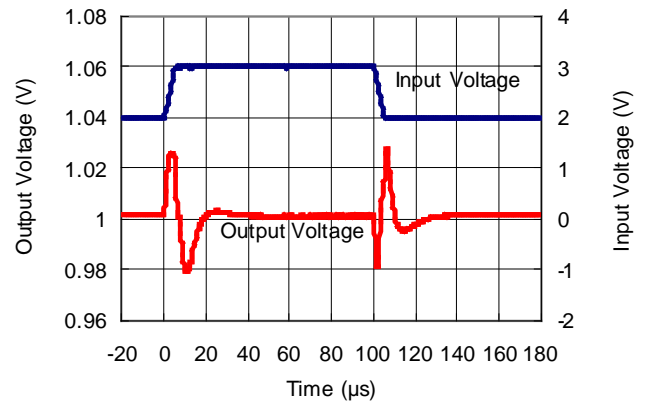

RP107x151x

V_{in} :2.5V \leftrightarrow 3.5V

C_{out} =none

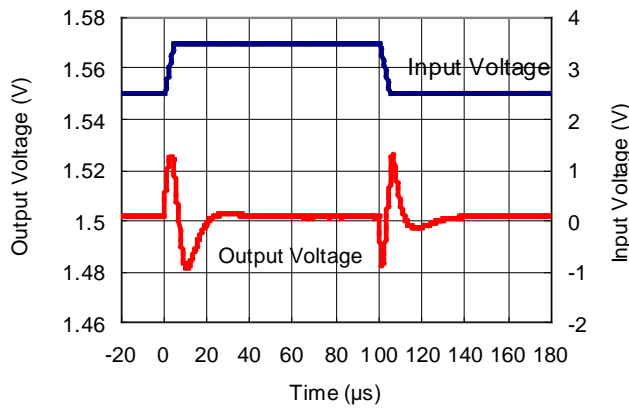

RP107x151x

V_{in} :2.5V \leftrightarrow 3.5V

C_{out} =Ceramic 0.1 μ F

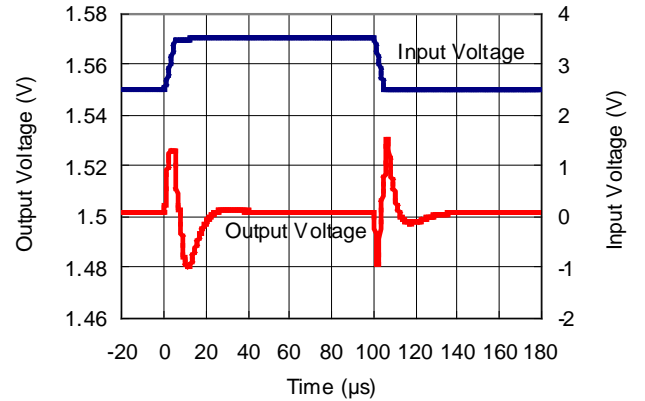

RP107x281x

V_{in} :3.8V \leftrightarrow 4.8V

C_{out} =none

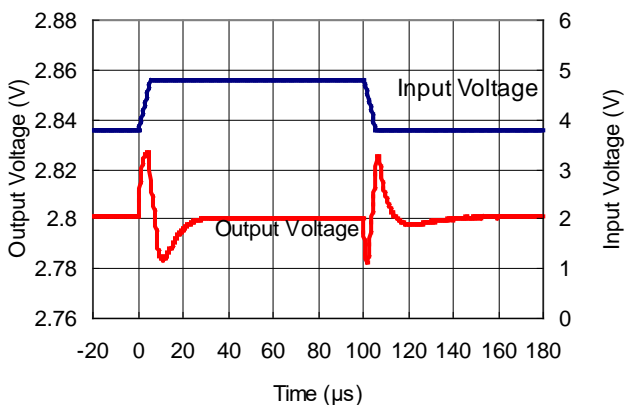

RP107x281x

V_{in} :3.8V \leftrightarrow 4.8V

C_{out} =Ceramic 0.1 μ F

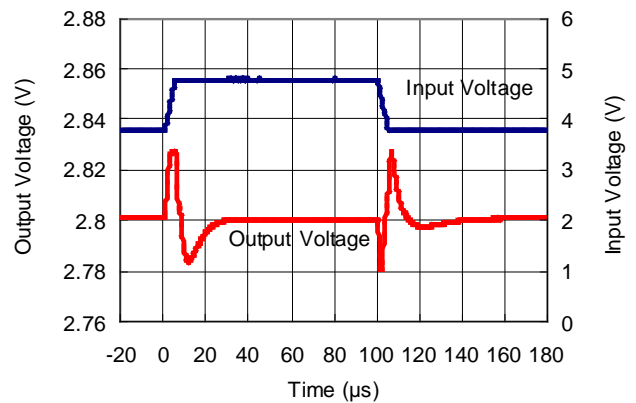

*RP107N (SOT-23-5) is the Discontinued product. As of March in 2019.

RP107x

NO.EA-181-170424

RP107x421x

Vin: 4.5V ⇄ 5.5V

Cout=none

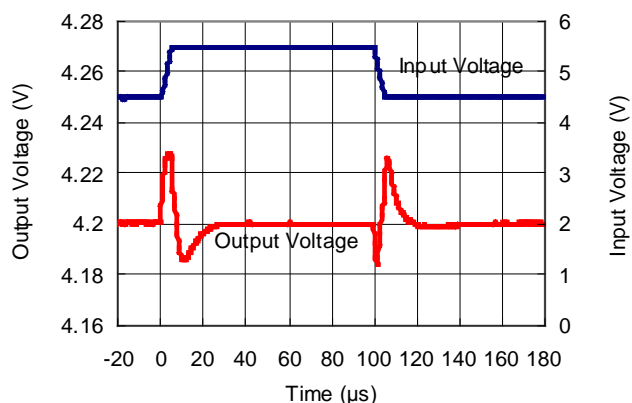

RP107x421x

Vin: 4.5V ⇄ 5.5V

Cout=Ceramic 0.1μF

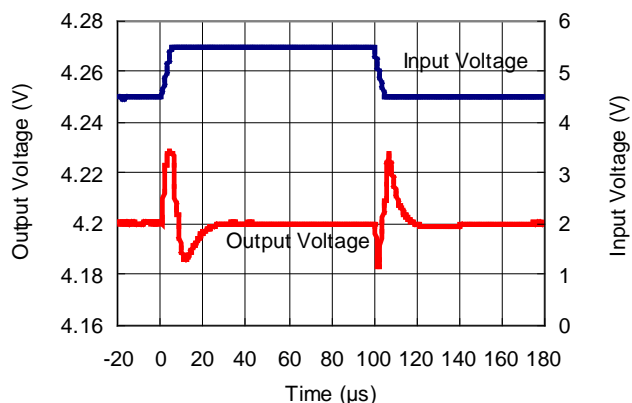

12) Load Transient Response (C_{IN}=0.1μF, T_{opt}=25°C)

RP107x101x

Tr=Tf: 2μs
Iout : 5mA ⇄ 50mA

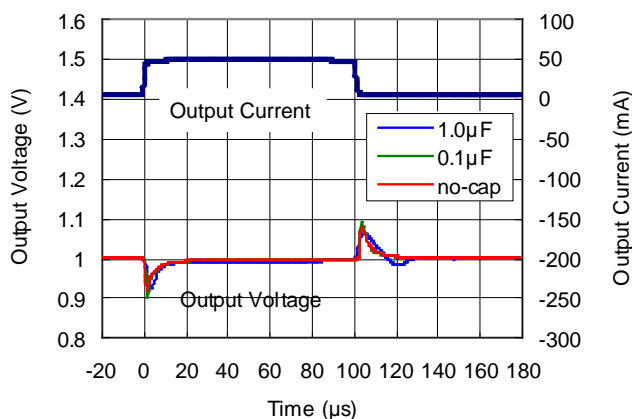

RP107x101x

Tr=Tf: 0.5μs
Iout : 50mA ⇄ 100mA

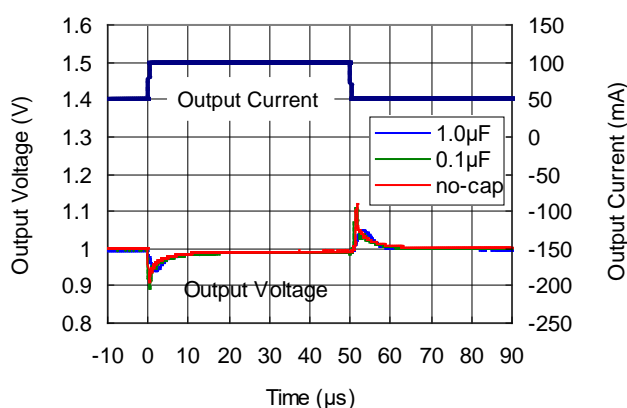

RP107x151x

Tr=Tf: 2μs
Iout : 5mA ⇄ 50mA

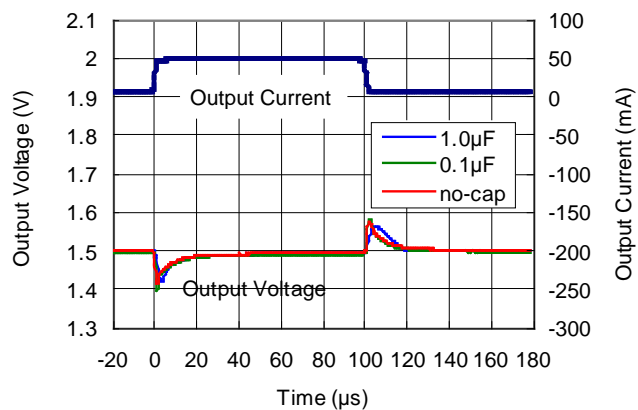

RP107x151x

Tr=Tf: 0.5μs
Iout : 50mA ⇄ 100mA

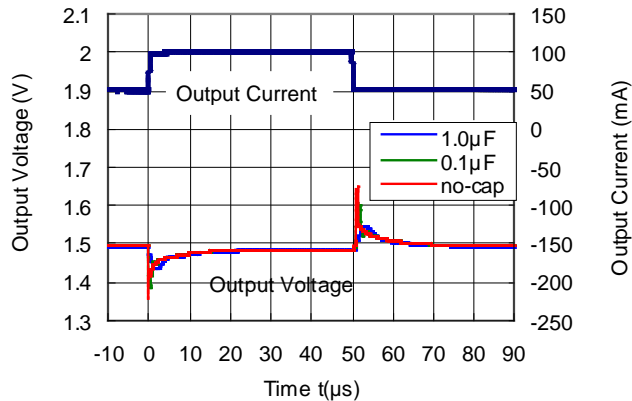

*RP107N (SOT-23-5) is the Discontinued product. As of March in 2019.

RP107x

NO.EA-181-170424

RP107x281x

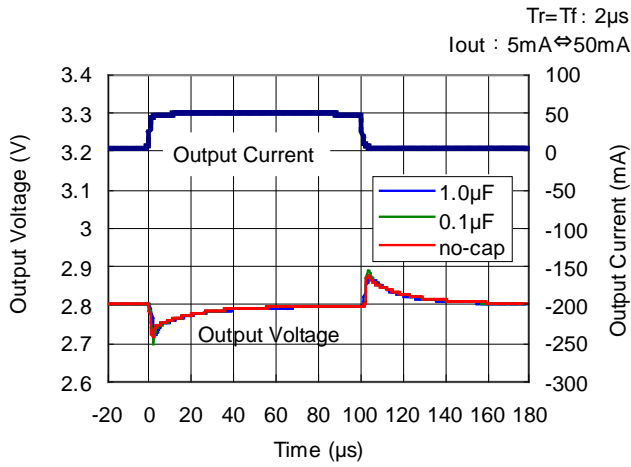

RP107x281x

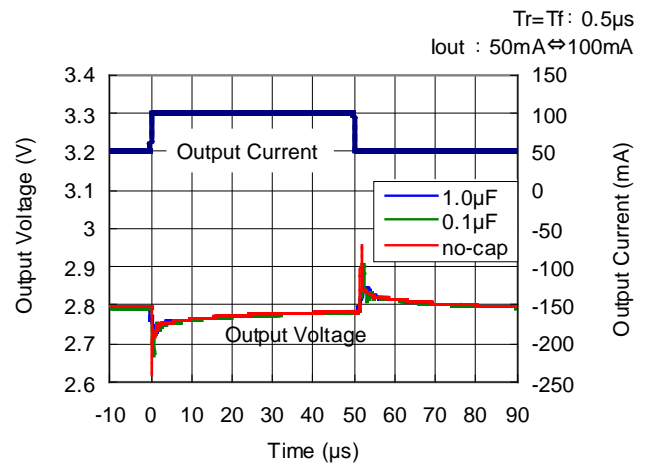

RP107x421x

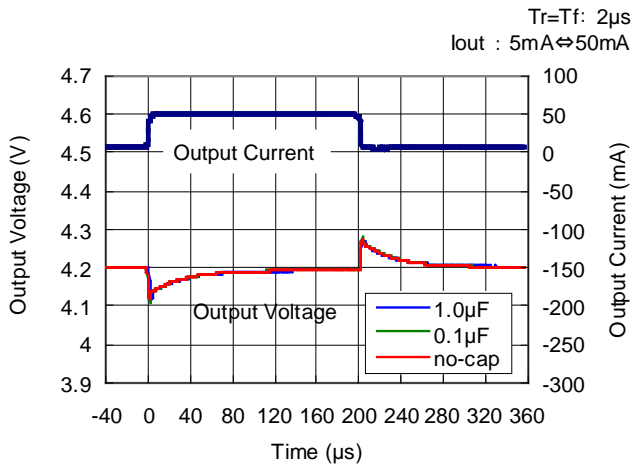

RP107x421x

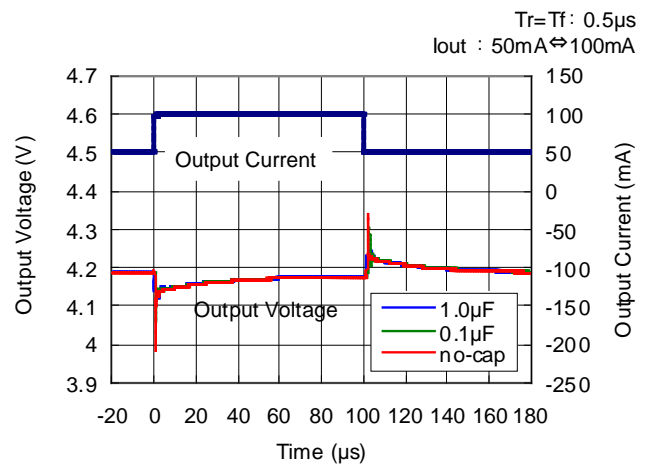

13) Turn On Speed with CE pin (C_{IN}=0.1µF, T_{opt}=25°C)

RP107x101x

V_{in}=2.0V

C_{out}=none

V_{in}=2.5V

C_{out}=none

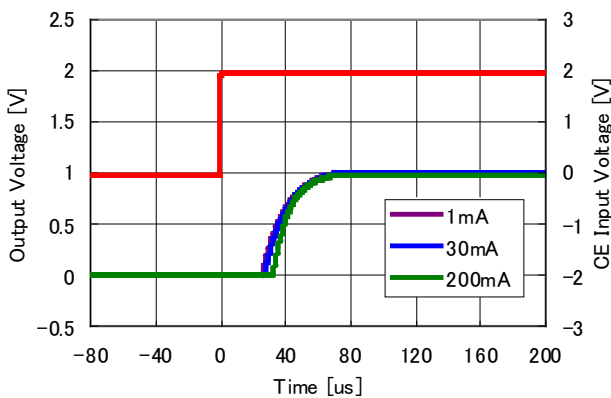

RP107x151x

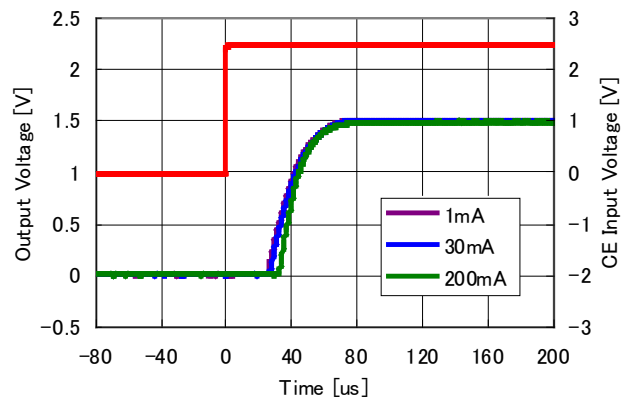

*RP107N (SOT-23-5) is the Discontinued product. As of March in 2019.

RP107x

NO.EA-181-170424

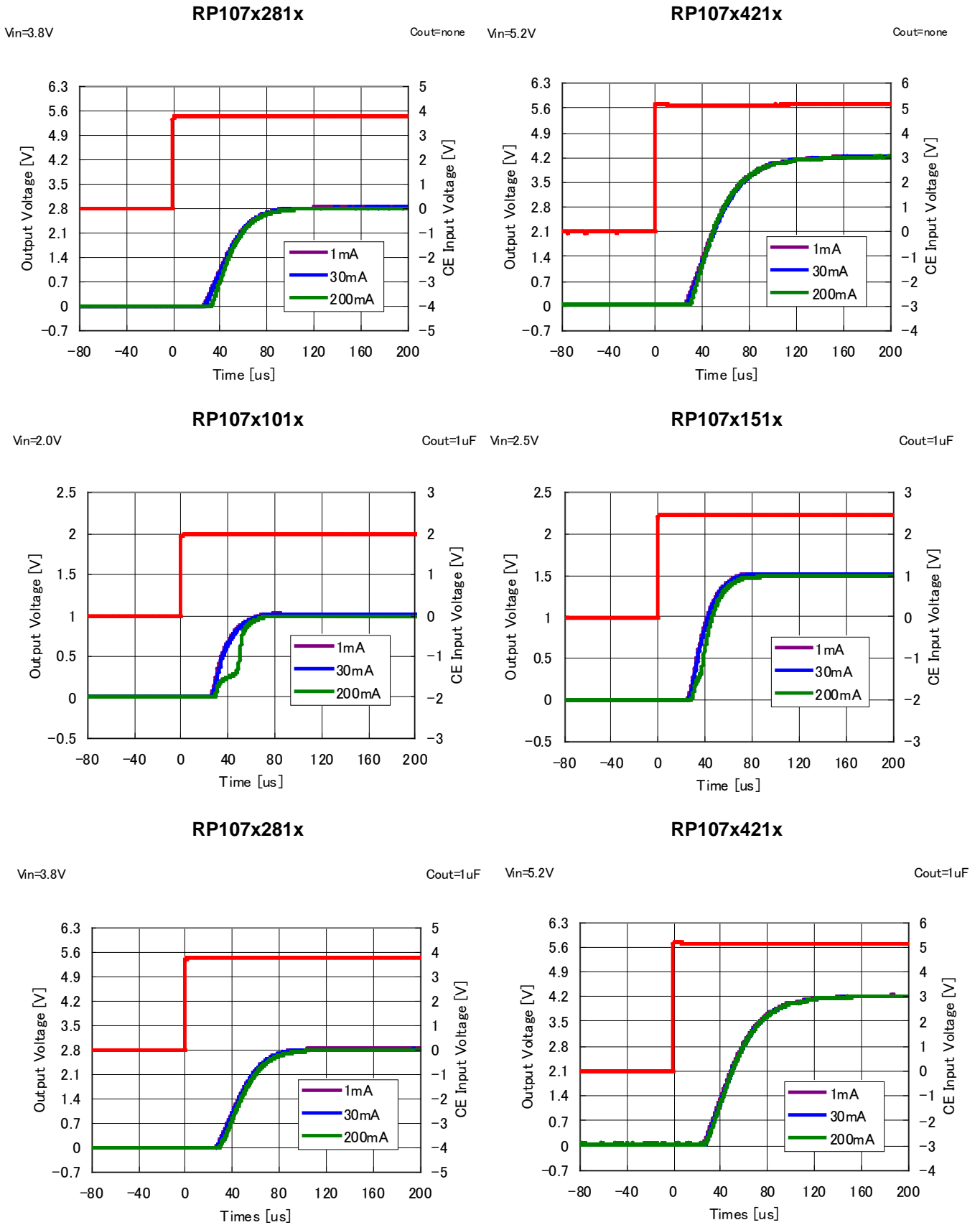

*RP107N (SOT-23-5) is the Discontinued product. As of March in 2019.

RP107x

NO.EA-181-170424

14) Turn Off Speed with CE pin (D Version) ($C_{IN}=0.1\mu F$, $T_{opt}=25^{\circ}C$)

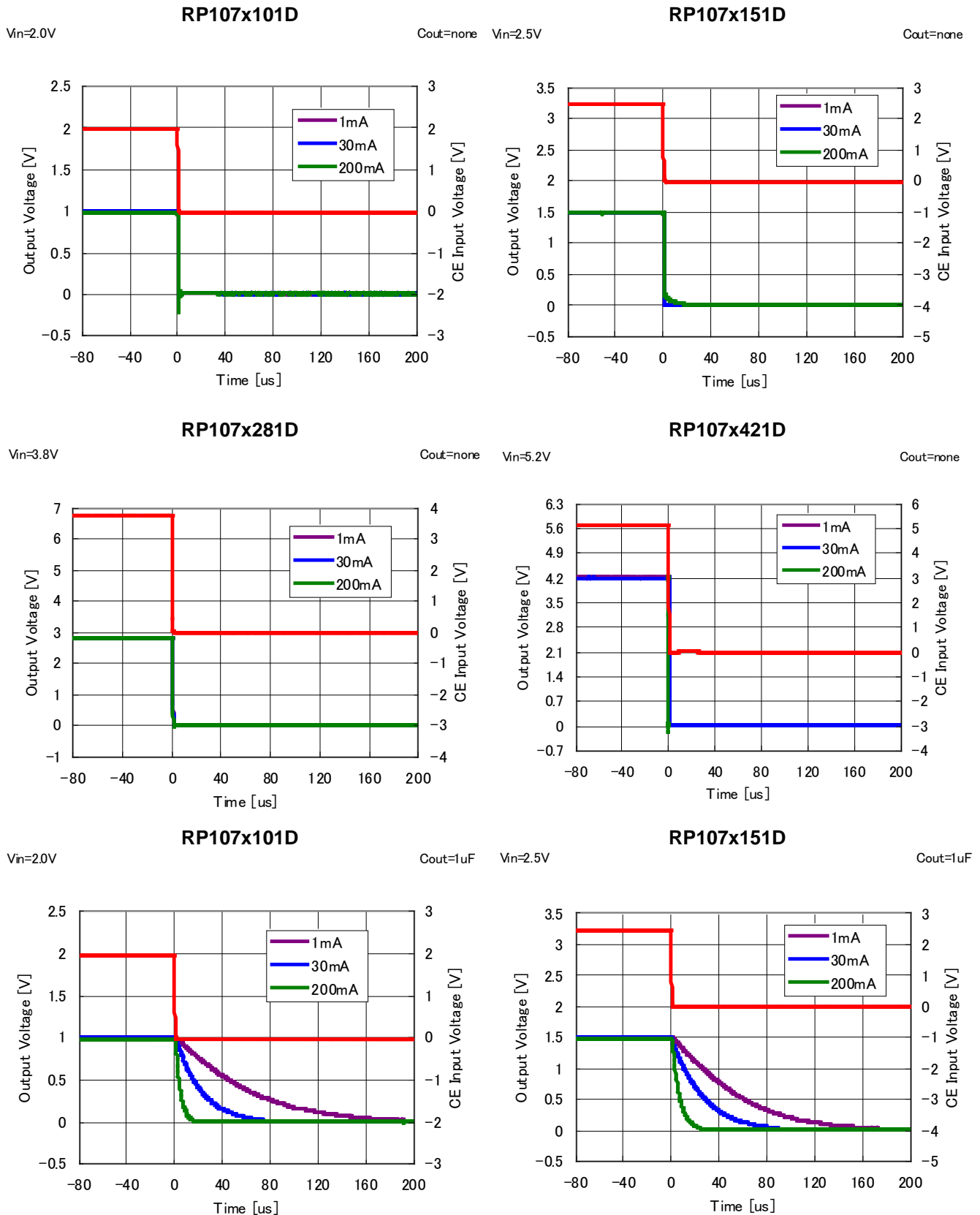

*RP107N (SOT-23-5) is the Discontinued product. As of March in 2019.

RP107x

NO.EA-181-170424

RP107x281D

V_{in}=3.8V

C_{out}=1μF

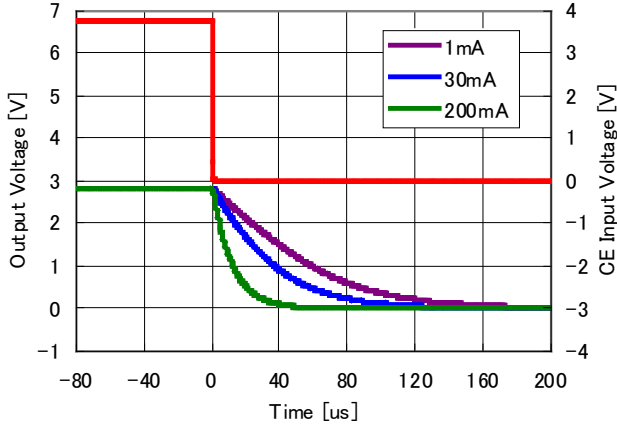

RP107x421D

V_{in}=5.2V

C_{out}=1μF

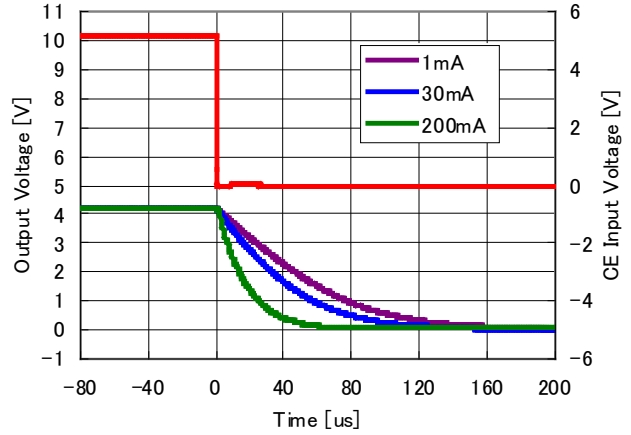

15) Inrush Current (C_{IN}=0.1μF, T_{opt}=25°C)

RP107x101x

V_{IN}=2.0V
C_{OUT}=none

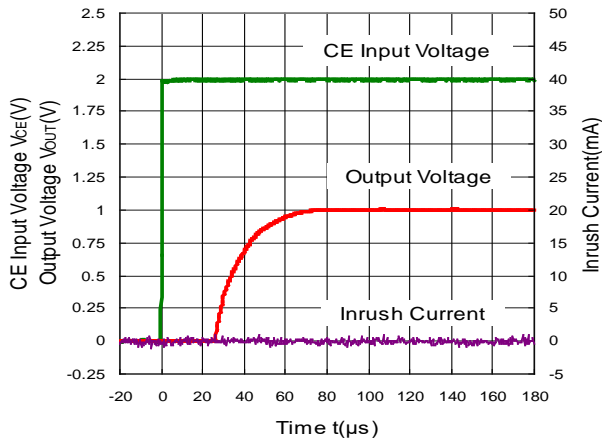

RP107x101x

V_{IN}=2.0V
C_{OUT}=Ceramic1.0μF

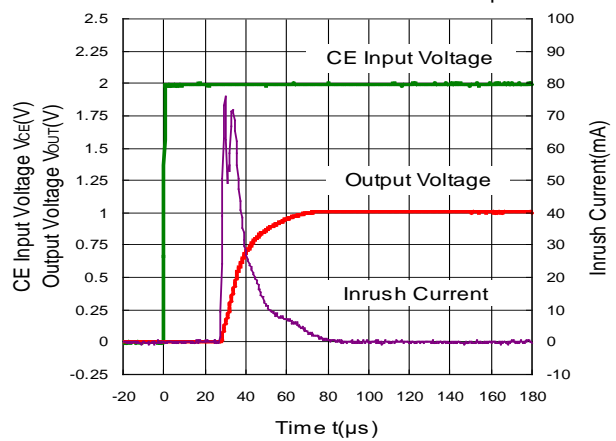

RP107x101x

V_{IN}=2.0V
C_{OUT}=Ceramic4.7μF

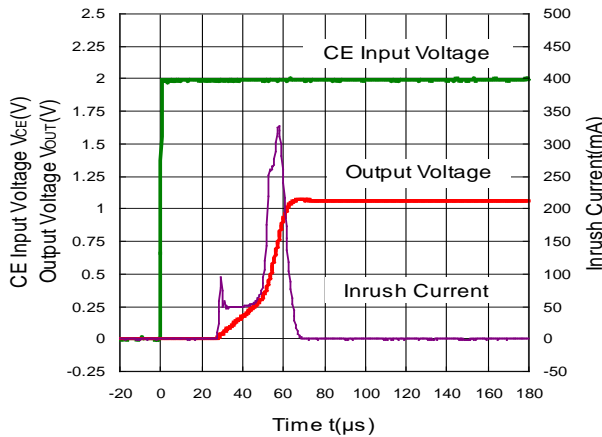

RP107x281x

V_{IN}=3.8V
C_{OUT}=none

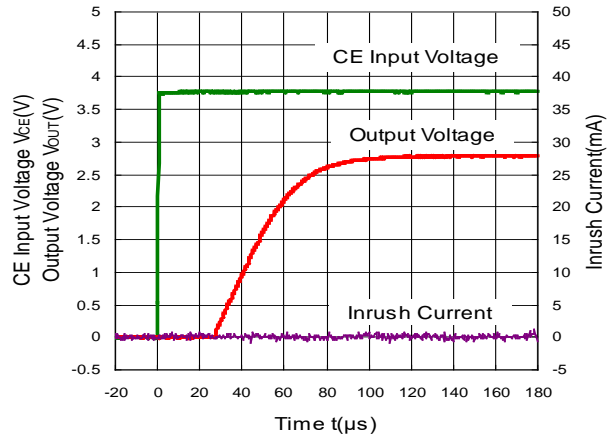

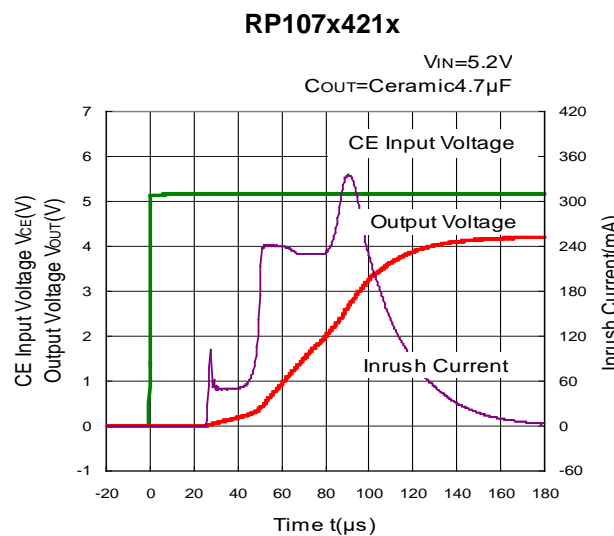
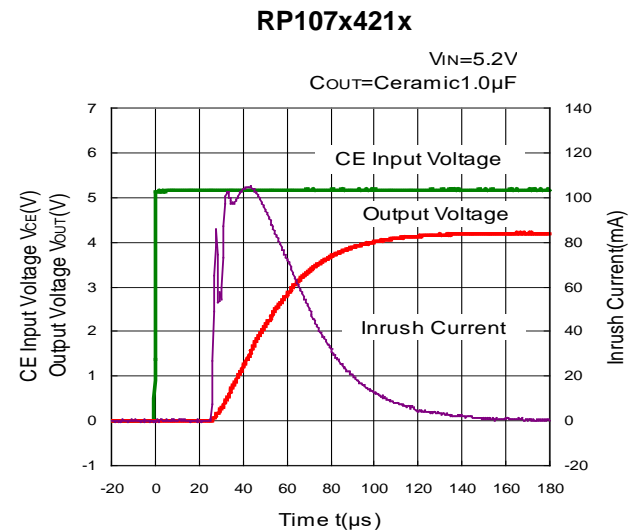
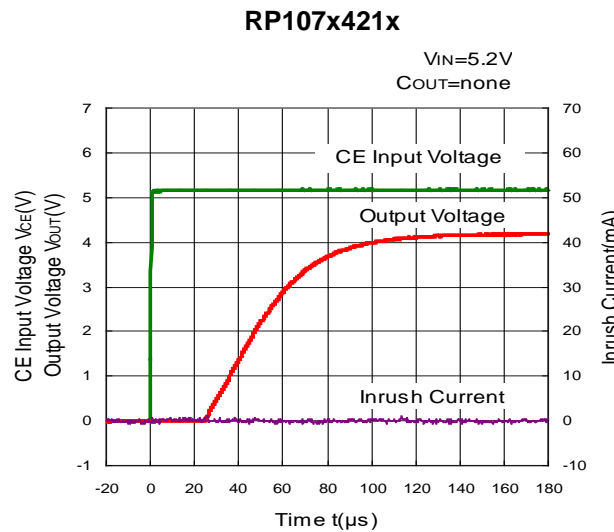
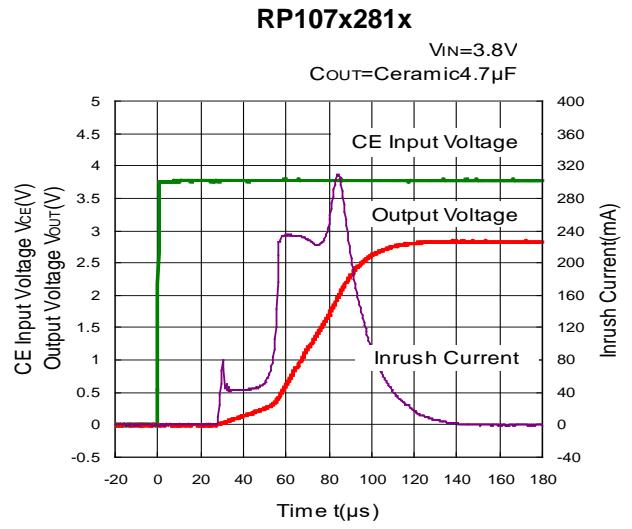
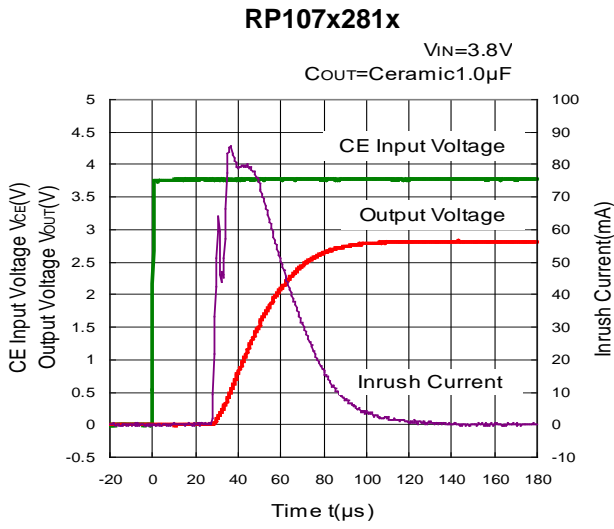

RP107x

NO.EA-181-170424

ESR vs. Output Current

When using these ICs, consider the following points:

The relations between I_{OUT} (Output Current) and ESR of an output capacitor are shown below.

The conditions when the white noise level is under $40\mu\text{V}$ (Avg.) are marked as the hatched area in the graph.

Measurement conditions

Frequency Band : 10Hz to 2MHz

Temperature : -40°C to 85°C

C_{IN}, C_{OUT} : Ceramic $0.1\mu\text{F}$

RP107x101x

$V_{in}=1.0\text{V}\sim 5.25\text{V}$

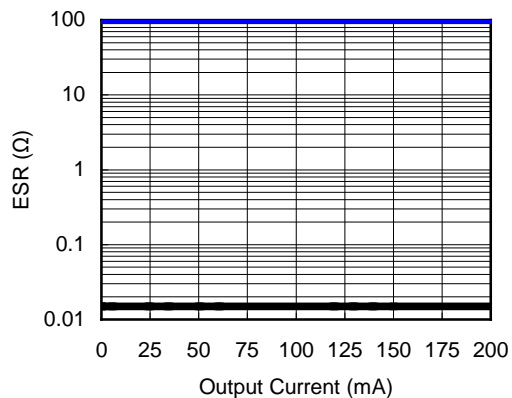

RP107x281x

$V_{in}=1.0\text{V}\sim 5.25\text{V}$

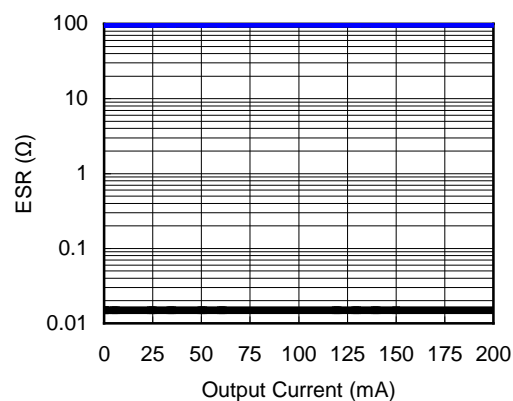

RP107x421x

$V_{in}=1.0\text{V}\sim 5.25\text{V}$

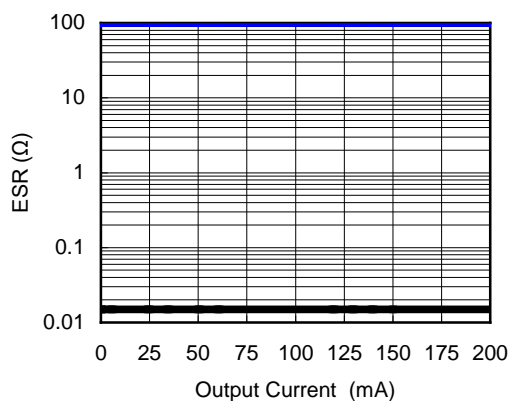



1. The products and the product specifications described in this document are subject to change or discontinuation of production without notice for reasons such as improvement. Therefore, before deciding to use the products, please refer to Ricoh sales representatives for the latest information thereon.
2. The materials in this document may not be copied or otherwise reproduced in whole or in part without prior written consent of Ricoh.
3. Please be sure to take any necessary formalities under relevant laws or regulations before exporting or otherwise taking out of your country the products or the technical information described herein.
4. The technical information described in this document shows typical characteristics of and example application circuits for the products. The release of such information is not to be construed as a warranty of or a grant of license under Ricoh's or any third party's intellectual property rights or any other rights.
5. The products listed in this document are intended and designed for use as general electronic components in standard applications (office equipment, telecommunication equipment, measuring instruments, consumer electronic products, amusement equipment etc.). Those customers intending to use a product in an application requiring extreme quality and reliability, for example, in a highly specific application where the failure or misoperation of the product could result in human injury or death (aircraft, spacevehicle, nuclear reactor control system, traffic control system, automotive and transportation equipment, combustion equipment, safety devices, life support system etc.) should first contact us.
6. We are making our continuous effort to improve the quality and reliability of our products, but semiconductor products are likely to fail with certain probability. In order to prevent any injury to persons or damages to property resulting from such failure, customers should be careful enough to incorporate safety measures in their design, such as redundancy feature, fire containment feature and fail-safe feature. We do not assume any liability or responsibility for any loss or damage arising from misuse or inappropriate use of the products.
7. Anti-radiation design is not implemented in the products described in this document.
8. The X-ray exposure can influence functions and characteristics of the products. Confirm the product functions and characteristics in the evaluation stage.
9. WLCSP products should be used in light shielded environments. The light exposure can influence functions and characteristics of the products under operation or storage.
10. There can be variation in the marking when different AOI (Automated Optical Inspection) equipment is used. In the case of recognizing the marking characteristic with AOI, please contact Ricoh sales or our distributor before attempting to use AOI.
11. Please contact Ricoh sales representatives should you have any questions or comments concerning the products or the technical information.



Ricoh is committed to reducing the environmental loading materials in electrical devices with a view to contributing to the protection of human health and the environment.

Ricoh has been providing RoHS compliant products since April 1, 2006 and Halogen-free products since April 1, 2012.

RICOH RICOH ELECTRONIC DEVICES CO., LTD.

<https://www.e-devices.ricoh.co.jp/en/>

Sales & Support Offices

Ricoh Electronic Devices Co., Ltd.

Shin-Yokohama Office (International Sales)

2-3, Shin-Yokohama 3-chome, Kohoku-ku, Yokohama-shi, Kanagawa, 222-8530, Japan
Phone: +81-50-3814-7687 Fax: +81-45-474-0074

Ricoh Americas Holdings, Inc.

675 Campbell Technology Parkway, Suite 200 Campbell, CA 95008, U.S.A.
Phone: +1-408-610-3105

Ricoh Europe (Netherlands) B.V.

Semiconductor Support Centre

Prof. W.H. Keesomlaan 1, 1183 DJ Amstelveen, The Netherlands
Phone: +31-20-5474-309

Ricoh International B.V. - German Branch

Semiconductor Sales and Support Centre

Oberrather Strasse 6, 40472 Düsseldorf, Germany
Phone: +49-211-6546-0

Ricoh Electronic Devices Korea Co., Ltd.

3F, Haesung Bldg, 504, Teheran-ro, Gangnam-gu, Seoul, 135-725, Korea
Phone: +82-2-2135-5700 Fax: +82-2-2051-5713

Ricoh Electronic Devices Shanghai Co., Ltd.

Room 403, No.2 Building, No.690 Bibo Road, Pu Dong New District, Shanghai 201203,
People's Republic of China
Phone: +86-21-5027-3200 Fax: +86-21-5027-3299

Ricoh Electronic Devices Shanghai Co., Ltd.

Shenzhen Branch

1205, Block D (Jinlong Building), Kingkey 100, Hongbao Road, Luohu District,
Shenzhen, China
Phone: +86-755-8348-7600 Ext 225

Ricoh Electronic Devices Co., Ltd.

Taipei office

Room 109, 10F-1, No.51, Hengyang Rd., Taipei City, Taiwan
Phone: +886-2-2313-1621/1622 Fax: +886-2-2313-1623