

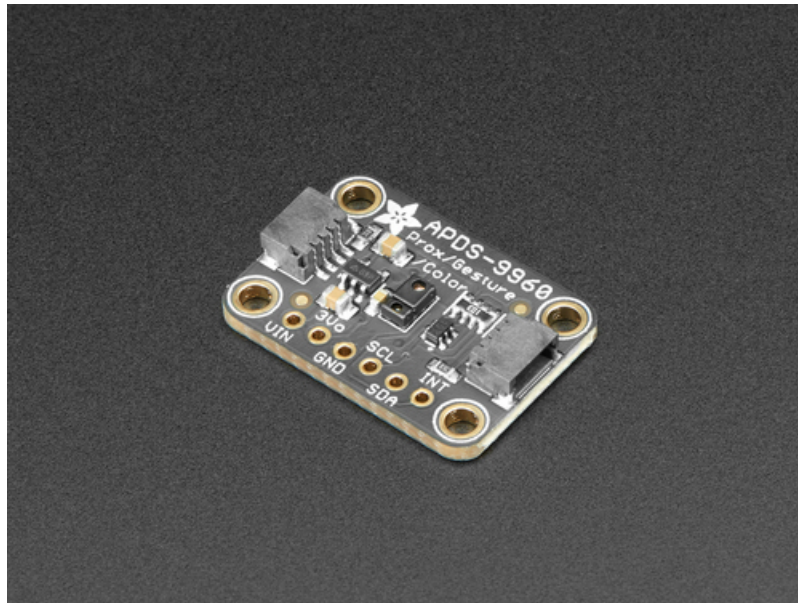

## Adafruit APDS9960 breakout

Created by Justin Cooper



Last updated on 2020-03-26 04:47:18 PM UTC

## Overview

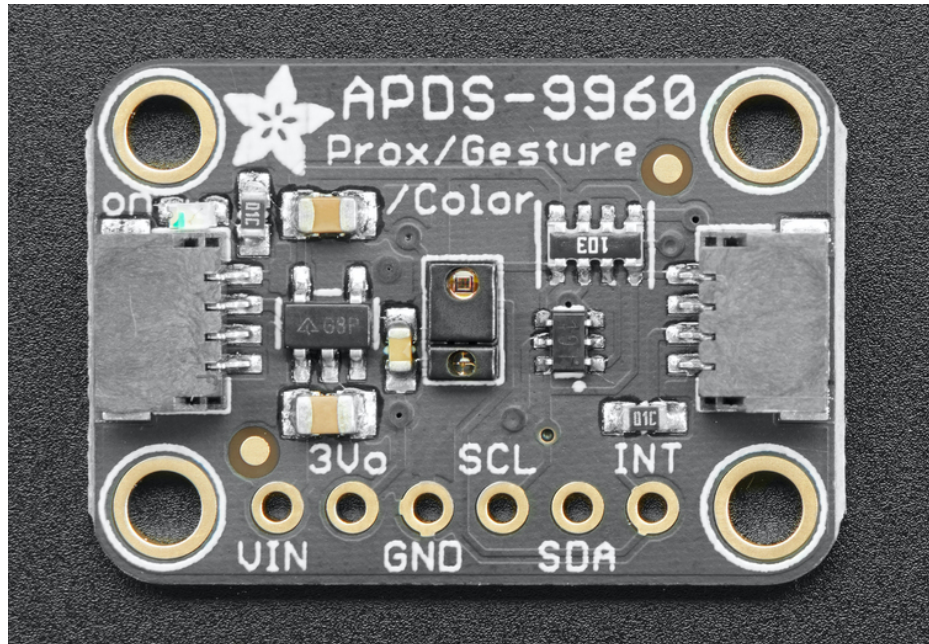

This handy sensor is full of features! Add basic gesture sensing, RGB color sensing, proximity sensing, or ambient light sensing to your project with the **Adafruit APDS9960 Proximity, Light, RGB and Gesture Sensor**. When connected to your microcontroller (running our library code) it can detect simple gestures (left to right, right to left, up to down, down to up are currently supported), return the amount of red, blue, green, and clear light, or return how close an object is to the front of the sensor. This device uses an I2C interface so it's easy to wire up and use.

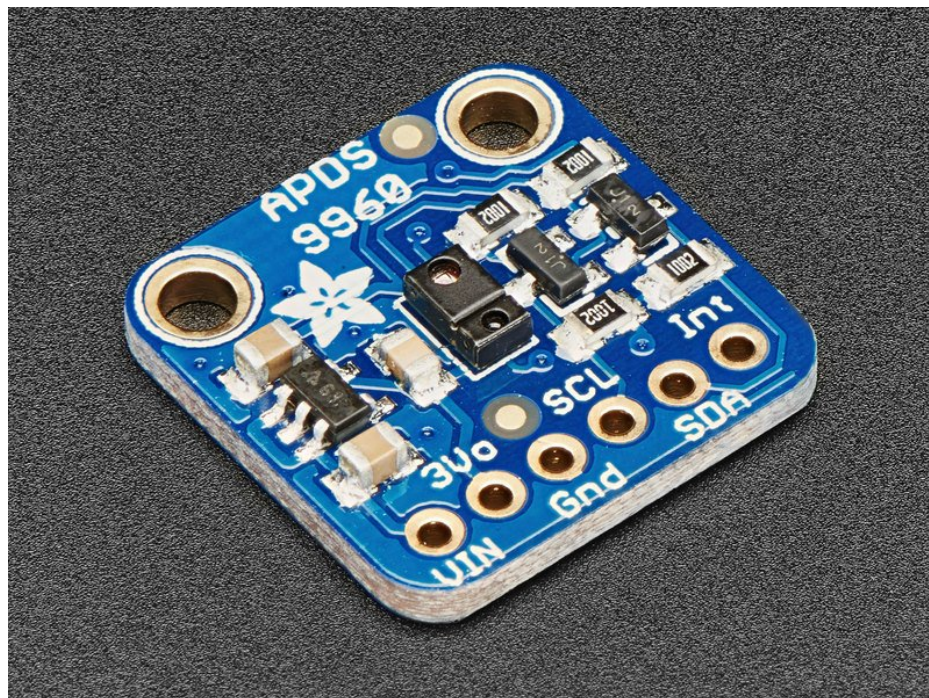

**New!** We've updated this board to be **STEMMA QT** compatible. We've now included [SparkFun qwiic \(https://adafru.it/Fpw\)](https://adafru.it/Fpw) compatible **STEMMA QT (https://adafru.it/Ft4)** connectors for the I2C bus so you don't

even need to solder! Just wire up to your favorite microcontroller or computer with a plug-and-play QT cable (<https://adafru.it/JRA>) to light/color/proximity data ASAP.

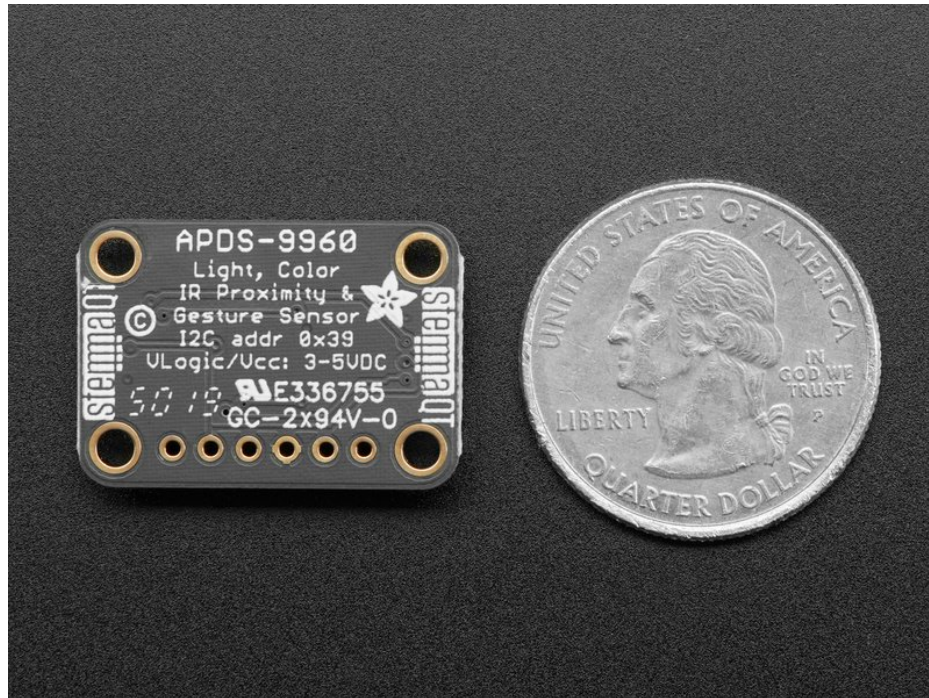

The APDS9960 from Avago Technologies has an integrated IR LED and driver, along with four directional photodiodes that sense reflected IR energy from the LED. It's proximity detection feature allows it to measure the distance an object is from the front of the sensor (up to a few centimeters) with 8 bit resolution.

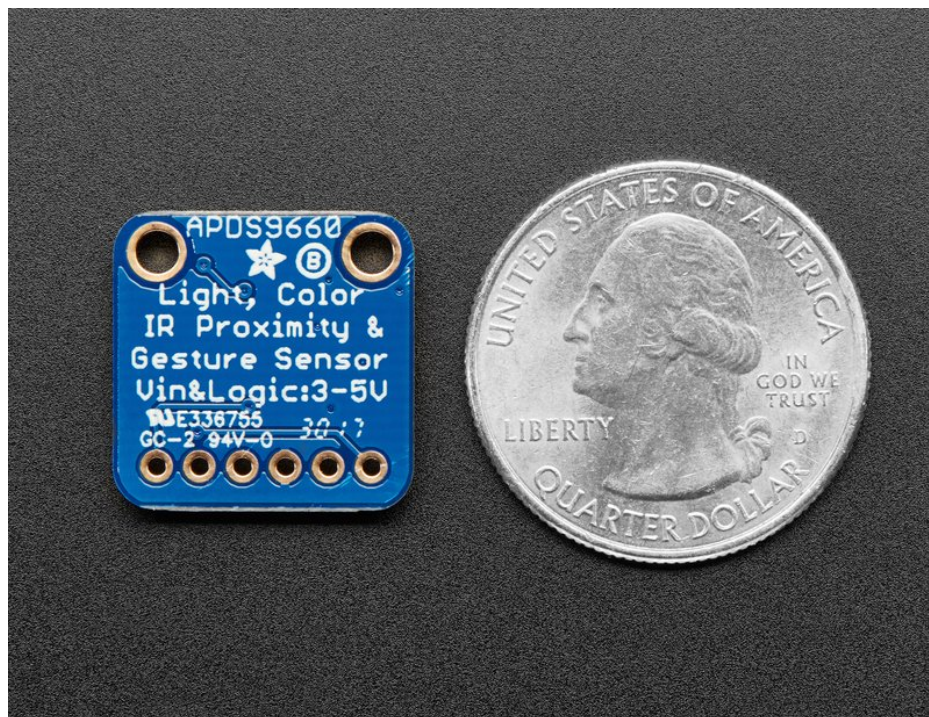

Since there are four IR sensors, you can measure the changes in light reflectance at each of the cardinal locations over time and turn those changes into gestures. Our interface library can detect directional gestures (left to right, right to

left, up to down, down to up), but in theory more complicated gestures like zig-zag, clockwise or counterclockwise circle, near to far, etc. could also be detected with additional code.

The APDS9960 has a configurable interrupt that can fire when a certain proximity threshold is broken, or when a color sensor breaks a certain threshold.

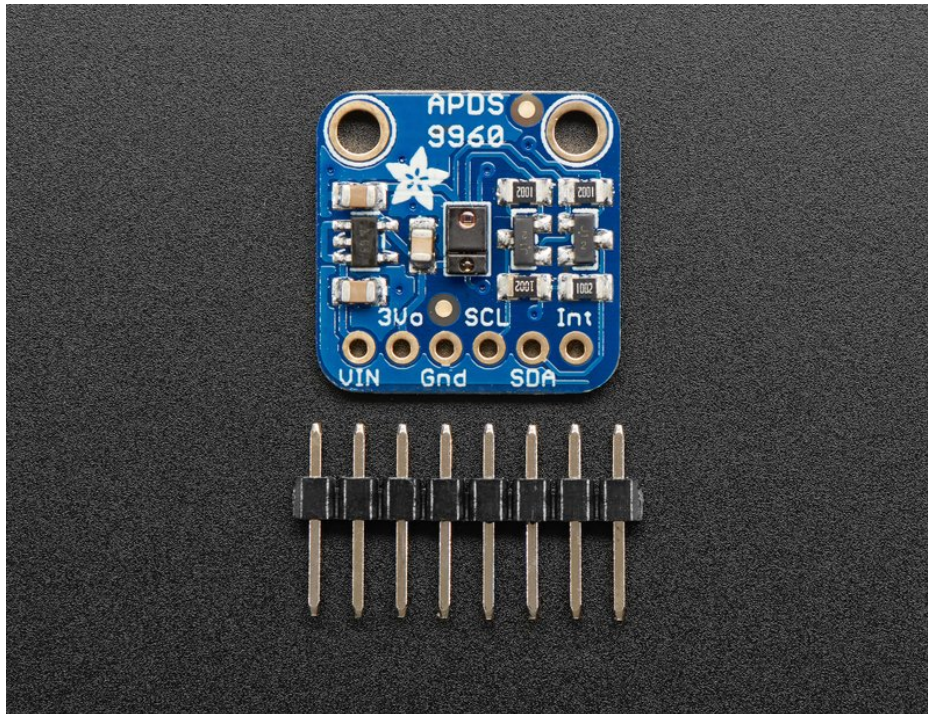

For your convenience we've pick-and-placed the sensor on a PCB with a 3.3V regulator and some level shifting so it can be easily used with your favorite 3.3V or 5V microcontroller.

We've also prepared software libraries to get you up and running in Arduino with just a few lines of code!

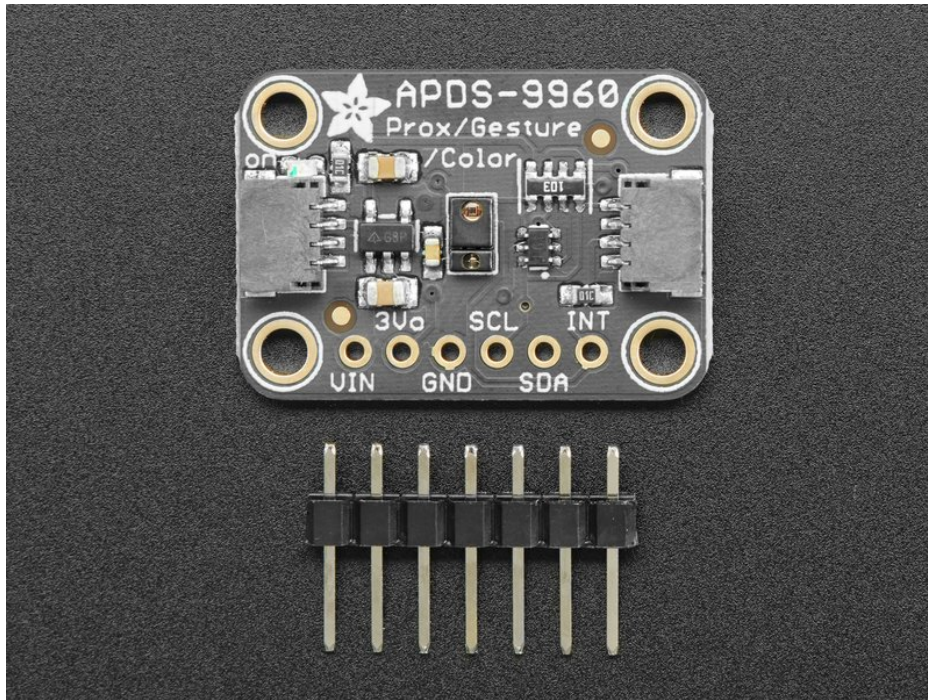

## Pinouts

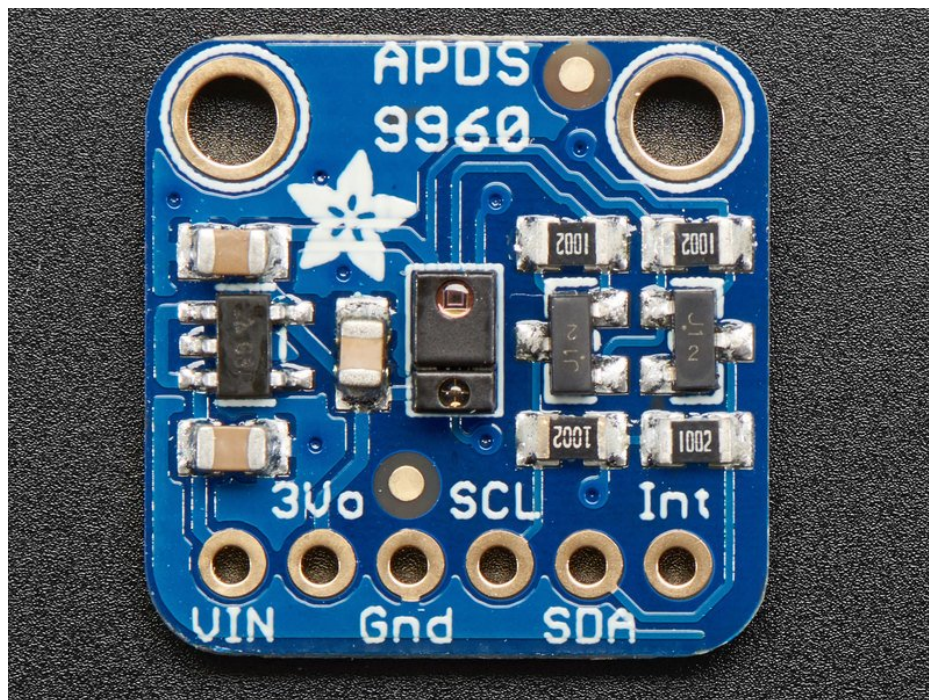
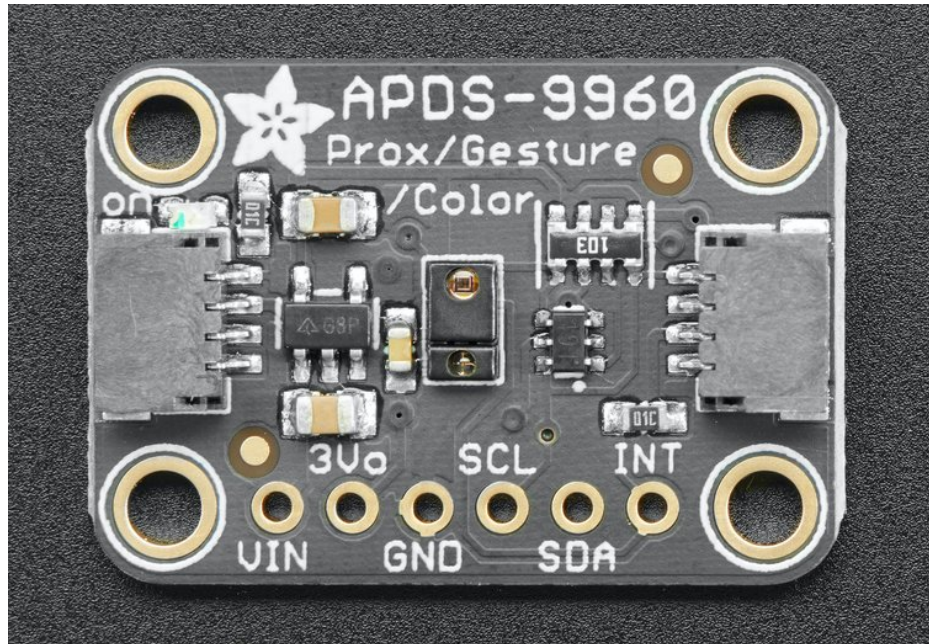

### Power Pins:

- **Vin** - this is the power pin. Since the sensor uses 3.3V, we have included an onboard voltage regulator that will take 3-5VDC and safely convert it down. To power the board, give it the same power as the logic level of your microcontroller - e.g. for a 5V micro like Arduino, use 5V
- **3Vo** - this is the 3.3V output from the voltage regulator, you can grab up to 100mA from this if you like
- **GND** - common ground for power and logic

## Logic pins:

- **SCL** - this is the I2C clock pin, connect to your microcontrollers I2C clock line. There is a 10K pullup on this pin and it is level shifted so you can use 3 - 5VDC.
- **SDA** - this is the I2C data pin, connect to your microcontrollers I2C data line. There is a 10K pullup on this pin and it is level shifted so you can use 3 - 5VDC.
- **INT** - this is the interrupt-output pin. It is 3V logic and you can use it to detect when a new reading is ready or when a reading gets too high or too low.
- **STEMMA QT** (<https://adafru.it/Ft4>) - These connectors allow you to connect to dev boards with **STEMMA QT** connectors or to other things with **various associated accessories** (<https://adafru.it/Ft6>)

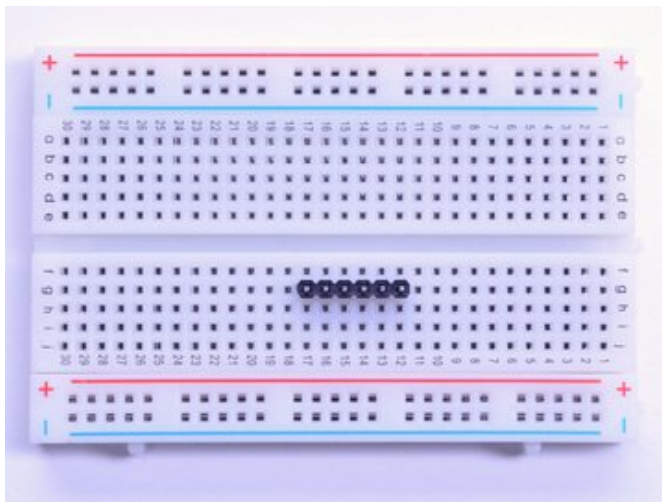
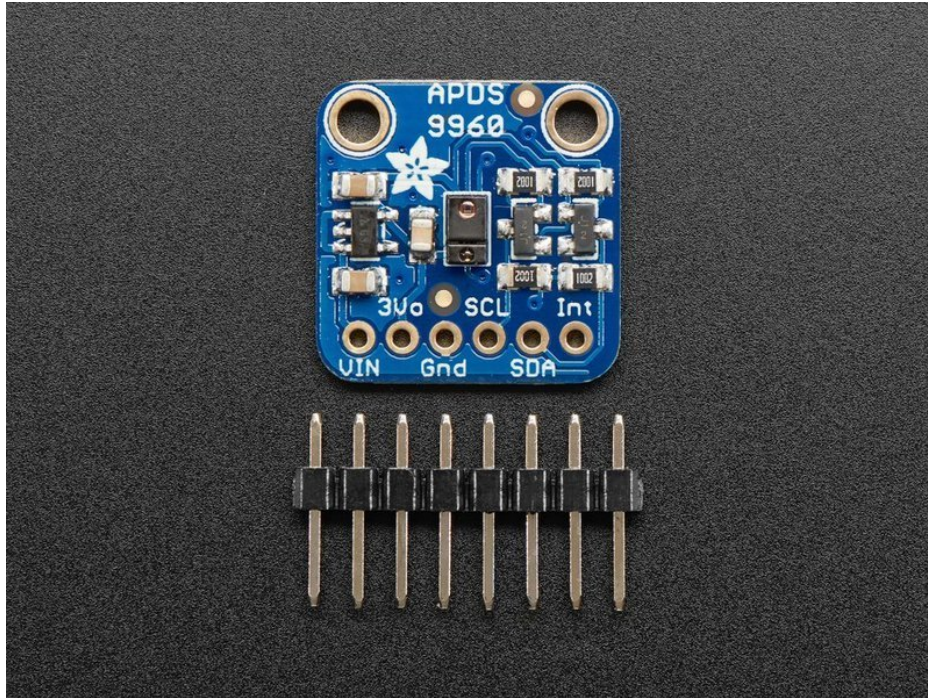

Prepare the header strip:  
Cut the strip to length if necessary. It will be easier to solder if you insert it into a breadboard - **long pins down**



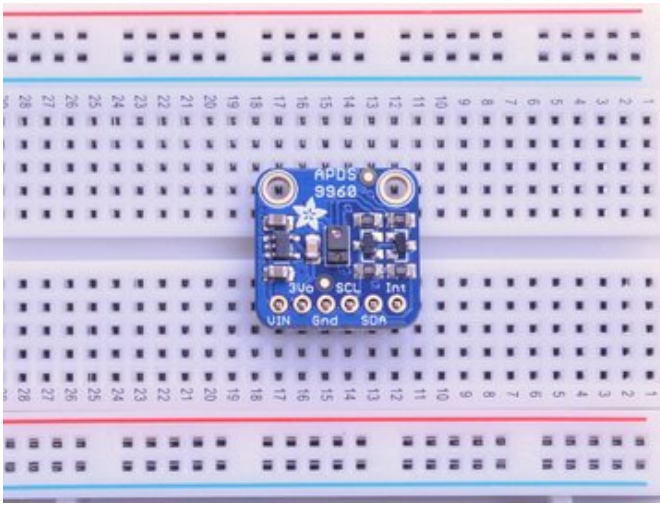

Add the breakout board:  
Place the breakout board over the pins so that the short pins poke through the breakout pads

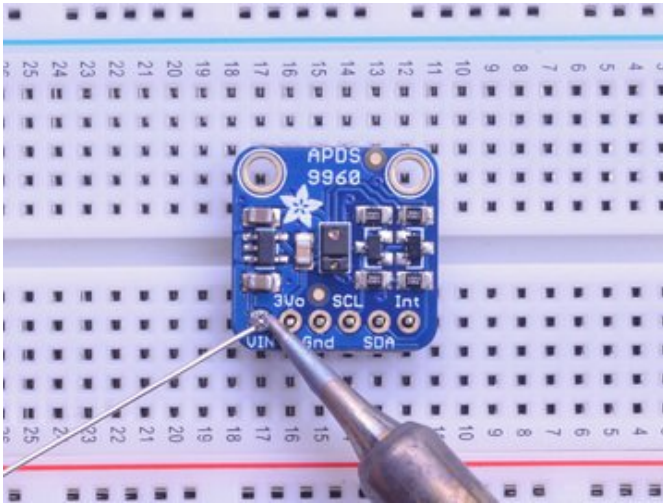

And Solder!

Be sure to solder all 6 pins for reliable electrical contact.

*(For tips on soldering, be sure to check out our [Guide to Excellent Soldering](https://adafruit.it/aTk) (<https://adafruit.it/aTk>)).*

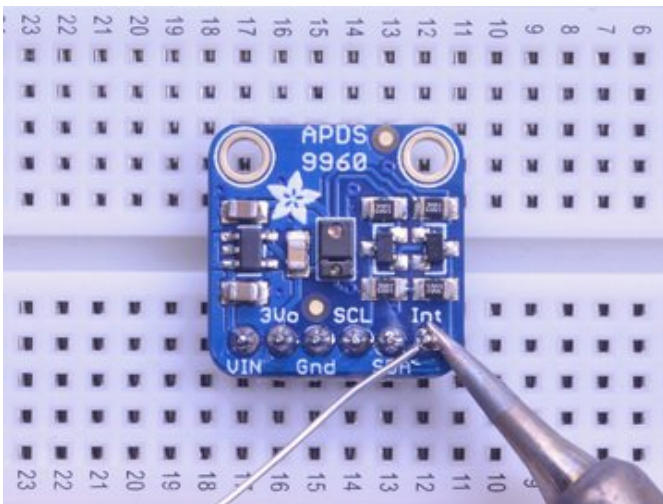
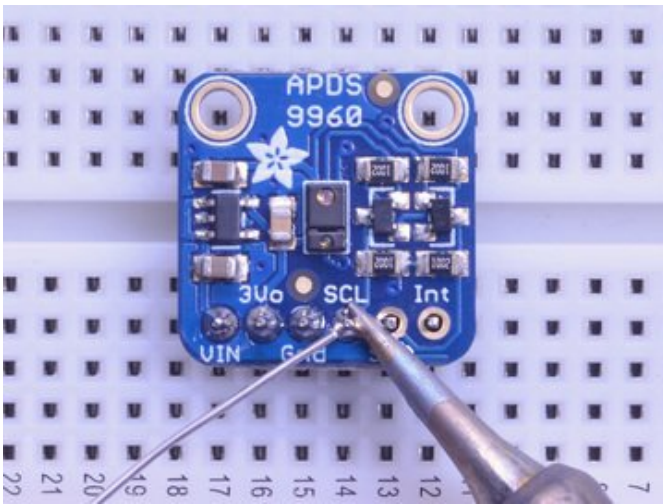

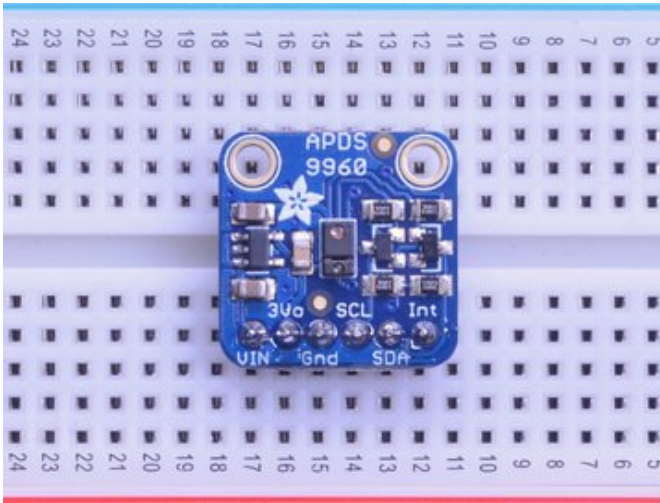

You're done! Check your solder joints visually and continue onto the next steps

## Arduino Wiring & Test

You can easily wire this breakout to any microcontroller, we'll be using an Adafruit Metro (Arduino compatible) with the Arduino IDE. But, you can use any other kind of microcontroller as well as long as it has I2C clock and I2C data lines.

Note this chip uses address **0x39** and that you cannot change addresses!

### I2C Wiring

- Connect **Vin** to the power supply, 3-5V is fine. Use the same voltage that the microcontroller logic is based off of. For most Arduinos, that is 5V
- Connect **GND** to common power/data ground
- Connect the **SCL** pin to the I2C clock **SCL** pin on your Arduino.  
On an UNO & '328 based Arduino, this is also known as **A5**, on a Mega it is also known as **digital 21** and on a Leonardo/Micro, **digital 3**
- Connect the **SDA** pin to the I2C data **SDA** pin on your Arduino.  
On an UNO & '328 based Arduino, this is also known as **A4**, on a Mega it is also known as **digital 20** and on a Leonardo/Micro, **digital 2**

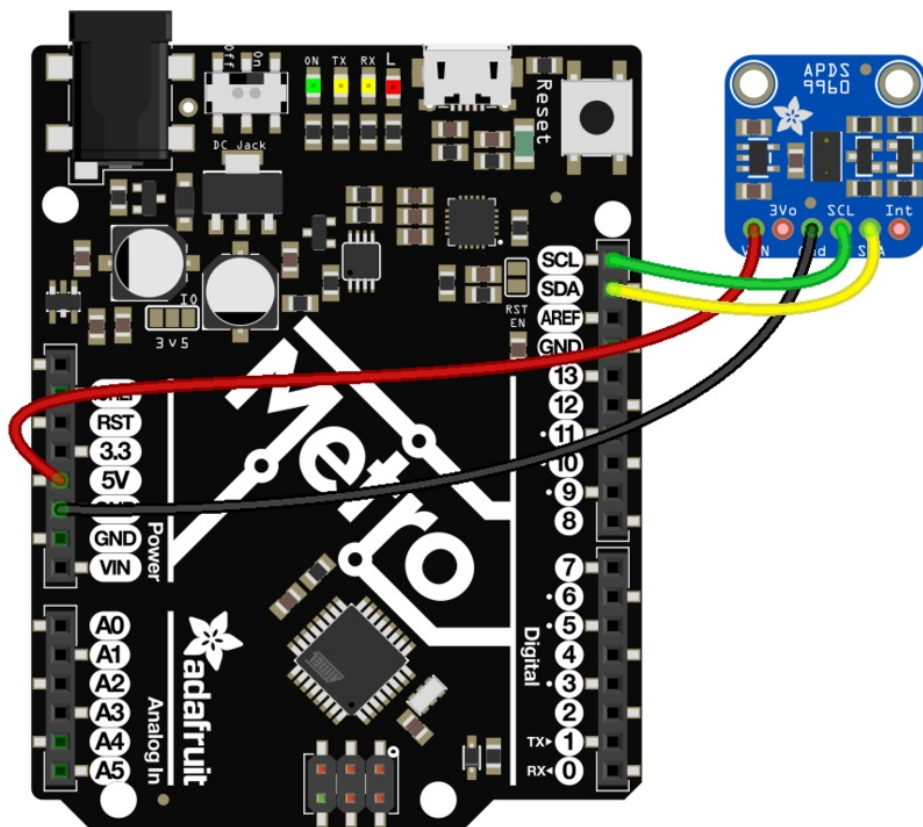

fritzing

<https://adafru.it/zOf>

<https://adafru.it/zOf>

## Download Adafruit\_APDS9960 library

To begin reading sensor data, you will need to download Adafruit\_APDS9960 from the Arduino library manager.

Open up the Arduino library manager:

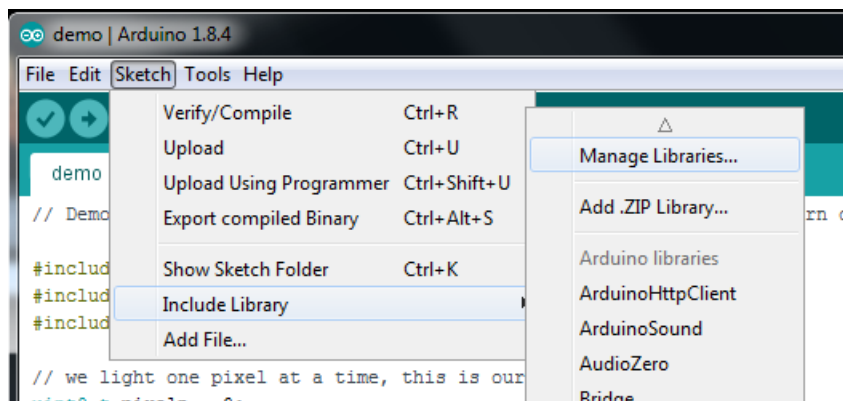

Search for the **Adafruit APDS9960** library and install it

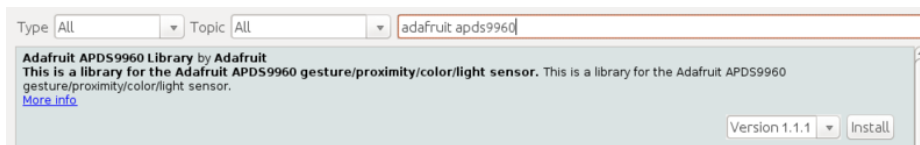

We also have a great tutorial on Arduino library installation at:

<http://learn.adafruit.com/adafruit-all-about-arduino-libraries-install-use> (<https://adafru.it/aYM>)

## Load Gesture Sensor Example

Open up **File->Examples->Adafruit\_APDS9960->gesture\_sensor** and upload the code to your microcontroller wired up to the sensor. This example connects to the sensor and starts interpreting gestures.

Once uploaded to your Arduino, open up the serial console at 115200 baud speed. Put your hand close to the front of the sensor to activate gesture mode. Then make your directional gestures 3 or 4 inches from the sensor. You should see directional arrows appear in the serial console corresponding to the gesture you've made.



make sure to put your hand close (a few centimeters) to the sensor first to enable gesture mode before making gestures.

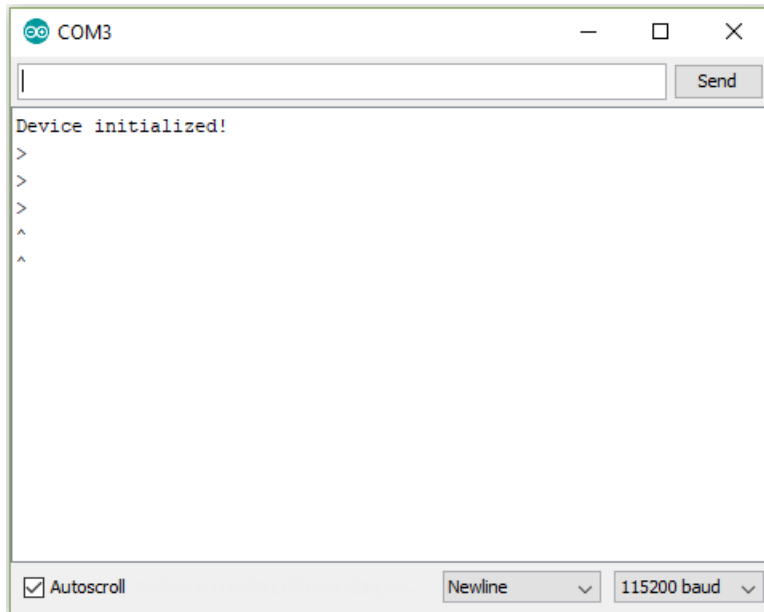

## Python & CircuitPython

It's easy to use the APDS9960 sensor with CircuitPython or Python and the [Adafruit CircuitPython APDS9960](https://adafruit.com/product/242) (<https://adafru.it/BrN>) module. This module allows you to easily write Python code that reads the proximity and other readings from the sensor.

You can use this sensor with any CircuitPython microcontroller board or with a computer that has GPIO and Python thanks to [Adafruit\\_Blinka](https://adafruit.com/product/242), our [CircuitPython-for-Python compatibility library](https://adafru.it/BSN) (<https://adafru.it/BSN>).

### CircuitPython Microcontroller Wiring

First wire up a APDS9960 breakout to your board exactly as shown below. Here's an example of wiring a Feather M4 to the sensor with I2C:

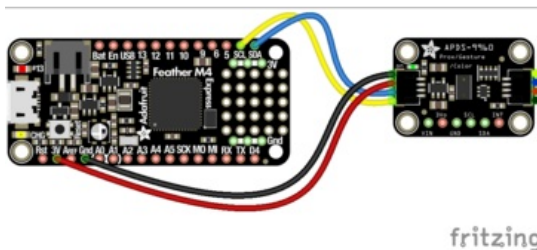

- Board GND to sensor GND (black wire)
- Board 3V to sensor VIN (red wire)
- Board SDA to sensor SDA (blue wire)
- Board SCL to sensor SCL (yellow wire)

Or you can wire up the APDS9960 to your board exactly as shown on the previous pages for Arduino using an I2C connection. Here's an example of wiring a Feather M0 to the sensor with I2C:

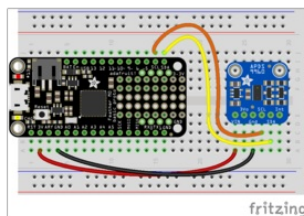

- Board 3V to sensor VIN
- Board GND to sensor GND
- Board SCL to sensor SCL
- Board SDA to sensor SDA

### Python Computer Wiring

Since there's *dozens* of Linux computers/boards you can use we will show wiring for Raspberry Pi. For other platforms, please visit the [guide for CircuitPython on Linux](https://adafruit.com/product/242) to see whether your platform is supported (<https://adafru.it/BSN>).

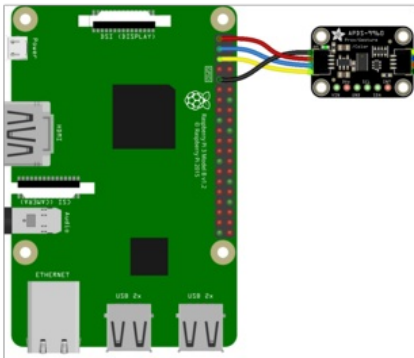

- Pi GND to sensor GND (black wire)
- Pi 3V3 to sensor VIN (red wire)
- Pi SDA to sensor SDA (blue wire)
- Pi SCL to sensor SCL (yellow wire)

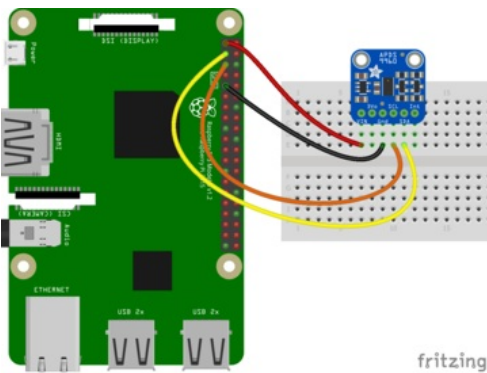

- Pi 3V3 to sensor VIN
- Pi GND to sensor GND
- Pi SCL to sensor SCL
- Pi SDA to sensor SDA

## CircuitPython Installation of APDS9960 Library

Next you'll need to install the [Adafruit CircuitPython APDS9960 \(https://adafruit.it/BrN\)](https://adafruit.it/BrN) library on your CircuitPython board.

First make sure you are running the [latest version of Adafruit CircuitPython \(https://adafruit.it/Amd\)](https://adafruit.it/Amd) for your board.

Next you'll need to install the necessary libraries to use the hardware--carefully follow the steps to find and install these libraries from [Adafruit's CircuitPython library bundle \(https://adafruit.it/zdx\)](https://adafruit.it/zdx). Our introduction guide has [a great page on how to install the library bundle \(https://adafruit.it/ABU\)](https://adafruit.it/ABU) for both express and non-express boards.

Remember for non-express boards like the, you'll need to manually install the necessary libraries from the bundle:

- `adafruit_apds9960`
- `adafruit_bus_device`
- `adafruit_register`

You can also download the `adafruit_apds9960` folder from [its releases page on Github \(https://adafruit.it/BrO\)](https://adafruit.it/BrO).

Before continuing make sure your board's lib folder or root filesystem has the `adafruit_apds9960`, `adafruit_bus_device`, `adafruit_register` folders copied over.

Next [connect to the board's serial REPL \(https://adafruit.it/Awz\)](https://adafruit.it/Awz) so you are at the CircuitPython `>>>` prompt.

## Python Installation of APDS9960 Library



You'll need to install the Adafruit\_Blinka library that provides the CircuitPython support in Python. This may also require enabling I2C on your platform and verifying you are running Python 3. Since each platform is a little different, and Linux changes often, please visit the [CircuitPython on Linux guide](https://adafru.it/BSN) to get your computer ready (<https://adafru.it/BSN>)!

Once that's done, from your command line run the following command:

- `sudo pip3 install adafruit-circuitpython-apds9960`

If your default Python is version 3 you may need to run 'pip' instead. Just make sure you aren't trying to use CircuitPython on Python 2.x, it isn't supported!

## CircuitPython & Python Usage

---

To demonstrate the usage of the sensor we'll initialize it and read the proximity and more from the board's Python REPL. Run the following code to import the necessary modules to initialize the I2C bus and sensor:

```
import board
import busio
import adafruit_apds9960.apds9960
i2c = busio.I2C(board.SCL, board.SDA)
sensor = adafruit_apds9960.apds9960.APDS9960(i2c)
```

## Proximity Reading

---

To sense proximity you first must enable it:

```
sensor.enable_proximity = True
```

Then call the `proximity()` function to retrieve the currently sensed proximity value. This is a number from 0 to 255 where the higher the number the closer an object is to the sensor. You won't be able to translate this into an absolute value in units like inches or millimeters, you can only see how it changes relative to other values.

```
sensor.proximity()
```

```
>>> sensor.proximity()
229
>>> sensor.proximity()
38
```

## Color Reading

---

In addition to proximity you can also measure the color of an object directly in front of the sensor. Like with proximity you must enable it first:

```
sensor.enable_color = True
```

Then read the `color_data` property to retrieve the red, green, blue, and clear color values as a 4-tuple of 16-bit values:

```
r, g, b, c = sensor.color_data
print('Red: {0}, Green: {1}, Blue: {2}, Clear: {3}'.format(r, g, b, c))
```

```
>>> r, g, b, c = sensor.color_data
>>> print('Red: {0}, Green: {1}, Blue: {2}, Clear: {3}'.format(r, g, b, c))
Red: 6862, Green: 5896, Blue: 4760, Clear: 17325
>>>
```

Remember these are 16-bit values that will range from 0 to 65535. A value of 0 means the minimum amount of color and a value of 65535 is the maximum amount of color.

## Gesture Reading

Finally you can read simple up, down, left, right gestures that are sensed by the chip too. Again first you enable gesture sensing:

```
sensor.enable_gesture = True
```

Now you can call the `gesture()` function to read if a gesture was detected and what gesture it was. However you probably want to call this function over and over until it returns a non-zero value, this way you can 'catch' when a gesture happens and remember it.

Run the following code that will wait in a loop for a gesture to be detected:

```
gesture = sensor.gesture()
while gesture == 0:
    gesture = sensor.gesture()
print('Saw gesture: {0}'.format(gesture))
```

Wave a finger very closely in front of the sensor and you should see the REPL return so you can print out the gesture value.

```
>>> gesture = sensor.gesture()
>>> while gesture == 0:
...     gesture = sensor.gesture()
...
>>> print('Saw gesture: {0}'.format(gesture))
Saw gesture: 2
>>>
```

You can convert the gesture value into its meaning with these numbers:

- 0 = No gesture detected
- 1 = Up gesture detected
- 2 = Down gesture detected
- 3 = Left gesture detected
- 4 = Right gesture detected

That's all there is to using the APDS9960 with CircuitPython!

For a complete example of sensing gesture and printing the direction see the [gesture.py example \(https://adafru.it/JSb\)](https://adafru.it/JSb) from the library (or see [all the examples \(https://adafru.it/BrQ\)](https://adafru.it/BrQ) in the library for more usage). Save this as `main.py` on your board and view the output in the REPL. As you move a finger in front of the sensor it will print out the direction of the gesture!

```
from board import SCL, SDA
import busio
from adafruit_apds9960.apds9960 import APDS9960

i2c = busio.I2C(SCL, SDA)

apds = APDS9960(i2c)
apds.enable_proximity = True
apds.enable_gesture = True

while True:
    gesture = apds.gesture()

    if gesture == 0x01:
        print("up")
    elif gesture == 0x02:
        print("down")
    elif gesture == 0x03:
        print("left")
    elif gesture == 0x04:
        print("right")
```

# Python Docs

Python Docs (<https://adafru.it/C1q>)

Documents

- APDS9960 datasheet (<https://adafru.it/z0c>)
- Adafruit APDS9960 Arduino Library Driver (<https://adafru.it/z0d>)
- Fritzing object in the Adafruit Fritzing library (<https://adafru.it/aP3>)
- STEMMA revision Fritzing object in the Adafruit Fritzing library (<https://adafru.it/JQe>)
- APDS9960 breakout PCB files (EAGLE format) (<https://adafru.it/z0e>)

Schematic

click to enlarge

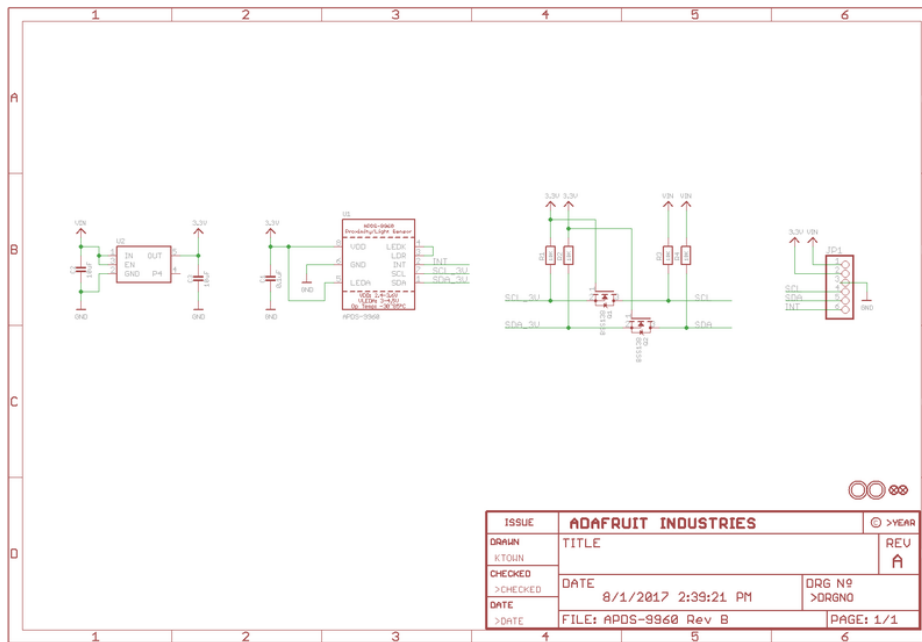

Dimensions

in inches. Click to enlarge

