

## ASM Series • 50/60 Hz Current Sensor

**ASM Series** current sensors operate as the sealed secondary of a current transformer while the conductor carrying the current to be measured functions as a one turn primary. Measurement accuracy can be improved by increasing the number of primary turns. Applications include detection of branch circuit overload and load drop or shutdown.

### Features

- Fully encapsulated for optimal PC board mtg.
- Mains frequency of 50/60 Hz
- Primary current ratings from 1 to 100 Amps
- Primary to secondary isolated to 2500 or 4000VAC
- Operating temperature range: -40° C to +120° C
- Competitive pricing due to high volume production
- Manufactured in an ISO 9001:2015 and ISO 14001:2015 certified Talema facility
- Fully RoHS & REACH Compliant



Part Number	Current Range	Output Voltage Tolerance
ASM-010	1 - 10 Amps	±10%
ASM-020	1 - 20 Amps	±10%
ASM-030	1 - 30 Amps	±10%
ASM-050	5 - 50Amps	±10%
ASM-075	5 - 75 Amps	±10%
ASM-100	5 - 100 Amps	±10%

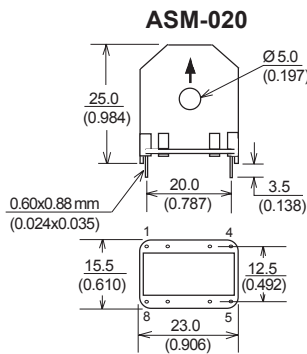
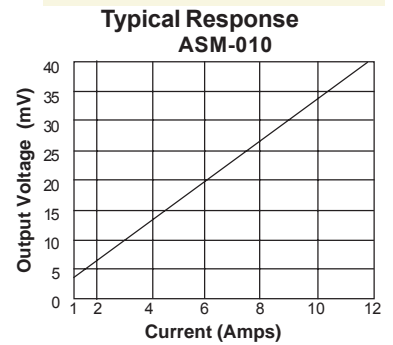
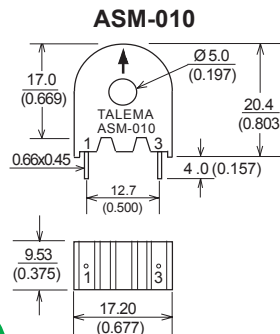

### ASM-010 & ASM-020

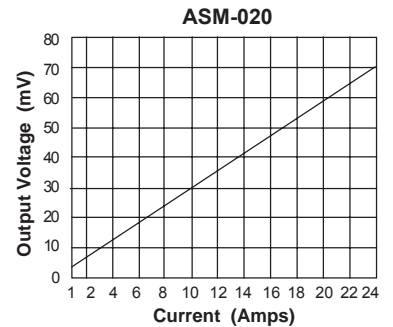
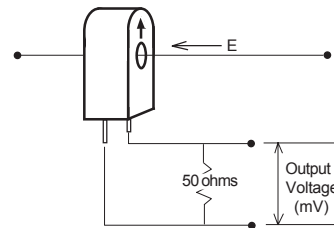

Note: Pins #1 and 8 are Blank

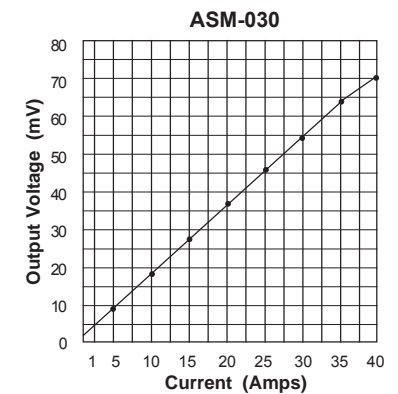
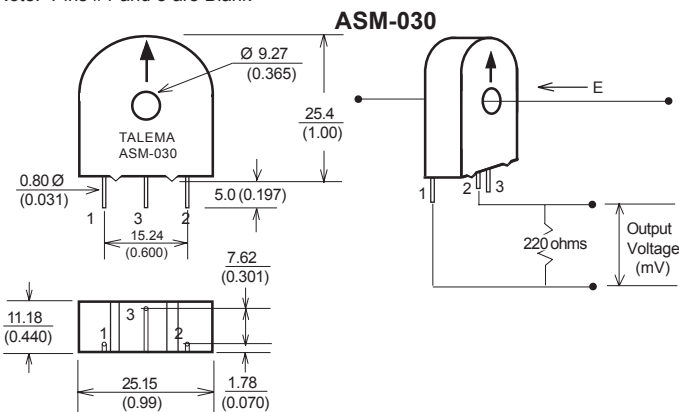

Note: Pin #3 is Blank

### ASM-050, ASM-075 & ASM-100

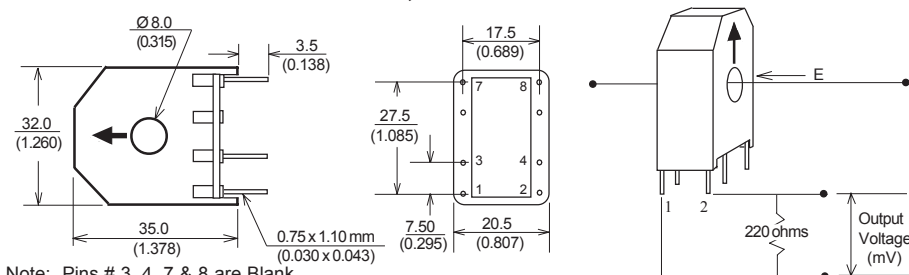

Note: Pins # 3, 4, 7 & 8 are Blank

### ASM-050, ASM-075 & ASM-100

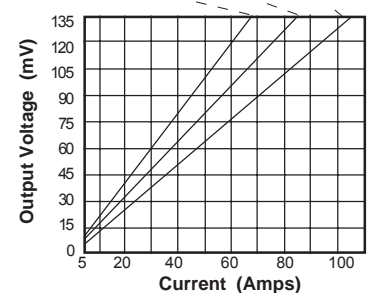

**Regional Locations - Design, Manufacturing, Sales & Marketing**
**Talema Group Regional Offices**
**North America**
**United States  
(Sales & Marketing)**

**Talema Group, LLC**  
 PO Box 935  
 900 Innovation Drive  
 Suite 120, Rolla  
 Missouri 65402  
 Tel: +1 573-303-3675  
 E-Mail:  
[sales@talemagroup.com](mailto:sales@talemagroup.com)  
 Web: [www.talema.com](http://www.talema.com)

**Administrative Office**  
**Talema Electronic India Private Limited**  
 Door No. 221, 1st and 2nd Floor  
 KJ Plaza, Opp.to Vidya Mandir School  
 Meyanoor Main Road  
 Salem - 636 004 Tamil Nadu INDIA  
 Tel: +91 427 - 243 3100  
 Fax: +91 427 - 243 3109  
 E-Mail: [talema@talemaindia.net](mailto:talema@talemaindia.net)  
 Web: [www.talema.com](http://www.talema.com)

**Asia**
**India  
(Design, Manufacturing, Sales & Marketing)**

**Factory Premises**  
**Talema Electronic India Private Limited**  
 Plot Nos. 30, 31 Electrical and Electronic  
 Industrial Estate  
 Suramangalam  
 Salem - 636 005 Tamil Nadu INDIA  
 Tel: +91 427 - 243 3000  
 E-Mail: [talema@talemaindia.net](mailto:talema@talemaindia.net)  
 Web: [www.talema.com](http://www.talema.com)

**Europe**
**Germany  
(Design, Sales & Marketing)**

**Talema Elektronik GmbH**  
 Sembdnerstr. 5  
 82110 Germering  
 Tel: +49 89 - 841 00 - 0  
 Fax: +49 89 - 841 00 25  
 E-Mail: [info@talema.de](mailto:info@talema.de)  
 Web: [www.talema.com](http://www.talema.com)

**Ireland  
(Design, Sales & Marketing)**

**Nuvotem TEO**  
 Units W & X, Gweedore Business Park  
 Derrybeg, Letterkenny, Co. Donegal  
 Tel: +353 (0) 74 95 48666  
 Fax: +353 (0) 74 95 48139  
 E-Mail: [info@nuvotem.com](mailto:info@nuvotem.com)  
 Web: [www.nuvotem.com](http://www.nuvotem.com)

**Czech Republic  
(Design, Manufacturing, Sales & Marketing)**

**NT Magnetics s.r.o.**  
 Chebská 27  
 322 00 Plzeň  
 Tel: +420 377 - 338 351  
 Fax: +420 377 - 338 350  
 E-Mail: [talema@talema.cz](mailto:talema@talema.cz)  
 Web: [www.ntmagnetics.cz](http://www.ntmagnetics.cz)

**Locations of Talema Group Regional Offices**
