

XLamp® XP-E LEDs

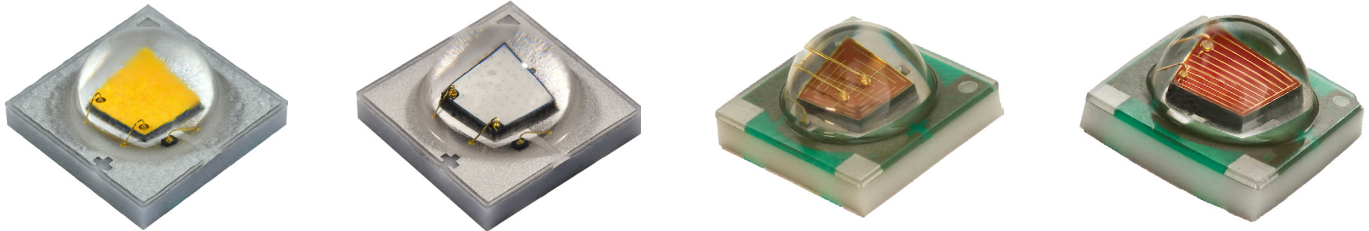

PRODUCT DESCRIPTION

The XLamp® XP-E LED combines the proven lighting-class performance and reliability of the XLamp XR-E LED in a package with 80% smaller footprint. The XLamp XP-E LED continues Cree LED's history of innovation in LEDs for lighting applications with wide viewing angle, symmetrical package, unlimited floor life and electrically neutral thermal path.

XLamp LEDs bring high performance and quality of light to a wide range of lighting applications, including color-changing, portable and personal, outdoor, indoor-directional, transportation, stage and studio, commercial, horticulture and emergency-vehicle lighting.

FEATURES

- Available in white, blue, green, amber, red-orange, red, & High Efficiency (HE) photo red
- Maximum drive current: 1 A
- Low thermal resistance: as low as 5.7 °C/W
- Maximum junction temperature: 150 °C
- Wide viewing angle: 115°-130°
- Unlimited floor life at ≤ 30 °C/85% RH
- Reflow solderable - JEDEC J-STD-020C compatible
- Electrically neutral thermal path
- RoHS and REACH compliant
- UL® recognized component (E349212)



Cree LED / 4001 E. Hwy. 54, Suite 2000 / Durham, NC 27709 USA / +1.919.313.5330 / www.cree-led.com

TABLE OF CONTENTS

Characteristics	3
Order Codes Suggested for New Designs - White	4
Order Codes Suggested for New Designs - Color	9
Relative Spectral Power Distribution	13
Relative Flux vs. Junction Temperature.....	14
Electrical Characteristics.....	15
Relative Flux vs. Current	16
Relative Chromaticity vs. Current and Temperature	18
Typical Spatial Distribution.....	19
Thermal Design	20
Performance Groups - Luminous Flux	21
Performance Groups - Radiant Flux	21
Performance Groups - Chromaticity	22
Performance Groups - Dominant Wavelength	26
Performance Groups - Peak Wavelength.....	26
Performance Groups - Forward Voltage.....	27
Standard Cool White Kits Plotted on ANSI Standard Chromaticity Regions.....	28
Standard Warm and Neutral White Kits Plotted on ANSI Standard Chromaticity Regions	29
Standard Chromaticity Kits	31
Bin and Order Code Formats	32
Reflow Soldering Characteristics.....	33
Notes	34
Mechanical Dimensions	36
Tape and Reel.....	38
Packaging.....	40
Appendix - Order Codes Not For New Designs	41

CHARACTERISTICS

Characteristics	Unit	Minimum	Typical	Maximum
Thermal resistance, junction to solder point - white*	°C/W		5.8	
Thermal resistance, junction to solder point - blue	°C/W		5.7	
Thermal resistance, junction to solder point - green	°C/W		9	
Thermal resistance, junction to solder point - amber	°C/W		7.5	
Thermal resistance, junction to solder point - red-orange, red, HE photo red	°C/W		6.5	
Viewing angle (FWHM) - white	degrees		115	
Viewing angle (FWHM) - blue, green, amber, red-orange, red, HE photo red	degrees		130	
Temperature coefficient of voltage - white	mV/°C		-1.5	
Temperature coefficient of voltage - blue	mV/°C		-1.9	
Temperature coefficient of voltage - green	mV/°C		-1.2	
Temperature coefficient of voltage - amber	mV/°C		-2.1	
Temperature coefficient of voltage - red-orange, red	mV/°C		-1.8	
Temperature coefficient of voltage - HE photo red	mV/°C		-1.6	
ESD classification (HBM per Mil-Std-883D)			Class 2	
DC forward current	mA			1000
Reverse voltage	V			1
Forward voltage (@ 350 mA) - white	V		2.93	3.4
Forward voltage (@ 350 mA) - blue	V		2.95	3.4
Forward voltage (@ 350 mA) - green	V		2.85	3.25
Forward voltage (@ 350 mA) - amber, red-orange, red, HE photo red	V		2.1	2.5
Forward voltage (@ 500 mA) - amber	V		2.3	
Forward voltage (@ 700 mA) - white	V		3.1	
Forward voltage (@ 700 mA) - red-orange, red, HE photo red	V		2.3	
Forward voltage (@ 1000 mA) - white	V		3.23	
Forward voltage (@ 1000 mA) - blue	V		3.27	
Forward voltage (@ 1000 mA) - green	V		3.16	
Forward voltage (@ 1000 mA) - HE photo red	V		2.5	
LED junction temperature	°C			150

Note

- ◆ Thermal resistance measurement was performed per the JEDEC JESD51-14 standard. See the [Thermal Resistance Measurement application note](#) for more details.

ORDER CODES SUGGESTED FOR NEW DESIGNS - WHITE ($T_j = 25\text{ }^\circ\text{C}$)

The following table provides order codes for XLamp XP-E white LEDs. For a complete description of the order code nomenclature, please see the Bin and Order Code Formats section (page 32).

Minimum Luminous Flux (lm) @ 350 mA		Chromaticity Regions	Order Codes
Group	Flux (lm)		
S2	148	WA, WB, WC, WD, WE, WF, WG, WH, WJ, WK, WM, WN, WP	XPEWHT-L1-0000-00J01
		WC, WD, WF, WG	XPEWHT-L1-0000-00J02
		WC, WD, WF, WG, WH, WJ, WN, WP	XPEWHT-L1-0000-00J03
S3	156	WA, WB, WC, WD, WE, WF, WG, WH, WJ, WK, WM, WN, WP	XPEWHT-L1-0000-00K01
		WC, WD, WF, WG	XPEWHT-L1-0000-00K02
		WC, WD, WF, WG, WH, WJ, WN, WP	XPEWHT-L1-0000-00K03
S4	164	WA, WB, WC, WD, WE, WF, WG, WH, WJ, WK, WM, WN, WP	XPEWHT-L1-0000-00L01
		WC, WD, WF, WG	XPEWHT-L1-0000-00L02
		WC, WD, WF, WG, WH, WJ, WN, WP	XPEWHT-L1-0000-00L03

Notes:

- Cree LED maintains a tolerance of $\pm 7\%$ on flux and power measurements, ± 0.005 on chromaticity (CCx, CCy) measurements and a tolerance of ± 2 on CRI measurements. See the Measurements section (page 34).
- XLamp XP-E LED order codes specify only a minimum flux bin and not a maximum. Cree LED may ship reels in flux bins higher than the minimum specified by the order code without advance notice. Shipments will always adhere to the chromaticity bin restrictions specified by the order code.

ORDER CODES SUGGESTED FOR NEW DESIGNS - WHITE ($T_j = 25\text{ }^\circ\text{C}$) - CONTINUED

The following tables provide order codes for XLamp XP-E white LEDs. For a complete description of the order code nomenclature, please see the Bin and Order Code Formats section (page 32). For definitions of the chromaticity kits, please see the Standard Chromaticity Kits section (page 31).

Chromaticity		Minimum Luminous Flux (lm) @ 350 mA		Order Codes
Kit	CCT	Code	Flux (lm)	70 CRI Typical
51	6200 K	S4	164	XPEWHT-L1-0000-00L51
		S3	156	XPEWHT-L1-0000-00K51
		S2	148	XPEWHT-L1-0000-00J51
53	6000 K	S4	164	XPEWHT-L1-0000-00L53
		S3	156	XPEWHT-L1-0000-00K53
		S2	148	XPEWHT-L1-0000-00J53
50	6200 K	S4	164	XPEWHT-L1-0000-00L50
		S3	156	XPEWHT-L1-0000-00K50
		S2	148	XPEWHT-L1-0000-00J50
E1	6500 K	S4	164	XPEWHT-L1-0000-00LE1
		S3	156	XPEWHT-L1-0000-00KE1
		S2	148	XPEWHT-L1-0000-00JE1
E2	5700 K	S4	164	XPEWHT-L1-0000-00LE2
		S3	156	XPEWHT-L1-0000-00KE2
		S2	148	XPEWHT-L1-0000-00JE2

Notes:

- Cree LED maintains a tolerance of $\pm 7\%$ on flux and power measurements, ± 0.005 on chromaticity (CCx, CCy) measurements and a tolerance of ± 2 on CRI measurements. See the Measurements section (page 34).
- XLamp XP-E LED order codes specify only a minimum flux bin and not a maximum. Cree LED may ship reels in flux bins higher than the minimum specified by the order code without advance notice. Shipments will always adhere to the chromaticity bin restrictions specified by the order code.

ORDER CODES SUGGESTED FOR NEW DESIGNS - WHITE ($T_j = 25\text{ }^\circ\text{C}$) - CONTINUED

Chromaticity		Minimum Luminous Flux (lm) @ 350 mA		Order Codes	
Kit	CCT	Code	Flux (lm)	75 CRI Typical	80 CRI Minimum
E3	5000 K	S5	172	XPEWHT-L1-0000-00ME3	
		S4	164	XPEWHT-L1-0000-00LE3	
		S3	156	XPEWHT-L1-0000-00KE3	
F4	4750 K	S4	164	XPEWHT-L1-0000-00LF4	
		S3	156	XPEWHT-L1-0000-00KF4	
		S2	148	XPEWHT-L1-0000-00JF4	
E4	4500 K	S4	164	XPEWHT-L1-0000-00LE4	
		S3	156	XPEWHT-L1-0000-00KE4	
		S2	148	XPEWHT-L1-0000-00JE4	
F5	4250 K	S4	164	XPEWHT-L1-0000-00LF5	
		S3	156	XPEWHT-L1-0000-00KF5	
		S2	148	XPEWHT-L1-0000-00JF5	
E5	4000 K	S4	164	XPEWHT-L1-0000-00LE5	
		S3	156	XPEWHT-L1-0000-00KE5	XPEWHT-H1-0000-00KE5
		S2	148	XPEWHT-L1-0000-00JE5	XPEWHT-H1-0000-00JE5
Z5	4000 K	S3	156	XPEWHT-L1-0000-00KZ5	XPEWHT-H1-0000-00KZ5
		S2	148	XPEWHT-L1-0000-00JZ5	XPEWHT-H1-0000-00JZ5

Notes:

- Cree LED maintains a tolerance of $\pm 7\%$ on flux and power measurements, ± 0.005 on chromaticity (CCx, CCy) measurements and a tolerance of ± 2 on CRI measurements. See the Measurements section (page 34).
- XLamp XP-E LED order codes specify only a minimum flux bin and not a maximum. Cree LED may ship reels in flux bins higher than the minimum specified by the order code without advance notice. Shipments will always adhere to the chromaticity bin restrictions specified by the order code.

ORDER CODES SUGGESTED FOR NEW DESIGNS - WHITE (T_J = 25 °C) - CONTINUED

Chromaticity		Minimum Luminous Flux (lm) @ 350 mA		Order Codes		
Kit	CCT	Code	Flux (lm)	80 CRI Typical	80 CRI Minimum	90 CRI Minimum
F6	3750 K	S2	148	XPEWHT-L1-0000-00JF6	XPEWHT-H1-0000-00JF6	
		R5	139	XPEWHT-L1-0000-00HF6	XPEWHT-H1-0000-00HF6	
E6	3500 K	R5	139	XPEWHT-L1-0000-00HE6	XPEWHT-H1-0000-00HE6	
		R4	130	XPEWHT-L1-0000-00GE6	XPEWHT-H1-0000-00GE6	
Z6	3500 K	R5	139	XPEWHT-L1-0000-00HZ6	XPEWHT-H1-0000-00ZE6	
		R4	130	XPEWHT-L1-0000-00GZ6	XPEWHT-H1-0000-00ZE6	
F7	3250 K	R5	139	XPEWHT-L1-0000-00HF7	XPEWHT-H1-0000-00HF7	
		R4	130	XPEWHT-L1-0000-00GF7	XPEWHT-H1-0000-00GF7	
E7	3000 K	R5	139	XPEWHT-L1-0000-00HE7	XPEWHT-H1-0000-00HE7	
		R4	130	XPEWHT-L1-0000-00GE7	XPEWHT-H1-0000-00GE7	
		R3	122			
		R2	114			
		Q5	107			XPEWHT-U1-0000-00DE7
		Q4	100			XPEWHT-U1-0000-00CE7
Z7	3000 K	R5	139	XPEWHT-L1-0000-00HE7	XPEWHT-H1-0000-00HE7	
		R4	130	XPEWHT-L1-0000-00GE7	XPEWHT-H1-0000-00GE7	
		R3	122			
		R2	114			
		Q5	107			XPEWHT-U1-0000-00DZ7
		Q4	100			XPEWHT-U1-0000-00CZ7
F8	2850 K	R5	139	XPEWHT-L1-0000-00HF8	XPEWHT-H1-0000-00HF8	
		R4	130	XPEWHT-L1-0000-00GF8	XPEWHT-H1-0000-00GF8	
		R3	122	XPEWHT-L1-0000-00FF8	XPEWHT-H1-0000-00FF8	
		R2	114			
		Q5	107			XPEWHT-U1-0000-00DF8
		Q4	100			XPEWHT-U1-0000-00CF8
		Q3	93.9			XPEWHT-U1-0000-00BF8
E8	2700 K	R5	139	XPEWHT-L1-0000-00HE8	XPEWHT-H1-0000-00HE8	
		R4	130	XPEWHT-L1-0000-00GE8	XPEWHT-H1-0000-00GE8	
		R3	122	XPEWHT-L1-0000-00FE8	XPEWHT-H1-0000-00FE8	
		R2	114			
		Q5	107			XPEWHT-U1-0000-00DF8
		Q4	100			XPEWHT-U1-0000-00CF8
		Q3	93.9			XPEWHT-U1-0000-00BF8

Notes:

- Cree LED maintains a tolerance of ±7% on flux and power measurements, ±0.005 on chromaticity (CCx, CCy) measurements and a tolerance of ±2 on CRI measurements. See the Measurements section (page 34).
- XLamp XP-E LED order codes specify only a minimum flux bin and not a maximum. Cree LED may ship reels in flux bins higher than the minimum specified by the order code without advance notice. Shipments will always adhere to the chromaticity bin restrictions specified by the order code.

ORDER CODES SUGGESTED FOR NEW DESIGNS - WHITE ($T_j = 25\text{ }^\circ\text{C}$) - CONTINUED

Chromaticity		Minimum Luminous Flux (lm) @ 350 mA		Order Codes		
Kit	CCT	Code	Flux (lm)	80 CRI Typical	80 CRI Minimum	90 CRI Minimum
Z8	2700 K	R5	139	XPEWHT-L1-0000-00HZ8	XPEWHT-H1-0000-00HZ8	
		R4	130	XPEWHT-L1-0000-00GZ8	XPEWHT-H1-0000-00GZ8	
		R3	122	XPEWHT-L1-0000-00FZ8	XPEWHT-H1-0000-00FZ8	
		R2	114			
		Q5	107			
		Q4	100			XPEWHT-U1-0000-00CZ8
		Q3	93.9			XPEWHT-U1-0000-00BZ8

Notes:

- Cree LED maintains a tolerance of $\pm 7\%$ on flux and power measurements, ± 0.005 on chromaticity (CCx, CCy) measurements and a tolerance of ± 2 on CRI measurements. See the Measurements section (page 34).
- XLamp XP-E LED order codes specify only a minimum flux bin and not a maximum. Cree LED may ship reels in flux bins higher than the minimum specified by the order code without advance notice. Shipments will always adhere to the chromaticity bin restrictions specified by the order code.

ORDER CODES SUGGESTED FOR NEW DESIGNS - COLOR ($T_j = 25\text{ }^\circ\text{C}$)

The following tables provide order codes for XLamp XP-E color LEDs. For a complete description of the order code nomenclature, please see the Bin and Order Code Formats section (page 32).

Color	Minimum Luminous Flux (lm)@ 350 mA		Dominant Wavelength (nm)				Order Codes
			Minimum		Maximum		
	Group	Flux (lm)	Group	DWL (nm)	Group	DWL (nm)	
Blue	K2	30.6	B3	465	B6	485	XPEBLU-L1-0000-00Y01
			B3	465	B5	480	XPEBLU-L1-0000-00Y02
	K3	35.2	B3	465	B6	485	XPEBLU-L1-0000-00Z01
			B3	465	B5	480	XPEBLU-L1-0000-00Z02
	M2	39.8	B3	465	B6	485	XPEBLU-L1-0000-00201
			B3	465	B5	480	XPEBLU-L1-0000-00202
			B4	470	B5	480	XPEBLU-L1-0000-00205
	M3	45.7	B3	465	B6	485	XPEBLU-L1-0000-00301
			B3	465	B5	480	XPEBLU-L1-0000-00302
			B4	470	B5	480	XPEBLU-L1-0000-00305
	N2	51.7	B3	465	B6	485	XPEBLU-L1-0000-00401
			B3	465	B5	480	XPEBLU-L1-0000-00402
			B4	470	B5	480	XPEBLU-L1-0000-00405
	N3	56.8	B3	465	B6	485	XPEBLU-L1-0000-00501
			B3	465	B5	480	XPEBLU-L1-0000-00502
			B4	470	B5	480	XPEBLU-L1-0000-00505
	N4	62.0	B3	465	B6	485	XPEBLU-L1-0000-00601

Notes:

- Cree LED maintains a tolerance of $\pm 7\%$ on flux and power measurements, and $\pm 1\text{ nm}$ on dominant wavelength measurements. See the Measurements section (page 34).
- XLamp XP-E LED order codes specify only a minimum flux bin and not a maximum. Cree LED may ship reels in flux bins higher than the minimum specified by the order code without advance notice. Shipments will always adhere to the chromaticity bin restrictions specified by the order code.
- Calculated Photosynthetic Photon Flux (PPF) values are for reference only.

ORDER CODES SUGGESTED FOR NEW DESIGNS - COLOR (T_J = 25 °C) - CONTINUED

Color	Minimum Luminous Flux (lm)@ 350 mA		Calculated Minimum PPF (μmol/s)	Dominant Wavelength (nm)				Order Codes
				Minimum		Maximum		
	Group	Flux (lm)		Group	DWL (nm)	Group	DWL (nm)	
Green	P4	80.6	0.74	G2	520	G4	535	XPEGRN-L1-0000-00901
				G2	520	G3	530	XPEGRN-L1-0000-00902
				G3	525	G4	535	XPEGRN-L1-0000-00903
	Q2	87.4	0.80	G2	520	G4	535	XPEGRN-L1-0000-00A01
				G2	520	G3	530	XPEGRN-L1-0000-00A02
				G3	525	G4	535	XPEGRN-L1-0000-00A03
	Q3	93.9	0.86	G2	520	G4	535	XPEGRN-L1-0000-00B01
				G2	520	G3	530	XPEGRN-L1-0000-00B02
				G3	525	G4	535	XPEGRN-L1-0000-00B03
	Q4	100	0.91	G2	520	G4	535	XPEGRN-L1-0000-00C01
				G2	520	G3	530	XPEGRN-L1-0000-00C02
				G3	525	G4	535	XPEGRN-L1-0000-00C03
	Q5	107	0.98	G2	520	G4	535	XPEGRN-L1-0000-00D01
				G2	520	G3	530	XPEGRN-L1-0000-00D02
				G3	525	G4	535	XPEGRN-L1-0000-00D03
	R2	114	1.04	G2	520	G4	535	XPEGRN-L1-0000-00E01
				G2	520	G3	530	XPEGRN-L1-0000-00E02
				G3	525	G4	535	XPEGRN-L1-0000-00E03
	R3	122	1.11	G2	520	G4	535	XPEGRN-L1-0000-00F01
				G2	520	G3	530	XPEGRN-L1-0000-00F02

Color	Minimum Luminous Flux (lm)@ 350 mA		Dominant Wavelength (nm)				Order Codes
			Minimum		Maximum		
	Group	Flux (lm)	Group	DWL (nm)	Group	DWL (nm)	
Amber	M3	45.7	A2	585	A3	595	XPEAMB-L1-0000-00301
			A3	590	A3	595	XPEAMB-L1-0000-00303
	N2	51.7	A2	585	A3	595	XPEAMB-L1-0000-00401
			A3	590	A3	595	XPEAMB-L1-0000-00403
	N3	56.8	A2	585	A3	595	XPEAMB-L1-0000-00501
			A3	590	A3	595	XPEAMB-L1-0000-00503
	N4	62.0	A2	585	A3	595	XPEAMB-L1-0000-00601
			A3	590	A3	595	XPEAMB-L1-0000-00603
	P2	67.2	A2	585	A3	595	XPEAMB-L1-0000-00701
			A3	590	A3	595	XPEAMB-L1-0000-00703

Notes:

- Cree LED maintains a tolerance of ±7% on flux and power measurements, ±0.005 on chromaticity (CCx, CCy) measurements and a tolerance of ±2 on CRI measurements. See the Measurements section (page 34).
- XLamp XP-E LED order codes specify only a minimum flux bin and not a maximum. Cree LED may ship reels in flux bins higher than the minimum specified by the order code without advance notice. Shipments will always adhere to the chromaticity bin restrictions specified by the order code.

ORDER CODES SUGGESTED FOR NEW DESIGNS - COLOR (T_j = 25 °C) - CONTINUED

Color	Minimum Luminous Flux (lm)@ 350 mA		Dominant Wavelength (nm)				Order Codes
			Minimum		Maximum		
	Group	Flux (lm)	Group	DWL (nm)	Group	DWL (nm)	
Red-Orange	N3	56.8	03	610	04	620	XPERDO-L1-0000-00501
			03	610	03	615	XPERDO-L1-0000-00502
			04	615	04	620	XPERDO-L1-0000-00503
	N4	62.0	03	610	04	620	XPERDO-L1-0000-00601
			03	610	03	615	XPERDO-L1-0000-00602
			04	615	04	620	XPERDO-L1-0000-00603
	P2	67.2	03	610	04	620	XPERDO-L1-0000-00701
			03	610	03	615	XPERDO-L1-0000-00702
			04	615	04	620	XPERDO-L1-0000-00703
	P3	73.9	03	610	04	620	XPERDO-L1-0000-00801
			03	610	03	615	XPERDO-L1-0000-00802
			04	615	04	620	XPERDO-L1-0000-00803
	P4	80.6	03	610	04	620	XPERDO-L1-0000-00901
			03	610	03	615	XPERDO-L1-0000-00902
			04	615	04	620	XPERDO-L1-0000-00903
	Q2	87.4	03	610	04	620	XPERDO-L1-0000-00A01
			03	610	03	615	XPERDO-L1-0000-00A02
			04	615	04	620	XPERDO-L1-0000-00A03

Color	Minimum Luminous Flux (lm)@ 350 mA		Calculated Minimum PPF (μmol/s)	Dominant Wavelength (nm)				Order Codes
				Minimum		Maximum		
	Group	Flux (lm)		Group	DWL (nm)	Group	DWL (nm)	
Red	M3	45.7	1.19	R2	620	R3	630	XPERED-L1-0000-00301
				R2	620	R2	625	XPERED-L1-0000-00302
	N2	51.7	1.35	R2	620	R3	630	XPERED-L1-0000-00401
				R2	620	R2	625	XPERED-L1-0000-00402
	N3	56.8	1.48	R2	620	R3	630	XPERED-L1-0000-00501
				R2	620	R2	625	XPERED-L1-0000-00502
	N4	62	1.61	R2	620	R3	630	XPERED-L1-0000-00601
				R2	620	R2	625	XPERED-L1-0000-00602
	P2	67.2	1.75	R2	620	R3	630	XPERED-L1-0000-00701
				R2	620	R2	625	XPERED-L1-0000-00702
	P3	73.9	1.92	R2	620	R3	630	XPERED-L1-0000-00801
				R2	620	R2	625	XPERED-L1-0000-00802

Notes:

- Cree LED maintains a tolerance of ±7% on flux and power measurements, and ±1 nm on dominant wavelength measurements. See the Measurements section (page 34).
- XLamp XP-E LED order codes specify only a minimum flux bin and not a maximum. Cree LED may ship reels in flux bins higher than the minimum specified by the order code without advance notice. Shipments will always adhere to the chromaticity bin restrictions specified by the order code.
- Calculated Photosynthetic Photon Flux (PPF) values are for reference only.

ORDER CODES SUGGESTED FOR NEW DESIGNS - COLOR ($T_j = 25\text{ }^\circ\text{C}$) - CONTINUED

Color	Minimum Radiant Flux (mW)@ 350 mA		Calculated Minimum PPF ($\mu\text{mol/s}$)	Peak Wavelength (nm)				Order Codes
				Minimum		Maximum		
	Group	Flux (mW)		Group	PWL (nm)	Group	PWL (nm)	
HE Photo Red	26	350	1.93	P2	650	P5	670	XPEEPR-L1-0000-00901
	27	375	2.06	P2	650	P5	670	XPEEPR-L1-0000-00A01
	28	400	2.20	P2	650	P5	670	XPEEPR-L1-0000-00B01
	29	425	2.34	P2	650	P5	670	XPEEPR-L1-0000-00C01

Notes:

- Cree LED maintains a tolerance of $\pm 7\%$ on flux and power measurements, and $\pm 1\text{ nm}$ on dominant wavelength measurements. See the Measurements section (page 34).
- XLamp XP-E LED order codes specify only a minimum flux bin and not a maximum. Cree LED may ship reels in flux bins higher than the minimum specified by the order code without advance notice. Shipments will always adhere to the chromaticity bin restrictions specified by the order code.
- Calculated Photosynthetic Photon Flux (PPF) values are for reference only.

RELATIVE SPECTRAL POWER DISTRIBUTION

White

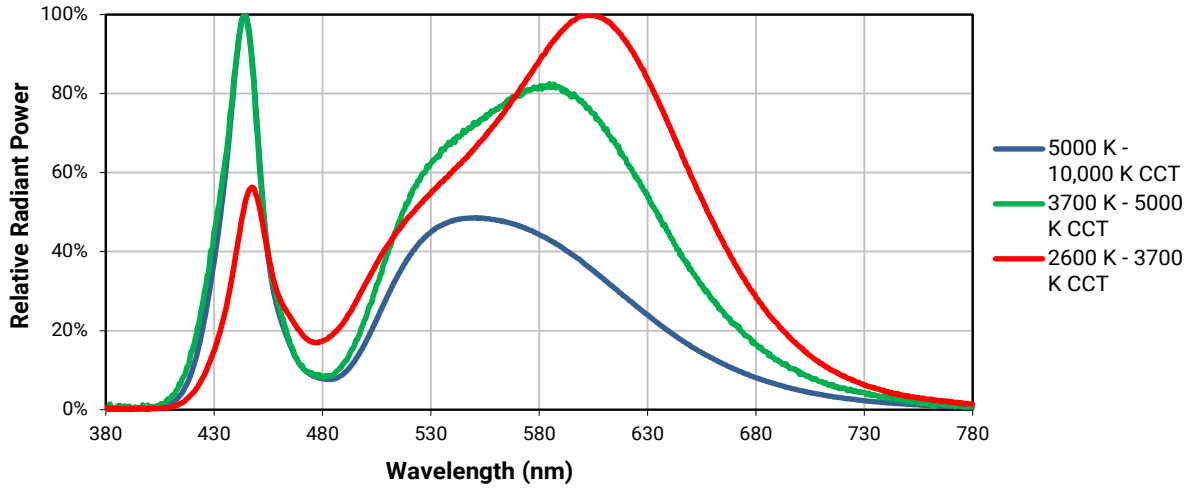

Color

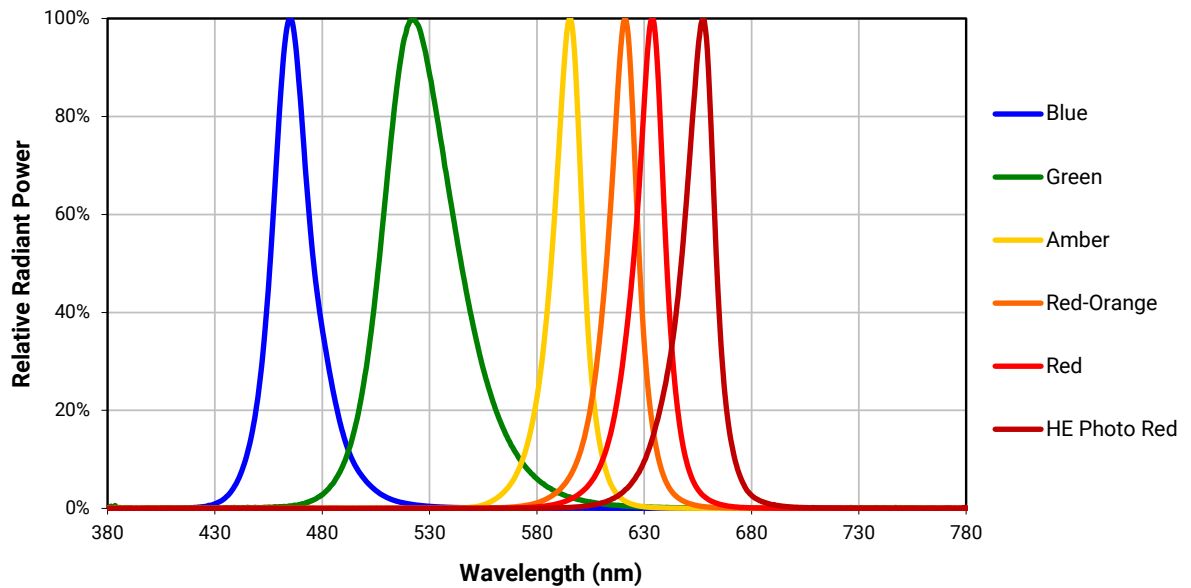

RELATIVE FLUX VS. JUNCTION TEMPERATURE ($I_f = 350 \text{ mA}$)

White

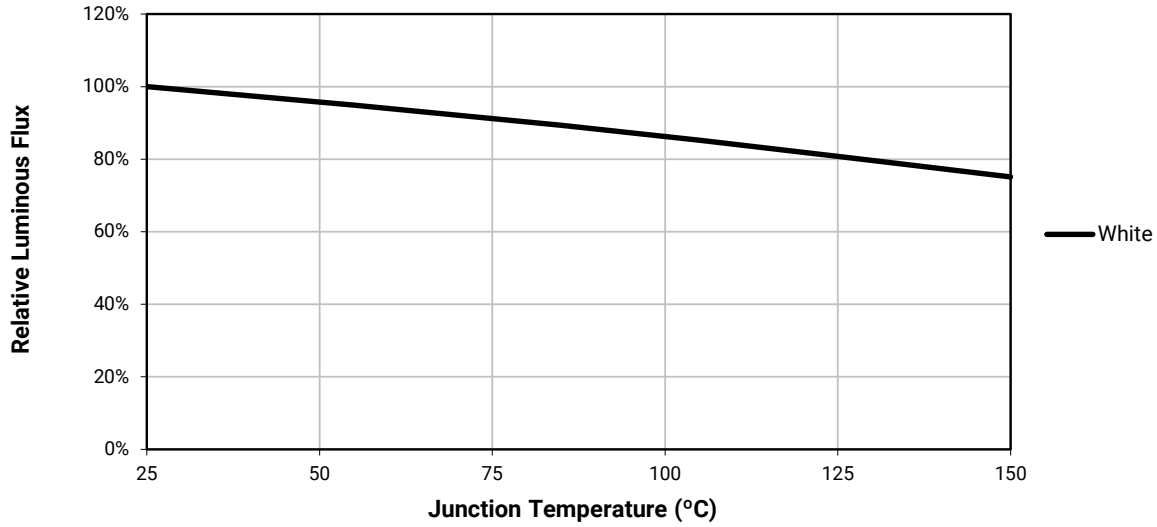

Color

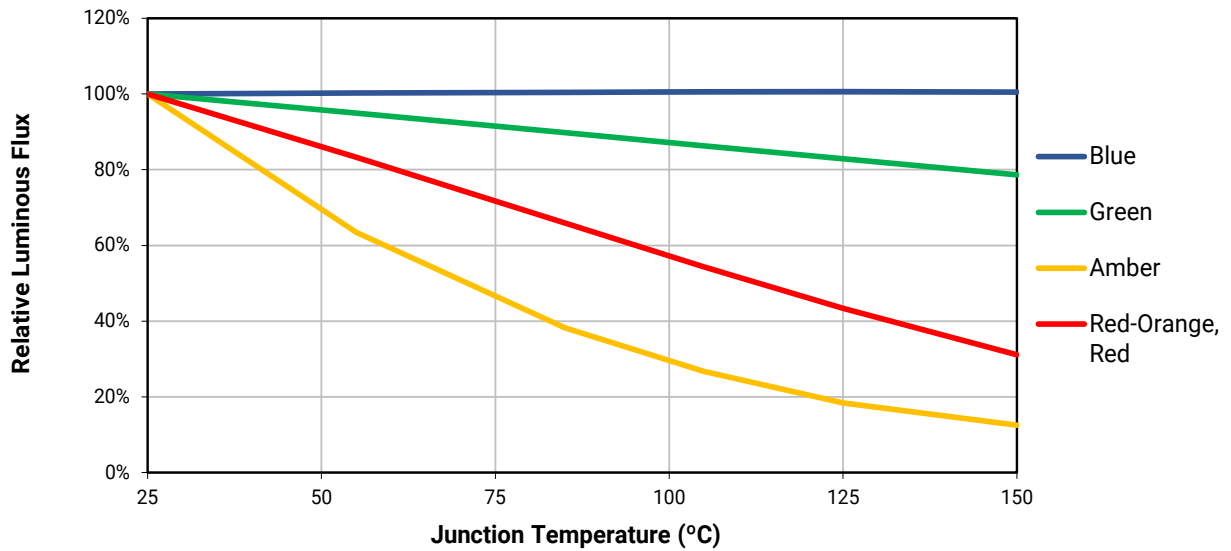

RELATIVE FLUX VS. JUNCTION TEMPERATURE ($I_f = 350 \text{ mA}$) - CONTINUED

Color

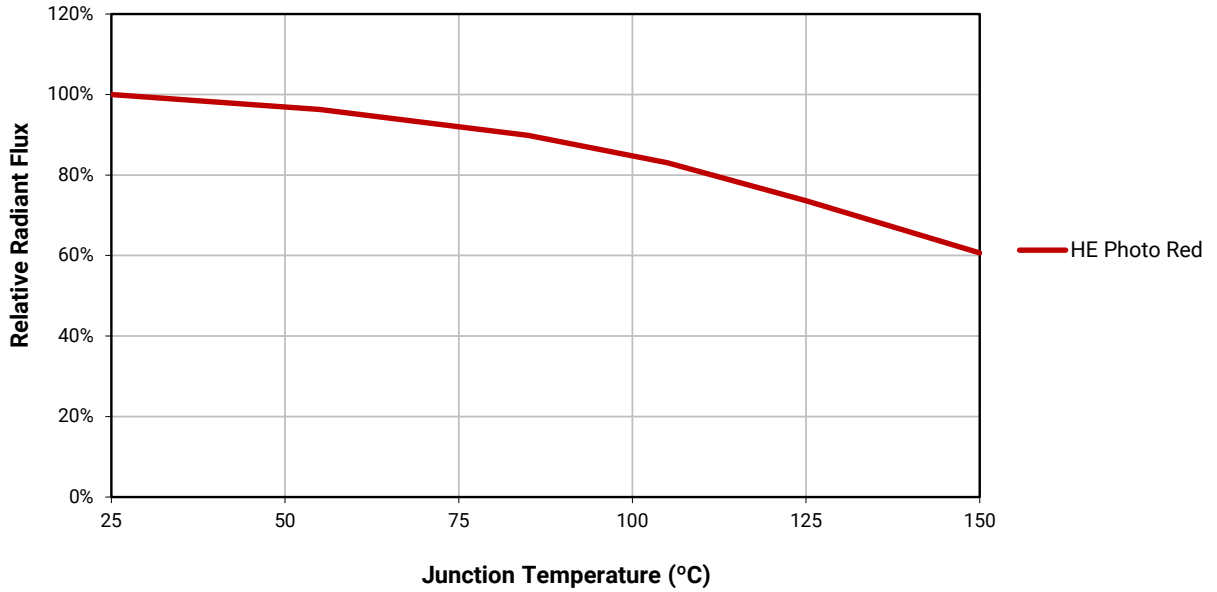

ELECTRICAL CHARACTERISTICS ($T_j = 25 \text{ °C}$)

White

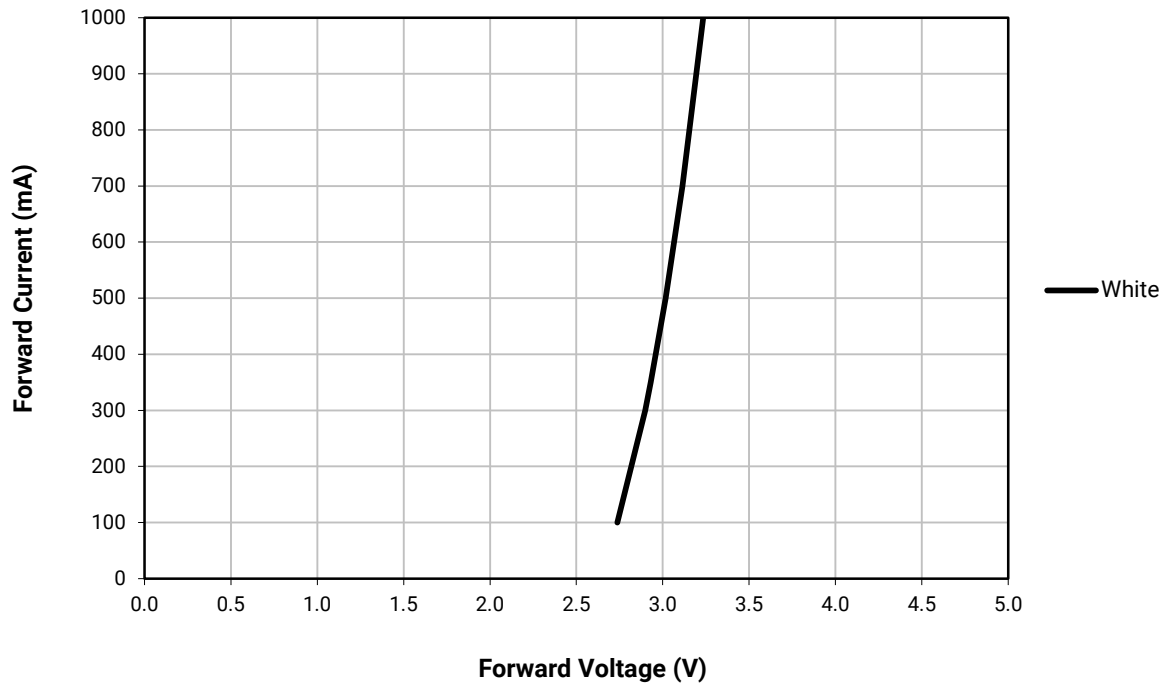

ELECTRICAL CHARACTERISTICS (T_j = 25 °C) - CONTINUED

Color

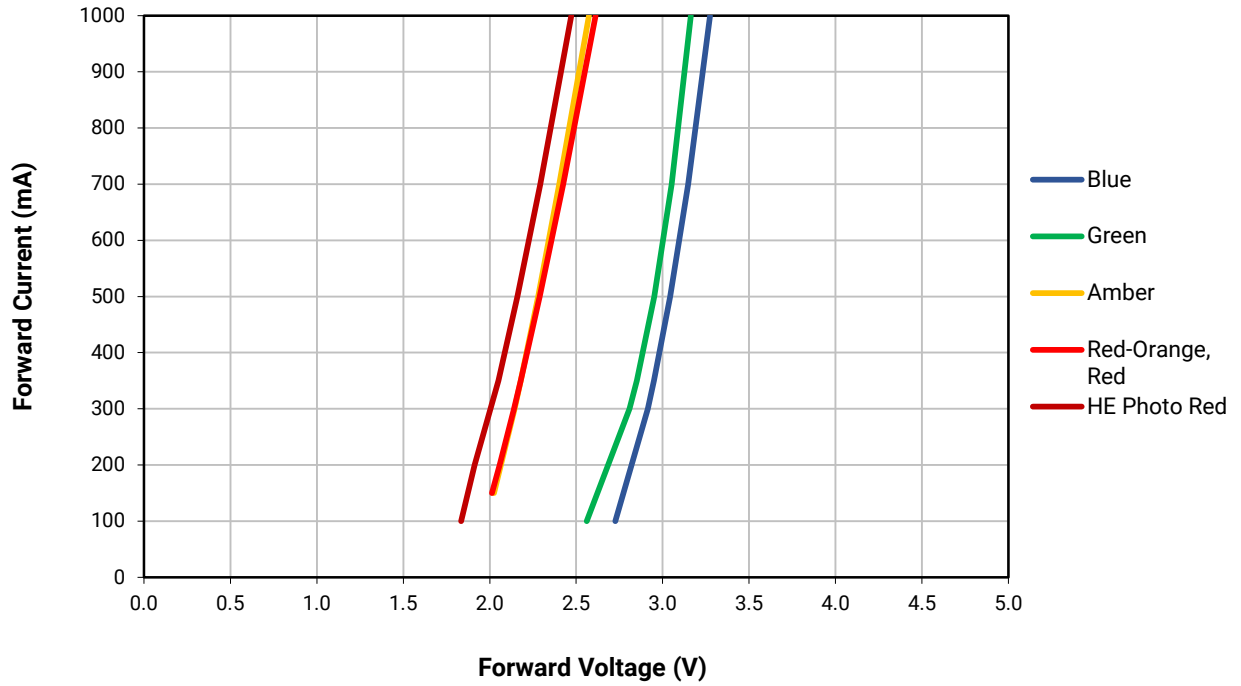

RELATIVE FLUX VS. CURRENT (T_j = 25 °C)

White

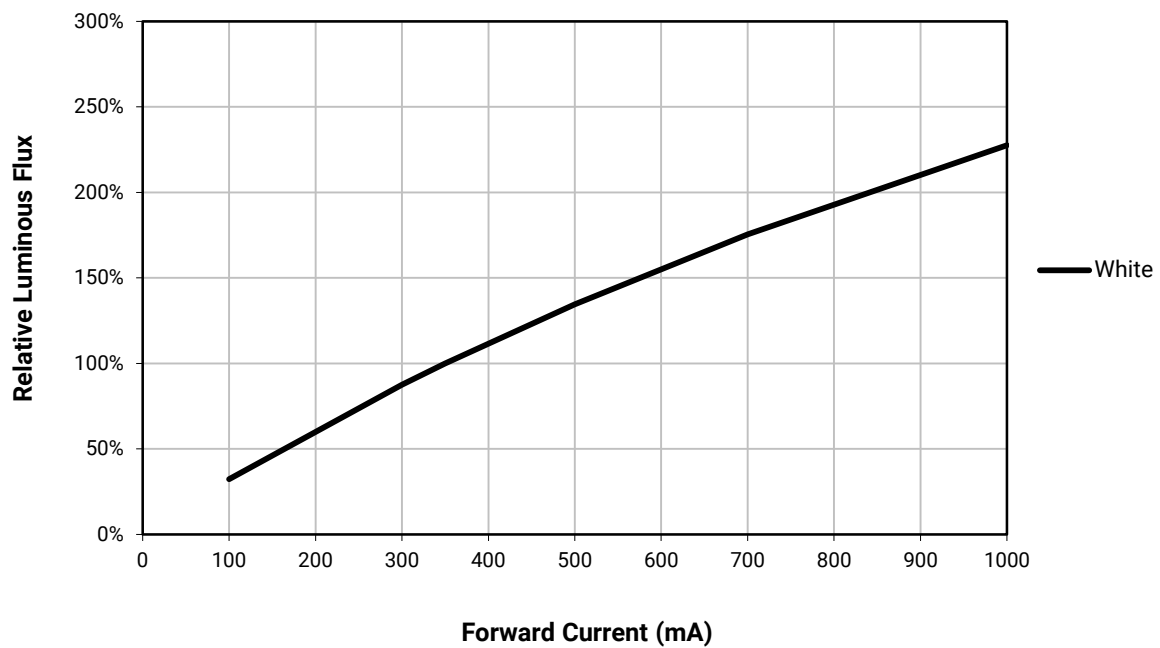

RELATIVE FLUX VS. CURRENT ($T_j = 25\text{ }^\circ\text{C}$) - CONTINUED

Color

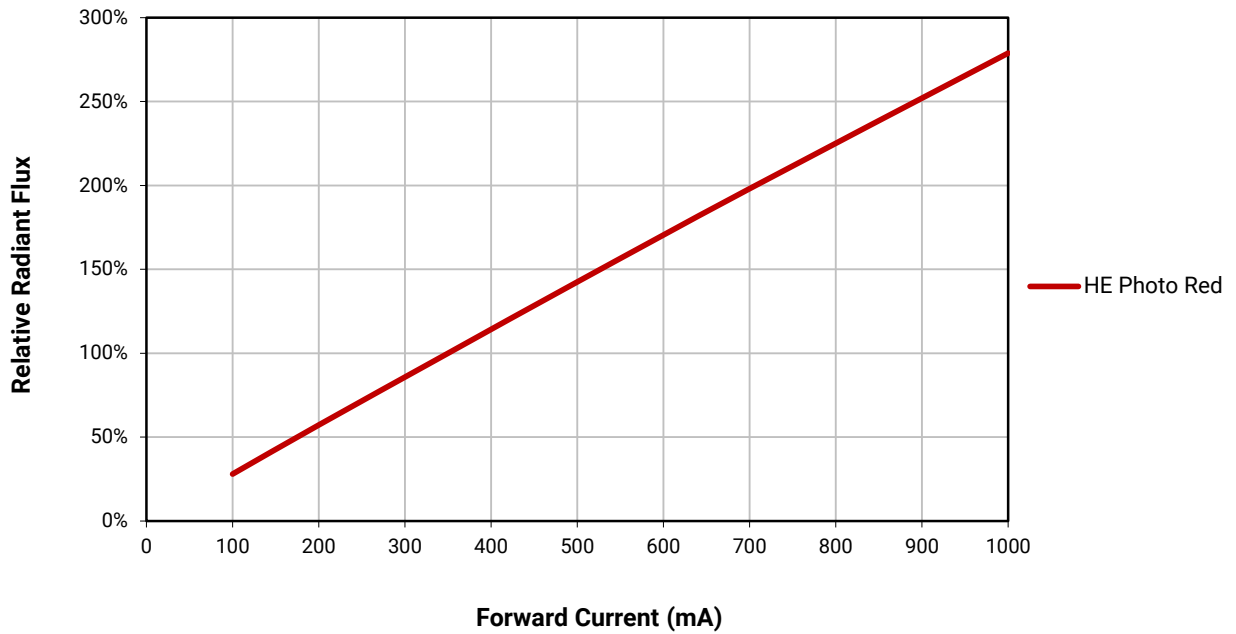
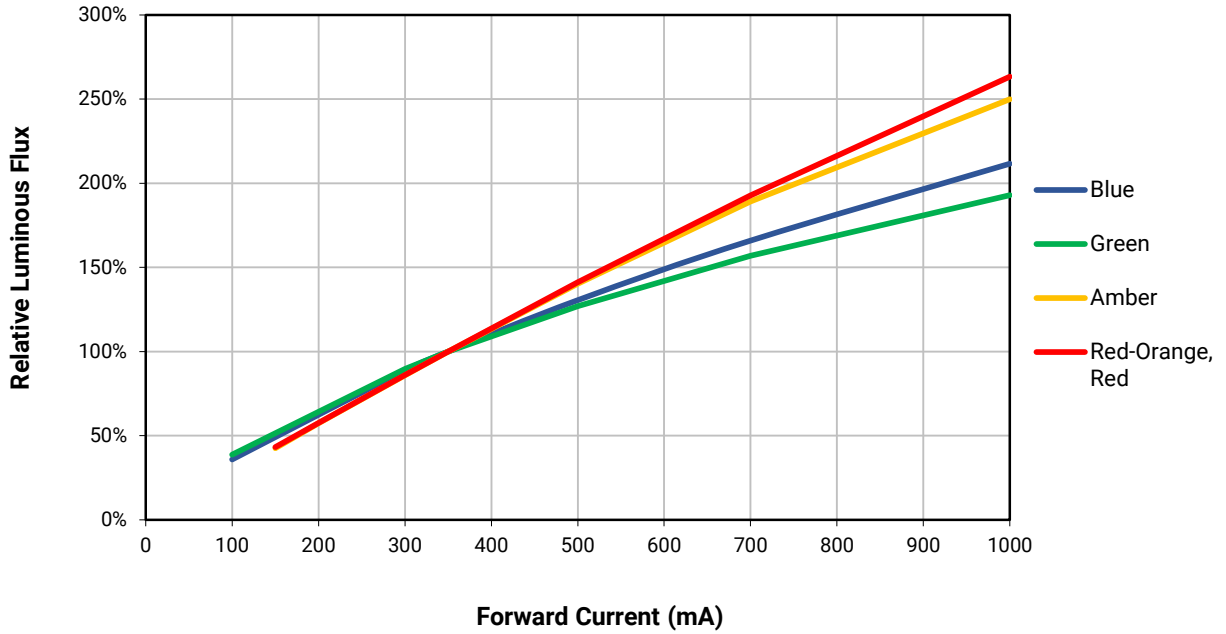

RELATIVE CHROMATICITY VS. CURRENT AND TEMPERATURE - WARM WHITE

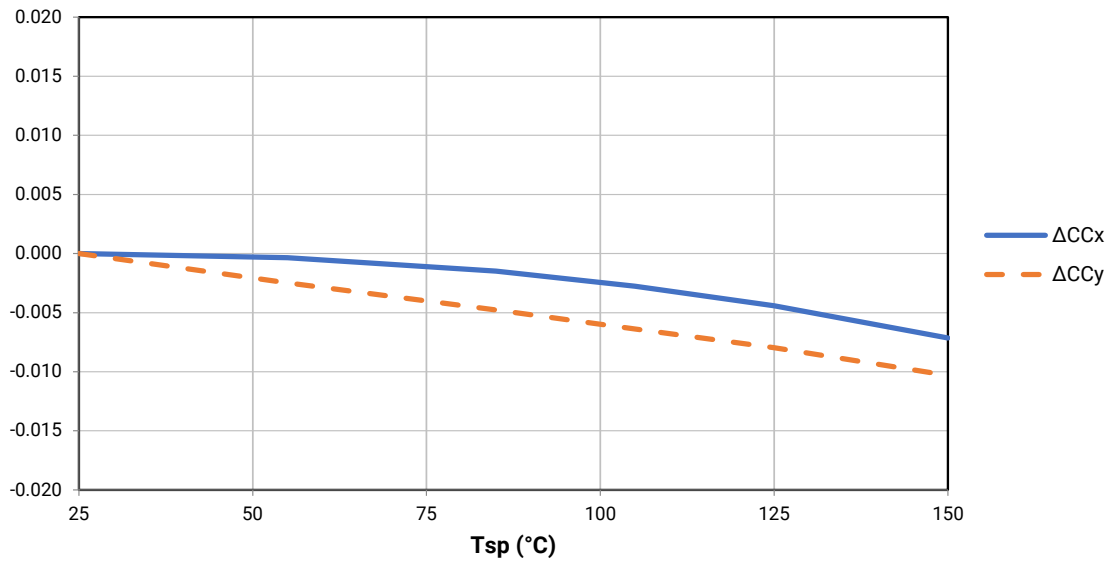
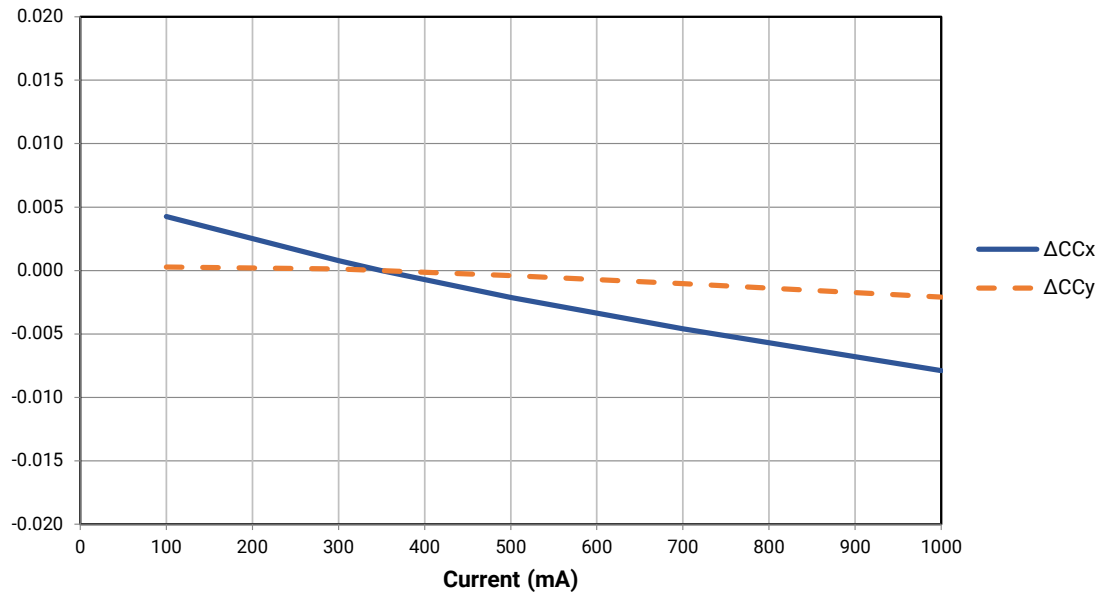

TYPICAL SPATIAL DISTRIBUTION

White

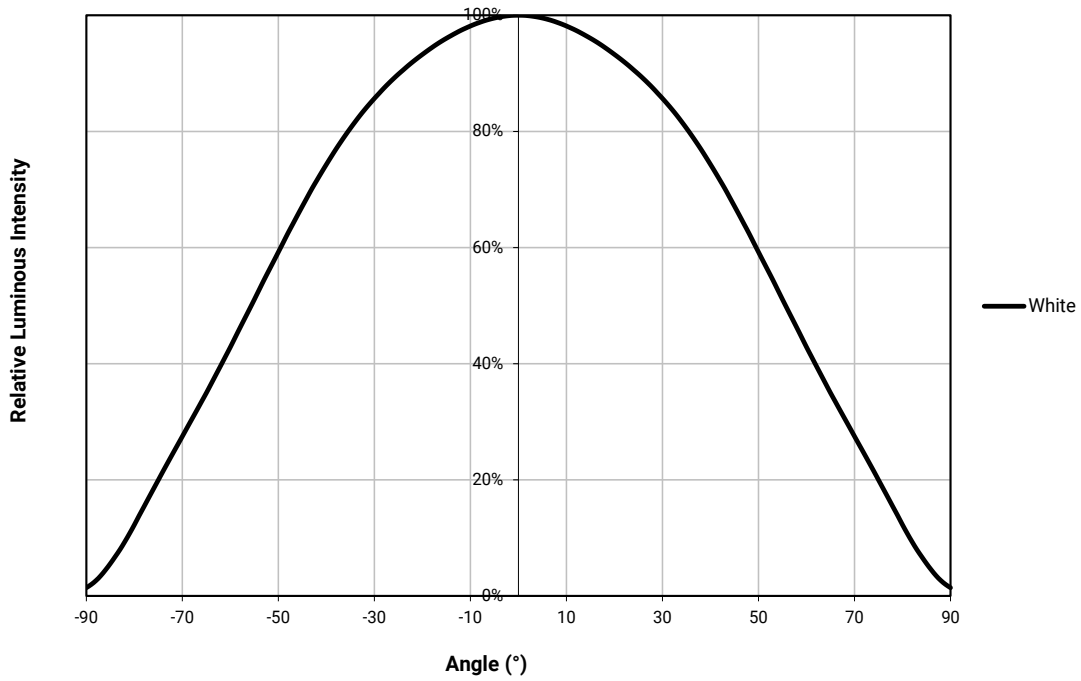

Color

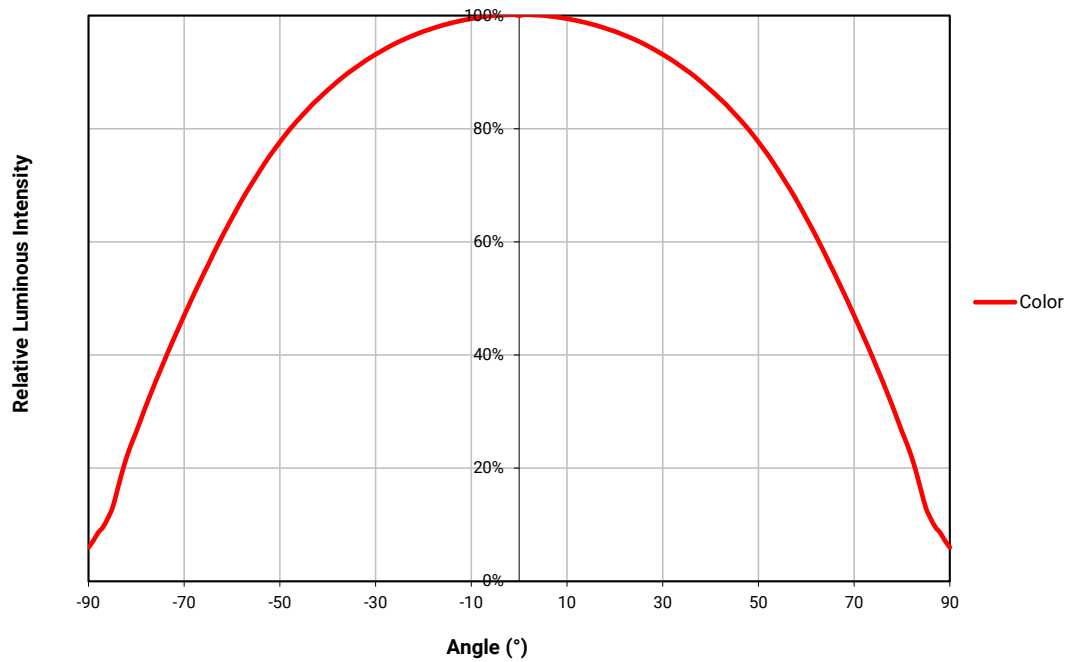

THERMAL DESIGN

The maximum forward current is determined by the thermal resistance between the LED junction and ambient. It is crucial for the end product to be designed in a manner that minimizes the thermal resistance from the solder point to ambient in order to optimize lamp life and optical characteristics.

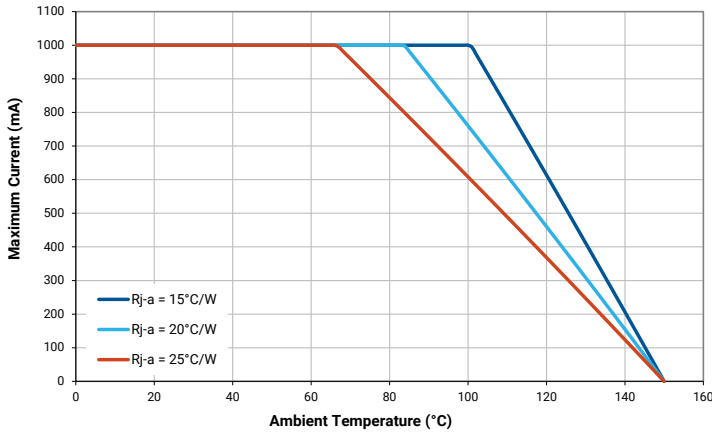

White

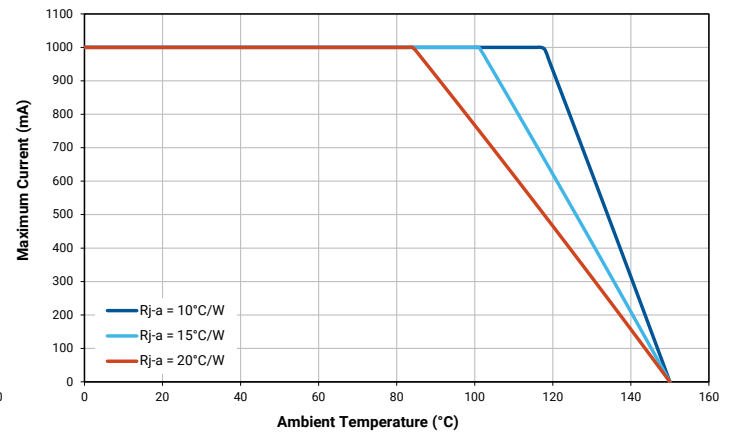

Blue

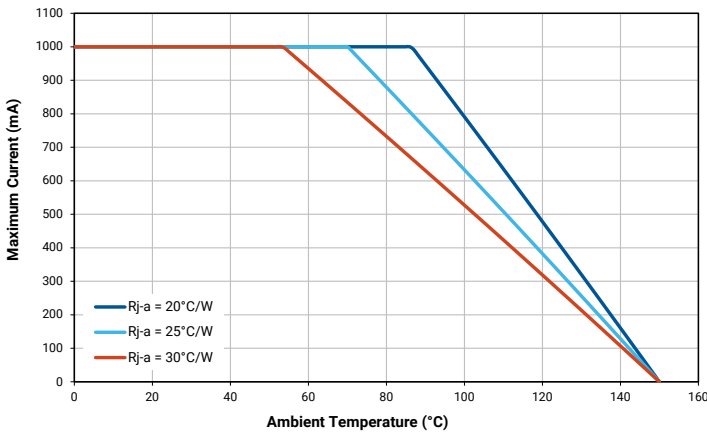

Green

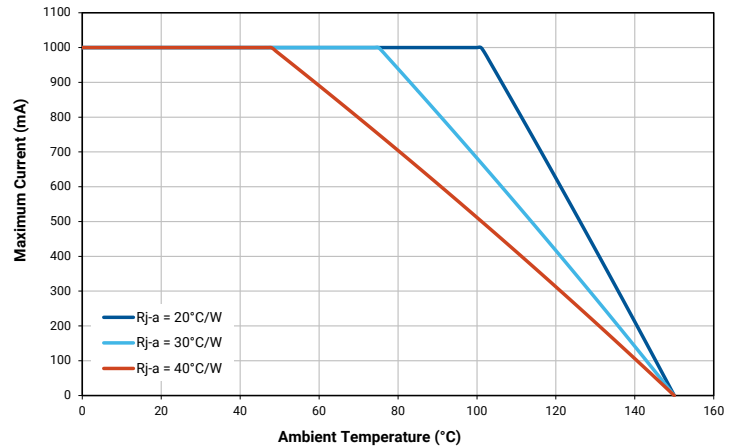

Amber

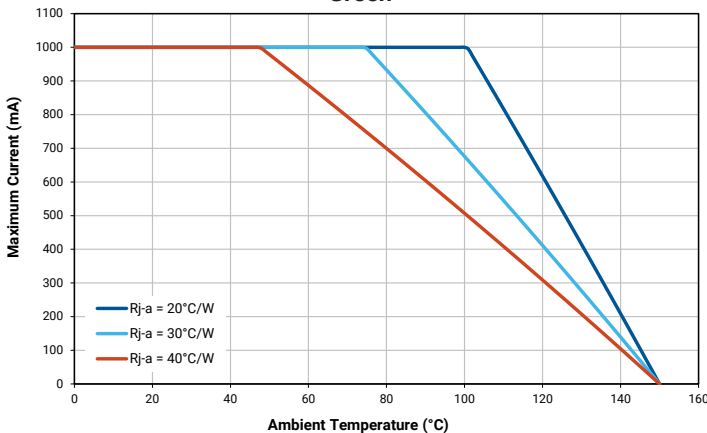

Red-Orange, Red

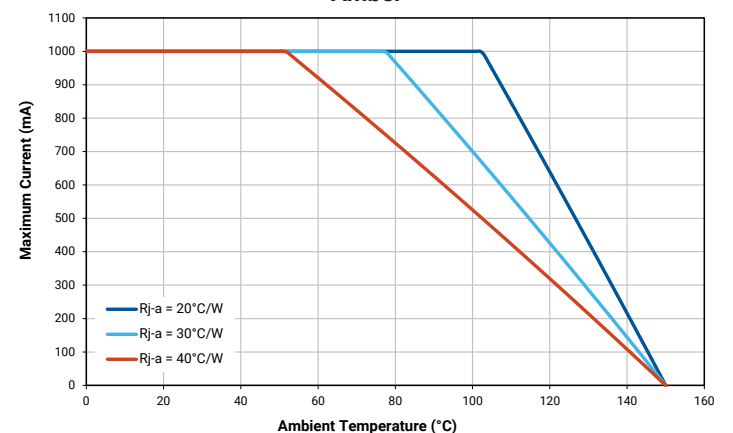

HE Photo Red

PERFORMANCE GROUPS - LUMINOUS FLUX

XLamp XP-E LEDs are tested for luminous flux and placed into one of the following luminous-flux groups:

Group Code	Minimum Luminous Flux (lm) @ 350 mA	Maximum Luminous Flux (lm) @ 350 mA
N3	56.8	62.0
N4	62.0	67.2
P2	67.2	73.9
P3	73.9	80.6
P4	80.6	87.4
Q2	87.4	93.9
Q3	93.9	100
Q4	100	107
Q5	107	114
R2	114	122
R3	122	130
R4	130	139
R5	139	148
S2	148	156
S3	156	164
S4	164	172
S5	172	180

PERFORMANCE GROUPS - RADIANT FLUX ($T_J = 25\text{ }^\circ\text{C}$)

XLamp XP-E HE photo red LEDs are tested for radiant flux and sorted into one of the following radiant-flux bins:

Group	Minimum Radiant Flux (mW) @ 350 mA	Maximum Radiant Flux (mW) @ 350 mA
26	350	375
27	375	400
28	400	425
29	425	450

PERFORMANCE GROUPS - CHROMATICITY

White XLamp XP-E LEDs are tested for chromaticity and placed into one of the regions defined by the bounding coordinates on the following pages.

Region	x	y	Region	x	y
WK	.283	.284	WF	.314	.355
	.295	.297		.316	.332
	.298	.288		.306	.322
	.287	.276		.301	.342
WA	.292	.306	WP	.317	.319
	.295	.297		.329	.330
	.283	.284		.329	.318
	.279	.291		.318	.308
WM	.295	.297	WD	.329	.345
	.308	.311		.329	.330
	.310	.300		.317	.319
	.298	.288		.316	.332
WB	.306	.322	WG	.329	.369
	.308	.311		.329	.345
	.295	.297		.316	.332
	.292	.306		.314	.355
WE	.301	.342	WJ	.329	.330
	.306	.322		.329	.345
	.292	.306		.346	.359
	.287	.321		.344	.342
WN	.308	.311	WH	.348	.384
	.317	.319		.346	.359
	.318	.308		.329	.345
	.310	.300		.329	.369
WC	.316	.332			
	.317	.319			
	.308	.311			
	.306	.322			

PERFORMANCE GROUPS - CHROMATICITY (CONTINUED)

Region	x	y	Region	x	y	Region	x	y	Region	x	y
0A	0.2950	0.2970	0B	0.2920	0.3060	0C	0.2984	0.3133	0D	0.2984	0.3133
	0.2920	0.3060		0.2895	0.3135		0.2962	0.3220		0.3048	0.3207
	0.2984	0.3133		0.2962	0.3220		0.3028	0.3304		0.3068	0.3113
	0.3009	0.3042		0.2984	0.3133		0.3048	0.3207		0.3009	0.3042
0R	0.2980	0.2880	0S	0.2895	0.3135	0T	0.2962	0.3220	0U	0.3037	0.2937
	0.2950	0.2970		0.2870	0.3210		0.2937	0.3312		0.3009	0.3042
	0.3009	0.3042		0.2937	0.3312		0.3005	0.3415		0.3068	0.3113
	0.3037	0.2937		0.2962	0.3220		0.3028	0.3304		0.3093	0.2993
1A	0.3048	0.3207	1B	0.3028	0.3304	1C	0.3115	0.3391	1D	0.3130	0.3290
	0.3130	0.3290		0.3115	0.3391		0.3205	0.3481		0.3213	0.3373
	0.3144	0.3186		0.3130	0.3290		0.3213	0.3373		0.3221	0.3261
	0.3068	0.3113		0.3048	0.3207		0.3130	0.3290		0.3144	0.3186
1R	0.3068	0.3113	1S	0.3005	0.3415	1T	0.3099	0.3509	1U	0.3144	0.3186
	0.3144	0.3186		0.3099	0.3509		0.3196	0.3602		0.3221	0.3261
	0.3161	0.3059		0.3115	0.3391		0.3205	0.3481		0.3231	0.3120
	0.3093	0.2993		0.3028	0.3304		0.3115	0.3391		0.3161	0.3059
2A	0.3215	0.3350	2B	0.3207	0.3462	2C	0.3290	0.3538	2D	0.3290	0.3417
	0.3290	0.3417		0.3290	0.3538		0.3376	0.3616		0.3371	0.3490
	0.3290	0.3300		0.3290	0.3417		0.3371	0.3490		0.3366	0.3369
	0.3222	0.3243		0.3215	0.3350		0.3290	0.3417		0.3290	0.3300
2R	0.3222	0.3243	2S	0.3196	0.3602	2T	0.3290	0.3690	2U	0.3290	0.3300
	0.3290	0.3300		0.3290	0.3690		0.3381	0.3762		0.3366	0.3369
	0.3290	0.3180		0.3290	0.3538		0.3376	0.3616		0.3361	0.3245
	0.3231	0.3120		0.3207	0.3462		0.3290	0.3538		0.3290	0.3180
3A	0.3371	0.3490	3B	0.3376	0.3616	3C	0.3463	0.3687	3D	0.3451	0.3554
	0.3451	0.3554		0.3463	0.3687		0.3551	0.3760		0.3533	0.3620
	0.3440	0.3427		0.3451	0.3554		0.3533	0.3620		0.3515	0.3487
	0.3366	0.3369		0.3371	0.3490		0.3451	0.3554		0.3440	0.3427
3R	0.3366	0.3369	3S	0.3381	0.3762						
	0.3440	0.3428		0.3480	0.3840						
	0.3429	0.3307		0.3463	0.3687						
	0.3361	0.3245		0.3376	0.3616						
4A	0.3530	0.3597	4B	0.3548	0.3736	4C	0.3641	0.3804	4D	0.3615	0.3659
	0.3615	0.3659		0.3641	0.3804		0.3736	0.3874		0.3702	0.3722
	0.3590	0.3521		0.3615	0.3659		0.3702	0.3722		0.3670	0.3578
	0.3512	0.3465		0.3530	0.3597		0.3615	0.3659		0.3590	0.3521
5A1	0.3670	0.3578	5A2	0.3686	0.3649	5A3	0.3744	0.3685	5A4	0.3726	0.3612
	0.3686	0.3649		0.3702	0.3722		0.3763	0.3760		0.3744	0.3685
	0.3744	0.3685		0.3763	0.3760		0.3825	0.3798		0.3804	0.3721
	0.3726	0.3612		0.3744	0.3685		0.3804	0.3721		0.3783	0.3646

PERFORMANCE GROUPS - CHROMATICITY (CONTINUED)

Region	x	y	Region	x	y	Region	x	y	Region	x	y
5B1	0.3702	0.3722	5B2	0.3719	0.3797	5B3	0.3782	0.3837	5B4	0.3763	0.3760
	0.3719	0.3797		0.3736	0.3874		0.3802	0.3916		0.3782	0.3837
	0.3782	0.3837		0.3802	0.3916		0.3869	0.3958		0.3847	0.3877
	0.3763	0.3760		0.3782	0.3837		0.3847	0.3877		0.3825	0.3798
5C1	0.3825	0.3798	5C2	0.3847	0.3877	5C3	0.3912	0.3917	5C4	0.3887	0.3836
	0.3847	0.3877		0.3869	0.3958		0.3937	0.4001		0.3912	0.3917
	0.3912	0.3917		0.3937	0.4001		0.4006	0.4044		0.3978	0.3958
	0.3887	0.3836		0.3912	0.3917		0.3978	0.3958		0.3950	0.3875
5D1	0.3783	0.3646	5D2	0.3804	0.3721	5D3	0.3863	0.3758	5D4	0.3840	0.3681
	0.3804	0.3721		0.3825	0.3798		0.3887	0.3836		0.3863	0.3758
	0.3863	0.3758		0.3887	0.3836		0.3950	0.3875		0.3924	0.3794
	0.3840	0.3681		0.3863	0.3758		0.3924	0.3794		0.3898	0.3716
6A1	0.3889	0.3690	6A2	0.3915	0.3768	6A3	0.3981	0.3800	6A4	0.3953	0.3720
	0.3915	0.3768		0.3941	0.3848		0.4010	0.3882		0.3981	0.3800
	0.3981	0.3800		0.4010	0.3882		0.4080	0.3916		0.4048	0.3832
	0.3953	0.3720		0.3981	0.3800		0.4048	0.3832		0.4017	0.3751
6B1	0.3941	0.3848	6B2	0.3968	0.3930	6B3	0.4040	0.3966	6B4	0.4010	0.3882
	0.3968	0.3930		0.3996	0.4015		0.4071	0.4052		0.4040	0.3966
	0.4040	0.3966		0.4071	0.4052		0.4146	0.4089		0.4113	0.4001
	0.4010	0.3882		0.4040	0.3966		0.4113	0.4001		0.4080	0.3916
6C1	0.4080	0.3916	6C2	0.4113	0.4001	6C3	0.4186	0.4037	6C4	0.4150	0.3950
	0.4113	0.4001		0.4146	0.4089		0.4222	0.4127		0.4186	0.4037
	0.4186	0.4037		0.4222	0.4127		0.4299	0.4165		0.4259	0.4073
	0.4150	0.3950		0.4186	0.4037		0.4259	0.4073		0.4221	0.3984
6D1	0.4017	0.3751	6D2	0.4048	0.3832	6D3	0.4116	0.3865	6D4	0.4082	0.3782
	0.4048	0.3832		0.4080	0.3916		0.4150	0.3950		0.4116	0.3865
	0.4116	0.3865		0.4150	0.3950		0.4221	0.3984		0.4183	0.3898
	0.4082	0.3782		0.4116	0.3865		0.4183	0.3898		0.4147	0.3814
7A1	0.4147	0.3814	7A2	0.4183	0.3898	7A3	0.4242	0.3919	7A4	0.4203	0.3833
	0.4183	0.3898		0.4221	0.3984		0.4281	0.4006		0.4242	0.3919
	0.4242	0.3919		0.4281	0.4006		0.4342	0.4028		0.4300	0.3939
	0.4203	0.3833		0.4242	0.3919		0.4300	0.3939		0.4259	0.3853
7B1	0.4221	0.3984	7B2	0.4259	0.4073	7B3	0.4322	0.4096	7B4	0.4281	0.4006
	0.4259	0.4073		0.4299	0.4165		0.4364	0.4188		0.4322	0.4096
	0.4322	0.4096		0.4364	0.4188		0.4430	0.4212		0.4385	0.4119
	0.4281	0.4006		0.4322	0.4096		0.4385	0.4119		0.4342	0.4028
7C1	0.4342	0.4028	7C2	0.4385	0.4119	7C3	0.4449	0.4141	7C4	0.4403	0.4049
	0.4385	0.4119		0.4430	0.4212		0.4496	0.4236		0.4449	0.4141
	0.4449	0.4141		0.4496	0.4236		0.4562	0.4260		0.4513	0.4164
	0.4403	0.4049		0.4449	0.4141		0.4513	0.4164		0.4465	0.4071

PERFORMANCE GROUPS - CHROMATICITY (CONTINUED)

Region	x	y	Region	x	y	Region	x	y	Region	x	y
7D1	0.4259	0.3853	7D2	0.4300	0.3939	7D3	0.4359	0.3960	7D4	0.4316	0.3873
	0.4300	0.3939		0.4342	0.4028		0.4403	0.4049		0.4359	0.3960
	0.4359	0.3960		0.4403	0.4049		0.4465	0.4071		0.4418	0.3981
	0.4316	0.3873		0.4359	0.3960		0.4418	0.3981		0.4373	0.3893
8A1	0.4373	0.3893	8A2	0.4418	0.3981	8A3	0.4475	0.3994	8A4	0.4428	0.3906
	0.4418	0.3981		0.4465	0.4071		0.4523	0.4085		0.4475	0.3994
	0.4475	0.3994		0.4523	0.4085		0.4582	0.4099		0.4532	0.4008
	0.4428	0.3906		0.4475	0.3994		0.4532	0.4008		0.4483	0.3919
8B1	0.4465	0.4071	8B2	0.4513	0.4164	8B3	0.4573	0.4178	8B4	0.4523	0.4085
	0.4513	0.4164		0.4562	0.4260		0.4624	0.4274		0.4573	0.4178
	0.4573	0.4178		0.4624	0.4274		0.4687	0.4289		0.4634	0.4193
	0.4523	0.4085		0.4573	0.4178		0.4634	0.4193		0.4582	0.4099
8C1	0.4582	0.4099	8C2	0.4634	0.4193	8C3	0.4695	0.4207	8C4	0.4641	0.4112
	0.4634	0.4193		0.4687	0.4289		0.4750	0.4304		0.4695	0.4207
	0.4695	0.4207		0.4750	0.4304		0.4813	0.4319		0.4756	0.4221
	0.4641	0.4112		0.4695	0.4207		0.4756	0.4221		0.4700	0.4126
8D1	0.4483	0.3919	8D2	0.4532	0.4008	8D3	0.4589	0.4021	8D4	0.4538	0.3931
	0.4532	0.4008		0.4582	0.4099		0.4641	0.4112		0.4589	0.4021
	0.4589	0.4021		0.4641	0.4112		0.4700	0.4126		0.4646	0.4034
	0.4538	0.3931		0.4589	0.4021		0.4646	0.4034		0.4593	0.3944

PERFORMANCE GROUPS - DOMINANT WAVELENGTH

Color XLamp XP-E LEDs are tested for dominant wavelength (DWL) and sorted into one of the DWL bins defined below.

Color	DWL Group	Minimum DWL (nm) @ 350 mA	Maximum DWL (nm) @ 350 mA
Blue	B3	465	470
	B4	470	475
	B5	475	480
	B6	480	485
Green	G2	520	525
	G3	525	530
	G4	530	535
Amber	A2	585	590
	A3	590	595
Red-Orange	O3	610	615
	O4	615	620
Red	R2	620	625
	R3	625	630

PERFORMANCE GROUPS - PEAK WAVELENGTH

XLamp XP-E HE photo red LEDs are tested for peak wavelength (PWL) and sorted into one of the PWL bins defined below.

Color	PWL Group	Minimum PWL (nm) @ 350 mA	Maximum PWL (nm) @ 350 mA
HE Photo Red	P2	650	655
	P3	655	660
	P4	660	665
	P5	665	670

PERFORMANCE GROUPS - FORWARD VOLTAGE

XLamp XP-E amber, red-orange and red LEDs are tested for forward voltage and sorted into one of the forward voltage bins defined below.

Forward Voltage Group	Minimum Forward Voltage (V) @ 350 mA	Maximum Forward Voltage (V) @ 350 mA
A	1.5	1.75
B	1.75	2.0
C	2.0	2.25
D	2.25	2.5
E	2.5	2.75
F	2.75	3.0
G	3.0	3.25
H	3.25	3.5
J	3.5	3.75

STANDARD COOL WHITE KITS PLOTTED ON ANSI STANDARD CHROMATICITY REGIONS

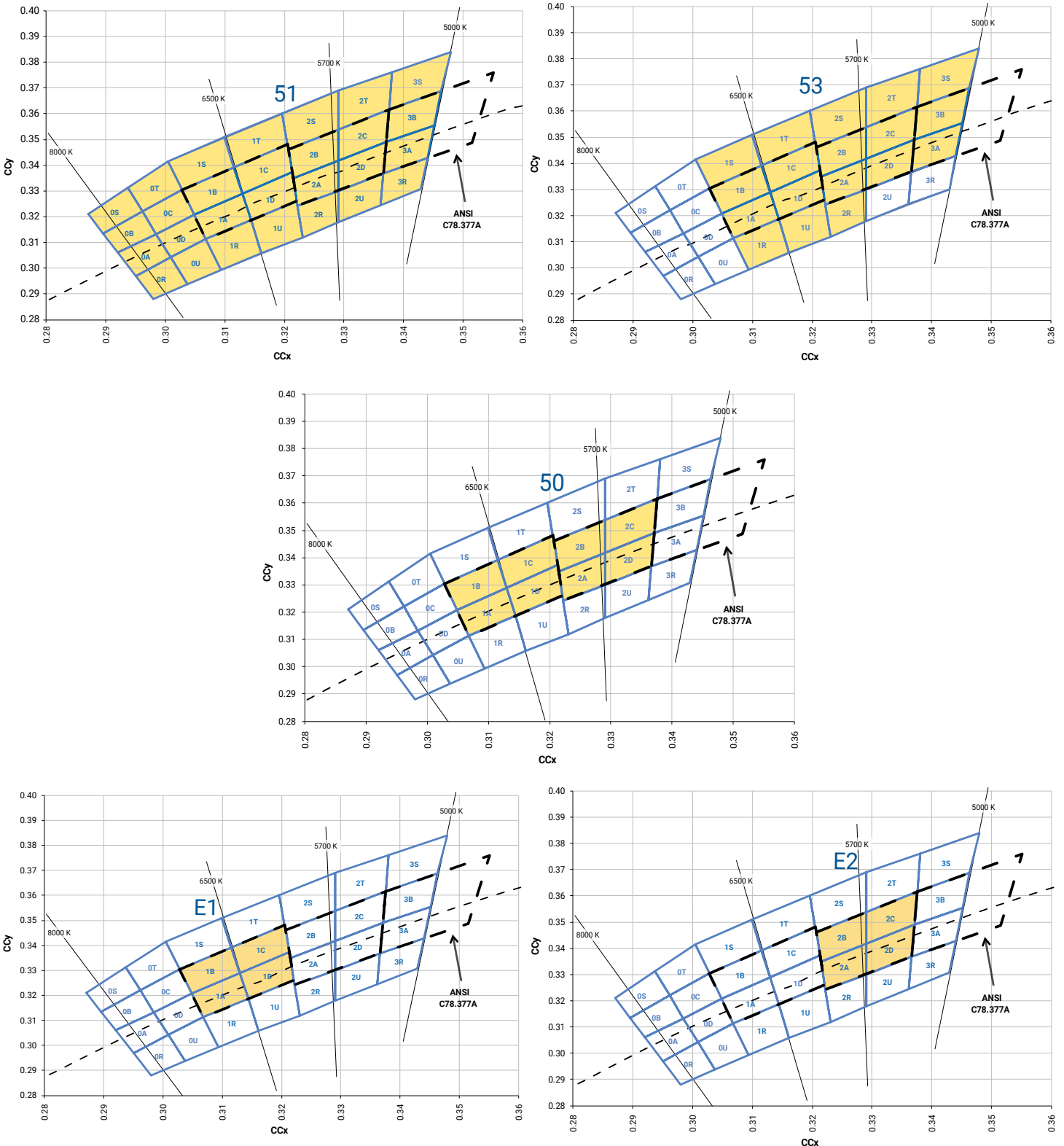

STANDARD WARM AND NEUTRAL WHITE KITS PLOTTED ON ANSI STANDARD CHROMATICITY REGIONS

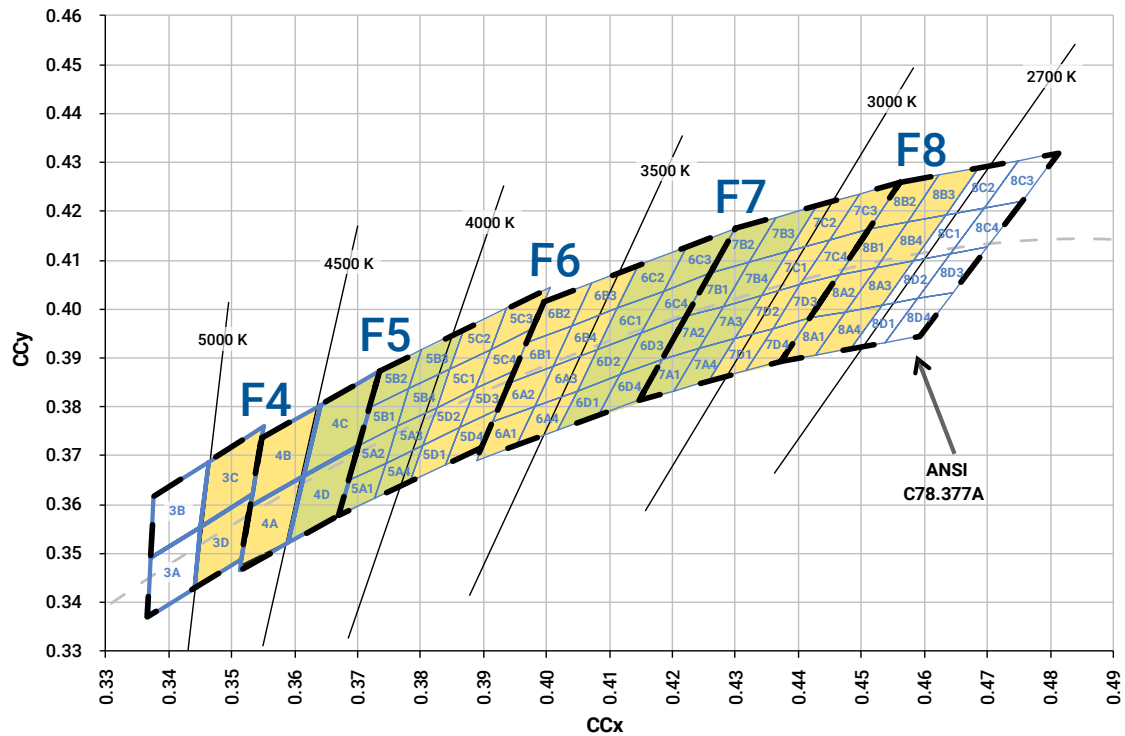
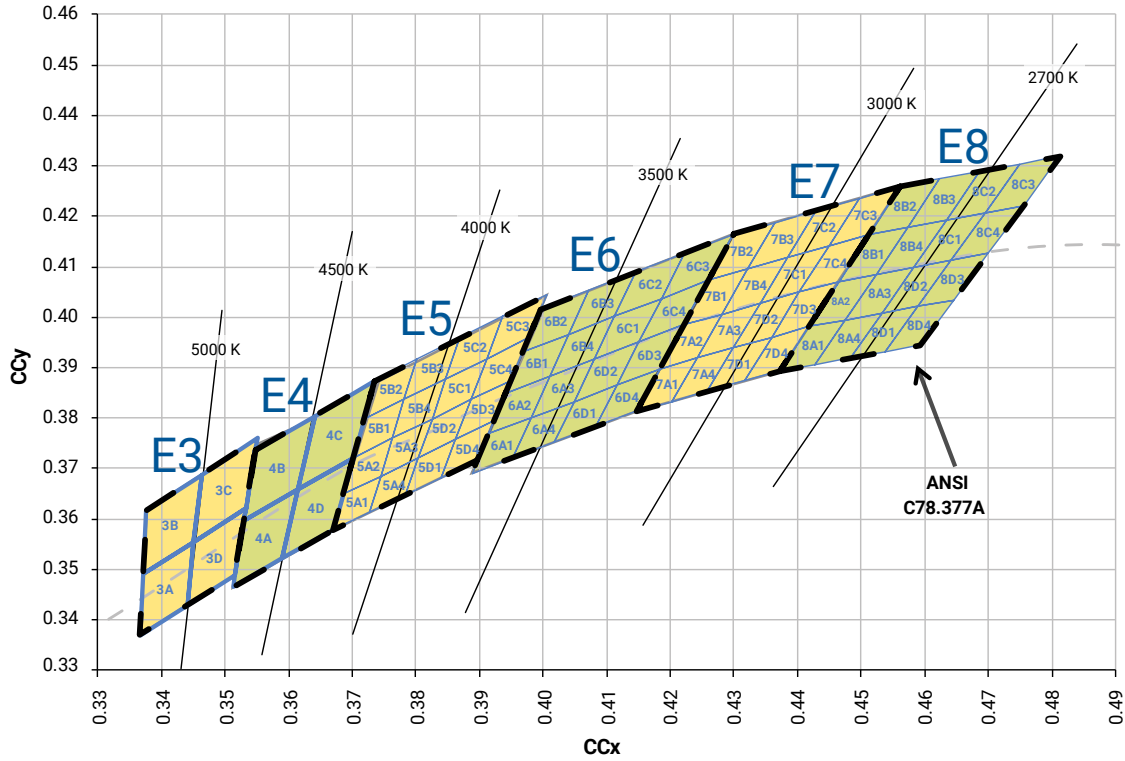

STANDARD WARM AND NEUTRAL WHITE KITS PLOTTED ON ANSI STANDARD CHROMATICITY REGIONS - CONTINUED

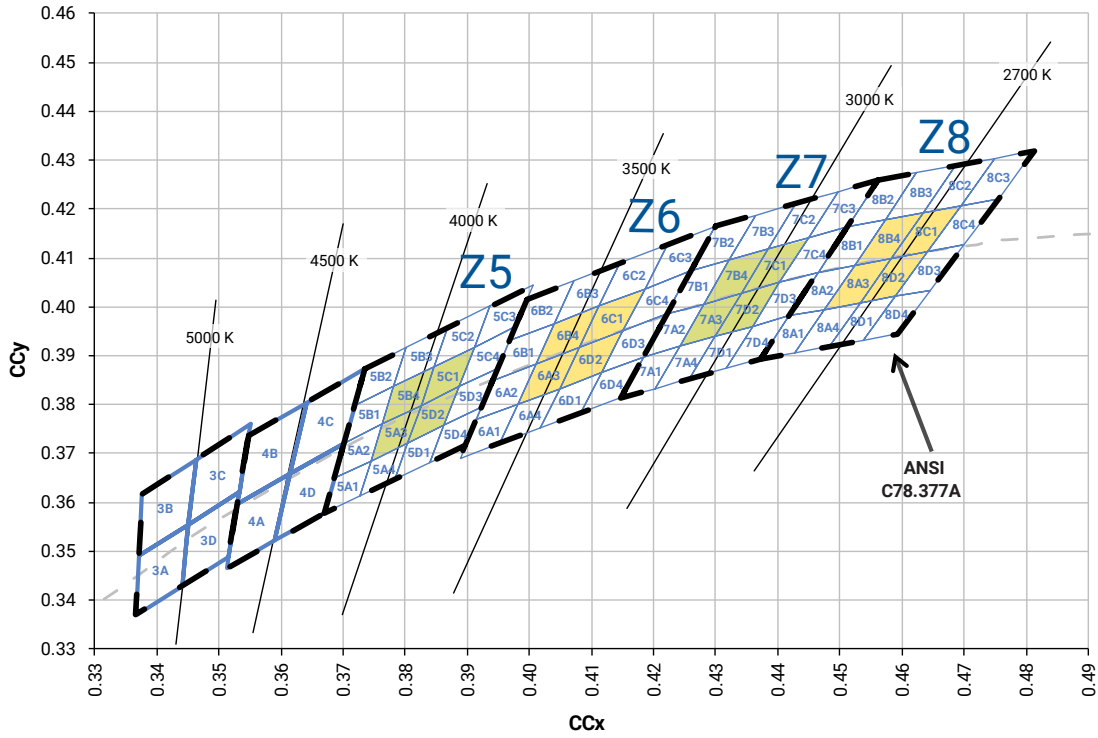

STANDARD CHROMATICITY KITS

The following table provides the chromaticity bins associated with chromaticity kits.

Color	CCT	Kit	Chromaticity Bins
Cool White	6200 K	51	0A, 0B, 0C, 0D, 0R, 0S, 0T, 0U, 1A, 1B, 1C, 1D, 1R, 1S, 1T, 1U, 2A, 2B, 2C, 2D, 2R, 2S, 2T, 2U, 3A, 3B, 3R, 3S
	6000 K	53	1A, 1B, 1C, 1D, 1R, 1S, 1T, 1U, 2A, 2B, 2C, 2D, 2R, 2S, 2T, 3A, 3B, 3S
	6200 K	50	1A, 1B, 1C, 1D, 2A, 2B, 2C, 2D
	6500 K	E1	1A, 1B, 1C, 1D
	5700 K	E2	2A, 2B, 2C, 2D
Neutral White	5000 K	E3	3A, 3B, 3C, 3D
	4750 K	F4	3C, 3D, 4A, 4B
	4500 K	E4	4A, 4B, 4C, 4D
	4250 K	F5	4C, 4D, 5A1, 5A2, 5A3, 5A4, 5B1, 5B2, 5B3, 5B4
	4000 K	E5	5A1, 5A2, 5A3, 5A4, 5B1, 5B2, 5B3, 5B4, 5C1, 5C2, 5C3, 5C4, 5D1, 5D2, 5D3, 5D4
	4000 K	Z5	5A3, 5B4, 5C1, 5D2
Warm White	3750 K	F6	5C1, 5C2, 5C3, 5C4, 5D1, 5D2, 5D3, 5D4, 6A1, 6A2, 6A3, 6A4, 6B1, 6B2, 6B3, 6B4
	3500 K	E6	6A1, 6A2, 6A3, 6A4, 6B1, 6B2, 6B3, 6B4, 6C1, 6C2, 6C3, 6C4, 6D1, 6D2, 6D3, 6D4
	3500 K	Z6	6A3, 6B4, 6C1, 6D2
	3250 K	F7	6C1, 6C2, 6C3, 6C4, 6D1, 6D2, 6D3, 6D4, 7A1, 7A2, 7A3, 7A4, 7B1, 7B2, 7B3, 7B4
	3000 K	E7	7A1, 7A2, 7A3, 7A4, 7B1, 7B2, 7B3, 7B4, 7C1, 7C2, 7C3, 7C4, 7D1, 7D2, 7D3, 7D4
	3000 K	Z7	7A3, 7B4, 7C1, 7D2
	2850 K	F8	7C1, 7C2, 7C3, 7C4, 7D1, 7D2, 7D3, 7D4, 8A1, 8A2, 8A3, 8A4, 8B1, 8B2, 8B3, 8B4
	2700 K	E8	8A1, 8A2, 8A3, 8A4, 8B1, 8B2, 8B3, 8B4, 8C1, 8C2, 8C3, 8C4, 8D1, 8D2, 8D3, 8D4
	2700 K	Z8	8A3, 8B4, 8C1, 8D2

BIN AND ORDER CODE FORMATS

XP-E bin codes and order codes are configured in the following manner:

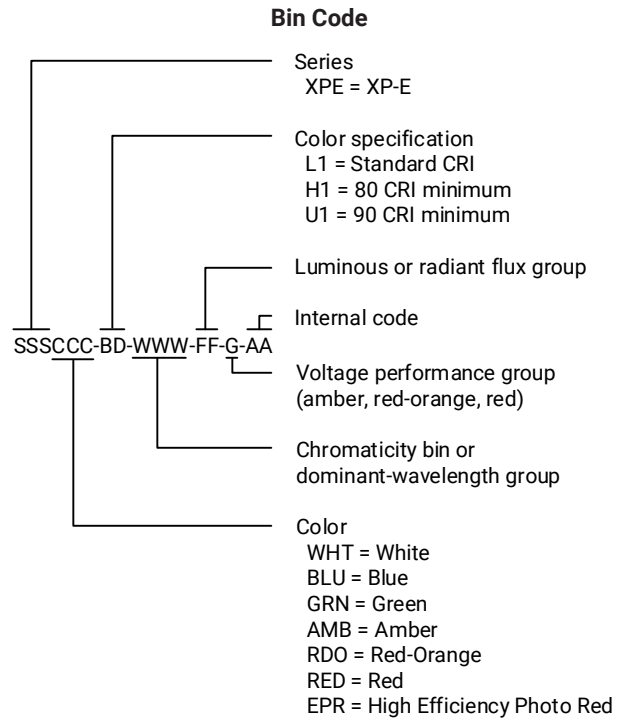
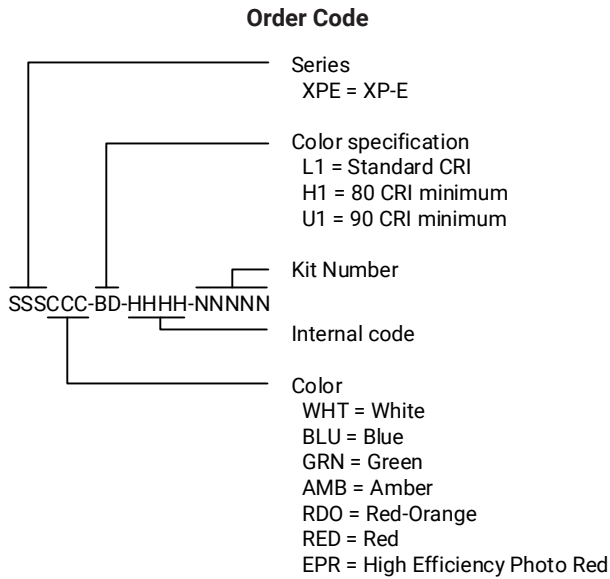

REFLOW SOLDERING CHARACTERISTICS

In testing, Cree LED has found XLamp XP-E LEDs to be compatible with JEDEC J-STD-020C, using the parameters listed below. As a general guideline, Cree LED recommends that users follow the recommended soldering profile provided by the manufacturer of the solder paste used, and therefore it is the lamp or luminaire manufacturer’s responsibility to determine applicable soldering requirements.

Note that this general guideline may not apply to all PCB designs and configurations of reflow soldering equipment.

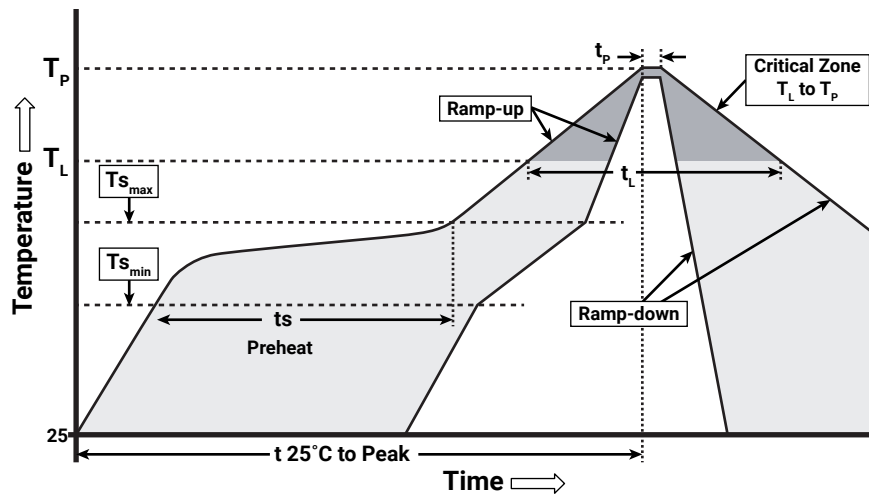

IPC/JEDEC J-STD-020C

Profile Feature	Lead-Free Solder
Average Ramp-Up Rate ($T_{s_{max}}$ to T_p)	1.2 °C/second
Preheat: Temperature Min ($T_{s_{min}}$)	120 °C
Preheat: Temperature Max ($T_{s_{max}}$)	170 °C
Preheat: Time ($t_{s_{min}}$ to $t_{s_{max}}$)	65-150 seconds
Time Maintained Above: Temperature (T_L)	217 °C
Time Maintained Above: Time (t_L)	45-90 seconds
Peak/Classification Temperature (T_p)	235 - 245 °C
Time Within 5 °C of Actual Peak Temperature (t_p)	20-40 seconds
Ramp-Down Rate	1 - 6 °C/second
Time 25 °C to Peak Temperature	4 minutes max.

Note: All temperatures refer to topside of the package, measured on the package body surface.

NOTES

Measurements

The luminous flux, radiant power, chromaticity, forward voltage and CRI measurements in this document are binning specifications only and solely represent product measurements as of the date of shipment. These measurements will change over time based on a number of factors that are not within Cree LED's control and are not intended or provided as operational specifications for the products. Calculated values are provided for informational purposes only and are not intended or provided as specifications.

Pre-Release Qualification Testing

Please read the [LED Reliability Overview](#) for details of the qualification process Cree LED applies to ensure long-term reliability for XLamp LEDs and details of Cree LED's pre-release qualification testing for XLamp LEDs.

Lumen Maintenance

Cree LED now uses standardized IES LM-80-08 and TM-21-11 methods for collecting long-term data and extrapolating LED lumen maintenance. For information on the specific LM-80 data sets available for this LED, refer to the public [LM-80 results document](#).

Please read the [Long-Term Lumen Maintenance application note](#) for more details on Cree LED's lumen maintenance testing and forecasting. Please read the [Thermal Management application note](#) for details on how thermal design, ambient temperature, and drive current affect the LED junction temperature.

Moisture Sensitivity

Cree LED recommends keeping XLamp LEDs in the provided, resealable moisture-barrier packaging (MBP) until immediately prior to soldering. Unopened MBPs that contain XLamp LEDs do not need special storage for moisture sensitivity.

Once the MBP is opened, XLamp XP-E LEDs may be stored as MSL 1 per JEDEC J-STD-033, meaning they have unlimited floor life in conditions of ≤ 30 °C/85% relative humidity (RH). Regardless of the storage condition, Cree LED recommends sealing any unsoldered LEDs in the original MBP.

RoHS Compliance

The levels of RoHS restricted materials in this product are below the maximum concentration values (also referred to as the threshold limits) permitted for such substances, or are used in an exempted application, in accordance with EU Directive 2011/65/EC (RoHS2), as implemented January 2, 2013. RoHS Declarations for this product can be obtained from your Cree LED representative or from the [Product Ecology](#) section of the Cree LED website.

REACH Compliance

REACH substances of very high concern (SVHCs) information is available for this product. Since the European Chemical Agency (ECHA) has published notice of their intent to frequently revise the SVHC listing for the foreseeable future, please contact a Cree LED representative to insure you get the most up-to-date REACH SVHC Declaration. REACH banned substance information (REACH Article 67) is also available upon request.

NOTES - CONTINUED

UL® Recognized Component

This product meets the requirements to be considered a UL Recognized Component with Level 4 enclosure consideration. The LED package or a portion thereof has been investigated as a fire and electrical enclosure per ANSI/UL 8750.

Vision Advisory

WARNING: Do not look at an exposed lamp in operation. Eye injury can result. For more information about LEDs and eye safety, please refer to the [LED Eye Safety application note](#).

Intellectual Property

For remote phosphor applications, a separate license to certain Cree LED patents is required.

MECHANICAL DIMENSIONS (T_A = 25 °C)

Thermal vias, if present, are not shown on these drawings.

All measurements are ±.13 mm unless otherwise indicated.

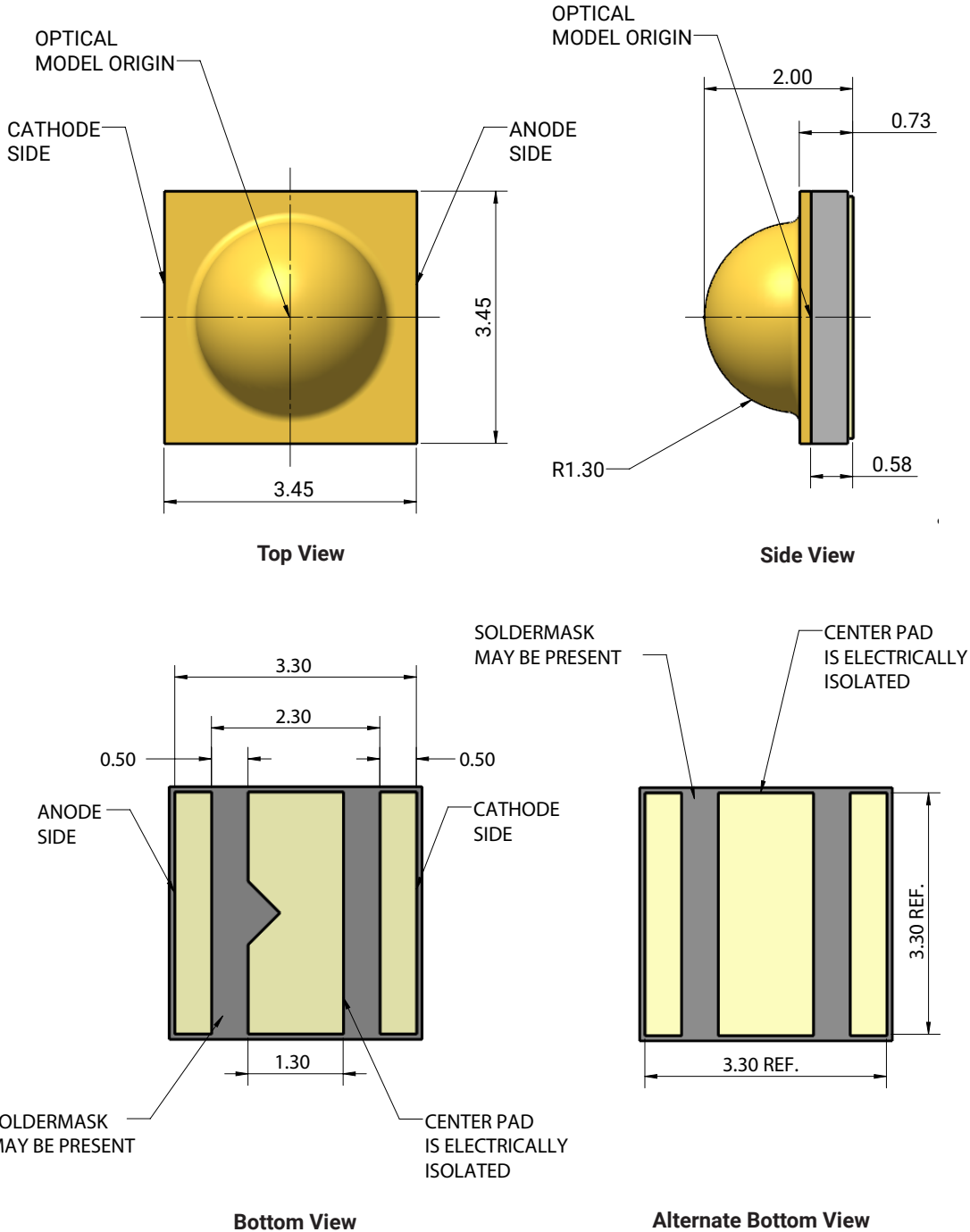

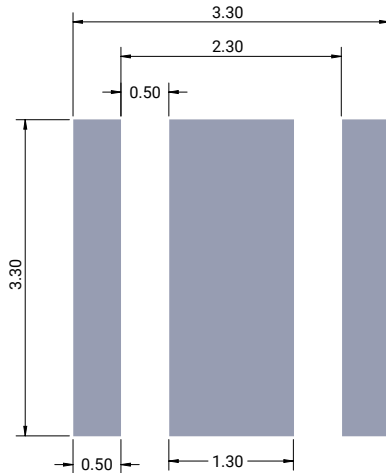
MECHANICAL DIMENSIONS ($T_A = 25\text{ }^\circ\text{C}$) - CONTINUED

Recommended PCB Footprint

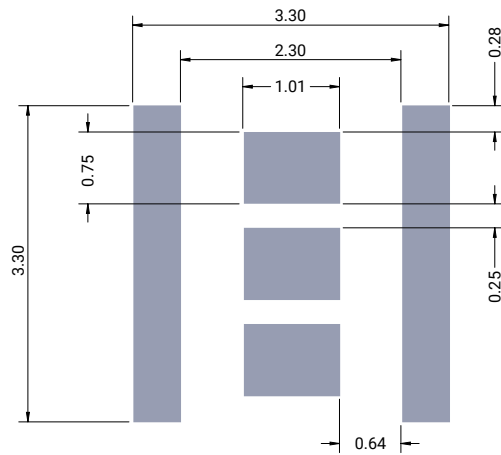

Recommended Stencil Openings*

Notes:

- Cree LED recommends using thermal pad kickouts to maximize component thermal performance.
- Cree LED recommends using white solder mask material to minimize system optical loss.
- * This stencil has been tested and optimized for the avoidance of voiding when using ALPHA® LUMET® P30 Maxrel solder paste. For other solder pastes, a "window pane" design for the thermal pad stencil may result in a lower voiding percentage. Contact your local Cree LED Field Applications Engineer for consultation regarding your specific application.

TAPE AND REEL

All Cree LED carrier tapes conform to EIA-481D, Automated Component Handling Systems Standard.

Except as noted, all dimensions in mm.

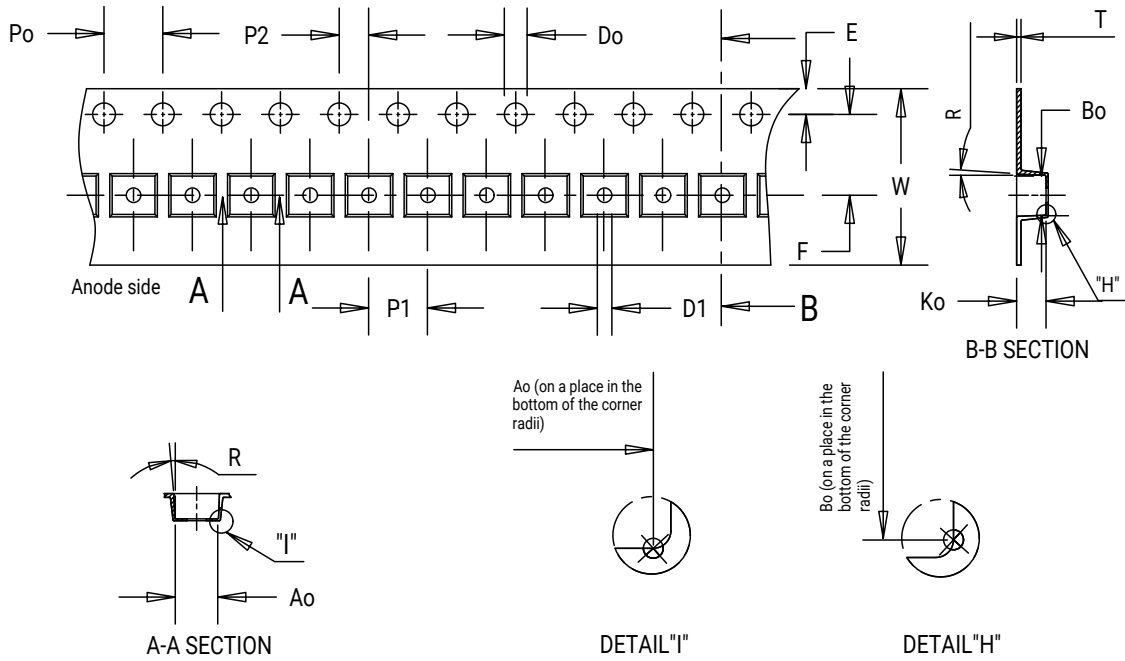

Item	Ao	Bo	Ko	Po	P1	P2	T	E	F	Do	D1	W	R
Dim.	3.75	3.75	2.10	4.00	8.00	2.00	0.30	1.75	5.50	1.50	1.50	12.00	8°

TAPE AND REEL - CONTINUED

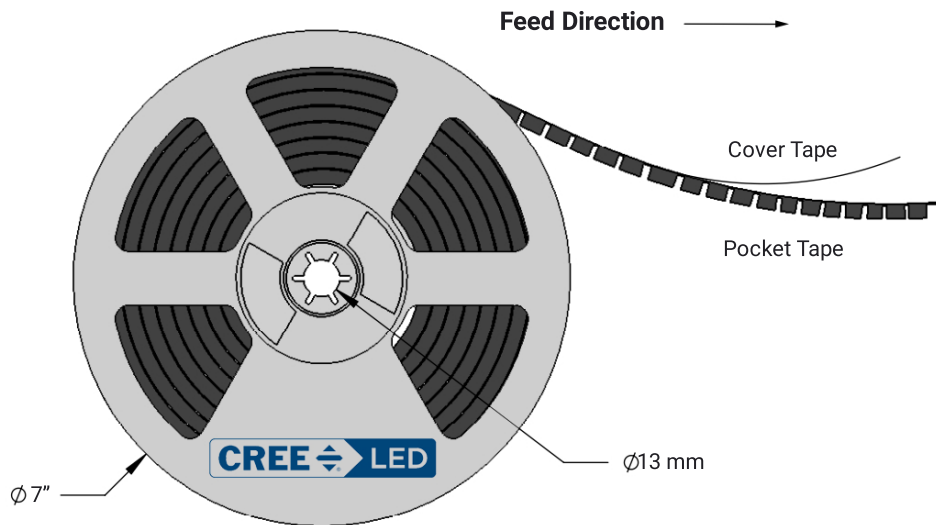
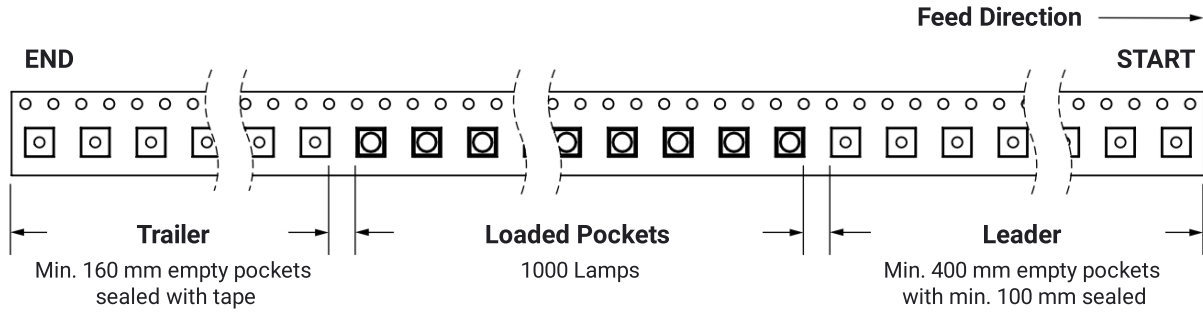

PACKAGING

Unpackaged Reel

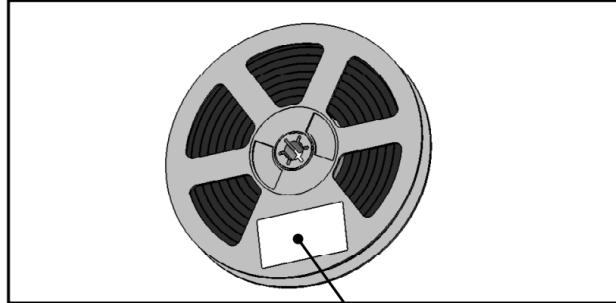

Label with Cree LED Bin Code, Quantity, Reel ID

Packaged Reel

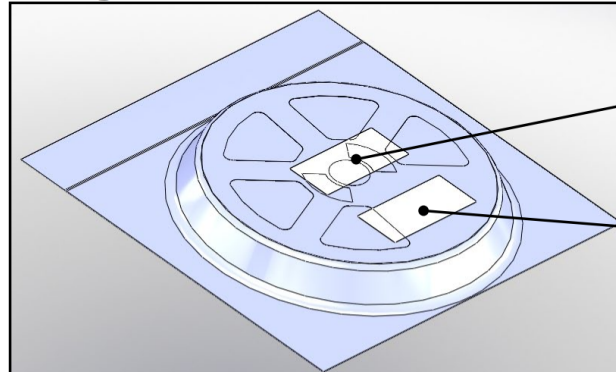

Label with Cree LED Order Code, Quantity, Reel ID, PO#

Label with Cree LED Bin Code, Quantity, Reel ID

Boxed Reel

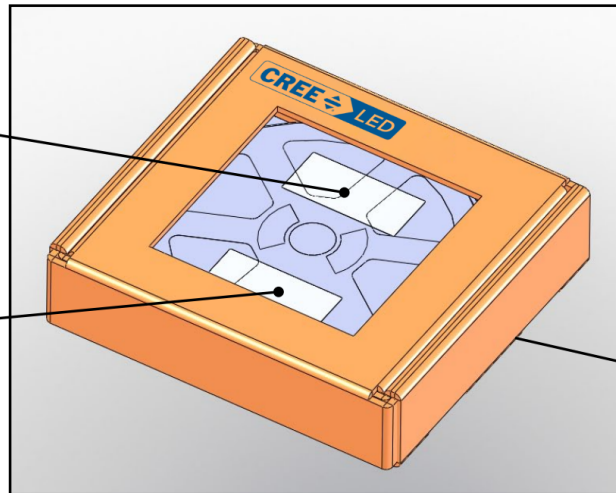

Label with Cree LED Order Code, Quantity, Reel ID, PO#

Label with Cree LED Bin Code, Quantity, Reel ID

Patent Label (on bottom of box)

APPENDIX - ORDER CODES NOT FOR NEW DESIGNS

The following order codes are active and valid order codes, but higher performance options are also available. Please see page 4 - page 8 for order codes of XLamp XP-E white LEDs that could serve as alternatives for the order codes set forth below.

XP-E White, $T_j = 25\text{ }^\circ\text{C}$

Minimum Luminous Flux (lm) @ 350 mA		Chromaticity Regions	Order Codes
Group	Flux (lm)		
Q4	100	WA, WB, WC, WD, WE, WF, WG, WH, WJ, WK, WM, WN, WP	XPEWHT-L1-0000-00C01
		WC, WD, WF, WG	XPEWHT-L1-0000-00C02
		WC, WD, WF, WG, WH, WJ, WN, WP	XPEWHT-L1-0000-00C03
Q5	107	WA, WB, WC, WD, WE, WF, WG, WH, WJ, WK, WM, WN, WP	XPEWHT-L1-0000-00D01
		WC, WD, WF, WG	XPEWHT-L1-0000-00D02
		WC, WD, WF, WG, WH, WJ, WN, WP	XPEWHT-L1-0000-00D03
R2	114	WA, WB, WC, WD, WE, WF, WG, WH, WJ, WK, WM, WN, WP	XPEWHT-L1-0000-00E01
		WC, WD, WF, WG	XPEWHT-L1-0000-00E02
		WC, WD, WF, WG, WH, WJ, WN, WP	XPEWHT-L1-0000-00E03
R3	122	WA, WB, WC, WD, WE, WF, WG, WH, WJ, WK, WM, WN, WP	XPEWHT-L1-0000-00F01
		WC, WD, WF, WG	XPEWHT-L1-0000-00F02
		WC, WD, WF, WG, WH, WJ, WN, WP	XPEWHT-L1-0000-00F03

Notes:

- Cree LED maintains a tolerance of $\pm 7\%$ on flux and power measurements, ± 0.005 on chromaticity (CCx, CCy) measurements and a tolerance of ± 2 on CRI measurements. See the Measurements section (page 34).
- XLamp XP-E LED order codes specify only a minimum flux bin and not a maximum. Cree LED may ship reels in flux bins higher than the minimum specified by the order code without advance notice. Shipments will always adhere to the chromaticity bin restrictions specified by the order code.

APPENDIX - ORDER CODES NOT FOR NEW DESIGNS - CONTINUED

Chromaticity		Minimum Luminous Flux (lm) @ 350 mA		Order Codes
Kit	CCT	Code	Flux (lm)	70 CRI Typical
51	6200 K	R3	122	XPEWHT-L1-0000-00F51
		R2	114	XPEWHT-L1-0000-00E51
		Q5	107	XPEWHT-L1-0000-00D51
		Q4	100	XPEWHT-L1-0000-00C51
53	6000 K	R3	122	XPEWHT-L1-0000-00F53
		R2	114	XPEWHT-L1-0000-00E53
		Q5	107	XPEWHT-L1-0000-00D53
		Q4	100	XPEWHT-L1-0000-00C53
50	6200 K	R3	122	XPEWHT-L1-0000-00F50
		R2	114	XPEWHT-L1-0000-00E50
		Q5	107	XPEWHT-L1-0000-00D50
		Q4	100	XPEWHT-L1-0000-00C50
E1	6500 K	R3	122	XPEWHT-L1-0000-00FE1
		R2	114	XPEWHT-L1-0000-00EE1
		Q5	107	XPEWHT-L1-0000-00DE1
		Q4	100	XPEWHT-L1-0000-00CE1
E2	5700 K	R3	122	XPEWHT-L1-0000-00FE2
		R2	114	XPEWHT-L1-0000-00EE2
		Q5	107	XPEWHT-L1-0000-00DE2
		Q4	100	XPEWHT-L1-0000-00CE2

Notes:

- Cree LED maintains a tolerance of $\pm 7\%$ on flux and power measurements, ± 0.005 on chromaticity (CCx, CCy) measurements and a tolerance of ± 2 on CRI measurements. See the Measurements section (page 34).
- XLamp XP-E LED order codes specify only a minimum flux bin and not a maximum. Cree LED may ship reels in flux bins higher than the minimum specified by the order code without advance notice. Shipments will always adhere to the chromaticity bin restrictions specified by the order code.

APPENDIX - ORDER CODES NOT FOR NEW DESIGNS - CONTINUED

Chromaticity		Minimum Luminous Flux (lm) @ 350 mA		Order Codes	
Kit	CCT	Code	Flux (lm)	75 CRI Typical	80 CRI Minimum
E3	5000 K	Q5	107	XPEWHT-L1-0000-00DE3	
		Q4	100	XPEWHT-L1-0000-00CE3	
		Q3	93.9	XPEWHT-L1-0000-00BE3	
F4	4750 K	Q5	107	XPEWHT-L1-0000-00DF4	
		Q4	100	XPEWHT-L1-0000-00CF4	
		Q3	93.9	XPEWHT-L1-0000-00BF4	
E4	4500 K	Q5	107	XPEWHT-L1-0000-00DE4	
		Q4	100	XPEWHT-L1-0000-00CE4	
		Q3	93.9	XPEWHT-L1-0000-00BE4	
F5	4250 K	Q5	107	XPEWHT-L1-0000-00DF5	
		Q4	100	XPEWHT-L1-0000-00CF5	
		Q3	93.9	XPEWHT-L1-0000-00BF5	
		Q2	87.4	XPEWHT-L1-0000-00AF5	
E5	4000 K	Q5	107	XPEWHT-L1-0000-00DE5	
		Q4	100	XPEWHT-L1-0000-00CE5	XPEWHT-H1-0000-00CE5
		Q3	93.9	XPEWHT-L1-0000-00BE5	XPEWHT-H1-0000-00BE5
		Q2	87.4	XPEWHT-L1-0000-00AE5	XPEWHT-H1-0000-00AE5
Z5	4000 K	Q4	100	XPEWHT-L1-0000-00CZ5	
		Q3	93.9	XPEWHT-L1-0000-00BZ5	XPEWHT-H1-0000-00BZ5
		Q2	87.4	XPEWHT-L1-0000-00AZ5	XPEWHT-H1-0000-00AZ5

Notes:

- Cree LED maintains a tolerance of ±7% on flux and power measurements, ±0.005 on chromaticity (CCx, CCy) measurements and a tolerance of ±2 on CRI measurements. See the Measurements section (page 34).
- XLamp XP-E LED order codes specify only a minimum flux bin and not a maximum. Cree LED may ship reels in flux bins higher than the minimum specified by the order code without advance notice. Shipments will always adhere to the chromaticity bin restrictions specified by the order code.

APPENDIX - ORDER CODES NOT FOR NEW DESIGNS - CONTINUED

Chromaticity		Minimum Luminous Flux (lm) @ 350 mA		Order Codes			
Kit	CCT	Code	Flux (lm)	80 CRI Typical	80 CRI Minimum	85 CRI Minimum	90 CRI Minimum
F6	3750 K	Q4	100	XPEWHT-L1-0000-00CF6			
		Q3	93.9	XPEWHT-L1-0000-00BF6	XPEWHT-H1-0000-00BF6		
		Q2	87.4	XPEWHT-L1-0000-00AF6	XPEWHT-H1-0000-00AF6		
		P4	80.6	XPEWHT-L1-0000-009F6	XPEWHT-H1-0000-009F6		
E6	3500 K	Q4	100	XPEWHT-L1-0000-00CE6			
		Q3	93.9	XPEWHT-L1-0000-00BE6	XPEWHT-H1-0000-00BE6		
		Q2	87.4	XPEWHT-L1-0000-00AE6	XPEWHT-H1-0000-00AE6		
		P4	80.6	XPEWHT-L1-0000-009E6	XPEWHT-H1-0000-009E6		
Z6	3500 K	Q3	93.9	XPEWHT-L1-0000-00BZ6			
		Q2	87.4	XPEWHT-L1-0000-00AZ6	XPEWHT-H1-0000-00AZ6		
		P4	80.6	XPEWHT-L1-0000-009Z6	XPEWHT-H1-0000-009Z6		
F7	3250 K	Q3	93.9	XPEWHT-L1-0000-00BF7			
		Q2	87.4	XPEWHT-L1-0000-00AF7	XPEWHT-H1-0000-00AF7		
		P4	80.6	XPEWHT-L1-0000-009F7	XPEWHT-H1-0000-009F7		
E7	3000 K	Q3	93.9	XPEWHT-L1-0000-00BE7			
		Q2	87.4	XPEWHT-L1-0000-00AE7	XPEWHT-H1-0000-00AE7		
		P4	80.6	XPEWHT-L1-0000-009E7	XPEWHT-H1-0000-009E7	XPEWHT-P1-0000-009E7	
		P3	73.9			XPEWHT-P1-0000-008E7	XPEWHT-U1-0000-008E7
		P2	67.2			XPEWHT-P1-0000-007E7	XPEWHT-U1-0000-007E7
		N4	62			XPEWHT-P1-0000-006E7	XPEWHT-U1-0000-006E7
Z7	3000 K	Q2	87.4	XPEWHT-L1-0000-00AZ7	XPEWHT-H1-0000-00AZ7		
		P4	80.6	XPEWHT-L1-0000-009Z7	XPEWHT-H1-0000-009Z7		
		P3	73.9			XPEWHT-P1-0000-008Z7	
		P2	67.2			XPEWHT-P1-0000-007Z7	XPEWHT-U1-0000-007Z7
		N4	62			XPEWHT-P1-0000-006Z7	XPEWHT-U1-0000-006Z7
F8	2850 K	Q2	87.4	XPEWHT-L1-0000-00AF8			
		P4	80.6	XPEWHT-L1-0000-009F8	XPEWHT-H1-0000-009F8		
		P3	73.9	XPEWHT-L1-0000-008F8	XPEWHT-H1-0000-008F8	XPEWHT-P1-0000-008F8	
		P2	67.2			XPEWHT-P1-0000-007F8	XPEWHT-U1-0000-007F8
		N4	62			XPEWHT-P1-0000-006F8	XPEWHT-U1-0000-006F8
		N3	56.8			XPEWHT-P1-0000-005F8	XPEWHT-U1-0000-005F8
E8	2700 K	Q2	87.4	XPEWHT-L1-0000-00AE8			
		P4	80.6	XPEWHT-L1-0000-009E8	XPEWHT-H1-0000-009E8		
		P3	73.9	XPEWHT-L1-0000-008E8	XPEWHT-H1-0000-008E8	XPEWHT-P1-0000-008E8	
		P2	67.2			XPEWHT-P1-0000-007E8	XPEWHT-U1-0000-007E8
		N4	62			XPEWHT-P1-0000-006E8	XPEWHT-U1-0000-006E8
		N3	56.8			XPEWHT-P1-0000-005E8	XPEWHT-U1-0000-005E8

Notes:

- Cree LED maintains a tolerance of ±7% on flux and power measurements, ±0.005 on chromaticity (CCx, CCy) measurements and a tolerance of ±2 on CRI measurements. See the Measurements section (page 34).
- XLamp XP-E LED order codes specify only a minimum flux bin and not a maximum. Cree LED may ship reels in flux bins higher than the minimum specified by the order code without advance notice. Shipments will always adhere to the chromaticity bin restrictions specified by the order code.

APPENDIX - ORDER CODES NOT FOR NEW DESIGNS - CONTINUED

Chromaticity		Minimum Luminous Flux (lm) @ 350 mA		Order Codes			
Kit	CCT	Code	Flux (lm)	80 CRI Typical	80 CRI Minimum	85 CRI Minimum	90 CRI Minimum
Z8	2700 K	P4	80.6	XPEWHT-L1-0000-009Z8	XPEWHT-H1-0000-009Z8		
		P3	73.9	XPEWHT-L1-0000-008Z8	XPEWHT-H1-0000-008Z8		
		P2	67.2			XPEWHT-P1-0000-007Z8	
		N4	62			XPEWHT-P1-0000-006Z8	XPEWHT-U1-0000-006Z8
		N3	56.8			XPEWHT-P1-0000-005Z8	XPEWHT-U1-0000-005Z8

Notes:

- Cree LED maintains a tolerance of ±7% on flux and power measurements, ±0.005 on chromaticity (CCx, CCy) measurements and a tolerance of ±2 on CRI measurements. See the Measurements section (page 34).
- XLamp XP-E LED order codes specify only a minimum flux bin and not a maximum. Cree LED may ship reels in flux bins higher than the minimum specified by the order code without advance notice. Shipments will always adhere to the chromaticity bin restrictions specified by the order code.

APPENDIX - ORDER CODES NOT FOR NEW DESIGNS - CONTINUED

The following order codes are active and valid order codes, but higher performance options are also available. Please see page 9 - page 10 for order codes of XLamp XP-E color LEDs that could serve as alternatives for the order codes set forth below.

Color	Minimum Luminous Flux (lm)@ 350 mA		Dominant Wavelength (nm)				Order Codes
			Minimum		Maximum		
	Group	Flux (lm)	Group	DWL (nm)	Group	DWL (nm)	
Blue	K2	30.6	B4	470	B5	480	XPEBLU-L1-0000-00Y05
	K3	35.2	B4	470	B5	480	XPEBLU-L1-0000-00Z05

Color	Minimum Luminous Flux (lm)@ 350 mA		Calculated Minimum PPF (μmol/s)	Dominant Wavelength (nm)				Order Codes
				Minimum		Maximum		
	Group	Flux (lm)		Group	DWL (nm)	Group	DWL (nm)	
Green	P4	80.6	0.74	G2	520	G4	535	XPEGRN-L1-0000-00901
				G2	520	G3	530	XPEGRN-L1-0000-00902
				G3	525	G4	535	XPEGRN-L1-0000-00903
	Q2	87.4	0.80	G2	520	G4	535	XPEGRN-L1-0000-00A01
				G2	520	G3	530	XPEGRN-L1-0000-00A02
				G3	525	G4	535	XPEGRN-L1-0000-00A03
	Q3	93.9	0.86	G2	520	G4	535	XPEGRN-L1-0000-00B01
				G2	520	G3	530	XPEGRN-L1-0000-00B02
				G3	525	G4	535	XPEGRN-L1-0000-00B03
	Q4	100	0.91	G2	520	G4	535	XPEGRN-L1-0000-00C01
				G2	520	G3	530	XPEGRN-L1-0000-00C02
				G3	525	G4	535	XPEGRN-L1-0000-00C03
	Q5	107	0.98	G2	520	G4	535	XPEGRN-L1-0000-00D01
				G2	520	G3	530	XPEGRN-L1-0000-00D02
				G3	525	G4	535	XPEGRN-L1-0000-00D03
	R2	114	1.04	G2	520	G4	535	XPEGRN-L1-0000-00E01
				G2	520	G3	530	XPEGRN-L1-0000-00E02
				G3	525	G4	535	XPEGRN-L1-0000-00E03
	R3	122	1.11	G2	520	G4	535	XPEGRN-L1-0000-00F01
				G2	520	G3	530	XPEGRN-L1-0000-00F02

Notes:

- Cree LED maintains a tolerance of ±7% on flux and power measurements, ±0.005 on chromaticity (CCx, CCy) measurements and a tolerance of ±2 on CRI measurements. See the Measurements section (page 34).
- XLamp XP-E LED order codes specify only a minimum flux bin and not a maximum. Cree LED may ship reels in flux bins higher than the minimum specified by the order code without advance notice. Shipments will always adhere to the chromaticity bin restrictions specified by the order code.