

**Singlemode
Build Out Attenuators**

Product Facts

- A range of fixed attenuation values. Standard values of 1 through 20 and 25dB
- UPC and APC offer Excellent Return Loss
- LC, SC, FC, ST, and D4 styles
- Attenuation is wavelength independent and polarization insensitive
- Low PDL
- Low modal noise
- High reliability
- Very low reflectance
- Vibration resistant
- Dual Window and Broadband Bandpass
- End face geometry per GR-326
- Designed to comply with Telcordia GR-910

Applications

- Power leveling in DWDM transmission systems
- Test and Measurement
- Power attenuation at the receiver

Available Collateral

- Test reports qualifying product to Telcordia GR-910 (2004)
- Application Specification 114-1129
- Installation/Cleaning Instruction Sheet 408-8895
- Product Specification 108-2099
- Customer Drawings

Attenuators



Tyco Electronics high performance Build Out Attenuators utilize a unique all-fiber construction to absorb the optical signal.

By employing a Tyco Electronics' technology, the design minimizes

reflectance, attenuation tolerance, and PDL while maximizing reliability, environmental stability, and power handling. There are no filters, air gaps, or core mismatches.

Specifications

- Attenuation Values** — 1-20dB and 25 dB (Fixed)
- Reflectance** — ≤ -55 and -65dB for UPC and APC polish, respectively
- Operating Temperature** — -40°C to +75°C
- Vibration Resistance** — < 0.1 x attenuation

Customizable Features

- Attenuation tolerance
- Attenuation values in 1dB increments
- Labeling
- Kitting/Packaging
- Wavelength Dependent Loss
- Reflectance:
 - UPC to -55 dB max.
 - APC to -65 dB max.

Attenuators (Continued)

**Singlemode
LC Attenuators, Build Out
Style, Fixed Value**

LC/UPC

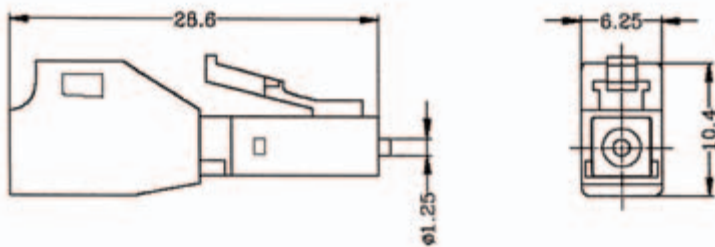

Note: Additional attenuation values available upon request.

**Broadband Bandpass Attenuators
Operating Wavelength
1260-1360nm & 1430-1625nm**

Attenuation (dB)	Part Number
1	1693560-1
2	1693560-2
3	1693560-3
4	1693560-4
5	1693560-5
6	1693560-6
7	1693560-7
8	1693560-8
9	1693560-9
10	1-1693560-0
11	1-1693560-1
12	1-1693560-2
13	1-1693560-3
14	1-1693560-4
15	1-1693560-5
16	1-1693560-6
17	1-1693560-7
18	1-1693560-8
19	1-1693560-9
20	2-1693560-0
25	2-1693560-5

Note: Attenuation Tolerance, Ambient
 ≥ 5 dB: ± .10 x nominal
 attenuation value
 < 5 dB: ± 0.50 dB
 Reflectance ≤ -55 dB

Note: Part Numbers are RoHS compliant
 except: ♦ Indicates non-RoHS
 compliant.

**Singlemode
SC Attenuators, Build Out
Style, Fixed Value**

SC/UPC

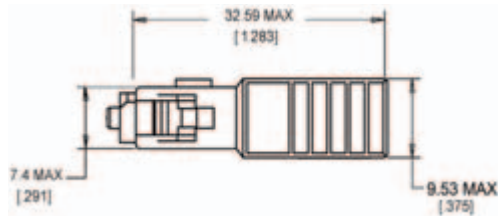

Note: Additional attenuation values available upon request.

**Dual Window Attenuators
Operating Wavelength
1310/1550nm ±25nm**

Attenuation (dB)	Part Number
0	9-5209943-9
1	5209943-1
2	5209943-2
3	5209943-3
4	5209943-4
5	5209943-5
6	5209943-6
7	5209943-7
8	5209943-8
9	5209943-9
10	1-5209943-0
11	1-5209943-1
12	1-5209943-2
13	1-5209943-3
14	1-5209943-4
15	1-5209943-5
16	1-5209943-6
17	1-5209943-7
18	1-5209943-8
19	1-5209943-9
20	2-5209943-0
25	2-5209943-5

Note: Attenuation Tolerance, Ambient
 ∅ 5 dB: ± .10 x nominal
 attenuation value
 < 5 dB: ± 0.50 dB
 0 dB: 0.50 dB max
 Reflectance ≤ -55 dB

**Broadband Bandpass Attenuators
Operating Wavelength
1260-1360nm & 1430-1625nm**

Attenuation (dB)	Part Number
0	9-5209250-9
1	5209250-1
2	5209250-2
3	5209250-3
4	5209250-4
5	5209250-5
6	5209250-6
7	5209250-7
8	5209250-8
9	5209250-9
10	1-5209250-0
11	1-5209250-1
12	1-5209250-2
13	1-5209250-3
14	1-5209250-4
15	1-5209250-5
16	1-5209250-6
17	1-5209250-7
18	1-5209250-8
19	1-5209250-9
20	2-5209250-0
25	2-5209250-5

Note: Attenuation Tolerance, Ambient
 ∅ 5 dB: ± .10 x nominal
 attenuation value
 < 5 dB: ± 0.50 dB
 0 dB: 0.50 dB max.
 Reflectance ≤ -55 dB

**Singlemode
SC Attenuators, Build Out
Style Fixed Value**

SC/APC 8°

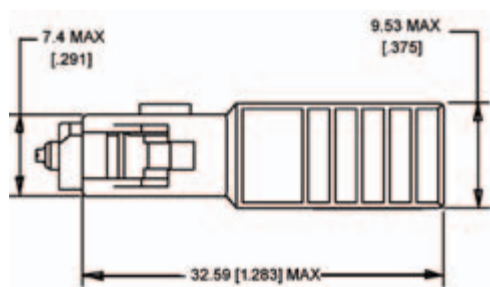

Note: Additional attenuation values available upon request.

* 9° APC Available (417496-X)

**Dual Window Attenuators
Operating Wavelength
1310/1550nm ±25nm**

Attenuation (dB)	Part Number
1	5209597-1
2	5209597-2
3	5209597-3
4	5209597-4
5	5209597-5
6	5209597-6
7	5209597-7
8	5209597-8
9	5209597-9
10	1-5209597-0
11	1-5209597-1
12	1-5209597-2
13	1-5209597-3
14	1-5209597-4
15	1-5209597-5
16	1-5209597-6
17	1-5209597-7
18	1-5209597-8
20	2-5209597-0
25	2-5209597-5

Note: Attenuation Tolerance, Ambient
 ∅ 5 dB: ± .10 x nominal
 attenuation value
 < 5 dB: ± 0.50 dB
 Reflectance ≤ -60 dB

**Broadband Bandpass Attenuators
Operating Wavelength
1260-1360nm & 1430-1625nm**

Attenuation (dB)	Part Number
1	5417021-1
2	5417021-2
3	5417021-3
4	5417021-4
5	5417021-5
6	5417021-6
7	5417021-7
8	5417021-8
9	5417021-9
10	1-5417021-0
11	1-5417021-1
12	1-5417021-2
13	1-5417021-3
14	1-5417021-4
15	1-5417021-5
16	1-5417021-6
17	1-5417021-7
18	1-5417021-8
19	1-5417021-9
20	2-5417021-0
25	2-5417021-5

Note: Attenuation Tolerance, Ambient
 ∅ 5 dB: ± .10 x nominal
 attenuation value
 < 5 dB: ± 0.50 dB
 Reflectance ≤ -65 dB

Note: Part Numbers are RoHS compliant except: ♦ Indicates non-RoHS compliant.

**Singlemode
FC Attenuators, Build Out
Style, Fixed Value**

FC/UPC

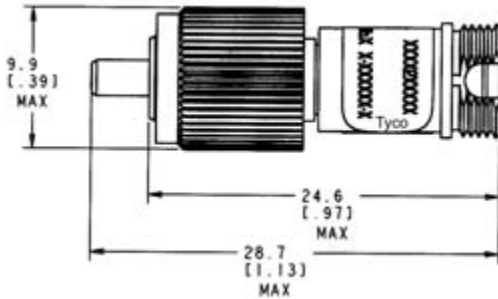

Note: Additional attenuation values available upon request.

**Dual Window Attenuators
Operating Wavelength
1310/1550nm ±25nm**

Attenuation (dB)	Part Number
1	5209948-1
2	5209948-2
3	5209948-3
4	5209948-4
5	5209948-5
6	5209948-6
7	5209948-7
8	5209948-8
9	5209948-9
10	1-5209948-0
11	1-5209948-1
12	1-5209948-2
13	1-5209948-3
14	1-5209948-4
15	1-5209948-5
16	1-5209948-6
17	1-5209948-7
18	1-5209948-8
19	1-5209948-9
20	2-5209948-0
25	2-5209948-5

Note: Attenuation Tolerance, Ambient
 ≥ 5 dB: ± .10 x nominal attenuation value
 < 5 dB: ± 0.50 dB
 Reflectance ≤ -55 dB

**Broadband Bandpass Attenuators
Operating Wavelength
1260-1360nm & 1430-1625nm**

Attenuation (dB)	Part Number
0	9-5209285-9
1	5209285-1
2	5209285-2
3	5209285-3
4	5209285-4
5	5209285-5
6	5209285-6
7	5209285-7
8	5209285-8
9	5209285-9
10	1-5209285-0
11	1-5209285-1
12	1-5209285-2
13	1-5209285-3
14	1-5209285-4
15	1-5209285-5
16	1-5209285-6
17	1-5209285-7
18	1-5209285-8
19	1-5209285-9
20	2-5209285-0
25	2-5209285-5

Note: Attenuation Tolerance, Ambient
 ≥ 5 dB: ± .10 x nominal attenuation value
 < 5 dB: ± 0.50 dB
 0 dB: 0.50 dB max.
 Reflectance ≤ -55 dB

**Singlemode
FC Attenuators, Build Out
Style, Fixed Value**

FC/APC (8°)

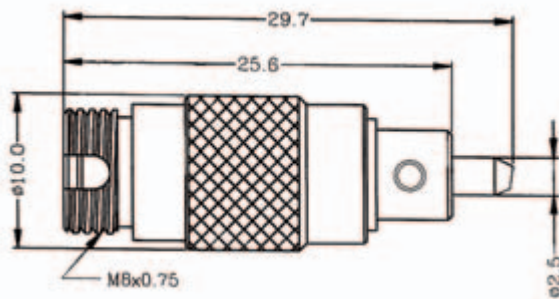

Note: Additional attenuation values available upon request.

**Dual Window Attenuators
Operating Wavelength
1310/1550nm ±25nm**

Attenuation (dB)	Part Number
1	1754722-1
2	1754722-2
3	1754722-3
4	1754722-4
5	1754722-5
6	1754722-6
10	1-1754722-0
12	1-1754722-2
15	1-1754722-5
18	1-1754722-8
20	2-1754722-0
25	2-1754722-5

Note: Attenuation Tolerance, Ambient
 ≥ 5 dB: ± .10 x nominal attenuation value
 < 5 dB: ± 0.50 dB
 Reflectance ≤ -65 dB

Note: Part Numbers are RoHS compliant except: ♦ Indicates non-RoHS compliant.

**Singlemode
ST Attenuators, Build Out
Style, Fixed Value**

ST/UPC

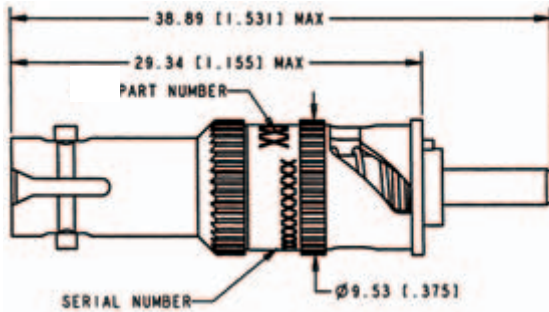

**Dual Window Attenuators
Operating Wavelength
1310/1550nm ±25nm**

Attenuation (dB)	Part Number
1	5417549-1
2	5417549-2
3	5417549-3
4	5417549-4
5	5417549-5
6	5417549-6
7	5417549-7
8	5417549-8
9	5417549-9
10	1-5417549-0
11	1-5417549-1
12	1-5417549-2
13	1-5417549-3
14	1-5417549-4
15	1-5417549-5
16	1-5417549-6
17	1-5417549-7
18	1-5417549-8
19	1-5417549-9
20	2-5417549-0
25	2-5417549-5

Note: Attenuation Tolerance, Ambient
 Ø 5 dB: ± .15 x nominal
 attenuation value
 < 5 dB: ± 0.75 dB
 Reflectance ≤ -55 dB

**Broadband Bandpass Attenuators
Operating Wavelength
1260-1360nm & 1430-1625nm**

Attenuation (dB)	Part Number
0	9-5417399-9
1	5417399-1
2	5417399-2
3	5417399-3
4	5417399-4
5	5417399-5
6	5417399-6
7	5417399-7
8	5417399-8
9	5417399-9
10	1-5417399-0
11	1-5417399-1
12	1-5417399-2
13	1-5417399-3
14	1-5417399-4
15	1-5417399-5
16	1-5417399-6
17	1-5417399-7
18	1-5417399-8
19	1-5417399-9
20	2-5417399-0
25	2-5417399-5

Note: Attenuation Tolerance, Ambient
 Ø 5 dB: ± .10 x nominal
 attenuation value
 < 5 dB: ± 0.50 dB
 0 dB: 0.50 dB max.
 Reflectance ≤ -55 dB

**Singlemode
D4 Attenuators, Build Out
Style, Fixed Value**

D4/PC

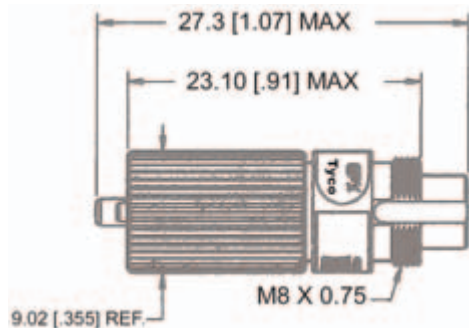

Note: Additional attenuation values
 available upon request.

**Dual Window Attenuators
Operating Wavelength
1310/1550nm ±25nm**

Attenuation (dB)	Part Number
5	5209570-5
10	1-5209570-0
15	1-5209570-5
20	2-5209570-0

Note: Attenuation Tolerance, Ambient
 Ø 5 dB: ± .15 x nominal
 attenuation value
 < 5 dB: ± 0.75 dB
 Reflectance ≤ -45 dB

Note: Part Numbers are RoHS compliant except: ♦ Indicates non-RoHS compliant.