

Small Signal Zener Diodes, Dual

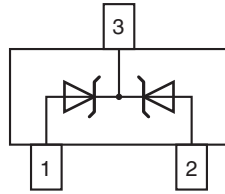

FEATURES

- Dual silicon planar Zener diodes, common cathode
- The Zener voltages are graded according to the international E24 standard. Standard Zener voltage tolerance is $\pm 5\%$.
- The parameters are valid for both diodes in one case. ΔV_Z and ΔR_{Zj} of the two diodes in one case is $\leq 5\%$
- AEC-Q101 qualified
- ESD capability according to AEC-Q101:
Human body model > 8 kV
Machine model > 800 V
- Base P/N-E3 - RoHS-compliant, commercial grade
- Base P/N-HE3 - RoHS-compliant, AEC-Q101 qualified
- Material categorization: For definitions of compliance please see www.vishay.com/doc?99912

RoHS
COMPLIANT

PRIMARY CHARACTERISTICS		
PARAMETER	VALUE	UNIT
V_Z range nom.	2.7 to 51	V
Test current I_{ZT}	5	mA
V_Z specification	Pulse current	
Int. construction	Dual common cathode	

ORDERING INFORMATION			
DEVICE NAME	ORDERING CODE	TAPED UNITS PER REEL	MINIMUM ORDER QUANTITY
DZ23-series	DZ23C2V7-E3-08 to DZ23C51-E3-08	3000 (8 mm tape on 7" reel)	15 000
	DZ23C2V7-HE3-08 to DZ23C51-HE3-08		
	DZ23C2V7-E3-18 to DZ23C51-E3-18	10 000 (8 mm tape on 13" reel)	10 000
	DZ23C2V7-HE3-18 to DZ23C51-HE3-18		

PACKAGE				
PACKAGE NAME	WEIGHT	MOLDING COMPOUND FLAMMABILITY RATING	MOISTURE SENSITIVITY LEVEL	SOLDERING CONDITIONS
SOT-23	8.8 mg	UL 94 V-0	MSL level 1 (according J-STD-020)	260 °C/10 s at terminals

ABSOLUTE MAXIMUM RATINGS ($T_{amb} = 25\text{ °C}$, unless otherwise specified)				
PARAMETER	TEST CONDITION	SYMBOL	VALUE	UNIT
Power dissipation	Device on fiberglass substrate, see layout on page 6	P_{tot}	300	mW
Thermal resistance, junction to ambient air	Device on fiberglass substrate, see layout on page 6	R_{thJA}	420	K/W
Junction temperature		T_j	150	°C
Storage temperature range		T_{stg}	- 65 to + 150	°C
Operating temperature range		T_{op}	- 55 to + 150	°C
Zener current		I_Z	P_{tot}/V_Z	mA



ELECTRICAL CHARACTERISTICS ($T_{amb} = 25\text{ }^{\circ}\text{C}$, unless otherwise specified)												
PART NUMBER	MARKING CODE	ZENER VOLTAGE RANGE ⁽¹⁾			TEST CURRENT		REVERSE VOLTAGE		DYNAMIC RESISTANCE $f = 1\text{ kHz}$		TEMPERATURE COEFFICIENT OF ZENER VOLTAGE	
		V_Z at I_{ZT1}			I_{ZT1}	I_{ZT2}	V_R at I_R		Z_Z at I_{ZT1}	Z_{ZK} at I_{ZT2}	α_{VZ} at I_{ZT1}	
		V			mA		V	nA	Ω		$10^{-4}/^{\circ}\text{C}$	
		MIN.	NOM.	MAX.			MAX.		MAX.	MAX.	MIN.	MAX.
DZ23C2V7	V1	2.5	2.7	2.9	5	1	-	-	75 (< 83)	< 500	- 9	- 4
DZ23C3V0	V2	2.8	3.0	3.2	5	1	-	-	80 (< 95)	< 500	- 9	- 3
DZ23C3V3	V3	3.1	3.3	3.5	5	1	-	-	80 (< 95)	< 500	- 8	- 3
DZ23C3V6	V4	3.4	3.6	3.8	5	1	-	-	80 (< 95)	< 500	- 8	- 3
DZ23C3V9	V5	3.7	3.9	4.1	5	1	-	-	80 (< 95)	< 500	- 7	- 3
DZ23C4V3	V6	4	4.3	4.6	5	1	-	-	80 (< 95)	< 500	- 6	- 1
DZ23C4V7	V7	4.4	4.7	5	5	1	-	-	70 (< 78)	< 500	- 5	2
DZ23C5V1	V8	4.8	5.1	5.4	5	1	> 0.8	100	30 (< 60)	< 480	- 3	4
DZ23C5V6	V9	5.2	5.6	6	5	1	> 1	100	10 (< 40)	< 400	- 2	6
DZ23C6V2	V10	5.8	6.2	6.6	5	1	> 2	100	4.8 (< 10)	< 200	- 1	7
DZ23C6V8	V11	6.4	6.8	7.2	5	1	> 3	100	4.5 (< 8)	< 150	2	7
DZ23C7V5	V12	7	7.5	7.9	5	1	> 5	100	4 (< 7)	< 50	3	7
DZ23C8V2	V13	7.7	8.2	8.7	5	1	> 6	100	4.5 (< 7)	< 50	4	7
DZ23C9V1	V14	8.5	9.1	9.6	5	1	> 7	100	4.8 (< 10)	< 50	5	8
DZ23C10	V15	9.4	10	10.6	5	1	> 7.5	100	5.2 (< 15)	< 70	5	8
DZ23C11	V16	10.4	11	11.6	5	1	> 8.5	100	6 (< 20)	< 70	5	9
DZ23C12	V17	11.4	12	12.7	5	1	> 9	100	7 (< 20)	< 90	6	9
DZ23C13	V18	12.4	13	14.1	5	1	> 10	100	9 (< 25)	< 110	7	9
DZ23C15	V19	13.8	15	15.6	5	1	> 11	100	11 (< 30)	< 110	7	9
DZ23C16	V20	15.3	16	17.1	5	1	> 12	100	13 (< 40)	< 170	8	9.5
DZ23C18	V21	16.8	18	19.1	5	1	> 14	100	18 (< 50)	< 170	8	9.5
DZ23C20	V22	18.8	20	21.2	5	1	> 15	100	20 (< 50)	< 220	8	10
DZ23C22	V23	20.8	22	23.3	5	1	> 17	100	25 (< 55)	< 220	8	10
DZ23C24	V24	22.8	24	25.6	5	1	> 18	100	28 (< 80)	< 220	8	10
DZ23C27	V25	25.1	27	28.9	5	1	> 20	100	30 (< 80)	< 250	8	10
DZ23C30	V26	28	30	32	5	1	> 22.5	100	35 (< 80)	< 250	8	10
DZ23C33	V27	31	33	35	5	1	> 25	100	40 (< 80)	< 250	8	10
DZ23C36	V28	34	36	38	5	1	> 27	100	40 (< 90)	< 250	8	10
DZ23C39	V29	37	39	41	5	1	> 29	100	50 (< 90)	< 300	10	12
DZ23C43	V30	40	43	46	5	1	> 32	100	60 (< 100)	< 700	10	12
DZ23C47	V31	44	47	50	5	1	> 35	100	70 (< 100)	< 750	10	12
DZ23C51	V32	48	51	54	5	1	> 38	100	70 (< 100)	< 750	10	12

Note

(1) Tested with pulses $t_p = 5\text{ ms}$

TYPICAL CHARACTERISTICS ($T_{amb} = 25\text{ }^{\circ}\text{C}$, unless otherwise specified)

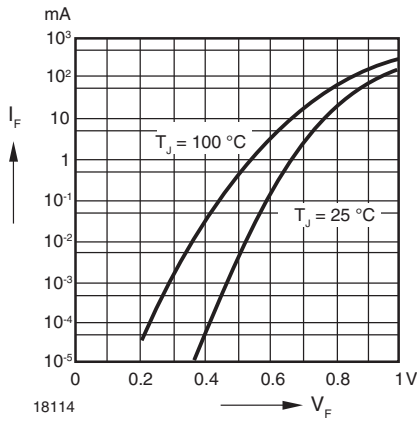

Fig. 1 - Forward Characteristics

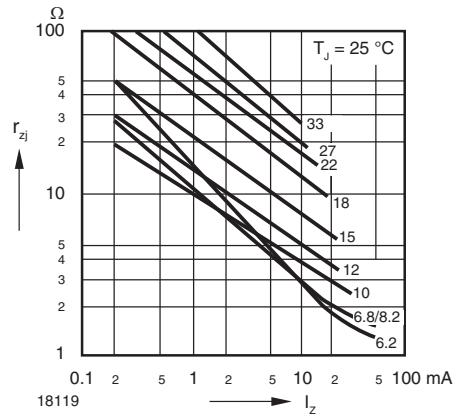

Fig. 4 - Dynamic Resistance vs. Zener Current

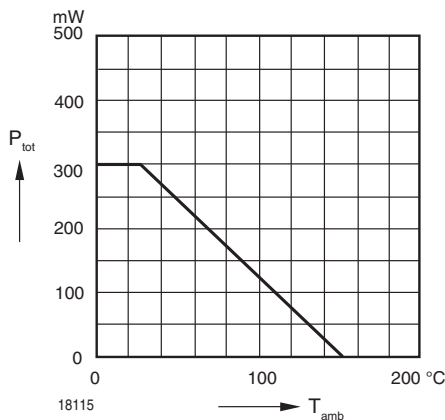

Fig. 2 - Admissible Power Dissipation vs. Ambient Temperature

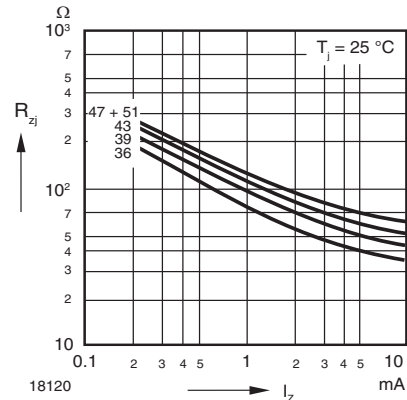

Fig. 5 - Dynamic Resistance vs. Zener Current

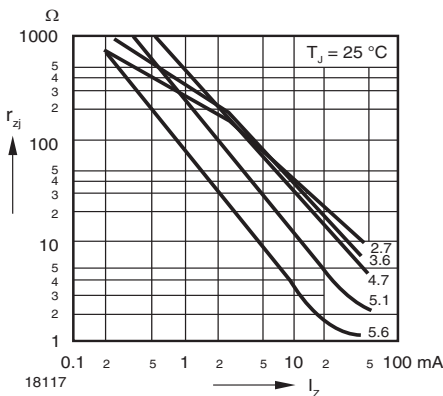

Fig. 3 - Dynamic Resistance vs. Zener Current

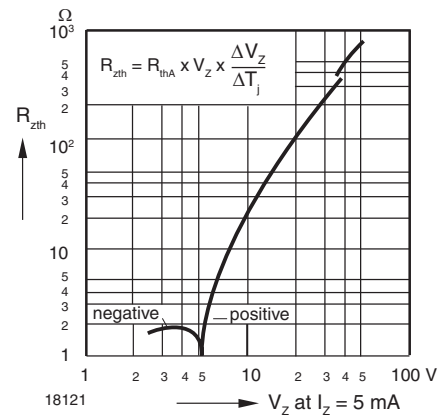

Fig. 6 - Thermal Differential Resistance vs. Zener Voltage

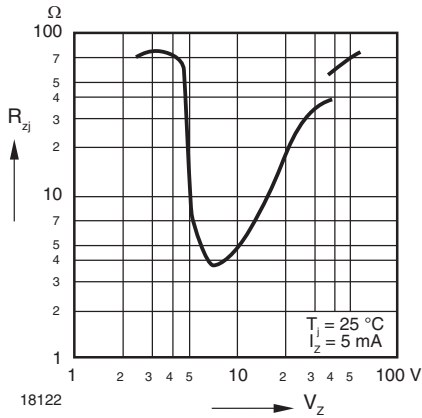

Fig. 7 - Dynamic Resistance vs. Zener Voltage

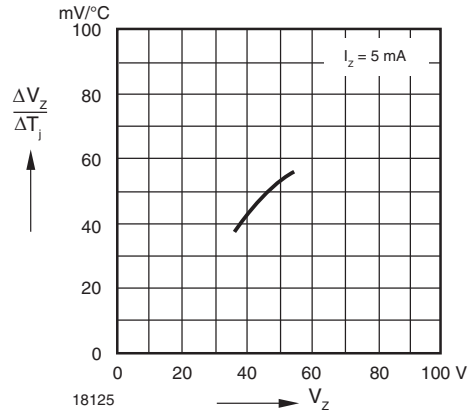

Fig. 10 - Temperature Dependence of Zener Voltage vs. Zener Voltage

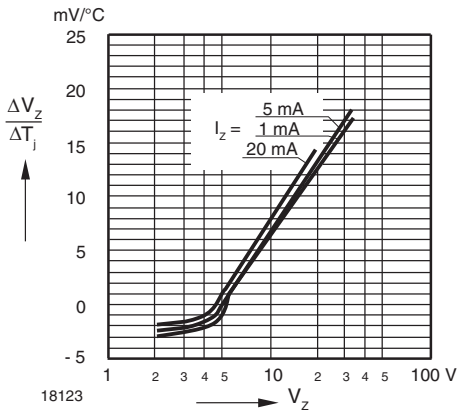

Fig. 8 - Temperature Dependence of Zener Voltage vs. Zener Voltage

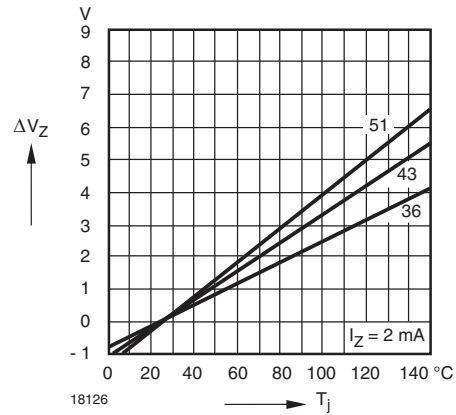

Fig. 11 - Change of Zener Voltage vs. Junction Temperature

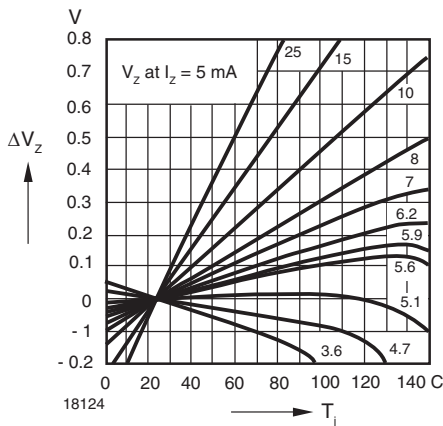

Fig. 9 - Change of Zener Voltage vs. Junction Temperature

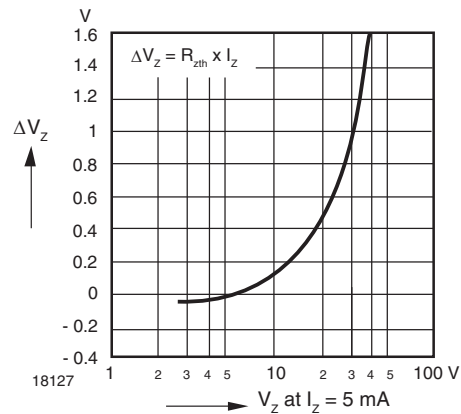

Fig. 12 - Change of Zener Voltage from Turn-on to the Point of Thermal Equilibrium vs. Zener voltage

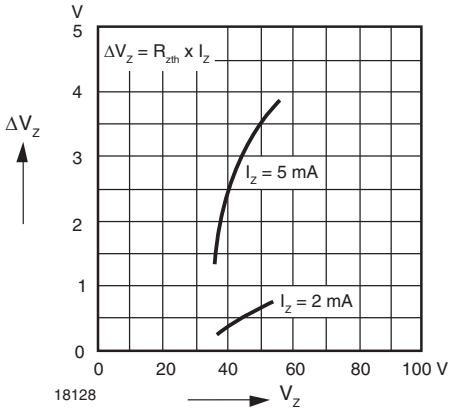

Fig. 13 - Change of Zener Voltage from Turn-on up to the Point of Thermal Equilibrium vs. Zener voltage

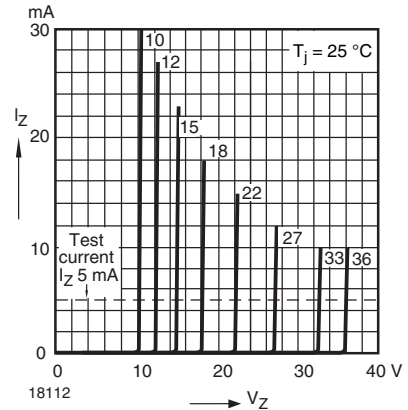

Fig. 15 - Breakdown Characteristics

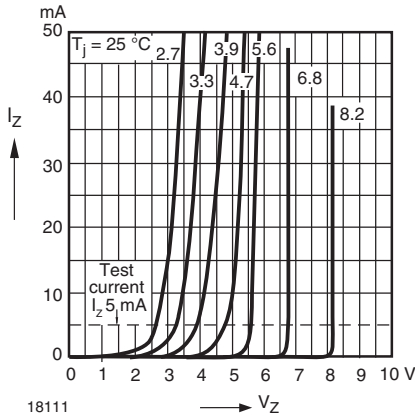

Fig. 14 - Breakdown Characteristics

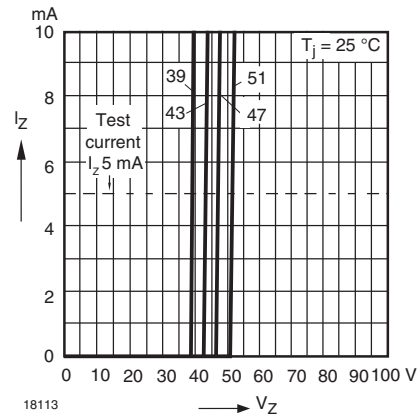
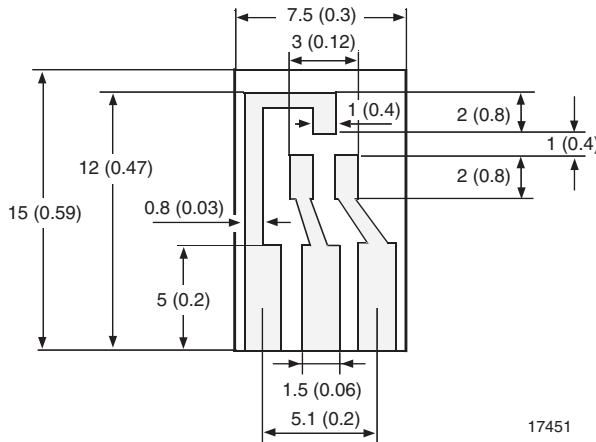

Fig. 16 - Breakdown Characteristics

LAYOUT FOR R_{thJA} TEST

Thickness: fiberglass 0.059" (1.5 mm)
Copper leads 0.012" (0.3 mm)





PACKAGE DIMENSIONS in millimeters (inches): **SOT-23**

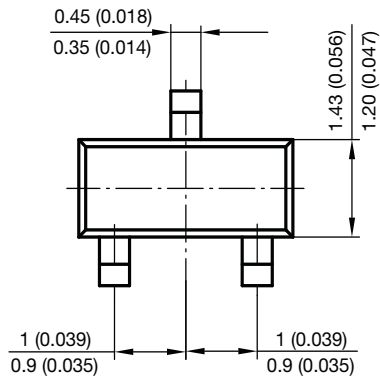
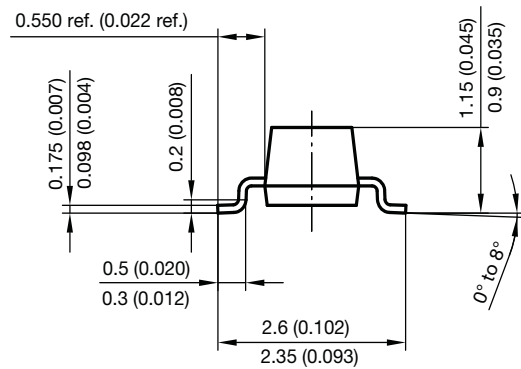
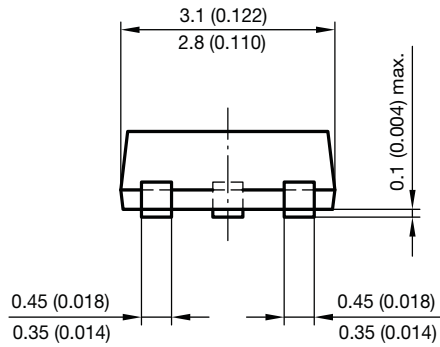

Foot print recommendation:

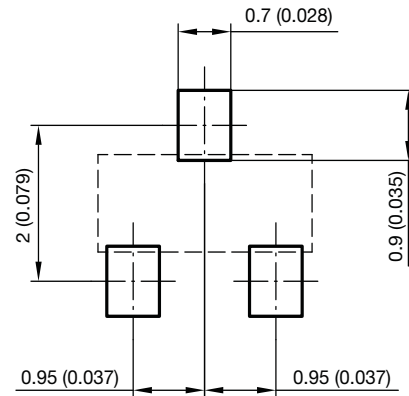

Document no.: 6.541-5014.01-4
Rev. 8 - Date: 23.Sept.2009
17418



Disclaimer

ALL PRODUCT, PRODUCT SPECIFICATIONS AND DATA ARE SUBJECT TO CHANGE WITHOUT NOTICE TO IMPROVE RELIABILITY, FUNCTION OR DESIGN OR OTHERWISE.

Vishay Intertechnology, Inc., its affiliates, agents, and employees, and all persons acting on its or their behalf (collectively, "Vishay"), disclaim any and all liability for any errors, inaccuracies or incompleteness contained in any datasheet or in any other disclosure relating to any product.

Vishay makes no warranty, representation or guarantee regarding the suitability of the products for any particular purpose or the continuing production of any product. To the maximum extent permitted by applicable law, Vishay disclaims (i) any and all liability arising out of the application or use of any product, (ii) any and all liability, including without limitation special, consequential or incidental damages, and (iii) any and all implied warranties, including warranties of fitness for particular purpose, non-infringement and merchantability.

Statements regarding the suitability of products for certain types of applications are based on Vishay's knowledge of typical requirements that are often placed on Vishay products in generic applications. Such statements are not binding statements about the suitability of products for a particular application. It is the customer's responsibility to validate that a particular product with the properties described in the product specification is suitable for use in a particular application. Parameters provided in datasheets and / or specifications may vary in different applications and performance may vary over time. All operating parameters, including typical parameters, must be validated for each customer application by the customer's technical experts. Product specifications do not expand or otherwise modify Vishay's terms and conditions of purchase, including but not limited to the warranty expressed therein.

Hyperlinks included in this datasheet may direct users to third-party websites. These links are provided as a convenience and for informational purposes only. Inclusion of these hyperlinks does not constitute an endorsement or an approval by Vishay of any of the products, services or opinions of the corporation, organization or individual associated with the third-party website. Vishay disclaims any and all liability and bears no responsibility for the accuracy, legality or content of the third-party website or for that of subsequent links.

Except as expressly indicated in writing, Vishay products are not designed for use in medical, life-saving, or life-sustaining applications or for any other application in which the failure of the Vishay product could result in personal injury or death. Customers using or selling Vishay products not expressly indicated for use in such applications do so at their own risk. Please contact authorized Vishay personnel to obtain written terms and conditions regarding products designed for such applications.

No license, express or implied, by estoppel or otherwise, to any intellectual property rights is granted by this document or by any conduct of Vishay. Product names and markings noted herein may be trademarks of their respective owners.