



GENERAL DESCRIPTION

KYOCERA AVX's new PrizmaCap capacitors, or SCP Series, are prismatic EDLCs (supercapacitors). The SCP Series provides the lowest profile & widest operating temperature available in KYOCERA AVX SuperCapacitors. Used by themselves or in conjunction with primary or secondary batteries, they provide extended backup time, longer battery life, and provide instantaneous power pulses as needed. They are best used in applications requiring pulse power handling, energy storage, energy/power holdup, and battery assist.

FEATURES

- Larger Capacitance in Prismatic Form Factor
- Widest Temperature Rating
- Low Profile & Light Weight
- Custom Design Capabilities

APPLICATIONS

- Wearables
- Handhelds
- High Temp Industrial
- Bluetooth Keyboard
- Battery Assist
- Power Peripherals
- Tablet/E-Reader
- High Reliability
- Space Constrained Designs

HOW TO ORDER

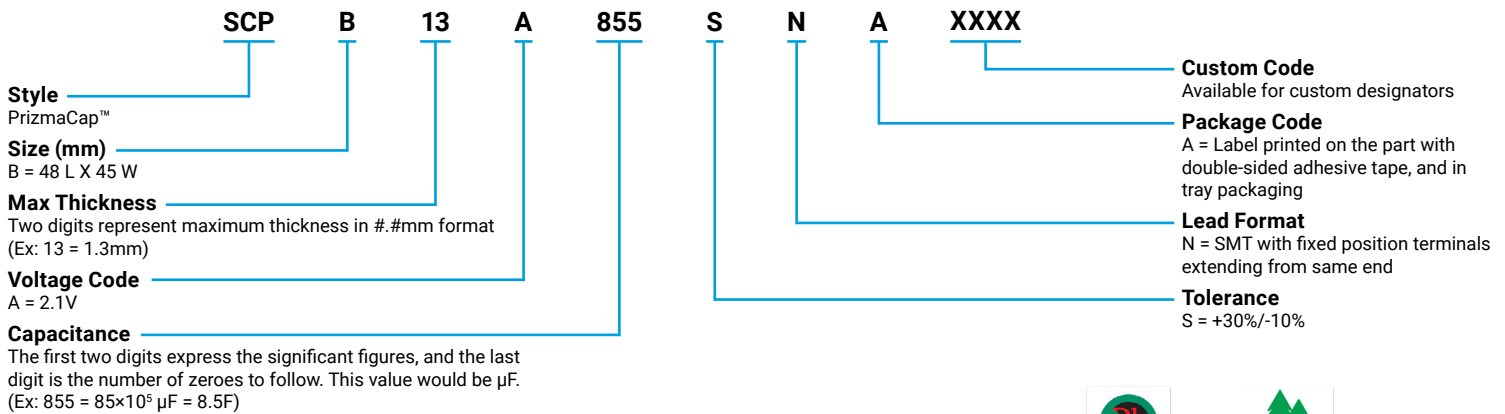

QUALITY INSPECTION

Parts are tested for life cycle, high temperature load life, temperature characteristics, vibration resistance, and humidity characteristics. See page 2 for more information.

TERMINATION

These supercapacitors are compatible with hand soldering as recommended on page 4.

OPERATING TEMPERATURE

-55°C to +65°C @ 2.1V

-55°C to +90°C @ 1.1V



For RoHS compliant products, please select correct termination style.

RATINGS & PART NUMBER REFERENCE

KYOCERA AVX Part Number	Length (mm)	Width (mm)	Max Thickness (mm)	Rated Capacitance (F)	Capacitance Tolerance	Rated Voltage (V)	Rated Temp. (°C)	DCL Max @ 72 Hrs (µA)	ESR Max @ 1 kHz (mΩ)	ESR Max @ DC (mΩ)	Peak Current (A)	Power Density (W/kg)	Max Energy (Wh)	Energy Density (Wh/kg)
SCPB08A355SNA	48	45	0.8	3.5	+30%/-10%	2.1/1.1*	65/90*	50	110	200	2.16	1413	0.0021	1.14
SCPB13A855SNA	48	45	1.3	8.5	+30%/-10%	2.1/1.1*	65/90*	80	50	80	5.31	2380	0.0052	1.87
SCPB20A156SNA	48	45	2.0	15	+30%/-10%	2.1/1.1*	65/90*	110	30	55	8.63	2582	0.0092	2.43

*with appropriate voltage derating operating temperature can be extended to 90°C

QUALIFICATION TEST SUMMARY

Test	Test Method	Parameter	Limits
Life Cycle	Capacitors are cycled between rated voltage and half-rated voltage under constant current at +25°C for 500,000 cycles	Capacitance Change ESR Appearance	≤30% of spec value ≤200% of spec value No remarkable defects
High Temperature Load Life	Temperature: +65°C Voltage: Rated Voltage Test Duration: 2,000 hours	Capacitance Change ESR Appearance	≤30% of spec value ≤200% of spec value No remarkable defects
Storage Temperature Characteristics	Storage Duration: 1 year No Load Temperature: +25°C	Capacitance Change ESR Appearance	≤30% of spec value ≤200% of spec value No remarkable defects
Vibration Resistance	Amplitude: 1.5mm Frequency: 10 ~ 55Hz Direction: X, Y, Z for 2 hours each	Capacitance Change ESR Appearance	≤30% of spec value ≤200% of spec value No remarkable defects
Humidity	Voltage: Rated Voltage RH: 90% Temperature: +60°C Test Duration: 1,000 hours	Capacitance Change ESR Appearance	≤30% of spec value ≤200% of spec value No remarkable defects

ELECTRICAL PROPERTIES VS. TEMPERATURE

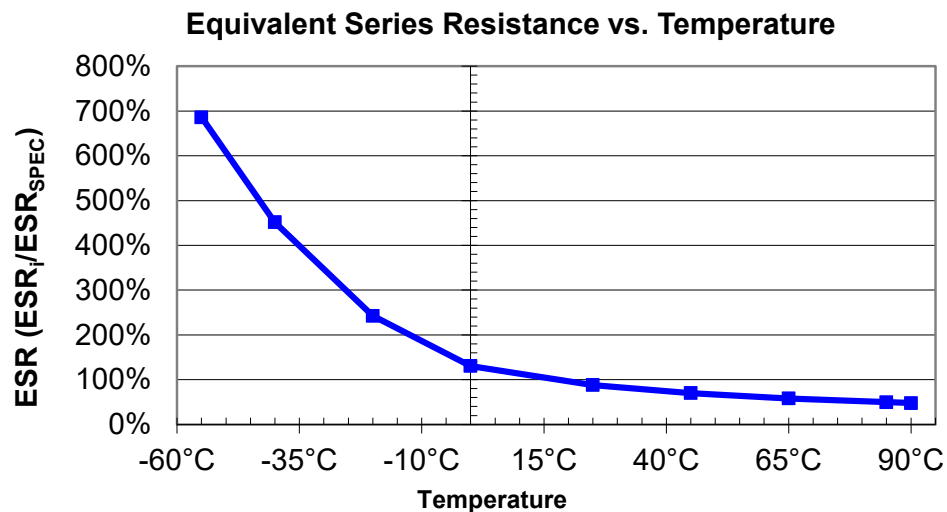
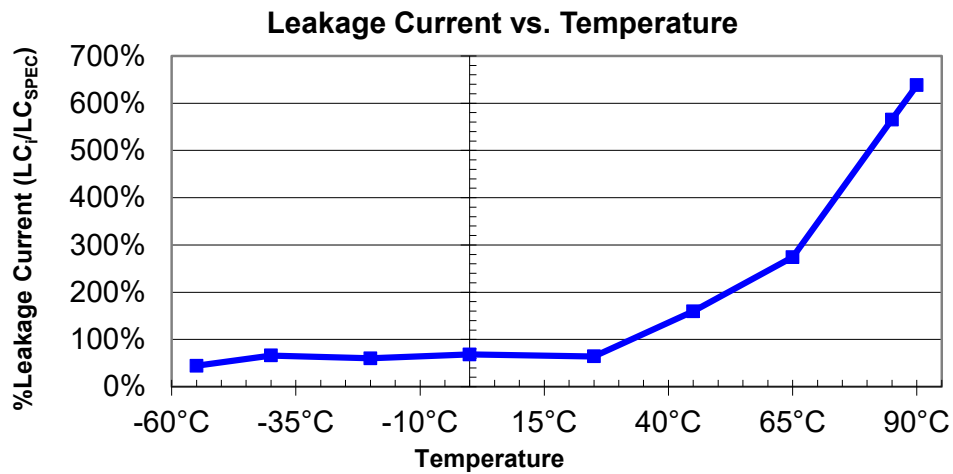
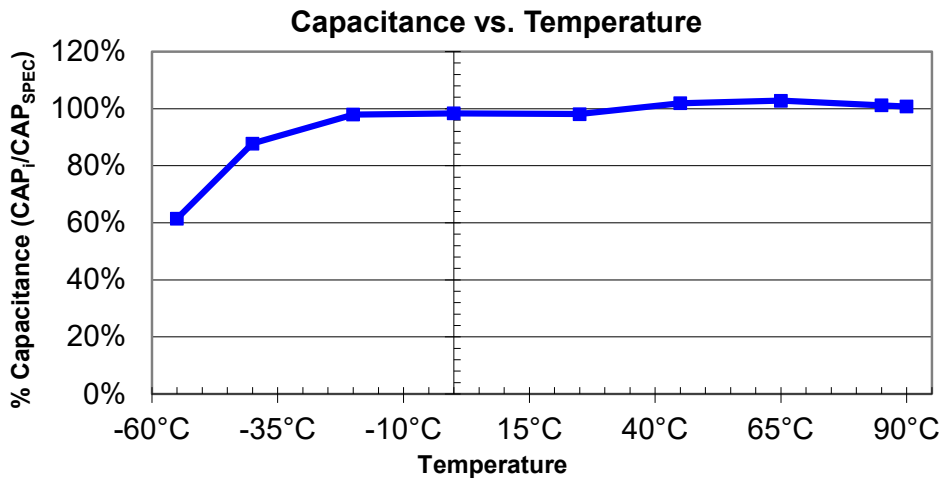

MECHANICAL SPECIFICATIONS

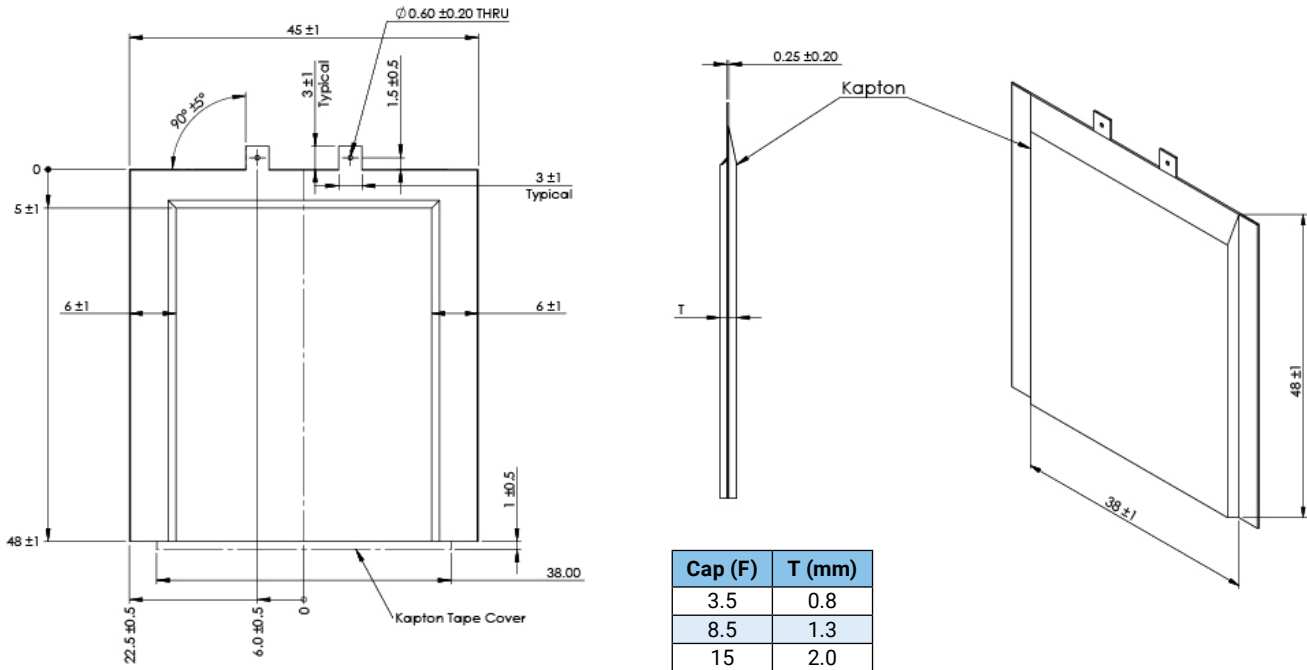

Note: When the supercapacitor is used under stressed conditions, it is expected to see some expansion of the supercapacitor. Expansion of the supercapacitor will not affect lifetime or performance.

SOLDERING RECOMMENDATIONS

PrizmaCap products can be mounted on PCBs either by hand soldering or use of a solder iron robot which selectively heats only the capacitor terminals. IR reflow or wave soldering may not be used. The soldering iron must never come in contact with the body of the capacitor. Temperatures and times above those recommended can cause damage to the body of the capacitor and potentially damaging the electrical properties.

HAND SOLDERING

Keep some distance between the supercapacitor body and the tip of the soldering iron; contact between supercapacitor body and soldering iron will cause extensive damage to the supercapacitor. It is recommended that the soldering iron temperature should be less than 350°C, and contact time should be limited to no more than 4 seconds. Too much exposure to terminal heat during soldering can cause heat to transfer to the body of the supercapacitor, potentially damaging the supercapacitor.

Equipment:	Temperature controlled 100W general purpose soldering iron
Lead Containing Solder	
Solder Type:	Sn63/Pb37 (MP~183°C)
Temperature:	260°C (+50°C / - 50°C)
Time:	2 seconds to 5 seconds maximum
Lead Free Solder	
Solder Type:	Sn96.5/Ag3.5 or Sn96.5/Ag3/Cu0.5 or Sn95.5/Ag3.8/Cu0.7 (MP~220°C)
Temperature:	300°C (+50°C / - 50°C)
Time:	2 seconds to 5 seconds maximum

Note: Use shortest possible time to minimize heat transfer into the PrizmaCap.

SCP Series

PrizmaCap™

TEST METHODS

IEC CAPACITANCE TEST METHOD 62391-1

Capacitance is measured using a sourcemeter (Keithley 2400 for example). Alternately, a power supply and load may be used, but accuracy can be compromised.

Procedure:

- Charge capacitor to Rated Voltage at room temperature
- Continue charging at Constant Voltage for 30 minutes
- Remove the charge and allow 10 seconds for the capacitor to stabilize
- Discharge cells with a constant current, I (mA) determined by $4 \times CR \times VR$
- At 80%VR record (V1, t1) and at 40% VR record (V2, t2)

$$I = 4 \times CR \times VR \text{ (mA)}$$

V1 Start Voltage, 80% VR (Volts)

V2 End Voltage, 40% VR (Volts)

t1 Start Time (sec.)

t2 End Time (sec.)

Calculate Capacitance in Farads (using I in Amps.).

$$\text{Capacitance} - C = I \times (t1 - t2) / (V1 - V2) \text{ (Farads)}$$

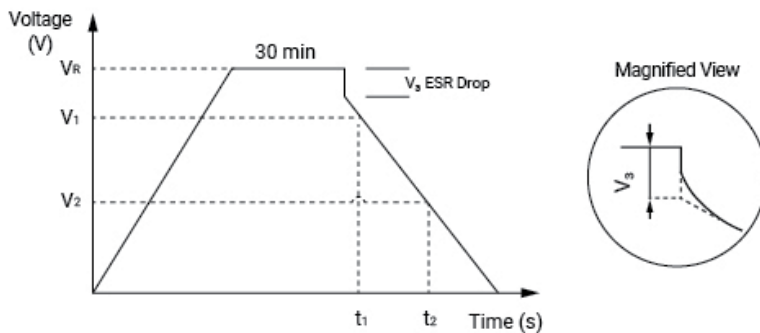

Figure 1; Constant current discharge method for capacitance, and V3 voltage drop for DCESR.

AC ESR MEASUREMENT

ACESR is measured using an LCR Meter and a Kelvin connection

Procedure:

- Measure at frequency of 1000 Hz
- Signal level of 1,000mV
- Record series resistance, Rs (Ohms)

DC ESR MEASUREMENT

DCESR can be calculated from figure 1, where $RDC = V3/I$

Procedure:

- To determine V3, use a straight-line approximation of the two voltage versus time curves and determine the intersection of the lines (shown in the magnified figure).

Accuracy can be increased by using a high data acquisition rate.

Alternately, DCESR is measured using an LCR Meter and a Kelvin connection.

Procedure:

- Measure at frequency of 20 Hz
- Signal level of 1,000mV
- Record DC series resistance, RDC (Ohms)

TEST METHODS

MAXIMUM OPERATING CURRENT

- This is the maximum current when capacitor temperature rise of the capacitor during its operation is less than 15°C

MAXIMUM PEAK CURRENT

- This is the maximum current in less than 1 sec

WATT DENSITY

- Watt Density = $(0.12 \cdot V^2 / RDC) / \text{mass}$

ENERGY DENSITY

- Energy density = $(\frac{1}{2} CV^2) / (3600 \cdot \text{mass})$

POLARITY / REVERSE VOLTAGE

For product consistency and optimum performance, it is recommended that the capacitor be connected with polarity indicated. Reversing polarity could result in permanent damage to the circuit including much higher leakage current for a short duration of time and the life time of the supercapacitors will be reduced.

LIFE TIME AND TEMPERATURE PERFORMANCE

The life of a supercapacitor is impacted by a combination of operating voltage and the operating temperature according to the following Time to Failure equation:

$$t \propto V^n \times e^{(-Q/KT)}$$

where V is the operating voltage, Q is the activation energy in electron volts (eV), k is the Boltzmann constant in eV, and T is the operating temperature in Kelvin (K). Typical values for the voltage exponent, n, is between 2.5-3.5, and Q is between 1.0-1.2 eV in the normal operating temperature range of -40° to 65°C.

The industry standard for supercapacitor end of life is when the equivalent series resistance, ESR, increases to 200% of the specified value and the capacitance drops by 30% from specified value. Typically a supercapacitor shows an initial “jump” in the ESR value and then levels off. If the supercapacitors are exposed to excessive temperatures the ESR will show a continuous degradation (increase). In the extreme case, if the temperature or voltage are substantially higher than the rated specifications, this could result in the part venting and the product showing a faster degradation of capacitance and ESR, which may be many times the specified value.

LIFE TIME AND TEMPERATURE PERFORMANCE

Expected Lifetime at Various Voltages
PrizmaCap Series 2.1V Rated

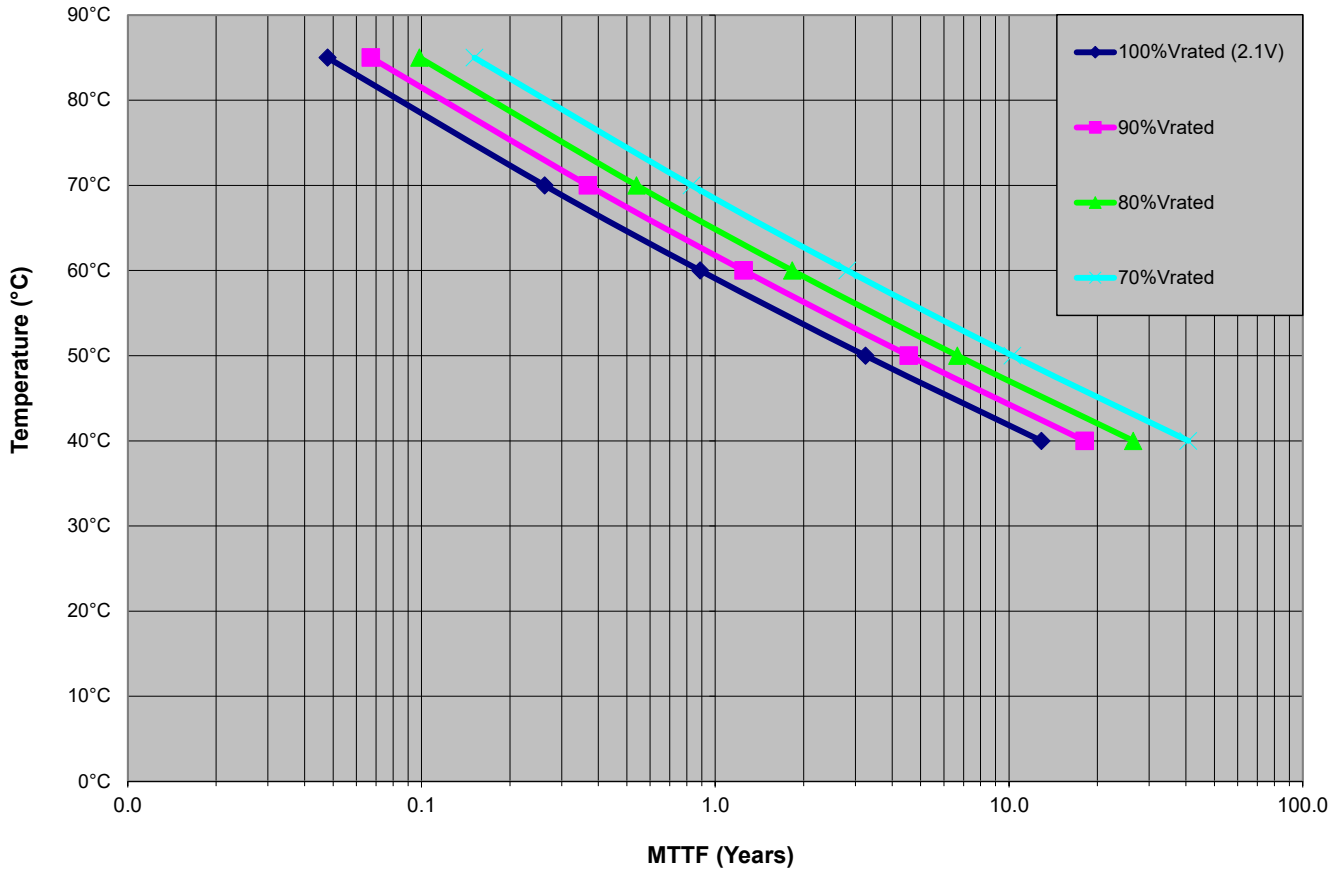

SAFETY RECOMMENDATIONS

WARNINGS

- To Avoid Short Circuit, after usage or test, Super Capacitor voltage needs to discharge to $\leq 0.1V$
- Do not Apply Overvoltage, Reverse Charge, Burn or Heat Higher than 120°C, heat seal may break open
- Do not Press, Damage or disassemble the Super Capacitor, packaging could heat to high temperature causing Burns
- If you observe Overheating or Burning Smell from the capacitor disconnect Power immediately, and do not touch

EMERGENCY APPLICATIONS

- If Housing is Leaking:
 - Skin Contact: Use soap and water thoroughly to wash the area of the skin
 - Eye Contact: Flush with flowing water or saline, and immediately seek medical treatment
 - Ingestion: Immediately wash with water and seek medical treatment

TRANSPORTATION

Not subjected to US DOT or IATA regulations

UN3499, <10Wh, Non-Hazardous Goods

International shipping description – “Electronic Products – Capacitor”

REGULATORY

- RoHS Compliant
- REACH Compliant

STORAGE

Capacitors may be stored within the temperature range of -40°C to +70°C with humidity < 60%. Lower storage temperature is preferred as it extends the shelf life of the capacitor. Product over one year and within two years of the date code, we recommend recharging the product at the beginning of use for at least 24 hours.

Optimum storage conditions are as follows:

- 25°C and RH \leq 60% without voltage applied
- Not in direct sunlight
- Not in direct contact with water, salt oil or other chemicals
- Not in direct contact with corrosive materials, acids, alkalis, or toxic gases
- Not in dusty environments
- Not in environments with shock and vibration conditions

Licensed by CAP-XX