

ATEVK525 Mass Storage Board for AVR

Hardware User Guide





Section 1	
Introduction	1-3
1.1 Overview	1-3
1.2 ATEVK525 AVR Mass Storage Board Features	1-4

Section 2	
Using the ATEVK525	2-5
2.1 Getting started	2-5
2.2 NAND Flash	2-7
2.3 SD/MMC Card	2-11
2.4 LEDs	2-12
2.5 Test Points	2-12
2.6 Configuration Pads	2-13
2.7 Solder Pads	2-14

Section 3	
Software Implementation	3-15
3.1 Software packages	3-15
3.2 Performances	3-17
3.3 Driver limitations	3-18
3.4 Usage Notes	3-19
3.5 Handling another NAND Flash device	3-19

Section 4	
Troubleshooting Guide	4-21

Section 5	
Technical Specifications	5-23

Section 6	
Technical Support	6-24

Section 7	
Complete Schematics	7-25



Section 1

Introduction

Congratulations on acquiring the AVR® ATEVK525. This kit is an extension board designed to enhance and demonstrate Mass Storage features in addition to the existing development boards supporting the AT90USBxxx family.

1.1 Overview

This document describes the ATEVK525 dedicated to the AT90USBxxx <Generic Product Name> microcontroller. This board is designed to allow an easy evaluation of USB Mass Storage using demonstration software.

The ATEVK525 board has been designed to be plugged into the Atmel STK525 Starter Kit Board in order to add Mass Storage capability to an existing development board, and to combine them with other features (USB, RS232, Microphone..., but also all AVR development tools), reducing the extension board complexity and cost.

This user guide acts as a general getting started guide as well as a complete technical reference for advanced users.

Figure 1-1 . ATEVK525

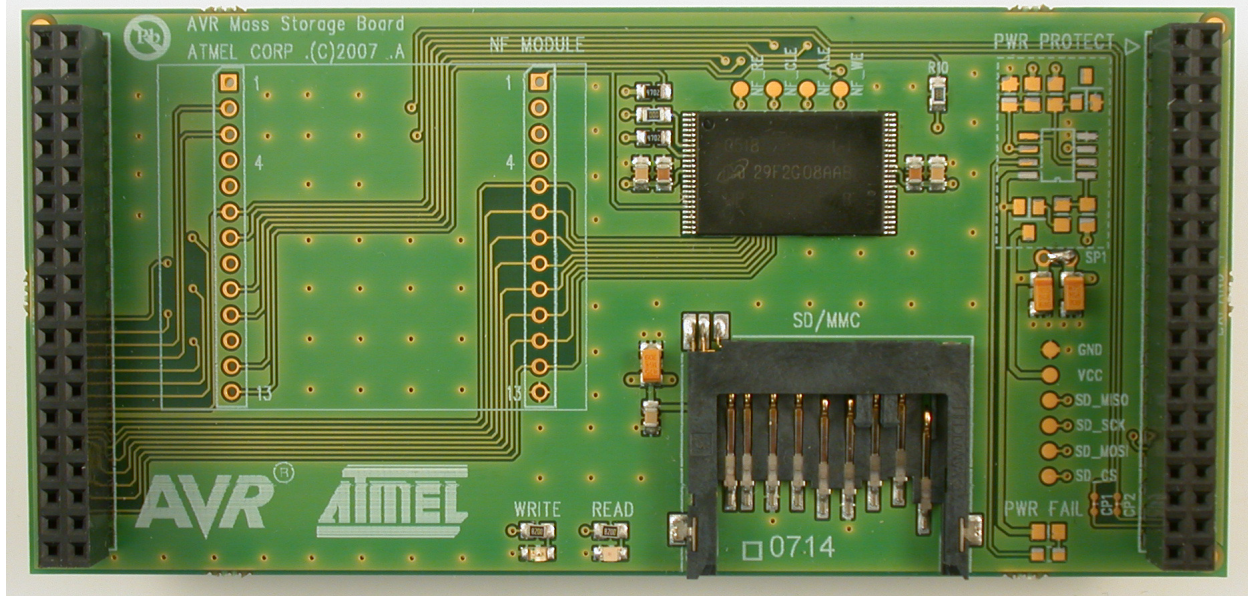

1.2 ATEVK525 AVR Mass Storage Board Features

The ATEVK525 provides the following features:

- NAND Flash chip soldered (Micron MT29F2G08AACWP, 256 MBytes)
- Reserved location additional NAND Flash chips module plug-in
- Receptacle for SD and MMC memory cards
- LED signalling for Read/Write operations
- Power supply :
 - 3.3V regulated from motherboard
 - Additional overvoltage protection circuitry (optional) with failure indicator
- Numerous access points for debug



Section 2

Using the ATEVK525

This chapter describes the board and all its features.

2.1 Getting started

2.1.1 Plugging the board

The ATEVK525 is an extension board that must be plugged on another microcontroller hosting board, like STK525 (AT90USBxxx support), that provides supply voltage.

Figure 2-1 . Connecting the ATEVK525 under the STK525

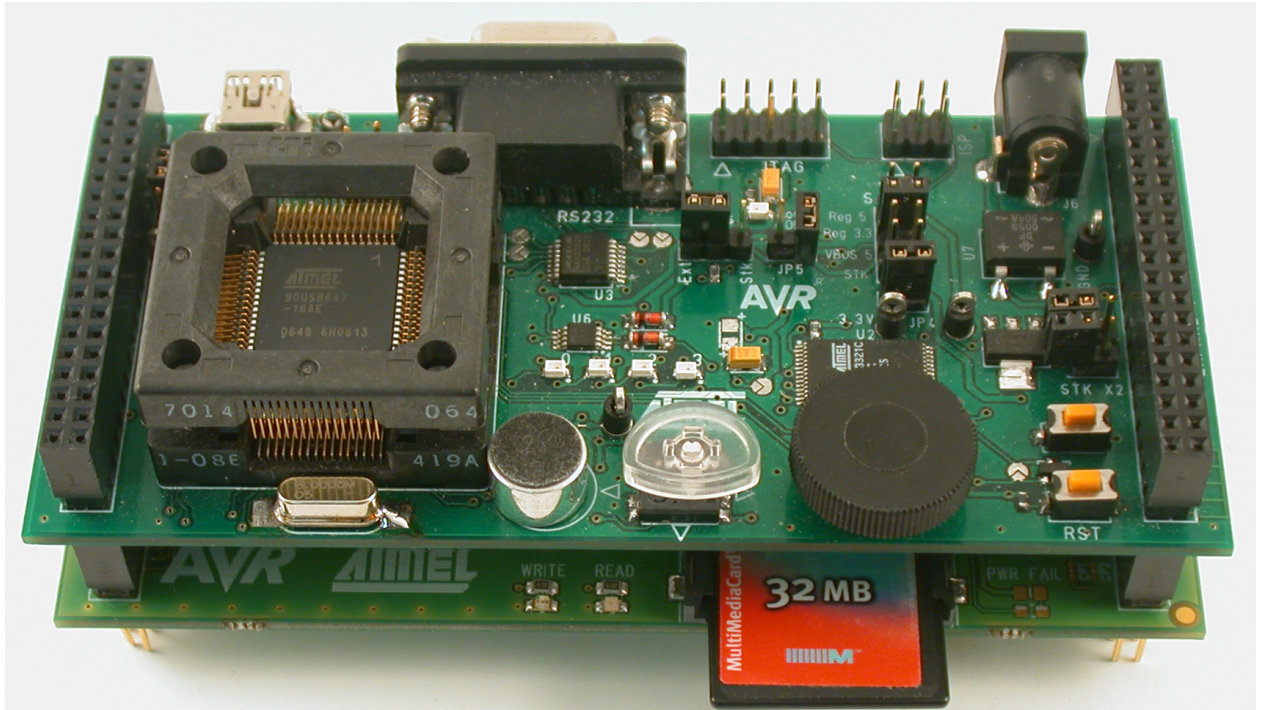

Note: The ATEVK525 can also be plugged onto the STK525, but in this configuration, the user must take care to avoid contact between the board and either the JTAG plug or the microcontroller ZIF socket.

2.1.2 Power supply

The ATEVK525 must be powered with a voltage between 2.8 and 3.5V.

Before connecting or powering the boards, you must ensure the power supply configuration on the motherboard.

The voltage must be set to 3.3V (microcontroller I/O levels), and this voltage must be present on the VTG pins of the EXPAND connectors.

On the STK525, the configuration must be:

- **JP4** closed (ties 3.3V to VTG pins)
- **VCC SOURCE** set to REG 3.3 mode (powers microcontroller I/O at 3.3V)

Figure 2-2 . Configuration to set on STK525

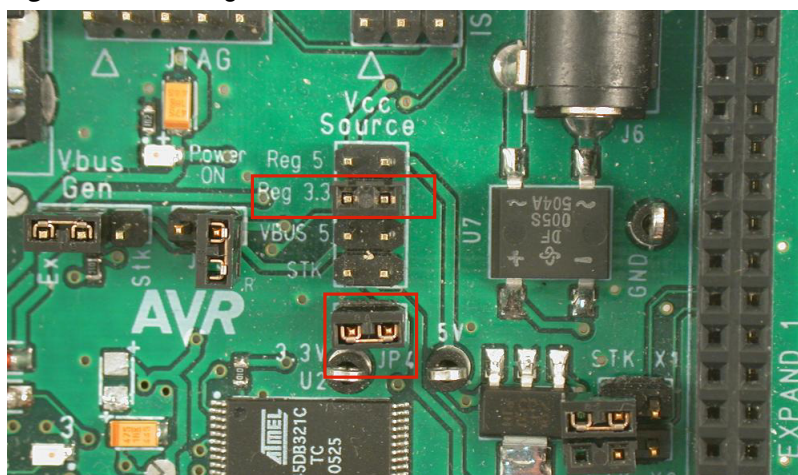

NAND Flash (MT29F2G08AACWP) current consumption is 1mA maximum in idle state, and can reach 30mA (15mA typ.) during access operations (read/write/erase). For the SD/MMC card consumption, please refer to your SD/MMC card datasheet.

2.1.3 Protection circuitry

The ATEVK525 includes an optional power supply protection circuit that prevents on-board resources from being damaged.

Figure 2-3 . Power protection circuit location

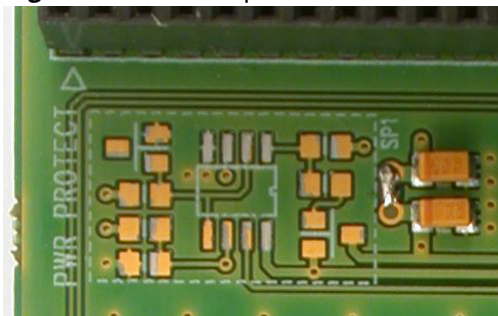

This supplement, if mounted, protects the storage devices from voltage above 3.5V. In case of overvoltage detection, the power positive line of the extension board is not connected to devices, and the LED “PWR_FAIL” is lit.

If the supplement is not mounted or needs to be disabled, the solder pad SP1 must be soldered to connect power supply of the on-board resources (see photo above).

2.2 NAND Flash

2.2.1 Default device

The ATEVK525 comes with one NAND Flash chip soldered. At the time of writing, this chip is the Micron MT29F2G08AACWP that features:

- 2 GBits (256 MBytes) organized as:
 - 2048 blocks
 - block size : 64 pages
 - page size : 2112 bytes (2048 + 64 in spare zone)
- Page program time of 300μs, Block erase time of 2ms
- Copy-Back feature (enable cache transfers between blocks to speed up write operation; no memory zone / address limitation)

The memory access is managed by the External Memory Interface hardware peripheral of the AT90USBxxx microcontroller. Data and Address information share the same 8-bit wide bus connected to the lowest bits of Memory Interface (A7-A0), while the Control signals are connected to upper bits:

Table 2-1 . NAND Flash pin assignment

NAND Flash	Microcontroller	Function
I/O[7:0]	PORTA[7:0] (A7-A0)	Data and Address bus
CLE	PORTC0 (A8)	Command Latch Enable
ALE	PORTC1 (A9)	Data Latch Enable
RE#	PORTE1 (RD#)	Read enable
WE#	PORTE0 (WR#)	Write enable
CE#	PORTC2 (A10)	Chip select (active low) (with on-board pull-up)
R/B#	PORTC6	Ready / Busy# (pull-up must be enabled in micro)

Note: The '#' character indicates that the corresponding signal is active low.

2.2.2 Additional devices

NAND Flash Module Description If another memory device is required for development or evaluation purpose, it is still possible to install it on the ATEVK525 through an additional module as described below.

The board provides two SIP-13 receptacle footprints (2.54mm pitch). Users can solder a receptacle on the board and then insert a NAND Flash module described below, or directly solder the module.

Figure 2-4 . NAND Flash module example

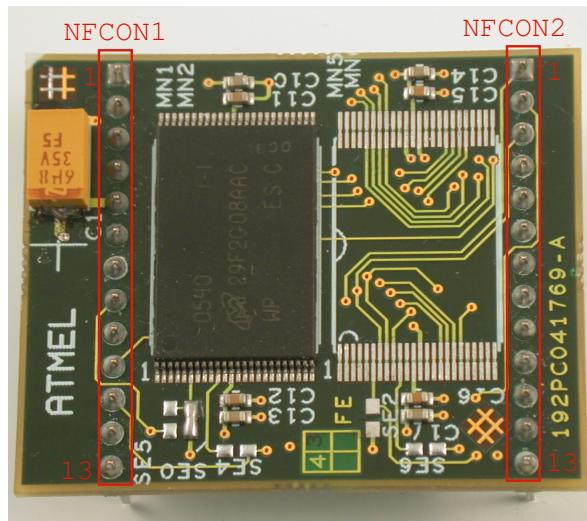

Table 2-2 . NAND Flash module pin-out description

NFCON1		NFCON2	
Pin #	Function	Pin #	Function
1	WP2#	1	WP3#
2	CE3#	2	R/B3#
3	CE2#	3	R/B2#

NFCON1		NFCON2	
Pin #	Function	Pin #	Function
4	WP0#	4	WP1#
5	VCC	5	D7
6	CLE	6	D6
7	ALE	7	D5
8	R/B1#	8	D4
9	CE0#	9	D3
10	R/B0#	10	D2
11	CE1#	11	D1
12	RE#	12	D0
13	WE#	13	GND

Refer to the CD-ROM documentation if you wish to create your own PCB board and mount devices on this board (BOM and components placement).

Each module can receive up to four different devices, according to the following placement :

Table 2-3 . NAND Flash devices placement

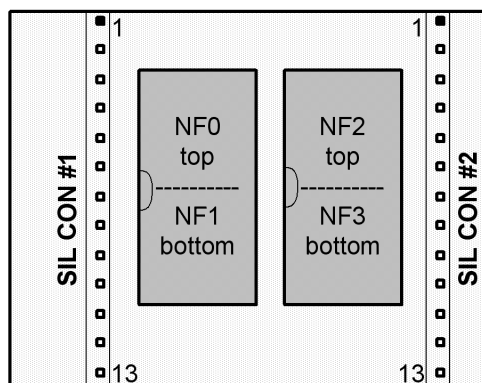

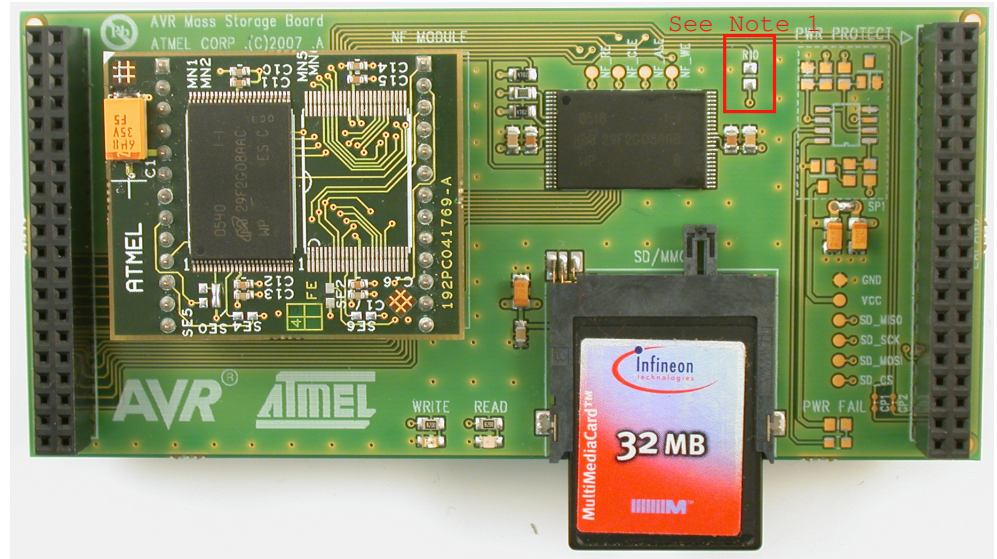
NF Module Installation **Figure 2-5** . NAND Flash module on the ATEVK525, plus MMC card

When using the NAND Flash module, the following pin assignments do not change : Data/Address bus, CLE, ALE, RE#, WE#, WP# (Write Protect feature drives all the chips at the same time). Other signal assignments are grouped in the following table.

Table 2-4 . NAND Flash module pin assignment

NAND Flash	Microcontroller	Function
CE0#	PORTC2 (A10)	Chip select for chip 0 (active low, on-board pull-up)
CE1#	PORTC3 (A11)	Chip select for chip 1 (active low, on-board pull-up)
CE2#	PORTC4 (A12)	Chip select for chip 2 (active low, on-board pull-up)
CE3#	PORTC5 (A13)	Chip select for chip 3 (active low, on-board pull-up)
R/B0#	PORTC6	Ready / Busy# for chip 0 (pull-up to enable in micro)
R/B1#	PORTC7	Ready / Busy# for chip 1 (pull-up to enable in micro)
R/B2#	PORTD0	Ready / Busy# for chip 2 (pull-up to enable in micro)
R/B3#	PORTD1	Ready / Busy# for chip 3 (pull-up to enable in micro)

- Note:**
1. When using the additional module, the resistor R10 must be unsoldered, else the CE# lines of the NAND Flash soldered and the NAND Flash #0 of the module will be connected together (not applicable if NF #0 is not mounted on the module)
 2. When using the additional module, check that the configuration pads that enable CTS/RTS lines on STK525 are not soldered, because these signals are also connected to the R/B#2 & 3. But if CTS/RTS lines are required, you cannot use the R/B#2 & 3 signals, so disable the configuration pads CP1 & CP2 of the ATEVK525.

2.3 SD/MMC Card

The ATEVK525 includes a receptacle compatible with SD and MMC memory cards.

Figure 2-6 . SD card pinout (contact view)

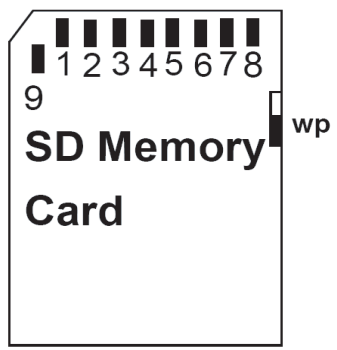

- Note:
1. The MMC card defined by specification v3.31 and earlier have only the pins #1 to #7
 2. The MMC card defined by specification v4.0 and later (MMC Plus, Extra..) has 13 pins (increasing parallel data bus width)

Regardless of their differences, all SD/MMC cards have the following common points :

- **SPI mode:** through a standard SPI bus, that method reduces the transfert speed, but is easy to implement. The alternate access method is a parallel mode
- **Command set:** cards have numerous commands that are common enough to completely control the memory. Only the initialization process is different (but a standard procedure automatically enables card identification and initialization). Be aware of the card specification version (information contained in the CSD structure of the card) before using advanced features (password protect, etc.).

Table 2-5 . SD/MMC card pin assignment in SPI mode

Pin #	SD/MMC Card	Function in SPI Mode	AVR MCU
1	CS#	Chip Select (active low)	PORTB,0
2	DI	SPI Master Out Slave In	PORTB,2 (MOSI)
3	VSS	Ground	Gnd
4	VDD	Supply Voltage	Vcc
5	SCK	SPI Clock	PORTB,1 (SCK)
6	VSS	Ground	Gnd
7	DO	SPI Master In Slave Out	PORTB,3 (MISO)

2.4 LEDs

Three LEDs are on the board:

- **PWR_FAIL**: orange LED that signals an overvoltage condition if the protection circuit is mounted. This LED is optional.
- **WRITE**: red LED connected to PORTD7 of micro (also LED1 on STK525), that may be driven by software when initiating a SCSI Write command
- **READ**: green LED connected to PORTD5 of micro (also LED3 on STK525), that may be driven by software when initiating a SCSI Read command

Figure 2-7 . On-board SCSI signalling LEDs

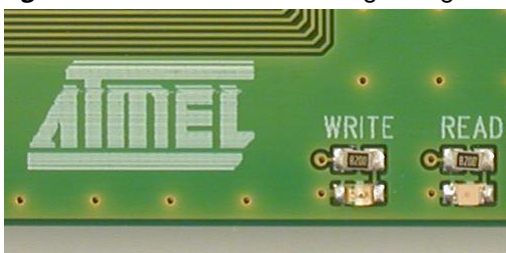

2.5 Test Points

Several test points are included on the board to facilitate debug during development. All the test points are circular pads with a silk-screen printing that indicates the corresponding signal:

- VCC: power supply voltage (should be 3.3V), taken after the power protection circuit
- GND: power supply ground

- SD_MISO: SD/MMC card MISO signal (card output)
- SD_MOSI: SD/MMC card MOSI signal (card input)
- SD_SCK: SD/MMC clock signal
- SD_CS: SD/MMC chip select signal (active low)

- NF_CLE: NAND Flash CLE signal
- NF_ALE: NAND Flash ALE signal
- NF_RE: NAND Flash RE# signal
- NF_WE: NAND Flash WE# signal

2.6 Configuration Pads

Configuration pads are used to disconnect/connect on-board peripherals or elements. Their default configuration is: **connect**.

2.6.1 Configuration Pads Listing

Table 2-6. Configuration Pads

Config. Pads Reference	Related Signals	Function
CP1	R/nB2	Connect Ready/notBusy signal from NF#2 (third NF of the optionnal module) to STK525
CP2	R/nB3	Connect Ready/notBusy signal from NF#3 (fourth NF of the optionnal module) to STK525

Note: See section 2.2.2 Additional devices for more details.

2.6.2 Configuration Pads - Disconnection

Figure 1. Configuration Pad - Disconnection

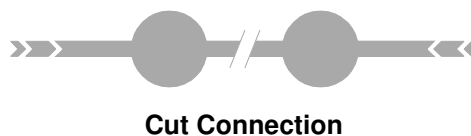

2.6.3 Configuration Pads - Connection

Figure 2. Configuration Pad - Re-connection



2.7 Solder Pads

Solder pads are used to disconnect/connect on-board peripherals or elements. Their default configuration is: **disconnect**. User may solder the pad to enable it.

2.7.1 Solder Pads Listing

Table 2-7. Solder Pads

Solder. Pads Reference	Related Signals	Function
SP1	VCC	This solder pad allows power protection circuit bypassing. If this optional circuit is not mounted, this solder pad must be soldered.



Section 3

Software Implementation

This section contains information about the software package, its performance and known limitations.

3.1 Software packages

When you have connected the boards together and correctly checked their configuration, you are invited to run one of the available demonstration packages:

- **USB Device External Multi Disk Drives.** The board enumerates as a USB composite Mass Storage device, and combines three external removable mass storage media:
 - MMC/SD memory card reader (depends on card used)
 - NAND Flash 256MB (default, otherwise depends on chip used) disk
 - DataFlash 8 MB disk

This package can be found on the CD-ROM provided with the kit.

- **USB Dual-Role Host / Device with FAT support and Shell**
 1. In Device mode (B-connector plugged), the package is identical to the first package, that enumerates three hardware storage volumes through the USB.
 2. In Host mode (A-connector plugged), the application allows connecting one USB mass storage device.
 3. In both modes, the STK525 can be connected to a serial terminal (using HyperTerminal on PC side for example), where the user can access a simple command line interpreter (ushell) to perform file system access (FAT management included in software):
 - 57600 bps
 - 8 bits data, 1 bit stop, no parity
 - no flow control
 4. Navigation in the file system (on-board memories or USB Mass Storage device connected to the USB Host interface) supports following commands:
 - **a:, b:** ... (goto selected drive)

- **cd** *dirname* (change to specified directory)
- **ls** (list current directory content)
- **touch** *filename* (create an empty file)
- **append** *filename* (add text to the specified file)
- **mark** (bookmark current directory)
- **cp** *filename* (copy filename to bookmark)
- **rm** *filename* (erase file or empty directory)
- **format** *drivename* (format the drive)
- **deltree** *drivename* (delete recursively a directory)
- **cat** *filename* (display file content)
- **cd..** (come back to previous directory)
- **mount** *disk* (mount drive a, b...)
- **mkdir** *filename* (create a directory)
- **disk** (get number of drives and memory type associated)
- **goto** (goto bookmark)
- **df** (get free space information)
- **rm*** (delete all files in the directory)
- **lsusb** (get information about the connected device, in host mode only)
- **suspend** (suspend USB bus activity)
- **resume** (resume USB bus activity)
- **reboot** (reset the application)

This package is also included on the CD-ROM as a password protected archive. Please refer to the CD-ROM documentation to know the procedure to follow to register and access the source code.

Note: At first board start-up, the on-board memory chip need to be formatted by the Host operating system.

3.2 Performances

3.2.1 Benchmark

Table 3-1 . Memory speed benchmark (8MHz clocked microcontroller ⁽¹⁾)

Memory		Speed (KBytes/sec)	
		Read	Write
DataFlash	AT45DB321 (page 512B)	200	35
	AT45DB642 (page 1024B)	200	55
MMC/SD	SD 1GB 80x	235	235
	SD 256MB	215	155
	MMC Plus 2GB Premium	235	170
	MMC 32MB (old revision)	215	50
NAND Flash	M29F2G008AAC (page 2KB, copyback)	1095	860
	K9K2G08UOM (page 2KB, copyback disabled ⁽²⁾)	1005	660
	HYF31DS512805 (page 512B, no copyback)	1110	590

- Note:
1. The AVR micro controller cannot be clocked at 16MHz since this configuration requires a 4.5V minimum power supply whereas NAND Flash or SD/MMC devices do not withstand such a voltage level on I/Os. However, DataFlash are 5V-tolerant, and speed measurements have been done independently of this evaluation board: for 45DB321, write speed is 40KB/sec and read speed is 300KB/sec. For 45DB642, write speed is 80KB/sec and read speed is 300KB/sec.
 2. In the K9K2G08UOM device, the COPYBACK instruction cannot be used in all the memory plane, since it is efficient only between size-limited zones. This problem concern several other memories devices.

3.2.2 Direct limitations

- The limitations on reading operations are:
 - Dataflash: SPI bus frequency, internal read access speed
 - SD/MMC: SPI bus frequency, internal read access speed
 - NAND Flash: USB maximum data rate
- The limitations on writing operations are:
 - Dataflash: internal write access speed, page write duration & size, SPI bus frequency
 - SD/MMC: internal write access speed and duration, SPI bus frequency
 - NAND Flash: memory internal writing structure (COPYBACK support or not, page write and block erase duration, page size), USB maximum data rate

3.3 Driver limitations

3.3.1 DataFlash

This is a mature driver that will not need to be substantially modified. This driver has been tested with the AT45DB321 and AT45DB642. If you look at the code, you will notice a special memory page management if 2 or 4 Dataflash devices are used on the same bus.

In the case of 2 or 4 DataFlash sharing the same SPI bus (this is not the case here), the driver can interlace the memory pages to enhance write speed. For contiguous sector write operations, the driver switches to the next memory as soon as a page programming operation has been started on the current memory. In this way, two or four contiguous pages (2 KBytes or 512 Bytes according to the memory reference) are allocated on different memories.

3.3.2 SD/MMC

Like the DataFlash driver, no substantial modifications should be required. The SD and MMC specification should remain backward compatible with the old releases, so that this driver only exploits the basic functionalities of the specifications, in order to be compatible even with old memories.

However, several enhancements can be done to enhance operational timing (write, read), particularly using multiple block read/write instructions in a “software way”, or by implementing SD Bus operation, in a more “hardware way”.

3.3.3 NAND Flash

The NAND Flash technology and the consumer request for continually faster and larger devices conduce to numerous enhancements of memories structure, and thus memory management drivers.

Limitations:

- The COPYBACK feature is not address-dependent in the current driver version. This means that the instruction is used by the driver to copy a page into another without regards to the page addresses. But, due to higher capacities, more and more new devices support COPYBACK on limited zones only: for example a COPYBACK operation may only be possible between two blocks that share the same half-device plane, or between odd or even blocks numbers. This may be due to internal structure of memory (two memory planes, one over the other for example). So the COPYBACK feature must be disabled in the driver for devices that impose restrictions about it.
- ECC (Error Correction Code) is not implemented in the driver. A basic ECC can detect 2-bit error and correct 1-bit error per 256 or 512 bytes. However, such a feature can still be added to the driver. The ECC implementation may result in a compromise between data reliability and speed performance.
- Another feature that should be implemented next is the Recovery option. This option prevents user halts or disconnections during write operations from destroying the memory File System structure, by recovering the data lost in the last write

operations.

- Also, the support of more than one memory chip (facilitating memories interlacing) is not yet integrated in the driver. That also concerns memories that are made of several memory dies stacked (generally memories of 4GBits and more).

Supported device list : supported devices are listed in the NH.F file of the driver.

3.4 Usage Notes

Please read these notes carefully:

- Once your file modifications (create, copy, delete) have been made on the Mass Storage device, always eject the device properly. Under Windows O.S. you must click on the corresponding button (near the clock) in the Windows task bar, to “Safely remove hardware”. This will force the O.S. to flush all the write operations that are needed to end the Mass Storage device access. If such an operation is not made, it is possible that the last write operations are not completed, and since these operation often concern the File Allocation Table, the device integrity can be damaged.
- When using the NAND Flash media as a storage device, when all the operations seem to be completed (Windows safe eject, etc.), all the data to be written is inside the NAND Flash driver. But there is a limitation that must be taken in account. When a page (512B or 2BK) has to be updated in the memory, all the corresponding blocks (each block contains 64 pages for example) is copied to a new free block, and the required page is modified during the copy. To end this operation of block translation, all the pages up to the modified one are programmed. But to precede an optional contiguous write operation, the pages that end the block (the block tail) are not yet programmed. They will be programmed if the next operation is a Read, or a Write to a page that is not contained in the same block. So, before powering down the Mass Storage board, the software cannot predict if the last BLOCK COPY TAIL operation has been done. Thus the user must call the “void nf_usb_stop(void)” function from “nf_mngt.c” file. In the current package, this function is automatically called when USB Suspend or Disconnect condition is detected (that does not work in Bus powered application).

3.5 Handling another NAND Flash device

If a new NAND Flash device must be supported, the user must use the NF MODULE location on the board to plug a NAND Flash board on which the required device is soldered.

Once the hardware modifications are done (R10 unsoldered), there are software modifications to be done according to the NAND Flash device structure

- “NF.H” file
 - if your device is already included in the supported devices list, you have nothing to do in this file.
 - if your device is not included in the supported devices list, you must add it, using the same description structure that other devices.
- “CONF_NF.H” :

- if you want to use only one other memory reference, you must define the memory name. For example, the board comes with the default configuration
#define NF_TYPE_MT29F2G08AACWP
- if you want to use different modules with different memory references, without modifying the driver, you must enable to TRUE either **NF_AUTO_DETECT_2KB** or **NF_AUTO_DETECT_512B**, according to the page size of the memory.



Section 4

Troubleshooting Guide

Please refer to this guide before sending a request to AVR Technical Support. Main problems should be solved here. This guide assumes that the board driver file provided by Atmel is used.

Figure 4-1 . Troubleshooting Guide

Problem	Reason or Condition	Problem / Solution
ATEVK525 does not work	Bad power supply	Check the power supply source level (3.3V) on VCC testpoint.
	Board not correctly mounted	Check that the board has been mounted in the correct sense.
		If the board is over the STK525, check that the ZIF socket is not perturbed by it. Same thing for the JTAG plug if used.
	Protection circuit problem	If the PWR_FAIL LED is lighting ON whereas the voltage you measure on VCC is correct, bypass the protection circuitry (solder SP1).
NAND Flash device (onboard chip only) does not work	Additional module is mounted.	The onboard memory chip cannot be accessed while the optional NAND Flash module is mounted since two memories will share their chip select signal.
	Chip select resistor not mounted	Check that the R10 resistor is correctly mounted, else the chip will never be selected.
NAND Flash device (additional module) does not work	Chip select resistor still mounted	Check that the R10 resistor is not mounted (else both onboard chip and module chip are selected at the same time)
	Module not correctly mounted	Check if the module is correctly mounted. Use preferentially a socket.

Problem	Reason or Condition	Problem / Solution
SD/MMC does not work	Bad physical contact	Check the insertion direction. It can sound stupid, but that can happen to anybody...
	Memory failure	Check that the connector is not too old. Memories are not immortal...Check the memory card with another memory reader.



Section 5

Technical Specifications

■ System Unit

- Physical Dimensions L=119 x W=56 x H=23 mm
- Weight 50 g

■ Operating Conditions

- Internal Voltage Supply 3.3V (+/-10%)
- External Voltage Supply 3.3V (+/-10%) (100mA)

■ Features

- NAND Flash device MT29F2G08AACWP
- MMC/SD receptacle
- Additional NAND Flash devices support
- Embedded signalling LEDs
- Optional power protection circuit



Section 6

Technical Support

For Technical support, please contact avr@atmel.com. When requesting technical support, please include the following information:

- Which target AVR device is used (complete part number)
- Target voltage and speed
- Clock source and fuse setting of the AVR
- Programming method (ISP, Parallel or specific Boot-Loader)
- Hardware revisions of the AVR tools, found on the PCB
- Version number of AVR Studio. This can be found in the AVR Studio help menu.
- PC operating system and version/build
- PC processor type and speed
- A detailed description of the problem



Section 7

Complete Schematics

On the next pages, the following documents of ATEVK525 are shown:

- Complete schematics,
- Assembly drawing,
- Bill of materials.
- Default configuration summary

Figure 7-1 . Schematics, 1 of 1

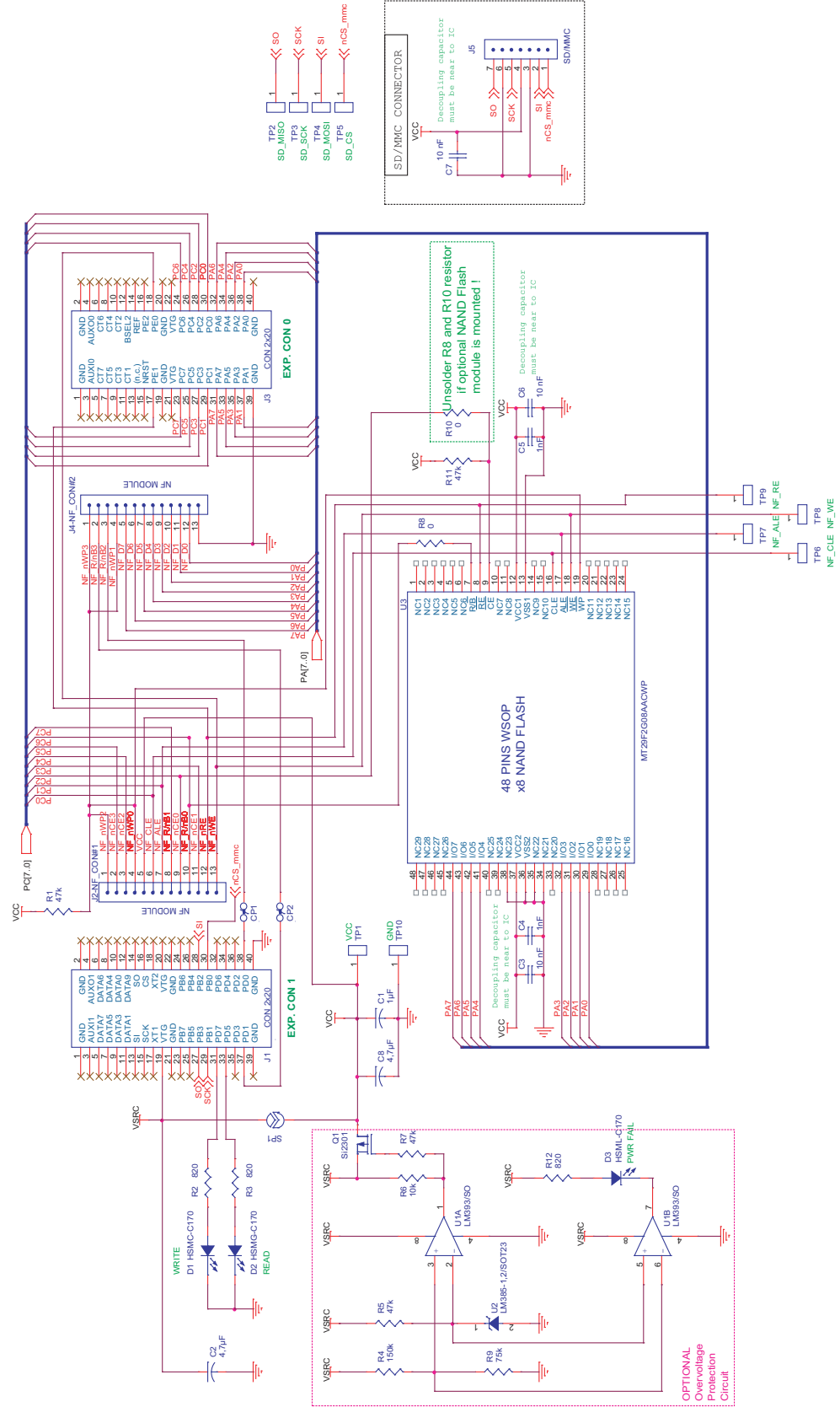

Figure 7-2 . Assembly Drawing, 1 of 1(component side view)

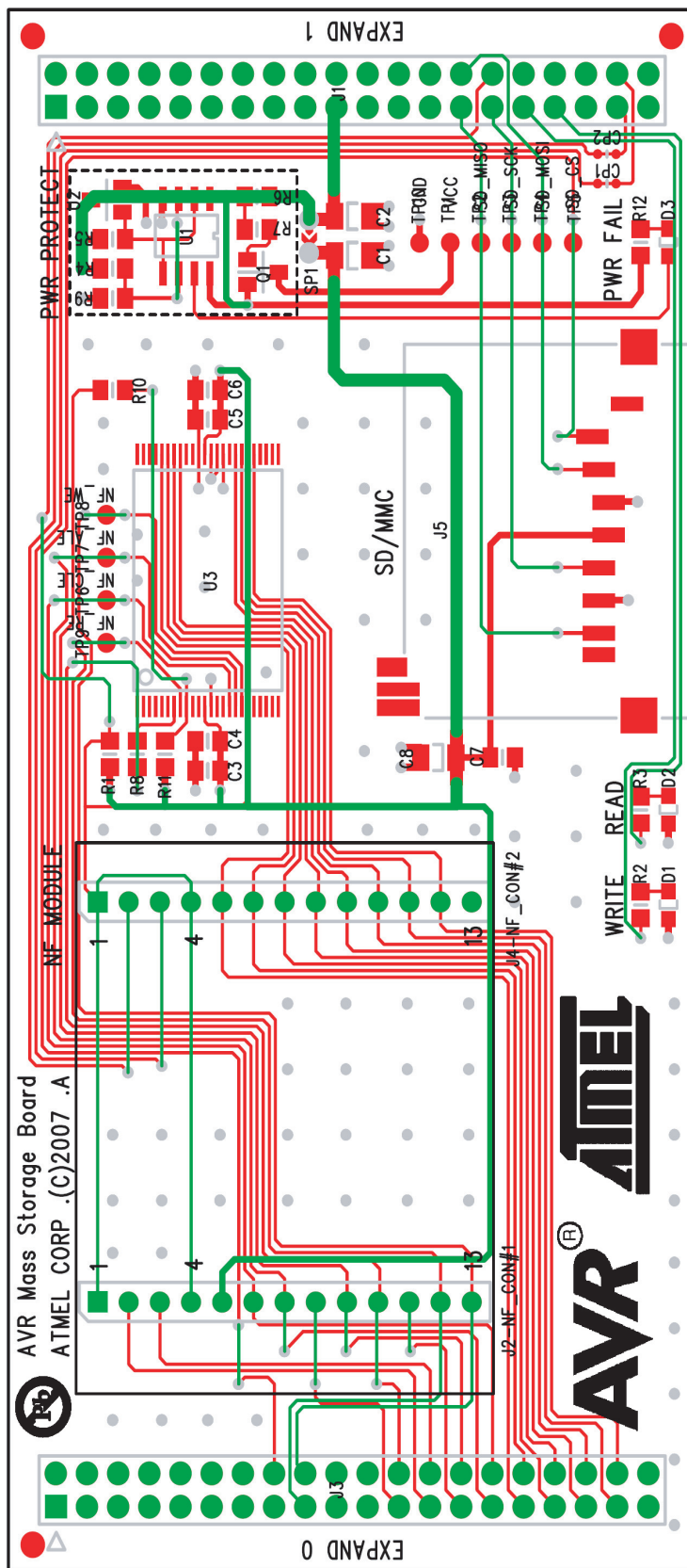

Table 7-1 . Bill of Materials

Qty	Schematic Reference	Part Reference	Description	Case
CAPACITORS				
1	C1	1 μ F	Tantalum 1 μ F 16V capacitor	SMD 3216
2	C2, C8	4.7 μ F	Tantalum 4.7 μ F 16V capacitor	SMD 3216
3	C3, C6, C7	10nF	Ceramic multi-layer 10nF capacitor	SMD 0805
2	C4, C5	1nF	Ceramic multi-layer 1nF capacitor	SMD 0805
DIODES				
1	D1	HSMC-C170	Red LED "WRITE"	SMD 0805
1	D2	HSMG-C170	Green LED "READ"	SMD 0805
1	D3	HSML-C170	Orange LED "PWR_FAIL"	SMD 0805
CONNECTORS				
2	J1, J3	M20-6102005	PC104 2x20-pin through-hole female press-fit stackable connector	2.54mm pitch
1	J5	FPS009-3001	Yamaichi SD/MMC Connector with manual eject	See DS
2	J2, J4		SIP13, 2.54mm pitch, socket for NAND Flash module	2.54mm pitch
CONFIGURATION				
2	CP1, CP2	Configuration Pad	Enabled by default. Can be disabled cutting it.	N/A
1	SP1	Solder Pad	Disabled by default. Can be enabled with a solder drop.	N/A
10	TP1-TP10	Test Point	Solder or touch the testpoint with a probe	Circular pad
RESISTORS				
2	R1, R11	47 KOhms	Resistor 0.1W 1% 47 KOhms	SMD 0805
2	R5, R7	47 KOhms	Resistor 0.1W 1% 47 KOhms	SMD 0805
2	R2, R3	820 Ohms	Resistor 0.1W 1% 820 Ohms	SMD 0805
1	R12	820 Ohms	Resistor 0.1W 1% 820 Ohms	SMD 0805
1	R4	150 KOhms	Resistor 0.1W 1% 150 KOhms	SMD 0805
1	R6	10 KOhms	Resistor 0.1W 1% 10 KOhms	SMD 0805
2	R8, R10	0 Ohms	Resistor 0 Ohms (strap)	SMD 0805
1	R9	75 KOhms	Resistor 0.1W 1% 75KOhms	SMD 0805
INTEGRATED CIRCUITS				
1	U1	LM393M	Double comparator, open collector output	SO-8
1	U2	LM385M3-1.2	Voltage reference 1.235V	SOT-23
1	U3	MT29F2G008AACWP	256Mx8bits NAND Flash memory	TSSOP-48
1	Q1	Si2301BDS	P-Channel low Vgs & Rds(on) FET transistor	SOT-23

Note: The rows with grey background color specify that the corresponding component is not mounted by default (power protection circuit, NAND Flash socket...)

7.0.1 Default Configuration - Summary

Table 7-2. Default Configuration summary

Name	Ref.	Function	State
Solder PADS			
PWR	SP1	Power protection circuit bypassing	SOLDERED
Configuration PADS			
R/nB2	CP1	Connect R/nB signal from NF#2	CLOSED
R/nB3	CP2	Connect R/nB signal from NF#3	CLOSED
Optional components			
Power Protection Circuit	See BOM	Cut power supply if > 3.5V, and lights on PWR_FAIL LED	NOT MOUNTED
NANDFlash socket	J2, J4	Allow plug/unplug of the optional NAND Flash module	NOT MOUNTED



Atmel Corporation

2325 Orchard Parkway
San Jose, CA 95131, USA
Tel: 1(408) 441-0311
Fax: 1(408) 487-2600

Regional Headquarters

Europe

Atmel Sarl
Route des Arsenalux 41
Case Postale 80
CH-1705 Fribourg
Switzerland
Tel: (41) 26-426-5555
Fax: (41) 26-426-5500

Asia

Room 1219
Chinachem Golden Plaza
77 Mody Road Tsimshatsui
East Kowloon
Hong Kong
Tel: (852) 2721-9778
Fax: (852) 2722-1369

Japan

9F, Tonetsu Shinkawa Bldg.
1-24-8 Shinkawa
Chuo-ku, Tokyo 104-0033
Japan
Tel: (81) 3-3523-3551
Fax: (81) 3-3523-7581

Atmel Operations

Memory

2325 Orchard Parkway
San Jose, CA 95131, USA
Tel: 1(408) 441-0311
Fax: 1(408) 436-4314

Microcontrollers

2325 Orchard Parkway
San Jose, CA 95131, USA
Tel: 1(408) 441-0311
Fax: 1(408) 436-4314

La Chantrerie
BP 70602
44306 Nantes Cedex 3, France
Tel: (33) 2-40-18-18-18
Fax: (33) 2-40-18-19-60

ASIC/ASSP/Smart Cards

Zone Industrielle
13106 Rousset Cedex, France
Tel: (33) 4-42-53-60-00
Fax: (33) 4-42-53-60-01

1150 East Cheyenne Mtn. Blvd.
Colorado Springs, CO 80906, USA
Tel: 1(719) 576-3300
Fax: 1(719) 540-1759

Scottish Enterprise Technology Park
Maxwell Building
East Kilbride G75 0QR, Scotland
Tel: (44) 1355-803-000
Fax: (44) 1355-242-743

RF/Automotive

Theresienstrasse 2
Postfach 3535
74025 Heilbronn, Germany
Tel: (49) 71-31-67-0
Fax: (49) 71-31-67-2340

1150 East Cheyenne Mtn. Blvd.
Colorado Springs, CO 80906, USA
Tel: 1(719) 576-3300
Fax: 1(719) 540-1759

Biometrics/Imaging/Hi-Rel MPU/ High Speed Converters/RF Datacom

Avenue de Rochepleine
BP 123
38521 Saint-Egreve Cedex, France
Tel: (33) 4-76-58-30-00
Fax: (33) 4-76-58-34-80

Literature Requests

www.atmel.com/literature

Disclaimer: The information in this document is provided in connection with Atmel products. No license, express or implied, by estoppel or otherwise, to any intellectual property right is granted by this document or in connection with the sale of Atmel products. **EXCEPT AS SET FORTH IN ATMEL'S TERMS AND CONDITIONS OF SALE LOCATED ON ATMEL'S WEB SITE, ATMEL ASSUMES NO LIABILITY WHATSOEVER AND DISCLAIMS ANY EXPRESS, IMPLIED OR STATUTORY WARRANTY RELATING TO ITS PRODUCTS INCLUDING, BUT NOT LIMITED TO, THE IMPLIED WARRANTY OF MERCHANTABILITY, FITNESS FOR A PARTICULAR PURPOSE, OR NON-INFRINGEMENT. IN NO EVENT SHALL ATMEL BE LIABLE FOR ANY DIRECT, INDIRECT, CONSEQUENTIAL, PUNITIVE, SPECIAL OR INCIDENTAL DAMAGES (INCLUDING, WITHOUT LIMITATION, DAMAGES FOR LOSS OF PROFITS, BUSINESS INTERRUPTION, OR LOSS OF INFORMATION) ARISING OUT OF THE USE OR INABILITY TO USE THIS DOCUMENT, EVEN IF ATMEL HAS BEEN ADVISED OF THE POSSIBILITY OF SUCH DAMAGES.** Atmel makes no representations or warranties with respect to the accuracy or completeness of the contents of this document and reserves the right to make changes to specifications and product descriptions at any time without notice. Atmel does not make any commitment to update the information contained herein. Unless specifically provided otherwise, Atmel products are not suitable for, and shall not be used in, automotive applications. Atmel's products are not intended, authorized, or warranted for use as components in applications intended to support or sustain life.

©2008 Atmel Corporation. All rights reserved. Atmel®, logo and combinations thereof, and Everywhere You Are® are the trademarks or registered trademarks, of Atmel Corporation or its subsidiaries. Other terms and product names may be trademarks of others.



Printed on recycled paper.