

SS490 SERIES

005843
Issue 4

Linear Hall-effect Sensor ICs

DESCRIPTION

The SS490 Series are small, versatile, linear Hall-effect devices that are operated by the magnetic field from a permanent magnet or an electromagnet. The ratiometric output voltage is set by the supply voltage and varies in proportion to the strength of the magnetic field. The integrated circuitry provides increased temperature stability and sensitivity. Laser-trimmed, thin film resistors provide high accuracy (null to $\pm\%$, sensitivity up to $\pm 3\%$) and temperature compensation.

They respond to either positive or negative Gauss, monitoring either or both magnetic poles. The quad Hall sensing element minimizes the effects of mechanical or thermal stress on the output. The positive temperature coefficient of the sensitivity ($+0.02\%/^{\circ}\text{C}$ typical) helps compensate for the negative temperature coefficients of low-cost magnets, providing a robust design over a wide temperature range. Rail-to-rail operation (over full voltage range) provides a more usable signal for higher accuracy. These products have an operating temperature range of -40°C to 150°C [-40°F to 302°F], appropriate for industrial and automotive environments.

The SS490B versions offer cost-effective sensing solutions with wider null and sensitivity tolerances, and a wider drift over temperature than the SS490A higher performance products. Both the SS490A and SS490B versions have a typical sinking or sourcing output of 1.5 mA continuous, use 7 mA supply current at 5.0 V at 25°C [77°F], and provide predictable performance over the full temperature range. For design flexibility, these products are available in the following flat TO-92 package styles:

- **SS4XX:** Straight standard leads, bulk pack
- **SS4XX-L:** Straight long leads, bulk pack
- **SS4XX-T2:** Formed leads, ammpack tape-in-box
- **SS4XX-T3:** Straight standard leads, ammpack tape-in-box
- **SS4XX-SP:** Surface mount, pocket tape and reel

POTENTIAL APPLICATIONS

- Basic current sensing for motor load monitoring, detection
- Anti-tampering magnetic field sensor in smart remote utility meters
- Pump control in heavy-duty equipment and household appliances
- Simple linear or angular displacement sensing
- Handlebar/throttle position sensing in e-bikes and scooters
- Current sensing in appliances
- Speed adjustment trigger in tools and appliances
- Magnetic code reading in safes, security and building access control systems

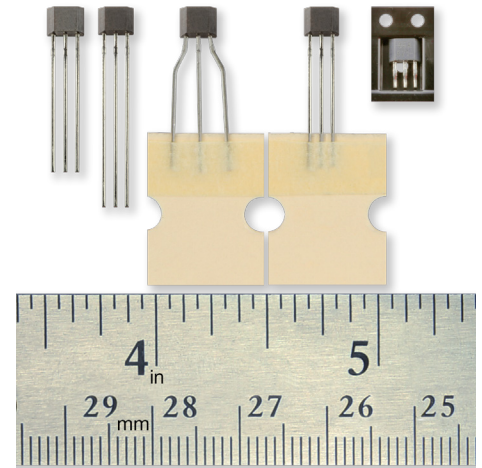

FEATURES

- Linear output for circuit design flexibility
- Quad-Hall IC design minimizes mechanical stress effects
- Responds to either positive or negative Gauss
- Uses 7 mA at 5 Vdc for energy efficiency
- Single current sinking or current sourcing output
- Rail-to-rail operation provides more usable signal for higher accuracy
- Temperature-compensated magnetics help provide stable operation over a wide temperature range of -40°C to 150°C [-40°F to 302°F]



PORTFOLIO

Honeywell offers a variety of linear Hall-effect sensor ICs for potential use in many applications. To view the entire product portfolio, [click here](#).

Honeywell

LINEAR HALL-EFFECT SENSOR ICS

SS490 SERIES

TABLE 1. GENERAL SPECIFICATIONS FOR ALL CATALOG LISTINGS ($V_s = 5.00\text{ V}$ WITH 4.7 K OUTPUT TO MINUS, $T_A = -40^\circ\text{C}$ TO 125°C [-40°F TO 257°F])

Characteristic	Condition	Min.	Typ.	Max.	Unit
Supply current	$T_A = 25^\circ\text{C}$ [77°F]	—	7.0	8.7	mA
Output current:					
sourcing	$V_s > 4.5\text{ V}$	1	1.5	—	mA
sinking	$V_s > 4.5\text{ V}$	0.6	1.5	—	
sinking	$V_s > 5.0\text{ V}$	1	1.5	—	
Response time	—	—	3	—	μs
Output voltage swing:					
VOM-	-B applied	0.4	0.2	—	V
VOM+	+B applied	$V_s - 0.4$	$V_s - 0.2$	—	
Supply voltage	$T_A = -40^\circ\text{C}$ to 125°C [-40°F to 257°F]	-4.5	5.0	10.5	V
Operating temperature	—	-40 [40]	—	150 [302]	$^\circ\text{C}$ [$^\circ\text{F}$]
Soldering temperature and time	wave soldering process: 250°C to 260°C [482°F to 500°F] for 3 s max. infrared reflow process: peak temperature 245°C [473°F] for 10 s max.				

TABLE 2. ABSOLUTE MAXIMUM SPECIFICATIONS FOR ALL CATALOG LISTINGS

Characteristic	Symbol	Condition	Min.	Typ.	Max.	Unit
Supply voltage	V_s	—	-0.5	—	11	V
Output voltage	V_{out}	—	-0.5	—	11	V
Output current	I_{out}	sourcing or sinking	—	—	10	mA
Operating temperature	T_A	—	-55	—	150	$^\circ\text{C}$ [$^\circ\text{F}$]
Storage temperature	T_S	$V_s = 0$	-55	—	165	$^\circ\text{C}$ [$^\circ\text{F}$]

NOTICE

Absolute maximum ratings are the extreme limits the device will momentarily withstand without damage to the device. Electrical and mechanical characteristics are not guaranteed if the rated voltage and/or currents are exceeded, nor will the device necessarily operate at absolute maximum ratings.

NOTICE

The magnetic field strength (Gauss) required to cause the switch to change state (operate and release) will be as specified in the magnetic characteristics. To test the switch against the specified limits, the switch must be placed in a uniform magnetic field.



TABLE 3. SPECIFICATIONS FOR CATALOG LISTING SS494B ($V_s = 5.00\text{ V}$ WITH 4.7 K OUTPUT TO MINUS, $T_A = -40^\circ\text{C}$ TO 125°C [-40°F TO 257°F])

Characteristic	Condition	Min.	Typ.	Max.	Unit
B limits for linear operation	-B max. +B max.	-375 +375	-420 +420	— —	Gauss
Linearity	B = -60 to +60 B = -375 to +375	— 0	— -1.0	— -1.5	% of span
Sensitivity	$T_A = 25^\circ\text{C}$ [77°F]	4.6	5.0	5.4	mV/ Gauss
Null	$T_A = 25^\circ\text{C}$ [77°F]	2.26	2.50	2.74	V
Sensitivity drift	$T_A = -40^\circ\text{C}$ to 25°C [-40°F to 77°F] $T_A = 25^\circ\text{C}$ to 150°C [77°F to 302°F]	0 -0.02	— —	+0.08 +0.08	%/ $^\circ\text{C}$
Vnull drift	B = 0; $T_A = -40^\circ\text{C}$ to 125°C [-40°F to 257°F] B = 0; $T_A = 125^\circ\text{C}$ to 150°C [257°F to 185°F]	-0.064 -0.02	— —	+0.064 +0.08	%/ $^\circ\text{C}$

LINEAR HALL-EFFECT SENSOR ICS

SS490 SERIES

TABLE 4. SPECIFICATIONS FOR CATALOG LISTINGS BEGINNING WITH SS495 (V_s = 5.00 V WITH 4.7 K OUTPUT TO MINUS, T_A = -40°C TO 125°C [-40°F TO 257°F])

Characteristic	Condition	Min.	Typ.	Max.	Unit
SS495A					
B limits for linear operation	-B max. +B max.	-600 +600	-670 +670	— —	Gauss
Linearity	B = -600 to +600	0	-1.0	1.5	% of span
Sensitivity	T _A = 25°C [77°F]	3.00	3.125	3.25	mV/Gauss
Null	T _A = 25°C [77°F]	2.425	2.50	2.575	V
Sensitivity drift	T _A = -40°C to 25°C [-40°F to 77°F] T _A = 25°C to 150°C [77°F to 302°F]	0 -0.01	— —	+0.06 +0.05	%/°C
Vnull drift	B = 0; T _A = 25°C to 125°C [77°F to 257°F] B = 0; T _A = 125°C to 150°C [257°F to 302°F]	-0.06 -0.08	— —	+0.06 +0.08	%/°C
SS495A1					
B limits for linear operation	-B max. +B max.	-600 +600	-670 +670	— —	Gauss
Linearity	B = -600 to +600	0	-1.0	1.5	% of span
Sensitivity	T _A = 25°C [77°F]	3.031	3.125	3.219	mV/Gauss
Null	T _A = 25°C [77°F]	2.425	2.50	2.575	V
Sensitivity drift	T _A = -40°C to 25°C [-40°F to 77°F] T _A = 25°C to 150°C [77°F to 302°F]	0 -0.01	— —	+0.06 +0.05	%/°C
Vnull drift	B = 0; T _A = 25°C to 125°C [77°F to 257°F] B = 0; T _A = 125°C to 150°C [257°F to 302°F]	-0.04 -0.08	— —	+0.04 +0.08	%/°C
SS495A2					
B limits for linear operation	-B max. +B max.	-600 +600	-670 +670	— —	Gauss
Linearity	B = -600 to +600	0	-1.0	1.5	% of span
Sensitivity	T _A = 25°C [77°F]	2.969	3.125	3.281	mV/Gauss
Null	T _A = 25°C [77°F]	2.400	2.50	2.600	V
Sensitivity drift	T _A = -40°C to 25°C [-40°F to 77°F] T _A = 25°C to 150°C [77°F to 302°F]	-0.01 -0.02	— —	+0.07 +0.06	%/°C
Vnull drift	B = 0; T _A = 25°C to 125°C [77°F to 257°F] B = 0; T _A = 125°C to 150°C [257°F to 302°F]	-0.07 -0.08	— —	+0.07 +0.08	%/°C
SS495B					
B limits for linear operation	-B max. +B max.	-600 +600	-670 +670	— —	Gauss
Linearity	B = -600 to +600	0	-1.0	1.5	% of span
Sensitivity	T _A = 25°C [77°F]	2.875	3.125	3.375	mV/Gauss
Null	T _A = 25°C [77°F]	2.350	2.50	2.650	V
Sensitivity drift	T _A = -40°C to 25°C [-40°F to 77°F] T _A = 25°C to 150°C [77°F to 302°F]	-0.02 -0.02	— —	+0.08 +0.08	%/°C
Vnull drift	B = 0; T _A = 25°C to 125°C [77°F to 257°F] B = 0; T _A = 125°C to 150°C [257°F to 302°F]	-0.08 -0.08	— —	+0.08 +0.08	%/°C

LINEAR HALL-EFFECT SENSOR ICs

SS490 SERIES

TABLE 5. SPECIFICATIONS FOR CATALOG LISTINGS BEGINNING WITH SS496 (V_s = 5.00 V WITH 4.7 K OUTPUT TO MINUS, T_A = -40°C TO 125°C [-40°F TO 257°F])

Characteristic	Condition	Min.	Typ.	Max.	Unit
SS496A					
B limits for linear operation	-B max. +B max.	-750 +750	-840 +840	— —	Gauss
Linearity	B = -750 to +750	0	-1.0	1.5	% of span
Sensitivity	T _A = 25°C [77°F]	2.4	2.5	2.575	mV/Gauss
Null	T _A = 25°C [77°F]	2.425	2.50	2.575	V
Sensitivity drift	T _A = -40°C to 25°C [-40°F to 77°F] T _A = 25°C to 125°C [77°F to 257°F]	0 -0.01	— —	+0.06 +0.05	%/°C
Vnull drift	B = 0; T _A = 25°C to 125°C [77°F to 257°F] B = 0; T _A = 125°C to 150°C [257°F to 302°F]	-0.048 -0.064	— —	+0.048 +0.064	%/°C
SS496A1					
B limits for linear operation	-B max. +B max.	-750 +750	-840 +840	— —	Gauss
Linearity	B = -750 to +750	0	-1.0	1.5	% of span
Sensitivity	T _A = 25°C [77°F]	2.425	2.500	2.575	mV/Gauss
Null	T _A = 25°C [77°F]	2.425	2.50	2.575	V
Sensitivity drift	T _A = -40°C to 25°C [-40°F to 77°F] T _A = 25°C to 125°C [77°F to 257°F] T _A = 125°C to 150°C [257°F to 302°F]	0 -0.01 -0.04	— — —	+0.06 +0.05 +0.08	%/°C
Vnull drift	B = 0; T _A = 25°C to 125°C [77°F to 257°F] B = 0; T _A = 125°C to 150°C [257°F to 302°F]	-0.032 -0.064	— —	+0.032 +0.064	%/°C
SS496B					
B limits for linear operation	-B max. +B max.	-750 +750	-840 +840	— —	Gauss
Linearity	B = -750 to +750	0	-1.0	1.5	% of span
Sensitivity	T _A = 25°C [77°F]	2.300	2.500	2.700	mV/Gauss
Null	T _A = 25°C [77°F]	2.350	2.50	2.650	V
Sensitivity drift	T _A = -40°C to 25°C [-40°F to 77°F] T _A = 25°C to 150°C [77°F to 302°F]	-0.02 -0.02	— —	+0.08 +0.08	%/°C
Vnull drift	B = 0; T _A = 25°C to 125°C [77°F to 257°F] B = 0; T _A = 125°C to 150°C [257°F to 302°F]	-0.064 -0.064	— —	+0.064 +0.064	%/°C

FIGURE 1. BLOCK DIAGRAM

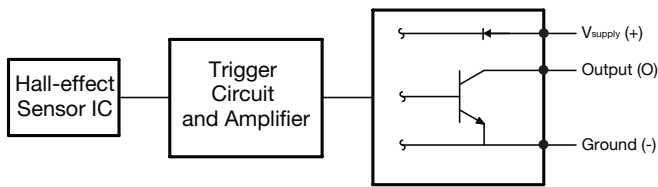

FIGURE 2. MAXIMUM SUPPLY VOLTAGE VS TEMPERATURE

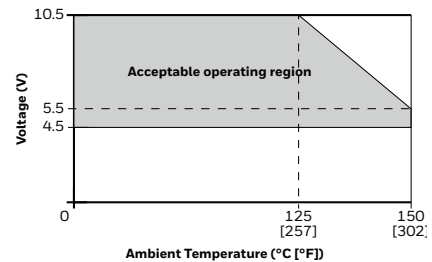
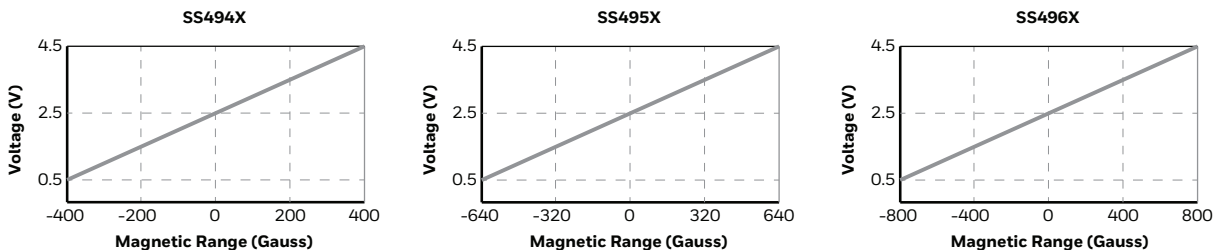

FIGURE 3. TRANSFER CHARACTERISTICS: TYPICAL OUTPUT VOLTAGE



LINEAR HALL-EFFECT SENSOR ICs

SS490 SERIES

FIGURE 5. SS490 SERIES FLAT TO-92-STYLE MOUNTING AND DIMENSIONAL DRAWINGS (CONTINUED)

E. Surface Mount Sensor IC, Pocket Tape and Reel

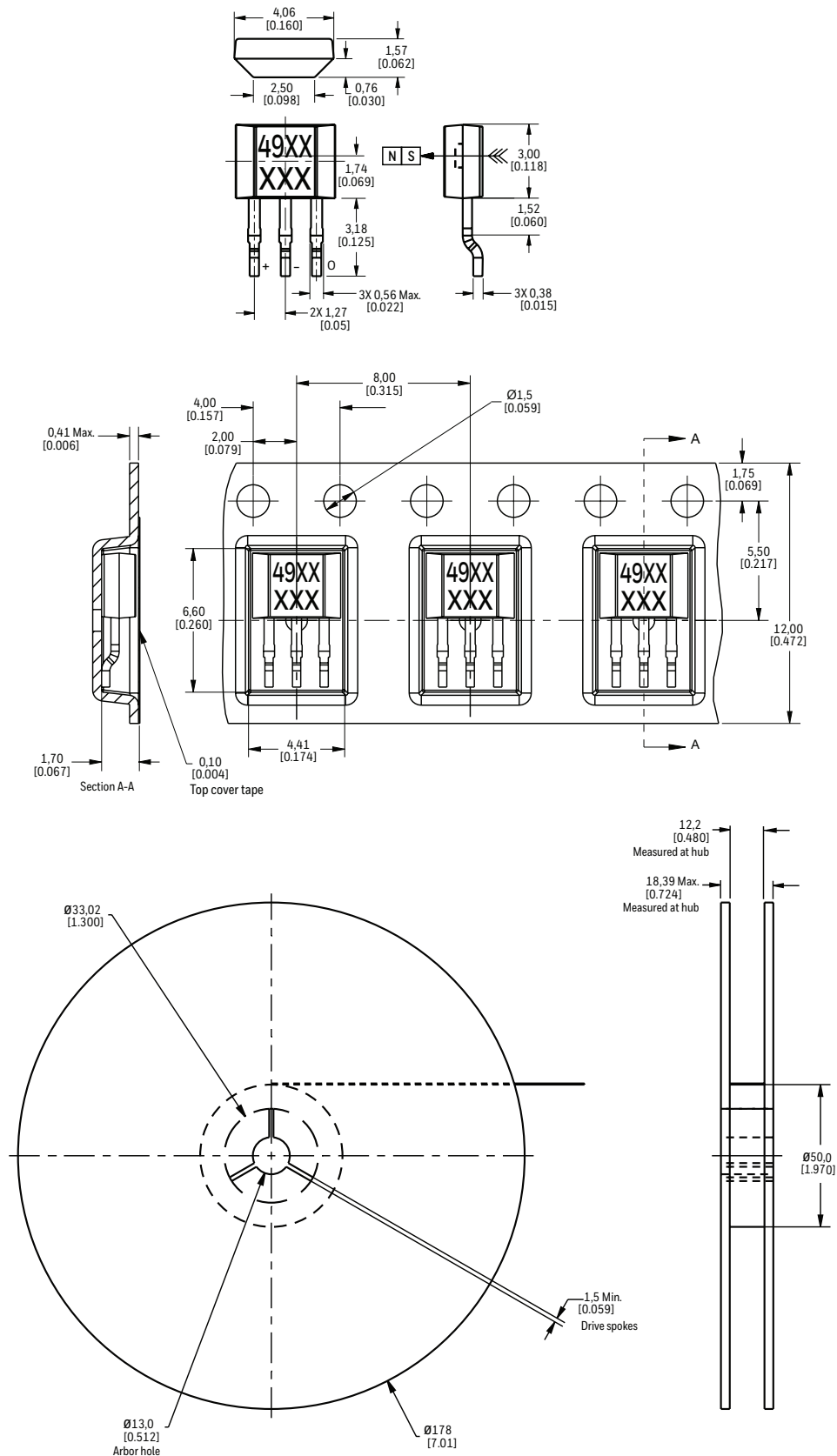

LINEAR HALL-EFFECT SENSOR ICS

SS490 SERIES

TABLE 5. ORDER GUIDE FOR THE SS490 SERIES

Catalog Listing	Description
SS49X: Flat TO-92-style, straight standard leads, bulk pack, 1000 units/bag	
SS494B	See Tables 1, 2, 3 for specifications; Figure 4.A. for dimensions.
SS495A	See Tables 1, 2, 4 for specifications; Figure 4.A. for dimensions.
SS495A1	See Tables 1, 2, 4 for specifications; Figure 4.A. for dimensions.
SS495A2	See Tables 1, 2, 4 for specifications; Figure 4.A. for dimensions.
SS495B	See Tables 1, 2, 4 for specifications; Figure 4.A. for dimensions.
SS496A	See Tables 1, 2, 5 for specifications; Figure 4.A. for dimensions.
SS496A1	See Tables 1, 2, 5 for specifications; Figure 4.A. for dimensions.
SS496B	See Tables 1, 2, 5 for specifications; Figure 4.A. for dimensions.
SS49X-L: Flat TO-92-style, straight long leads, bulk pack, 1000 units/bag	
SS495A-L	See Tables 1, 2, 4 for specifications; Figure 4.B. for dimensions.
SS495A1-L	See Tables 1, 2, 4 for specifications; Figure 4.B. for dimensions.
SS495A2-L	See Tables 1, 2, 4 for specifications; Figure 4.B. for dimensions.
SS49X-T2: Flat TO-92-style, formed leads, ammpack tape-in-box, 5000 units/box	
SS494B-T2	See Tables 1, 2, 3 for specifications; Figure 4.C. for dimensions.
SS495A-T2	See Tables 1, 2, 4 for specifications; Figure 4.C. for dimensions.
SS495A1-T2	See Tables 1, 2, 4 for specifications; Figure 4.C. for dimensions.
SS495A2-T2	See Tables 1, 2, 4 for specifications; Figure 4.C. for dimensions.
SS495B-T2	See Tables 1, 2, 4 for specifications; Figure 4.C. for dimensions.
SS496A-T2	See Tables 1, 2, 5 for specifications; Figure 4.C. for dimensions.
SS496A1-T2	See Tables 1, 2, 5 for specifications; Figure 4.C. for dimensions.
SS496B-T2	See Tables 1, 2, 5 for specifications; Figure 4.C. for dimensions.
SS49X-T2: Flat TO-92-style, straight standard leads, ammpack tape-in-box, 5000 units/box	
SS494B-T3	See Tables 1, 2, 3 for specifications; Figure 4.D. for dimensions.
SS495A-T3	See Tables 1, 2, 4 for specifications; Figure 4.D. for dimensions.
SS495A1-T3	See Tables 1, 2, 4 for specifications; Figure 4.D. for dimensions.
SS495A2-T3	See Tables 1, 2, 4 for specifications; Figure 4.D. for dimensions.
SS495B-T3	See Tables 1, 2, 4 for specifications; Figure 4.D. for dimensions.
SS496A-T3	See Tables 1, 2, 5 for specifications; Figure 4.D. for dimensions.
SS496A1-T3	See Tables 1, 2, 5 for specifications; Figure 4.D. for dimensions.
SS496B-T3	See Tables 1, 2, 5 for specifications; Figure 4.D. for dimensions.
SS49X-SP: Flat TO-92-style, surface mount, pocket tape and reel, 1000 units/reel	
SS494B-SP	See Tables 1, 2, 3 for specifications; Figure 4.E. for dimensions.
SS495A-SP	See Tables 1, 2, 4 for specifications; Figure 4.E. for dimensions.
SS495A1-SP	See Tables 1, 2, 4 for specifications; Figure 4.E. for dimensions.
SS495A2-SP	See Tables 1, 2, 4 for specifications; Figure 4.E. for dimensions.
SS495B-SP	See Tables 1, 2, 4 for specifications; Figure 4.E. for dimensions.
SS496A-SP	See Tables 1, 2, 5 for specifications; Figure 4.E. for dimensions.
SS496A1-SP	See Tables 1, 2, 5 for specifications; Figure 4.E. for dimensions.
SS496B-SP	See Tables 1, 2, 5 for specifications; Figure 4.E. for dimensions.

SS49X



SS49X-L



SS49X-T2



SS49X-T3

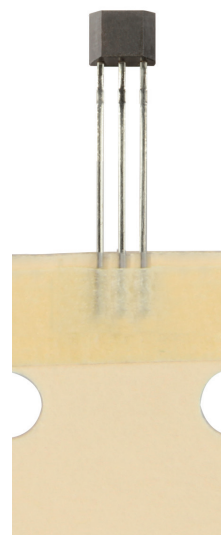

SS49X-SP

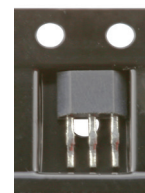

NOTICE

Products ordered in bulk pack (plastic bag) may not have perfectly straight leads as a result of normal handling and shipping operations. Please order a tape packaging option for applications requiring straight leads.

WARRANTY/REMEDY

Honeywell warrants goods of its manufacture as being free of defective materials and faulty workmanship during the applicable warranty period. Honeywell's standard product warranty applies unless agreed to otherwise by Honeywell in writing; please refer to your order acknowledgment or consult your local sales office for specific warranty details. If warranted goods are returned to Honeywell during the period of coverage, Honeywell will repair or replace, at its option, without charge those items that Honeywell, in its sole discretion, finds defective. **The foregoing is buyer's sole remedy and is in lieu of all other warranties, expressed or implied, including those of merchantability and fitness for a particular purpose. In no event shall Honeywell be liable for consequential, special, or indirect damages.**

While Honeywell may provide application assistance personally, through our literature and the Honeywell web site, it is buyer's sole responsibility to determine the suitability of the product in the application.

Specifications may change without notice. The information we supply is believed to be accurate and reliable as of this writing. However, Honeywell assumes no responsibility for its use.

FOR MORE INFORMATION

Honeywell Advanced Sensing Technologies services its customers through a worldwide network of sales offices and distributors. For application assistance, current specifications, pricing or the nearest Authorized Distributor, visit [our website](#) or call:

USA/Canada	+1 302 613 4491
Latin America	+1 305 805 8188
Europe	+44 1344 238258
Japan	+81 (0) 3-6730-7152
Singapore	+65 6355 2828
Greater China	+86 4006396841

Honeywell

Advanced Sensing Technologies

830 East Arapaho Road
Richardson, TX 75081
sps.honeywell.com/ast

WARNING PERSONAL INJURY

DO NOT USE these products as safety or emergency stop devices or in any other application where failure of the product could result in personal injury.

Failure to comply with these instructions could result in death or serious injury.

WARNING MISUSE OF DOCUMENTATION

- The information presented in this product sheet is for reference only. Do not use this document as a product installation guide.
- Complete installation, operation, and maintenance information is provided in the instructions supplied with each product.

Failure to comply with these instructions could result in death or serious injury.