

# Product Document

Published by  
ams OSRAM Group

am<sup>os</sup> OSRAM

# TCS3472

## Color Light-to-Digital Converter with IR Filter

### General Description

The TCS3472 device provides a digital return of red, green, blue (RGB), and clear light sensing values. An IR blocking filter, integrated on-chip and localized to the color sensing photodiodes, minimizes the IR spectral component of the incoming light and allows color measurements to be made accurately. The high sensitivity, wide dynamic range, and IR blocking filter make the TCS3472 an ideal color sensor solution for use under varying lighting conditions and through attenuating materials.

The TCS3472 color sensor has a wide range of applications including RGB LED backlight control, solid-state lighting, health/fitness products, industrial process controls and medical diagnostic equipment. In addition, the IR blocking filter enables the TCS3472 to perform ambient light sensing (ALS). Ambient light sensing is widely used in display-based products such as cell phones, notebooks, and TVs to sense the lighting environment and enable automatic display brightness for optimal viewing and power savings. The TCS3472, itself, can enter a lower-power wait state between light sensing measurements to further reduce the average power consumption.

*Ordering Information and Content Guide appear at end of datasheet.*

### Key Benefits & Features

The benefits and features of TCS3472, Color Light-to-Digital Converter with IR Filter are listed below:

**Figure 1:**  
Added Value of Using TCS3472

Benefits	Features
<ul style="list-style-type: none"> <li>Enables accurate color and light sensing measurements under varying lighting conditions by minimizing IR and UV spectral component effects</li> </ul>	<ul style="list-style-type: none"> <li>Red, Green, Blue (RGB), and Clear Light</li> <li>Sensing with IR blocking filter</li> <li>Programmable analog gain and integration time</li> <li>3,800,000:1 dynamic range</li> <li>Very high sensitivity - ideally suited for operation behind dark glass</li> </ul>
<ul style="list-style-type: none"> <li>Programmable interrupt pin enables level-style interrupts when pre-set values are exceeded, thus reducing companion micro-processor overhead</li> </ul>	<ul style="list-style-type: none"> <li>Maskable interrupt</li> <li>Programmable upper and lower thresholds with persistence filter</li> </ul>

Benefits	Features
<ul style="list-style-type: none"> <li>Enabling a low-power wait-state between RGBC measurements to reduce average power consumption</li> </ul>	<ul style="list-style-type: none"> <li>Power management</li> <li>Low power - 2.5µA sleep state</li> <li>65µA wait state with programmable wait state time from 2.4ms to &gt; 7 seconds</li> </ul>
<ul style="list-style-type: none"> <li>Digital interfaces are less susceptible to noise</li> </ul>	<ul style="list-style-type: none"> <li>I<sup>2</sup>C fast mode compatible interface</li> <li>Data rates up to 400 kbit/s</li> <li>Input voltage levels compatible with V<sub>DD</sub> or 1.8 V<sub>BUS</sub></li> </ul>
<ul style="list-style-type: none"> <li>Backward compatibility enables interchangeability and re-usability in systems</li> </ul>	<ul style="list-style-type: none"> <li>Register set and pin compatible with the TCS3x71 series</li> </ul>
<ul style="list-style-type: none"> <li>Reduces PCB space requirements while simplifying designs</li> </ul>	<ul style="list-style-type: none"> <li>Small 2mm x 2.4mm dual flat no-lead</li> <li>FN package</li> </ul>

### Applications

The applications of TCS3472 include:

- RGB LED backlight control
- Light color temperature measurement
- Ambient light sensing for display backlight control
- Fluid and gas analysis
- Product color verification and sorting

### End Products and Market Segments

- TVs, mobile handsets, tablets, computers, and monitors
- Consumer and commercial printing
- Medical and health fitness
- Solid state lighting (SSL) and digital signage
- Industrial automation

### Block Diagram

The functional blocks of this device are shown below:

**Figure 2:**  
Functional Block Diagram

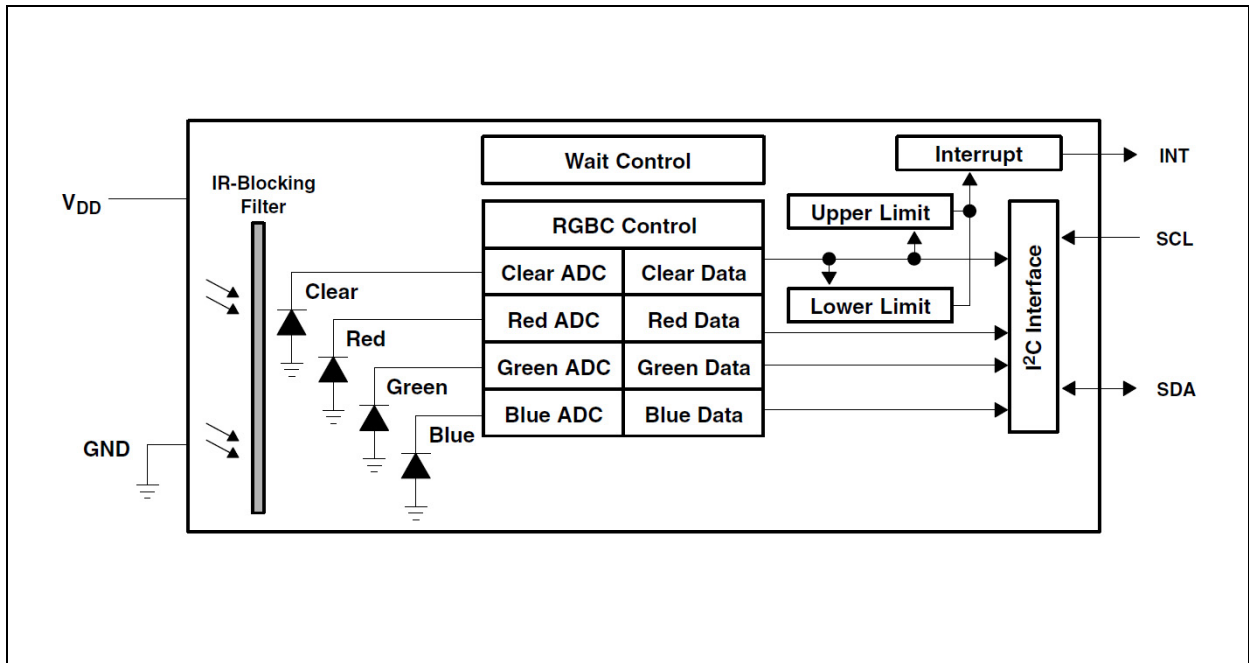

## Detailed Description

The TCS3472 light-to-digital converter contains a  $3 \times 4$  photodiode array, four analog-to-digital converters (ADC) that integrate the photodiode current, data registers, a state machine, and an I<sup>2</sup>C interface. The  $3 \times 4$  photodiode array is composed of red-filtered, green-filtered, blue-filtered, and clear (unfiltered) photodiodes. In addition, the photodiodes are coated with an IR-blocking filter. The four integrating ADCs simultaneously convert the amplified photodiode currents to a 16-bit digital value. Upon completion of a conversion cycle, the results are transferred to the data registers, which are double-buffered to ensure the integrity of the data. All of the internal timing, as well as the low-power wait state, is controlled by the state machine.

Communication of the TCS3472 data is accomplished over a fast, up to 400 kHz, two-wire I<sup>2</sup>C serial bus. The industry standard I<sup>2</sup>C bus facilitates easy, direct connection to microcontrollers and embedded processors.

In addition to the I<sup>2</sup>C bus, the TCS3472 provides a separate interrupt signal output. When interrupts are enabled, and user-defined thresholds are exceeded, the active-low interrupt is asserted and remains asserted until it is cleared by the controller. This interrupt feature simplifies and improves the efficiency of the system software by eliminating the need to poll the TCS3472. The user can define the upper and lower interrupt thresholds and apply an interrupt persistence filter. The interrupt persistence filter allows the user to define the number of consecutive out-of-threshold events necessary before generating an interrupt. The interrupt output is open-drain, so it can be wire-ORed with other devices.

## Pin Assignment

The TCS3472 pin assignment is described below.

**Figure 3:**  
Pin Diagram

**Package FN Dual Flat No-Lead (Top View):** Package drawing is not to scale.

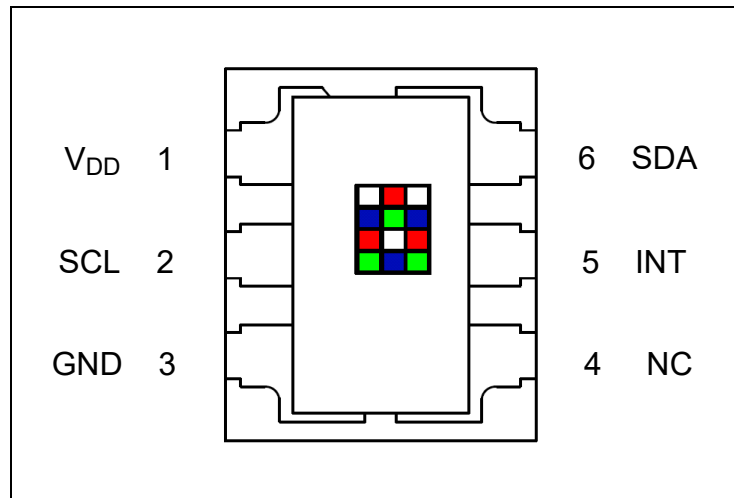

**Figure 4:**  
Pin Description

Pin Number	Pin Name	Pin Type	Description
1	V <sub>DD</sub>		Supply voltage
2	SCL	Input	I <sup>2</sup> C serial clock input terminal – clock signal for I <sup>2</sup> C serial data
3	GND		Power supply ground. All voltages are referenced to GND
4	NC	Output	No connect - do not connect
5	INT	Output	Interrupt - open drain (active low).
6	SDA	Input/Output	I <sup>2</sup> C serial data I/O terminal - serial data I/O for I <sup>2</sup> C.

## Absolute Maximum Ratings

Stresses beyond those listed under [Absolute Maximum Ratings](#) may cause permanent damage to the device. These are stress ratings only. Functional operation of the device at these or any other conditions beyond those indicated under [Recommended Operating Conditions](#) is not implied. Exposure to absolute maximum rated conditions for extended periods may affect device reliability.

**Figure 5:**  
**Absolute Maximum Ratings over Operating Free-Air Temperature Range (unless otherwise noted)**

Parameter	Min	Max	Units	Comments
Supply voltage, $V_{DD}$		3.8	V	All voltages are with respect to GND
Input terminal voltage	- 0.5	3.8	V	
Output terminal voltage	- 0.5	3.8	V	
Output terminal current	- 1	20	mA	
Storage temperature range, $T_{strg}$	- 40	85	°C	
ESD tolerance, human body model	±2000		V	

## Electrical Characteristics

All limits are guaranteed. The parameters with min and max values are guaranteed with production tests or SQC (Statistical Quality Control) methods.

**Figure 6:**  
Recommended Operating Conditions

Symbol	Parameter	Conditions	Min	Typ	Max	Units
$V_{DD}$	Supply voltage	TCS34725 ( $I^2C V_{BUS} = V_{DD}$ )	2.7	3	3.6	V
		TCS34727 ( $I^2C V_{BUS} = 1.8 V$ )	2.7	3	3.3	
$T_A$	Operating free - air temperature		-30		70	°C

**Figure 7:**  
Operating Characteristics,  $V_{DD} = 3 V$ ,  $T_A = 25^\circ C$  (unless otherwise noted)

Symbol	Parameter	Conditions	Min	Typ	Max	Units
$I_{DD}$	Supply current	Active		235	330	$\mu A$
		Wait state		65		
		Sleep state - no $I^2C$ activity		2.5	10	
$V_{OL}$	INT SDA output low voltage	3 mA sink current	0		0.4	V
		6 mA sink current	0		0.6	
$I_{LEAK}$	Leakage current, SDA, SCL, INT pins		-5		5	$\mu A$
	Leakage current, LDR pin		-5		5	
$V_{IH}$	SCL SDA input high voltage	TCS34725	$0.7 V_{DD}$			V
		TCS34727	1.25			
$V_{IL}$	SCL SDA input low voltage	TCS34725			$0.3 V_{DD}$	V
		TCS34727			0.54	



**Figure 8:**  
 Optical Characteristics,  $V_{DD}=3\text{ V}$ ,  $T_A=25^\circ\text{C}$ ,  $\text{AGAIN} = 16$ ,  $\text{ATIME} = 0xF6$  (unless otherwise noted)<sup>(1)</sup>

Parameter	Test Conditions	Red Channel		Green Channel		Blue Channel		Clear Channel			Unit
		Min	Max	Min	Max	Min	Max	Min	Typ	Max	
R <sub>e</sub> Irradiance responsivity	$\lambda_D = 465\text{ nm}^{(2)}$	0%	15%	10%	42%	65%	88%	11.0	13.8	16.6	counts / $\mu\text{W}$ / $\text{cm}^2$
	$\lambda_D = 525\text{ nm}^{(3)}$	4%	25%	60%	85%	10%	45%	13.2	16.6	20.0	
	$\lambda_D = 615\text{ nm}^{(4)}$	80%	110%	0%	14%	5%	24%	15.6	19.5	23.4	

**Notes:**

1. The percentage shown represents the ratio of the respective red, green, or blue channel value to the clear channel value.
2. The 465 nm input irradiance is supplied by an InGaN light-emitting diode with the following characteristics: dominant wavelength  $\lambda_D = 465\text{ nm}$ , spectral halfwidth  $\Delta\lambda_{1/2} = 22\text{ nm}$ .
3. The 525 nm input irradiance is supplied by an InGaN light-emitting diode with the following characteristics: dominant wavelength  $\lambda_D = 525\text{ nm}$ , spectral halfwidth  $\Delta\lambda_{1/2} = 35\text{ nm}$ .
4. The 615 nm input irradiance is supplied by a AlInGaP light-emitting diode with the following characteristics: dominant wavelength  $\lambda_D = 615\text{ nm}$ , spectral halfwidth  $\Delta\lambda_{1/2} = 15\text{ nm}$ .

**Figure 9:**  
**RGBC Characteristics,  $V_{DD} = 3\text{ V}$ ,  $T_A = 25^\circ\text{C}$ ,  $\text{AGAIN} = 16$ ,  $\text{AEN} = 1$  (unless otherwise noted)**

Parameter	Conditions	Min	Typ	Max	Units
Dark ADC count value	$E_e = 0$ , $\text{AGAIN} = 60\times$ , $\text{ATIME} = 0xD6$ (100 ms)	0	1	5	counts
ADC integration time step size	$\text{ATIME} = 0xFF$	2.27	2.4	2.56	ms
ADC number of integration steps <sup>(1)</sup>		1		256	steps
ADC counts per step <sup>(1)</sup>		0		1024	counts
ADC count value <sup>(1)</sup>	$\text{ATIME} = 0xC0$ (153.6 ms)	0		65535	counts
Gain scaling, relative to 1X gain setting	4X	3.8	4	4.2	X
	16X	15	16	16.8	
	60X	58	60	63	

**Note(s):**

1. Parameter ensured by design and is not tested.

**Figure 10:**  
**Wait Characteristics,  $V_{DD} = 3\text{ V}$ ,  $T_A = 25^\circ\text{C}$ ,  $\text{WEN} = 1$  (unless otherwise noted)**

Parameter	Conditions	Channel	Min	Typ	Max	Units
Wait step size	$\text{WTIME} = 0xFF$		2.27	2.4	2.56	ms
Wait number of integration steps <sup>(1)</sup>			1		256	steps

**Note(s):**

1. Parameter ensured by design and is not tested.

## Timing Characteristics

The timing characteristics of TCS3472 are given below.

**Figure 11:**  
AC Electrical Characteristics,  $V_{DD} = 3\text{ V}$ ,  $T_A = 25^\circ\text{C}$  (unless otherwise noted)

Parameter	Description	Min	Typ	Max	Units
$f_{(SCL)}$	Clock frequency (I <sup>2</sup> C only)	0		400	kHz
$t_{(BUF)}$	Bus free time between start and stop condition	1.3			$\mu\text{s}$
$t_{(HDSTA)}$	Hold time after (repeated) start condition. After this period, the first clock is generated.	0.6			$\mu\text{s}$
$t_{(SUSTA)}$	Repeated start condition setup time	0.6			$\mu\text{s}$
$t_{(SUSTO)}$	Stop condition setup time	0.6			$\mu\text{s}$
$t_{(HDDAT)}$	Data hold time	0		0.9	$\mu\text{s}$
$t_{(SUDAT)}$	Data setup time	100			ns
$t_{(LOW)}$	SCL clock low period	1.3			$\mu\text{s}$
$t_{(HIGH)}$	SCL clock high period	0.6			$\mu\text{s}$
$t_F$	Clock/data fall time			300	ns
$t_R$	Clock/data rise time			300	ns
$C_i$	Input pin capacitance			10	pF

**Note(s):**

1. Specified by design and characterization; not production tested.

## Timing Diagram

**Figure 12:**  
Parameter Measurement Information

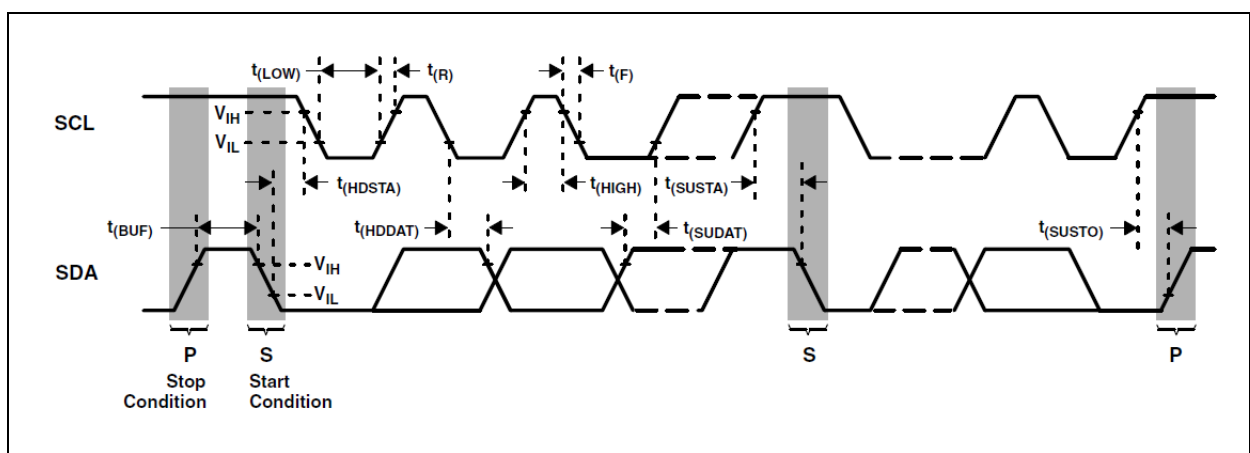

## Typical Operating Characteristics

Figure 13:  
Photodiode Spectral Responsivity RGBC

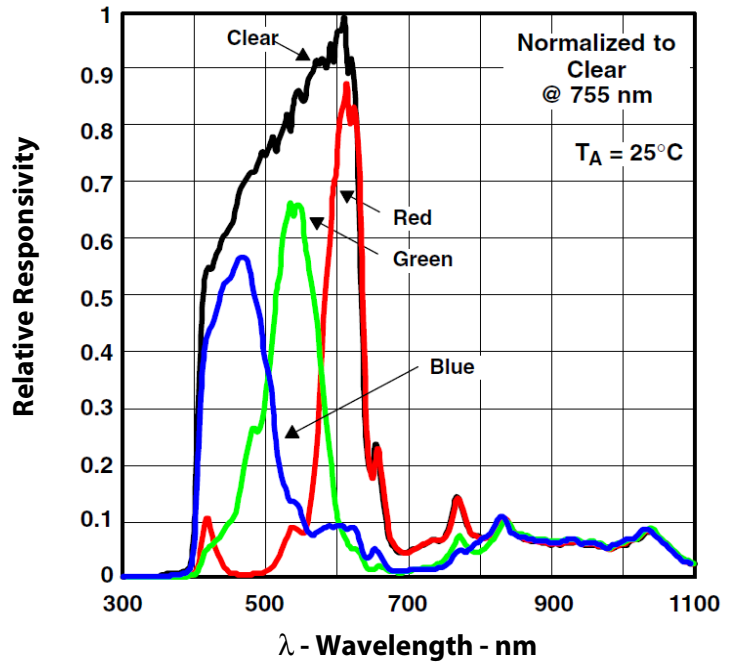

Figure 14:  
Normalized Responsivity vs. Angular Displacement

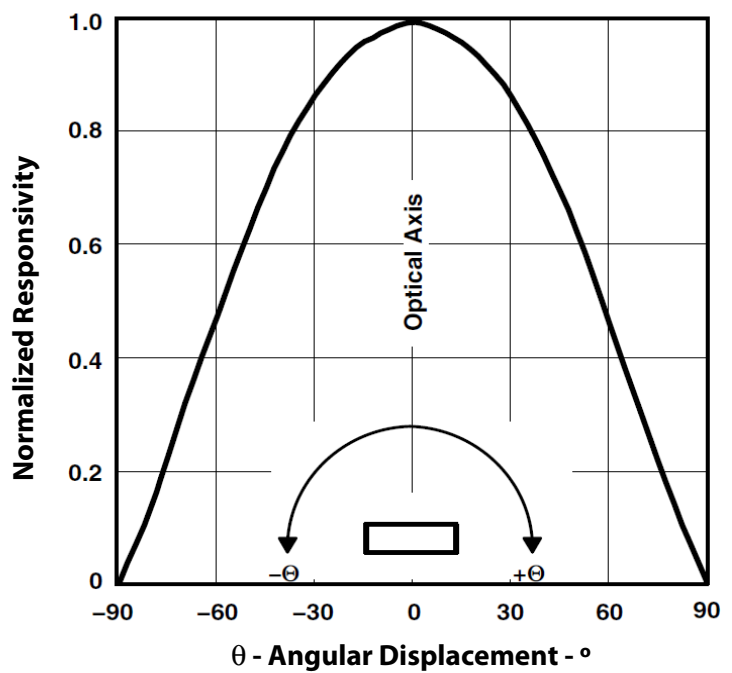

Figure 15:  
Normalized  $I_{DD}$  vs.  $V_{DD}$  and Temperature

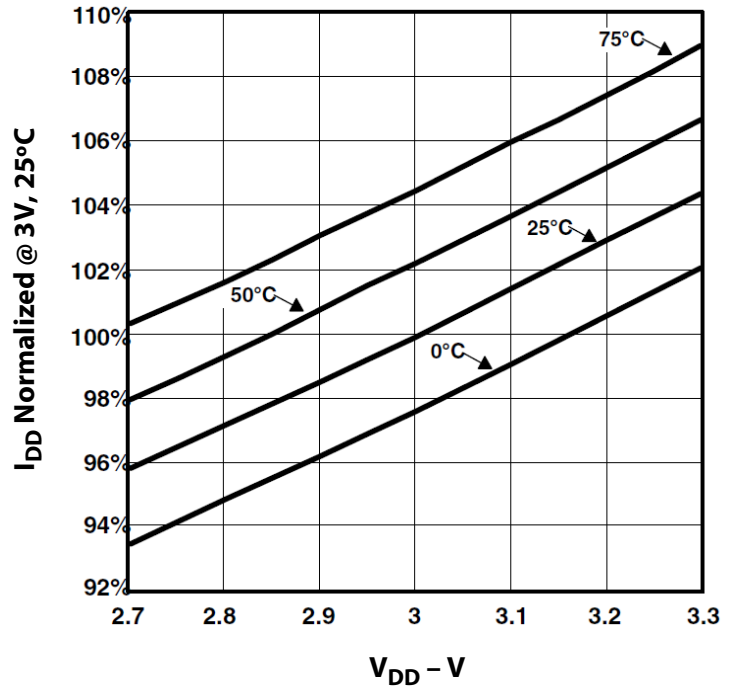
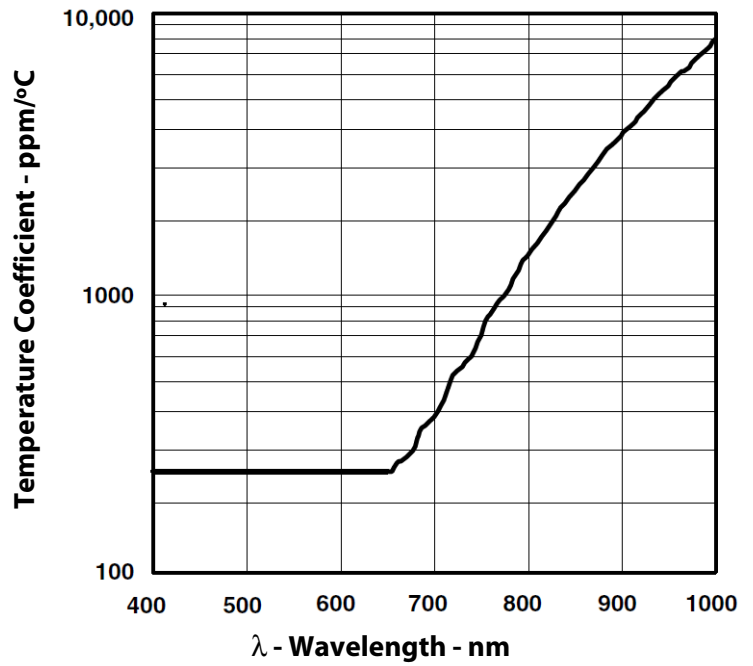

Figure 16:  
Responsivity Temperature Coefficient



## Principles of Operation

### System States

An internal state machine provides system control of the RGBC and power management features of the device. At power up, an internal power-on-reset initializes the device and puts it in a low-power Sleep state.

When a start condition is detected on the I<sup>2</sup>C bus, the device transitions to the Idle state where it checks the Enable Register (0x00) PON bit. If PON is disabled, the device will return to the Sleep state to save power. Otherwise, the device will remain in the Idle state until the RGBC function is enabled (AEN). Once enabled, the device will execute the Wait and RGBC states in sequence as indicated in Figure 16. Upon completion and return to Idle, the device will automatically begin a new Wait-RGBC cycle as long as PON and AEN remain enabled.

Figure 17:  
Simplified State Diagram

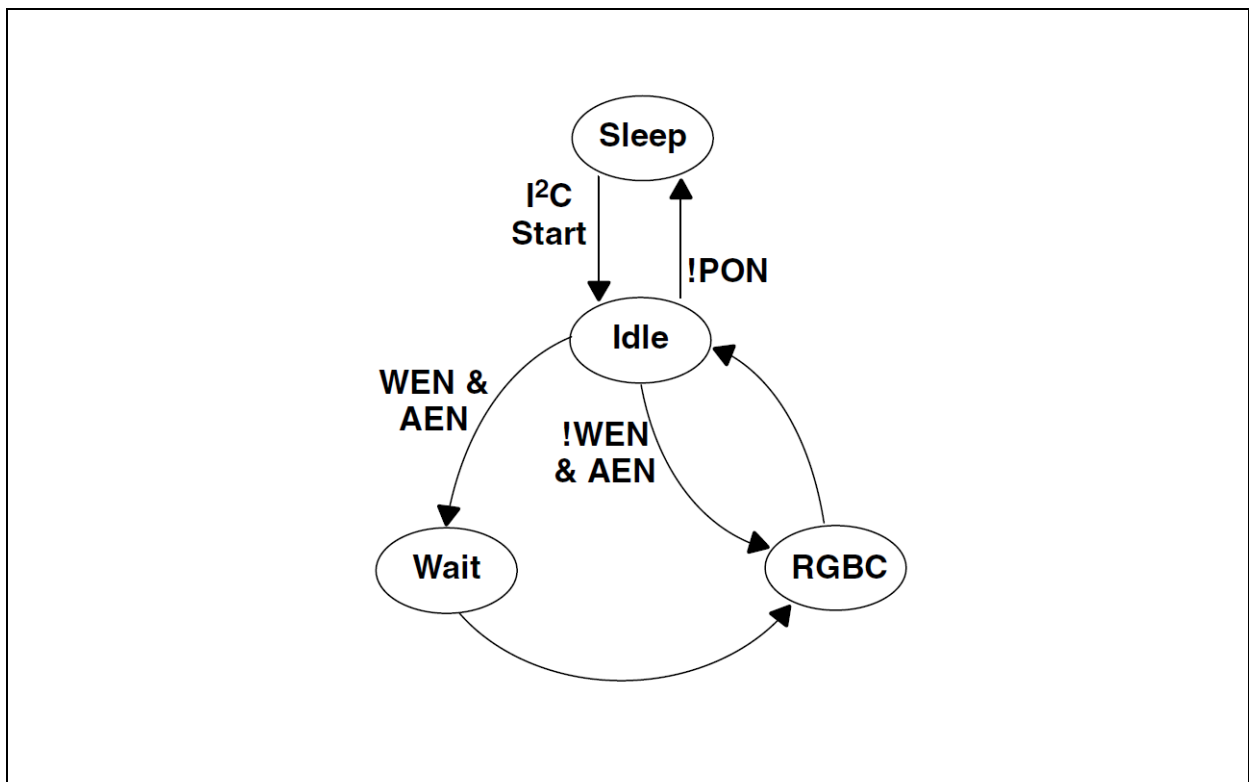

### RGBC Operation

The RGBC engine contains RGBC gain control (AGAIN) and four integrating analog-to-digital converters (ADC) for the RGBC photodiodes. The RGBC integration time (ATIME) impacts both the resolution and the sensitivity of the RGBC reading. Integration of all four channels occurs simultaneously and upon completion of the conversion cycle, the results are transferred to the color data registers. This data is also referred to as channel *count*.

The transfers are double-buffered to ensure that invalid data is not read during the transfer. After the transfer, the device automatically moves to the next state in accordance with the configured state machine.

**Figure 18:**  
RGBC Operation

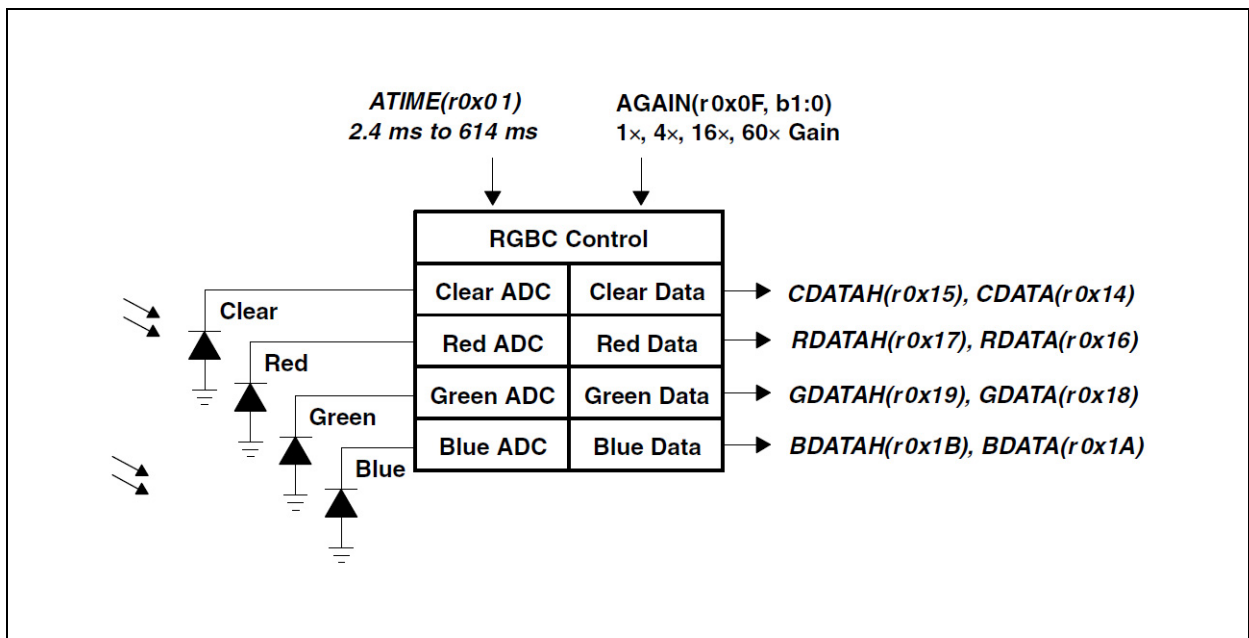

**Note(s):**

1. In this document, the nomenclature uses the bit field name in italics followed by the register address and bit number to allow the user to easily identify the register and bit that controls the function. For example, the power on (PON) is in register 0x00, bit 0. This is represented as *PON (r0x00:b0)*.

The registers for programming the integration and wait times are a 2's complement values. The actual time can be calculated as follows:

$$ATIME = 256 - \text{Integration Time} / 2.4 \text{ ms}$$

Inversely, the time can be calculated from the register value as follows:

$$\text{Integration Time} = 2.4 \text{ ms} \times (256 - ATIME)$$

For example, if a 100-ms integration time is needed, the device needs to be programmed to:

$$256 - (100 / 2.4) = 256 - 42 = 214 = 0xD6$$

Conversely, the programmed value of 0xC0 would correspond to:

$$(256 - 0xC0) \times 2.4 = 64 \times 2.4 = 154 \text{ ms.}$$

## Interrupts

The interrupt feature simplifies and improves system efficiency by eliminating the need to poll the sensor for light intensity values outside of a user-defined range. While the interrupt function is always enabled and its status is available in the status register (0x13), the output of the interrupt state can be enabled using the RGBC interrupt enable (AIEN) field in the enable register (0x00).

Two 16-bit interrupt threshold registers allow the user to set limits below and above a desired light level. An interrupt can be generated when the Clear data (CDATA) is less than the Clear interrupt low threshold (AILTx) or is greater than the Clear interrupt high threshold (AIHTx).

It is important to note that the thresholds are evaluated in sequence, first the low threshold, then the high threshold. As a result, if the low threshold is set above the high threshold, the high threshold is ignored and only the low threshold is evaluated.



To further control when an interrupt occurs, the device provides a persistence filter. The persistence filter allows the user to specify the number of consecutive out-of-range Clear occurrences before an interrupt is generated. The persistence filter register (0x0C) allows the user to set the Clear persistence filter (APERS) value. See the persistence filter register for details on the persistence filter value. Once the persistence filter generates an interrupt, it will continue until a special function interrupt clear command is received (see command register).

**Figure 19:**  
Programmable Interrupt

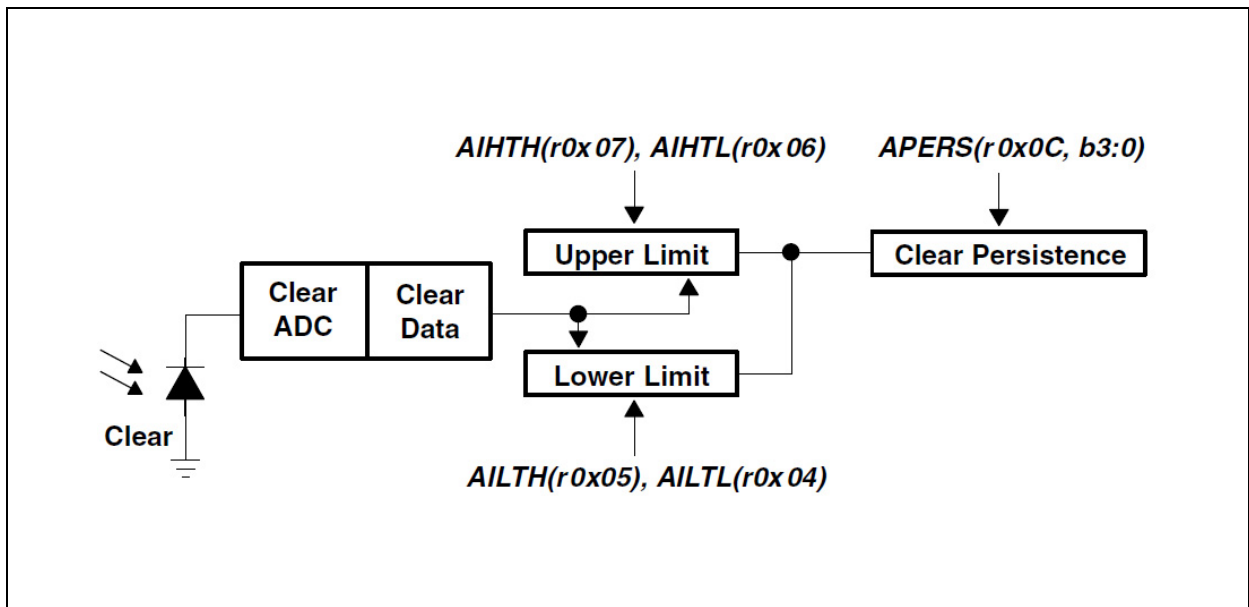

### System Timing

The system state machine shown in [Figure 17](#) provides an overview of the states and state transitions that provide system control of the device. This section highlights the programmable features, which affect the state machine cycle time, and provides details to determine system level timing.

When the power management feature is enabled (WEN), the state machine will transition to the Wait state. The wait time is determined by WLONG, which extends normal operation by 12x when asserted, and WTIME. The formula to determine the wait time is given in the box associated with the Wait state in [Figure 20](#).

When the RGBC feature is enabled (AEN), the state machine will transition through the RGBC Init and RGBC ADC states. The RGBC Init state takes 2.4 ms, while the RGBC ADC time is dependent on the integration time (ATIME). The formula to determine RGBC ADC time is given in the associated box in [Figure 20](#). If an interrupt is generated as a result of the RGBC cycle, it will be asserted at the end of the RGBC ADC.

**Figure 20:**  
Detailed State Diagram

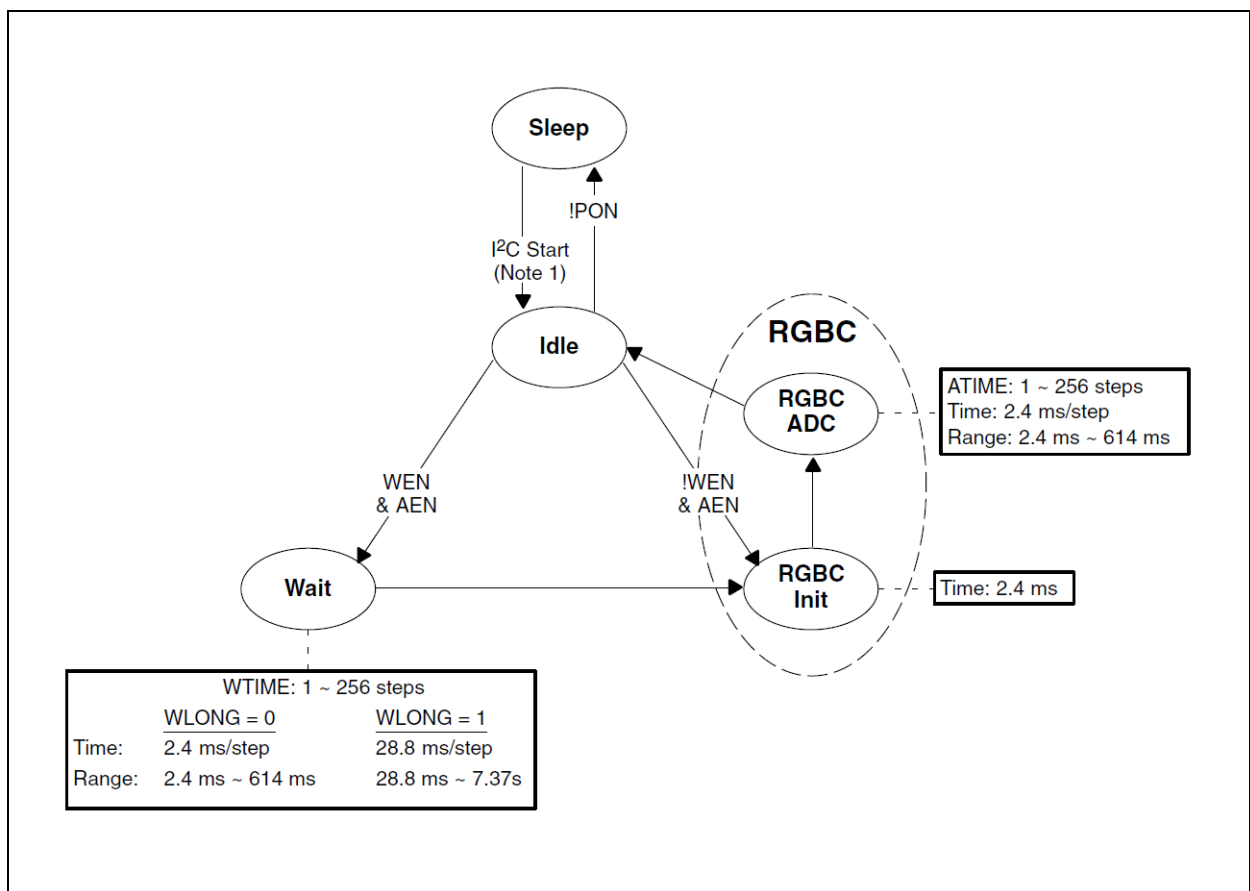

**Notes:**

1. There is a 2.4 ms warm-up delay if PON is enabled. If PON is not enabled, the device will return to the Sleep state as shown.
2. PON, WEN, and AEN are fields in the Enable register (0x00).

## Power Management

Power consumption can be managed with the Wait state, because the Wait state typically consumes only 65  $\mu\text{A}$  of  $I_{\text{DD}}$  current. An example of the power management feature is given below. With the assumptions provided in the example, average  $I_{\text{DD}}$  is estimated to be 152  $\mu\text{A}$ .

**Figure 21:**  
Power Management

System State Machine State	Programmable Parameter	Programmed Value	Duration	Typical Current
Wait	WTIME	0xEE	43.2 ms	0.065 mA
	WLONG	0		
RGBC Init			2.40 ms	0.235 mA
RGBC ADC	ATIME	0xEE	43.2 ms	0.235 mA

$$\text{Average } I_{\text{DD}} \text{ Current} = ((43.2 \times 0.065) + (43.2 \times 0.235) + (2.40 \times 0.235)) / 89 \approx 152 \mu\text{A}$$

Keeping with the same programmed values as the example, [Figure 22](#) shows how the average  $I_{\text{DD}}$  current is affected by the Wait state time, which is determined by WEN, WTIME, and WLONG. Note that the worst-case current occurs when the Wait state is not enabled.

**Figure 22:**  
Average  $I_{\text{DD}}$  Current

WEN	WTIME	WLONG	WAIT State	Average $I_{\text{DD}}$ Current
0	n/a	n/a	0 ms	291 $\mu\text{A}$
1	0xFF	0	2.40 ms	280 $\mu\text{A}$
1	0xEE	0	43.2 ms	152 $\mu\text{A}$
1	0x00	0	614 ms	82 $\mu\text{A}$
1	0x00	1	7.37 s	67 $\mu\text{A}$

## I<sup>2</sup>C Protocol

Interface and control are accomplished through an I<sup>2</sup>C serial compatible interface (standard or fast mode) to a set of registers that provide access to device control functions and output data. The devices support the 7-bit I<sup>2</sup>C addressing protocol.

The I<sup>2</sup>C standard provides for three types of bus transaction: read, write, and a combined protocol (Figure 23). During a write operation, the first byte written is a command byte followed by data. In a combined protocol, the first byte written is the command byte followed by reading a series of bytes. If a read command is issued, the register address from the previous command will be used for data access. Likewise, if the MSB of the command is not set, the device will write a series of bytes at the address stored in the last valid command with a register address. The command byte contains either control information or a 5-bit register address. The control commands can also be used to clear interrupts.

The I<sup>2</sup>C bus protocol was developed by Philips (now NXP). For a complete description of the I<sup>2</sup>C protocol, please review the NXP I<sup>2</sup>C design specification at [www.i2c-bus.org/references/](http://www.i2c-bus.org/references/).

Figure 23:  
I<sup>2</sup>C Protocols

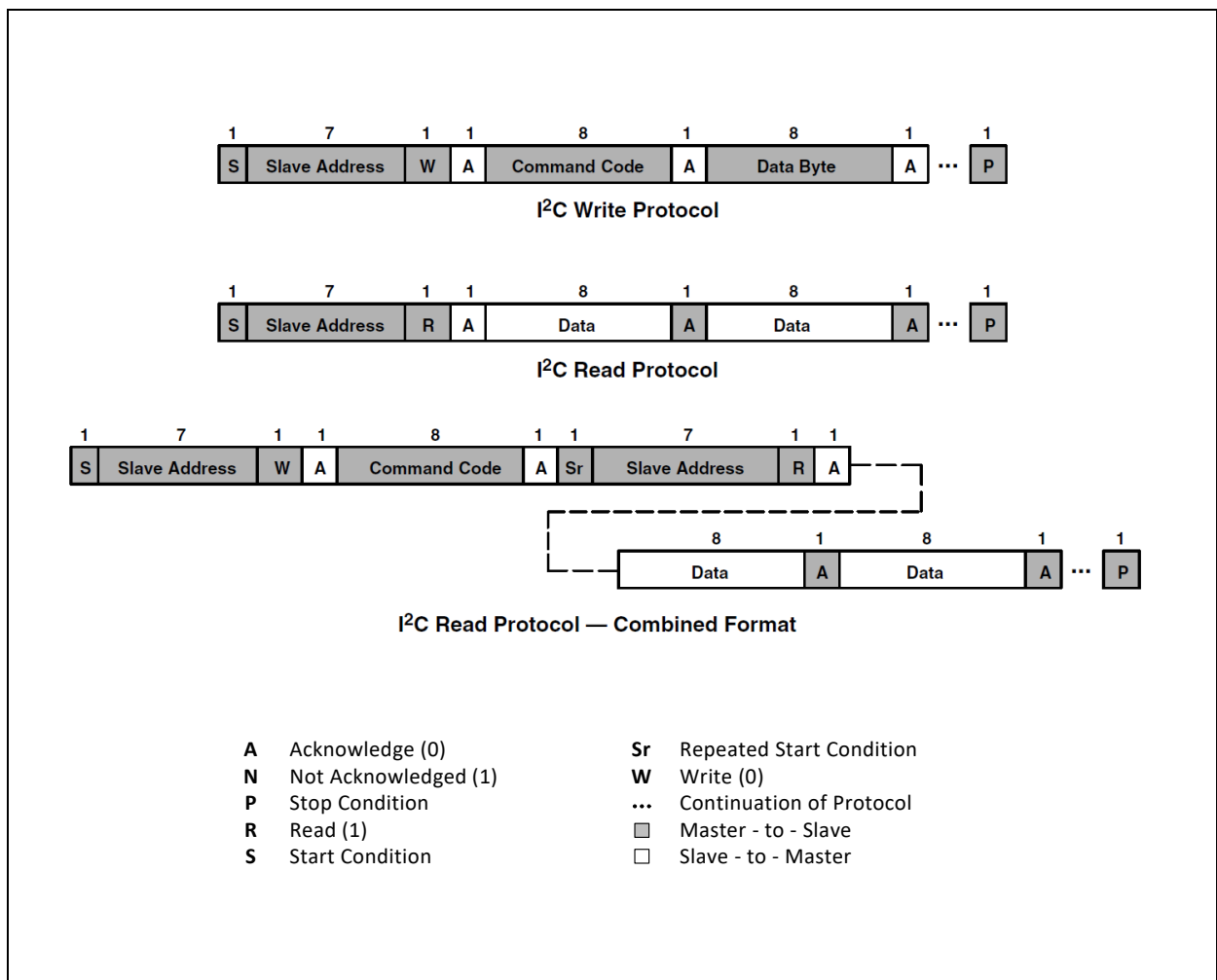

## Register Description

The TCS3472 is controlled and monitored by data registers and a command register accessed through the serial interface. These registers provide for a variety of control functions and can be read to determine results of the ADC conversions. The register set is summarized in [Figure 24](#).

**Figure 24:**  
Register Set

Address	Register Name	R/W	Register Function	Reset Value
--	COMMAND	W	Specifies register address	0x00
0x00	ENABLE	R/W	Enables states and interrupts	0x00
0x01	ATIME	R/W	RGBC time	0xFF
0x03	WTIME	R/W	Wait time	0xFF
0x04	AILTL	R/W	Clear interrupt low threshold low byte	0x00
0x05	AILTH	R/W	Clear interrupt low threshold high byte	0x00
0x06	AIHTL	R/W	Clear interrupt high threshold low byte	0x00
0x07	AIHTH	R/W	Clear interrupt high threshold high byte	0x00
0x0C	PERS	R/W	Interrupt persistence filter	0x00
0x0D	CONFIG	R/W	Configuration	0x00
0x0F	CONTROL	R/W	Control	0x00
0x12	ID	R	Device ID	ID
0x13	STATUS	R	Device status	0x00
0x14	CDATAL	R	Clear data low byte	0x00
0x15	CDATAH	R	Clear data high byte	0x00
0x16	RDATAH	R	Red data low byte	0x00
0x17	RDATAH	R	Red data high byte	0x00
0x18	GDATAH	R	Green data low byte	0x00
0x19	GDATAH	R	Green data high byte	0x00
0x1A	BDATAH	R	Blue data low byte	0x00
0x1B	BDATAH	R	Blue data high byte	0x00

The mechanics of accessing a specific register depends on the specific protocol used. See the section on I<sup>2</sup>C protocols on the previous pages. In general, the COMMAND register is written first to specify the specific control-status-data register for subsequent read/write operations.

### Command Register

The command register specifies the address of the target register for future write and read operations.

**Figure 25:**  
Command Register

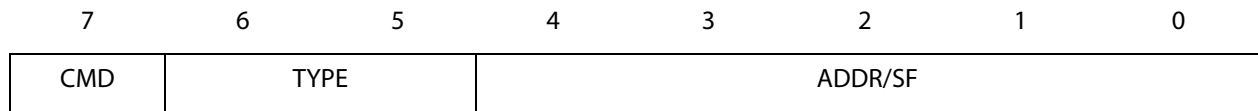

Fields	Bits	Description	
CMD	7	Select Command Register. Must write as 1 when addressing COMMAND register.	
TYPE	6:5	Selects type of transaction to follow in subsequent data transfers:	
		<b>FIELD VALUE</b>	<b>TRANSACTION TYPE</b>
		00	Repeated byte protocol transaction
		01	Auto-increment protocol transaction
		10	Reserved — Do not use
		11	Special function — See description below
		Byte protocol will repeatedly read the same register with each data access. Block protocol will provide auto-increment function to read successive bytes.	
ADDR/SF	4:0	Address field/special function field. Depending on the transaction type, see above, this field either specifies a special function command or selects the specific control-status-data register for subsequent read and write transactions. The field values listed below only apply to special function commands:	
		<b>FIELD VALUE</b>	<b>READ VALUE</b>
		00110	Clear channel interrupt clear
		Other	Reserved — Do not write
		The Clear channel interrupt clear special function clears any pending interrupt and is self-clearing.	

### Enable Register (0x00)

The ENABLE register is used primarily to power the TCS3472 device ON and OFF, and enable functions and interrupts as shown below.

**Figure 26:**  
Enable Register

7	6	5	4	3	2	1	0
Reserved			AIEN	WEN	Reserved	AEN	PON

Fields	Bits	Description
Reserved	7:5	Reserved. Write as 0.
AIEN	4	RGBC interrupt enable. When asserted, permits RGBC interrupts to be generated.
WEN	3	Wait enable. This bit activates the wait feature. Writing a 1 activates the wait timer. Writing a 0 disables the wait timer.
Reserved	2	Reserved. Write as 0.
AEN	1	RGBC enable. This bit activates the two-channel ADC. Writing a 1 activates the RGBC. Writing a 0 disables the RGBC.
PON <sup>(1), (2)</sup>	0	Power ON. This bit activates the internal oscillator to permit the timers and ADC channels to operate. Writing a 1 activates the oscillator. Writing a 0 disables the oscillator.

**Notes:**

1. See Power Management section for more information.
2. A minimum interval of 2.4 ms must pass after PON is asserted before an RGBC can be initiated.

### RGBC Timing Register (0x01)

The RGBC timing register controls the internal integration time of the RGBC clear and IR channel ADCs in 2.4-ms increments. Max RGBC Count = (256 – ATIME) × 1024 up to a maximum of 65535.

**Figure 27:**  
RGBC Timing Register

Fields	Bits	Description			
		VALUE	INTEG_CYCLES	TIME	MAX COUNT
ATIME	7:0	0xFF	1	2.4 ms	1024
		0xF6	10	24 ms	10240
		0xD5	42	101 ms	43008
		0xC0	64	154 ms	65535
		0x00	256	614 ms	65535

### Wait Time Register (0x03)

Wait time is set 2.4 ms increments unless the WLONG bit is asserted, in which case the wait times are 12× longer. WTIME is programmed as a 2's complement number.

**Figure 28:**  
Wait Time Register

Fields	Bits	Description			
		REGISTER VALUE	WAIT TIME	TIME (WLONG= 0)	TIME (WLONG= 1)
WTIME	7:0	0xFF	1	2.4 ms	0.029 sec
		0xAB	85	204 ms	2.45 sec
		0x00	256	614 ms	7.4 sec



### RGBC Interrupt Threshold Registers (0x04 – 0x07)

The RGBC interrupt threshold registers provides the values to be used as the high and low trigger points for the comparison function for interrupt generation. If the value generated by the clear channel crosses below the lower threshold specified, or above the higher threshold, an interrupt is asserted on the interrupt pin.

**Figure 29:**  
RGBC Interrupt Threshold Registers

Register	Address	Bits	Description
AILTL	0x04	7:0	RGBC clear channel low threshold lower byte
AILTH	0x05	7:0	RGBC clear channel low threshold upper byte
AIHTL	0x06	7:0	RGBC clear channel high threshold lower byte
AIHTH	0x07	7:0	RGBC clear channel high threshold upper byte

### Persistence Register (0x0C)

The persistence register controls the filtering interrupt capabilities of the device. Configurable filtering is provided to allow interrupts to be generated after each integration cycle or if the integration has produced a result that is outside of the values specified by the threshold register for some specified amount of time.

**Figure 30:**  
Persistence Register

7	6	5	4	3	2	1	0
Reserved				APERS			

Field	Bits	Description
PPERS	7:4	Reserved

Field	Bits	Description		
APERS	3:0	Interrupt persistence. Controls rate of interrupt to the host processor.		
		FIELD VALUE	MEANING	INTERRUPT PERSISTENCE FUNCTION
		0000	Every	Every RGBC cycle generates an interrupt
		0001	1	1 clear channel value outside of threshold range
		0010	2	2 clear channel consecutive values out of range
		0011	3	3 clear channel consecutive values out of range
		0100	5	5 clear channel consecutive values out of range
		0101	10	10 clear channel consecutive values out of range
		0110	15	15 clear channel consecutive values out of range
		0111	20	20 clear channel consecutive values out of range
		1000	25	25 clear channel consecutive values out of range
		1001	30	30 clear channel consecutive values out of range
		1010	35	35 clear channel consecutive values out of range
		1011	40	40 clear channel consecutive values out of range
		1100	45	45 clear channel consecutive values out of range
		1101	50	50 clear channel consecutive values out of range
		1110	55	55 clear channel consecutive values out of range
1111	60	60 clear channel consecutive values out of range		

### Configuration Register (0x0D)

The configuration register sets the wait long time.

**Figure 31:**  
Configuration Register

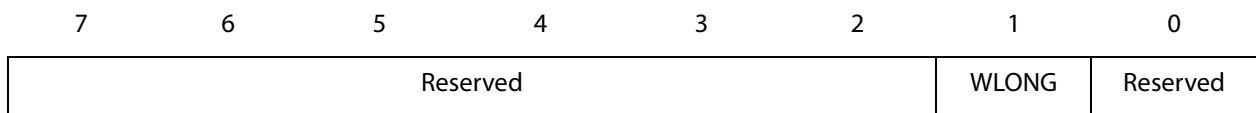

Fields	Bits	Description
Reserved	7:2	Reserved. Write as 0.
WLONG	1	Wait Long. When asserted, the wait cycles are increased by a factor 12× from that programmed in the WTIME register.
Reserved	0	Reserved. Write as 0.

### Control Register (0x0F)

The Control register provides eight bits of miscellaneous control to the analog block. These bits typically control functions such as gain settings and/or diode selection.

**Figure 32:**  
Control Register

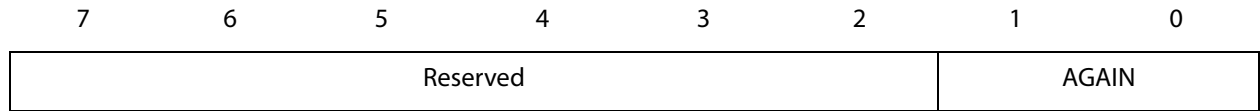

Fields	Bits	Description	
Reserved	7:2	Reserved. Write as 0.	
AGAIN	1:0	RGBC Gain Control.	
		<b>FIELD VALUE</b>	<b>RGBC GAIN VALUE</b>
		00	1x gain
		01	4x gain
		10	16x gain
		11	60x gain

### ID Register (0x12)

The ID Register provides the value for the part number. The ID register is a read-only register.

**Figure 33:**  
ID Register

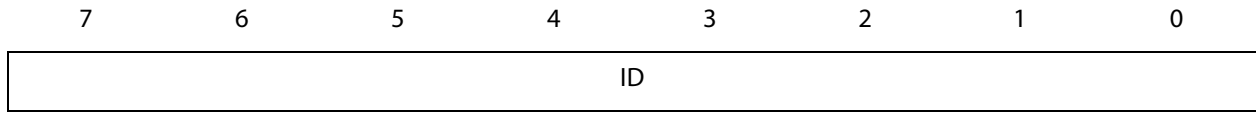

Field	Bits	Description	
ID	7:0	Part number identification	0x44 = TCS34725
			0x4D = TCS34727

### Status Register (0x13)

The Status Register provides the internal status of the device. This register is read only.

**Figure 34:**  
Status Register

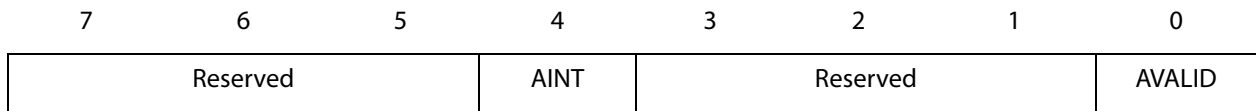

Field	Bits	Description
Reserved	7:5	Reserved.
AINT	4	RGBC clear channel Interrupt.
Reserved	3:1	Reserved.
AVALID	0	RGBC Valid. Indicates that the RGBC channels have completed an integration cycle.

### RGBC Channel Data Registers (0x14 – 0x1B)

Clear, red, green, and blue data is stored as 16-bit values. To ensure the data is read correctly, a two-byte read I<sup>2</sup>C transaction should be used with a read word protocol bit set in the command register. With this operation, when the lower byte register is read, the upper eight bits are stored into a shadow register, which is read by a subsequent read to the upper byte. The upper register will read the correct value even if additional ADC integration cycles end between the reading of the lower and upper registers.

**Figure 35:**  
RGBC Channel Data Registers

Register	Address	Bits	Description
CDATA	0x14	7:0	Clear data low byte
CDATAH	0x15	7:0	Clear data high byte
RDATA	0x16	7:0	Red data low byte
RDATAH	0x17	7:0	Red data high byte
GDATA	0x18	7:0	Green data low byte
GDATAH	0x19	7:0	Green data high byte
BDATA	0x1A	7:0	Blue data low byte
BDATAH	0x1B	7:0	Blue data high byte

## Application Information: Hardware

### PCB Pad Layout

Suggested PCB pad layout guidelines for the Dual Flat No-Lead (FN) surface mount package are shown in [Figure 36](#).

**Figure 36:**  
Suggested FN Package PCB Layout

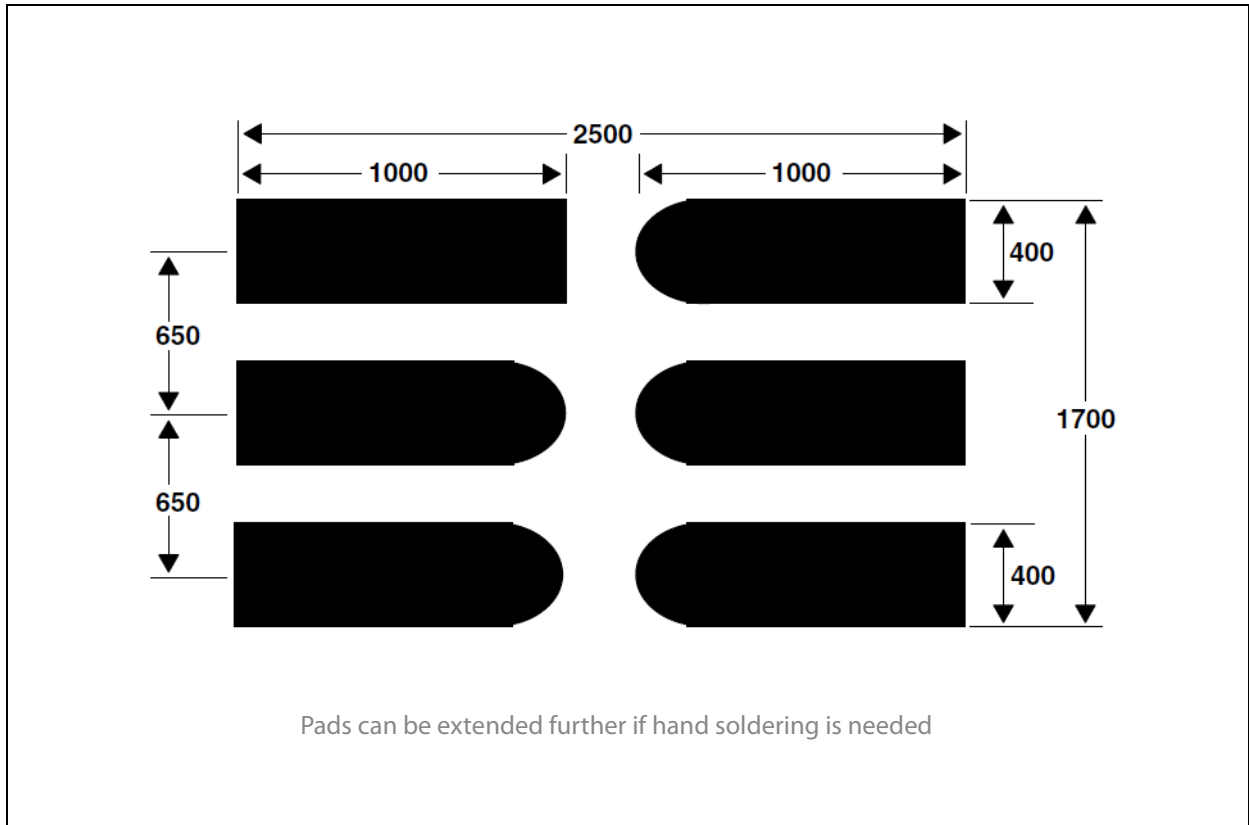

**Notes:**

1. All linear dimensions are in micrometers.
2. This drawing is subject to change without notice.

### Package Drawings & Markings

Figure 37:  
Package FN – Dual Flat No-Lead Packaging Configuration

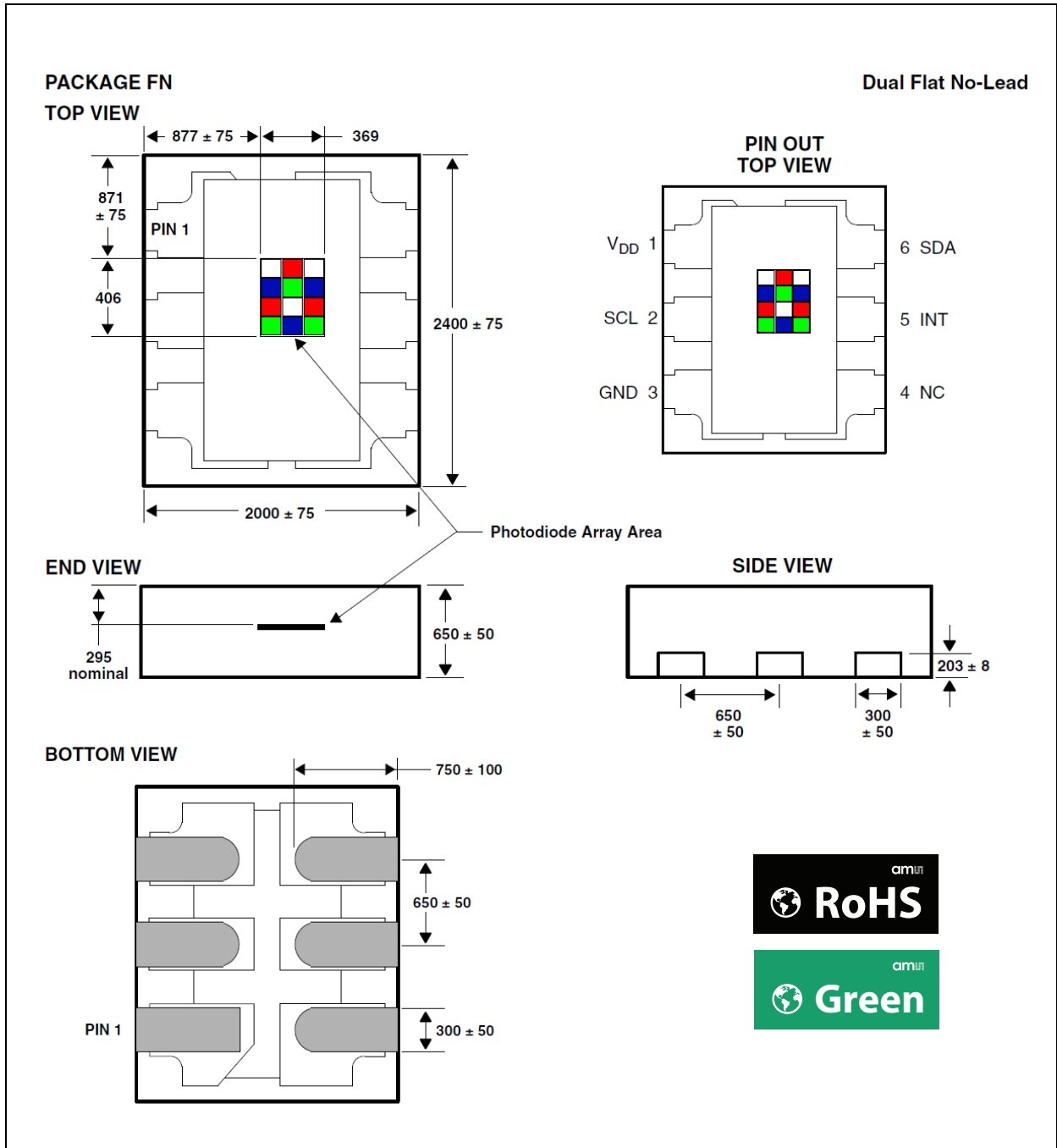

**Notes:**

1. All linear dimensions are in micrometers. Dimension tolerance is  $\pm 20 \mu\text{m}$  unless otherwise noted.
2. The die is centered within the package within a tolerance of  $\pm 3$  mils.
3. Package top surface is molded with an electrically nonconductive clear plastic compound having an index of refraction of 1.55.
4. Contact finish is copper alloy A194 with pre-plated NiPdAu lead finish.
5. This package contains no lead (Pb).
6. This drawing is subject to change without notice.

## Mechanical Data

**Figure 38:**  
Carrier Tape and Reel Information

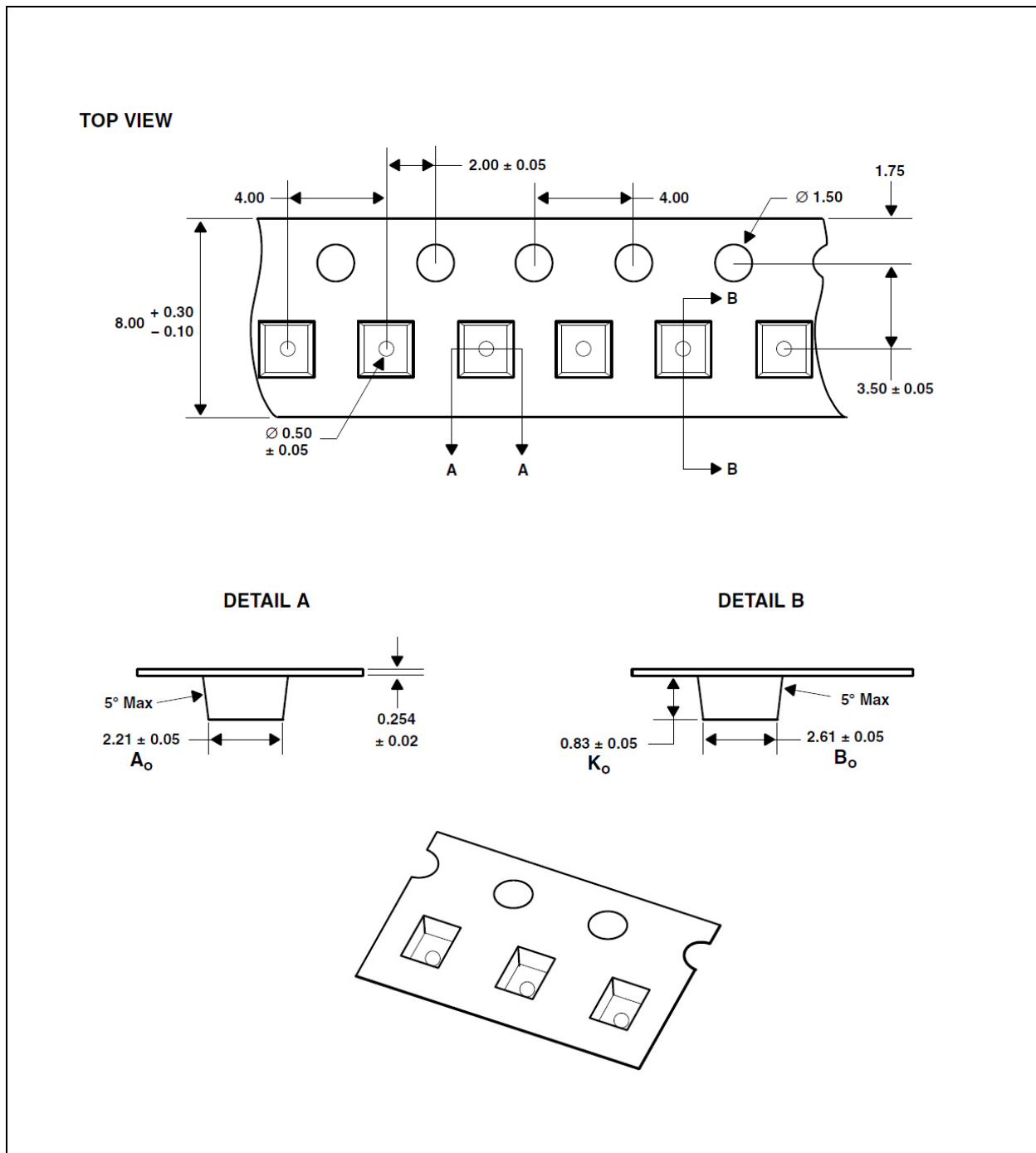

**Notes:**

1. All linear dimensions are in millimeters. Dimension tolerance is  $\pm 0.10$  mm unless otherwise noted.
2. The dimensions on this drawing are for illustrative purposes only. Dimensions of an actual carrier may vary slightly.
3. Symbols on drawing  $A_0$ ,  $B_0$ , and  $K_0$  are defined in ANSI EIA Standard 481-B 2001.
4. Each reel is 178 millimeters in diameter and contains 3500 parts.
5. **ams** packaging tape and reel conform to the requirements of EIA Standard 481-B.
6. In accordance with EIA standard, device pin 1 is located next to sprocket holes in the tape.
7. This drawing is subject to change without notice.



## Soldering & Storage Information

### Soldering Information

The FN package has been tested and has demonstrated an ability to be reflow soldered to a PCB substrate. The process, equipment, and materials used in these test are detailed below.

The solder reflow profile describes the expected maximum heat exposure of components during the solder reflow process of product on a PCB. Temperature is measured on top of component. The components should be limited to a maximum of three passes through this solder reflow profile.

**Figure 39:**  
Solder Reflow Profile

Parameter	Reference	Device
Average temperature gradient in preheating		2.5°C/s
Soak time	$t_{soak}$	2 to 3 minutes
Time above 217°C ( $T_1$ )	$t_1$	Max 60 s
Time above 230°C ( $T_2$ )	$t_2$	Max 50 s
Time above $T_{peak} - 10^\circ\text{C}$ ( $T_3$ )	$t_3$	Max 10 s
Peak temperature in reflow	$T_{peak}$	260°C
Temperature gradient in cooling		Max -5°C/s

**Figure 40:**  
Solder Reflow Profile Graph

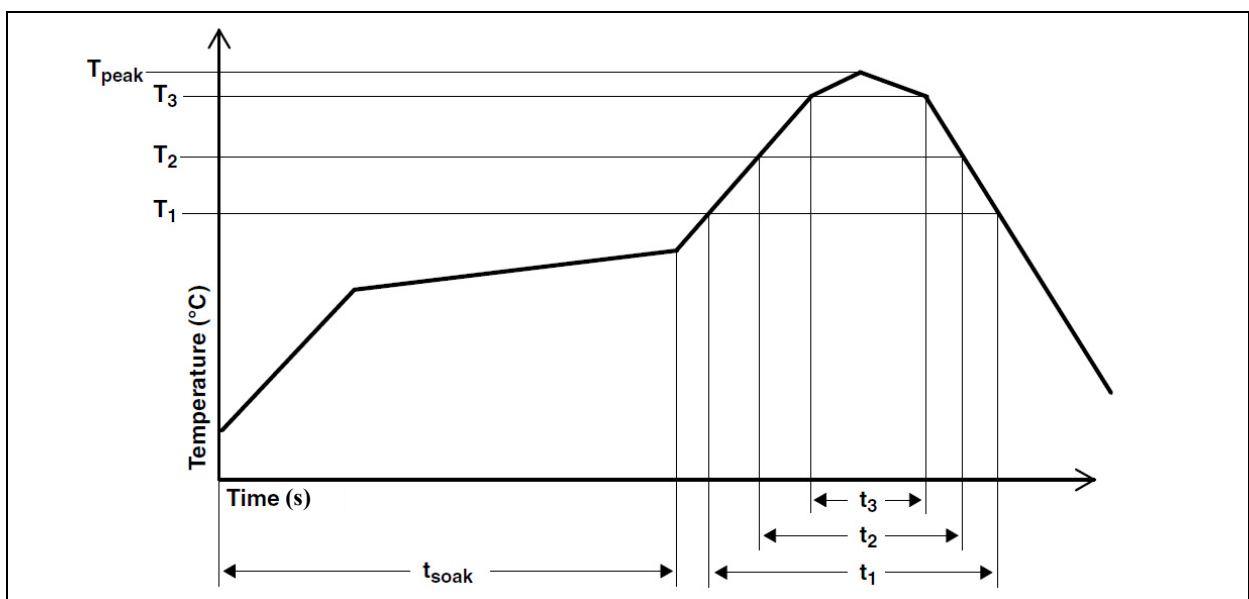

**Note(s):**

1. Not to scale – for reference only.

## Storage Information

### ***Moisture Sensitivity***

Optical characteristics of the device can be adversely affected during the soldering process by the release and vaporization of moisture that has been previously absorbed into the package. To ensure the package contains the smallest amount of absorbed moisture possible, each device is dry-baked prior to being packed for shipping. Devices are packed in a sealed aluminized envelope called a moisture barrier bag with silica gel to protect them from ambient moisture during shipping, handling, and storage before use.

The Moisture Barrier Bags should be stored under the following conditions:

- Temperature Range < 40°C
- Relative Humidity < 90%
- Total Time - No longer than 12 months from the date code on the aluminized envelope if unopened.

Rebaking of the reel will be required if the devices have been stored unopened for more than 12 months and the Humidity Indicator Card shows the parts to be out of the allowable moisture region.

Opened reels should be used within 168 hours if exposed to the following conditions:

- Temperature Range < 30°C
- Relative Humidity < 60%

If rebaking is required, it should be done at 50°C for 12 hours.

The FN package has been assigned a moisture sensitivity level of MSL 3.

## Ordering & Contact Information

Figure 41:  
Ordering Information

Device	Address	Package-Leads	Interface Description	Ordering Number
TCS34725	0x29	FN-6	I <sup>2</sup> C V <sub>BUS</sub> = V <sub>DD</sub> Interface	TCS34725FN
TCS34727	0x29	FN-6	I <sup>2</sup> C V <sub>BUS</sub> = 1.8 V Interface	TCS34727FN

Buy our products or get free samples online at:

[www.ams.com/Products](http://www.ams.com/Products)

Technical Support is available at:

[www.ams.com/Technical-Support](http://www.ams.com/Technical-Support)

Provide feedback about this document at:

[www.ams.com/Document-Feedback](http://www.ams.com/Document-Feedback)

For further information and requests, e-mail us at:

[ams\\_sales@ams.com](mailto:ams_sales@ams.com)

For sales offices, distributors and representatives, please visit:

[www.ams.com/Contact](http://www.ams.com/Contact)

### Headquarters

ams AG  
Tobelbader Strasse 30  
8141 Premstaetten  
Austria, Europe

Tel: +43 (0) 3136 500 0

Website: [www.ams.com](http://www.ams.com)

## RoHS Compliant & ams Green Statement

**RoHS:** The term RoHS compliant means that ams AG products fully comply with current RoHS directives. Our semiconductor products do not contain any chemicals for all 6 substance categories plus additional 4 substance categories (per amendment EU 2015/863), including the requirement that lead not exceed 0.1% by weight in homogeneous materials. Where designed to be soldered at high temperatures, RoHS compliant products are suitable for use in specified lead-free processes.

**ams Green (RoHS compliant and no Sb/Br/Cl):** ams Green defines that in addition to RoHS compliance, our products are free of Bromine (Br) and Antimony (Sb) based flame retardants (Br or Sb do not exceed 0.1% by weight in homogeneous material) and do not contain Chlorine (Cl not exceed 0.1% by weight in homogeneous material).

**Important Information:** The information provided in this statement represents ams AG knowledge and belief as of the date that it is provided. ams AG bases its knowledge and belief on information provided by third parties, and makes no representation or warranty as to the accuracy of such information. Efforts are underway to better integrate information from third parties. ams AG has taken and continues to take reasonable steps to provide representative and accurate information but may not have conducted destructive testing or chemical analysis on incoming materials and chemicals. ams AG and ams AG suppliers consider certain information to be proprietary, and thus CAS numbers and other limited information may not be available for release.

## Copyrights & Disclaimer

Copyright ams AG, Tobelbader Strasse 30, 8141 Premstaetten, Austria-Europe. Trademarks Registered. All rights reserved. The material herein may not be reproduced, adapted, merged, translated, stored, or used without the prior written consent of the copyright owner.

Devices sold by ams AG are covered by the warranty and patent indemnification provisions appearing in its General Terms of Trade. ams AG makes no warranty, express, statutory, implied, or by description regarding the information set forth herein. ams AG reserves the right to change specifications and prices at any time and without notice. Therefore, prior to designing this product into a system, it is necessary to check with ams AG for current information. This product is intended for use in commercial applications. Applications requiring extended temperature range, unusual environmental requirements, or high reliability applications, such as military, medical life-support or life-sustaining equipment are specifically not recommended without additional processing by ams AG for each application. This product is provided by ams AG "AS IS" and any express or implied warranties, including, but not limited to the implied warranties of merchantability and fitness for a particular purpose are disclaimed.

ams AG shall not be liable to recipient or any third party for any damages, including but not limited to personal injury, property damage, loss of profits, loss of use, interruption of business or indirect, special, incidental or consequential damages, of any kind, in connection with or arising out of the furnishing, performance or use of the technical data herein. No obligation or liability to recipient or any third party shall arise or flow out of ams AG rendering of technical or other services.

## Document Status

Document Status	Product Status	Definition
Product Preview	Pre-Development	Information in this datasheet is based on product ideas in the planning phase of development. All specifications are design goals without any warranty and are subject to change without notice
Preliminary Datasheet	Pre-Production	Information in this datasheet is based on products in the design, validation or qualification phase of development. The performance and parameters shown in this document are preliminary without any warranty and are subject to change without notice
Datasheet	Production	Information in this datasheet is based on products in ramp-up to full production or full production which conform to specifications in accordance with the terms of ams AG standard warranty as given in the General Terms of Trade
Datasheet (discontinued)	Discontinued	Information in this datasheet is based on products which conform to specifications in accordance with the terms of ams AG standard warranty as given in the General Terms of Trade, but these products have been superseded and should not be used for new designs

## Revision Information

Changes from 1-03 (2018-Mar-14) to current revision 1-04 (2020-Apr-10)	Page
Updated RGBC Timing Register	23

**Note(s):**

1. Page and figure numbers for the previous version may differ from page and figure numbers in the current revision.
2. Correction of typographical errors is not explicitly mentioned.

## Content Guide

<b>1</b>	<b>General Description</b>
1	Key Benefits & Features
2	Applications
2	End Products and Market Segments
3	Block Diagram
<b>4</b>	<b>Detailed Description</b>
<b>5</b>	<b>Pin Assignment</b>
<b>6</b>	<b>Absolute Maximum Ratings</b>
<b>7</b>	<b>Electrical Characteristics</b>
<b>10</b>	<b>Timing Characteristics</b>
10	Timing Diagram
<b>11</b>	<b>Typical Operating Characteristics</b>
<b>13</b>	<b>Principles of Operation</b>
13	System States
14	RGBC Operation
15	Interrupts
17	System Timing
18	Power Management
<b>19</b>	<b>I<sup>2</sup>C Protocol</b>
<b>20</b>	<b>Register Description</b>
21	Command Register
22	Enable Register (0x00)
23	RGBC Timing Register (0x01)
23	Wait Time Register (0x03)
24	RGBC Interrupt Threshold Registers (0x04 – 0x07)
24	Persistence Register (0x0C)
25	Configuration Register (0x0D)
26	Control Register (0x0F)
27	ID Register (0x12)
27	Status Register (0x13)
28	RGBC Channel Data Registers (0x14 – 0x1B)
<b>29</b>	<b>Application Information: Hardware</b>
29	PCB Pad Layout
<b>30</b>	<b>Package Drawings &amp; Markings</b>
<b>31</b>	<b>Mechanical Data</b>
<b>32</b>	<b>Soldering &amp; Storage Information</b>
32	Soldering Information
33	Storage Information
33	Moisture Sensitivity



- 34 Ordering Information**
- 35 RoHS Compliant & ams Green Statement**
- 36 Copyrights & Disclaimer**
- 37 Document Status**
- 38 Revision Information**