

Kxxxzy SIDAC

RoHS

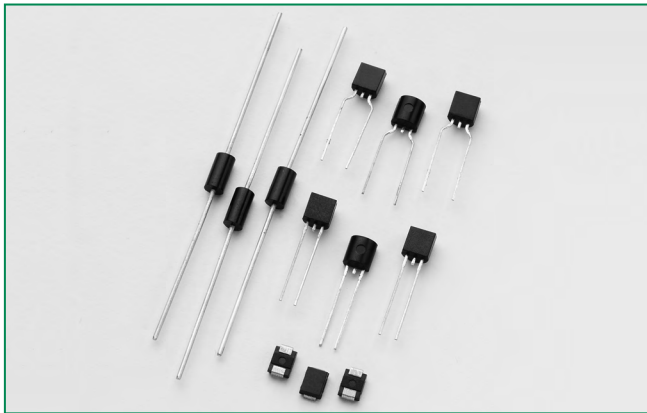

Description

The SIDAC is a silicon bilateral voltage triggered switch. Upon application of a voltage exceeding the SIDAC breakover voltage point, the SIDAC switches on through a negative resistance region to a low on-state voltage. Conduction continues until the current is interrupted or drops below the minimum holding current of the device.

SIDACs feature glass-passivated junctions to ensure a rugged and dependable device capable of withstanding harsh environments.

Features

- AC Circuit Oriented
- RoHS Compliant
- Triggering Voltage of 79V to 330V

Applications

Suitable for high voltage power supplies, natural gas igniters, high-pressure Sodium lamps, and Xenon flash ignition.

Schematic Symbol

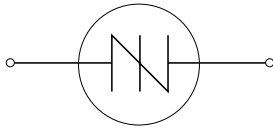

Electrical Specifications (T_j = 25°C, unless otherwise specified)

Symbol	Parameters	Test Conditions	Min	Max	Unit
V _{BO}	Breakover/Trigger Voltage	K0900y	79	97	V
		K1050y	95	113	
		K1100y	104	118	
		K1200y	110	125	
		K1300y	120	138	
		K1400y	130	146	
		K1500y	140	170	
		K1800y	165	195	
		K200zy	190	215	
		K220zy	205	230	
		K230zy	220	240	
		K240zy	220	250	
		K250zy	240	280	
K300zy	270	330			
V _{DRM}	Repetitive Peak Off-state Voltage	K0900y	70		V
		K1050y	90		
		K1100y	90		
		K1200y	90		
		K1300y	90		
		K1400y	90		
		K1500y	90		
		K1800y	140		
		K200zy	180		
		K220zy	180		
		K230zy	190		
		K240zy	190		
		K250zy	200		
K300zy	200				

Note: xxx = voltage, z = circuit function, y = package

Electrical Specifications ($T_J = 25^\circ\text{C}$, unless otherwise specified)

Symbol	Parameters	Test Conditions	Min	Max	Unit
$I_{T(RMS)}$	On-state RMS Current	50/60Hz, $T_J < 125^\circ\text{C}$		1	A
I_{DRM}	Repetitive Peak Off-state Current	$V = V_{DRM}$ 50/60Hz Sine Wave		5	μA
V_{TM}	Peak On-state Voltage	$I_T = 1\text{A}$ Kxxx0y Kxxx2y		1.5 3.0	V
I_H	Dynamic Holding Current	$R_L = 100\Omega$ 50/60Hz Sine Wave		150	mA
R_S	Switching Resistance, $R_S = \frac{(V_{BO} - V_S)}{(I_S - I_{BO})}$	50/60Hz Sine Wave	100		Ω
I_{BO}	Breakover Current	50/60Hz Sine Wave		10	μA
I_{TRM}	Peak Repetitive Pulse Current (refer to figure 4)	$t_p = 10\mu\text{s}$ 60Hz 5Hz		80 160	A
I_{TSM}	Peak Non-repetitive Surge Current (refer to figure 5)	Single Cycle 60Hz 50Hz		20 16.7	A
di/dt	Critical Rate of Rise of On-state Current			150	A/ μs
dv/dt	Critical Rate of Rise of Off-state Voltage		1500		V/ μs
T_S	Storage Temperature Range		-40	150	$^\circ\text{C}$
T_J	Junction Temperature Range		-40	125	$^\circ\text{C}$
R_{JL}	Thermal Resistance, Junction to Lead	DO-15 DO-214 (1)		18 30	$^\circ\text{C/W}$
$R_{\theta JC}$	Thermal Resistance, Junction to Case	TO-92		35	$^\circ\text{C/W}$
$R_{\theta JA}$	Thermal Resistance, Junction to Ambient	DO-15 TO-92		75 95	$^\circ\text{C/W}$

Notes: xxx = voltage, z = circuit function, y = package
(1) Mounted on 1 cm² copper foil surface; two-ounce copper foil

Additional Information



Datasheet



Resources



Samples

Figure 1: V-I Characteristics



Figure 2: On-state Current vs. On-state Voltage (Typical)



Figure 3: Power Dissipation vs. On-state Current (Typical)



Figure 4: Repetitive Peak On-state Current (I_TRM) vs. Pulse Width at Various Frequencies



Figure 5: Peak Non-repetitive Surge Current (I_TSM) vs. Number of Cycles

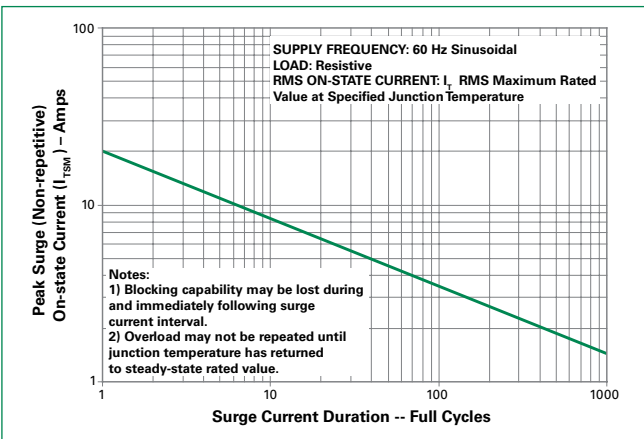

Figure 6: Normalized V_BO Change vs. Junction Temperature

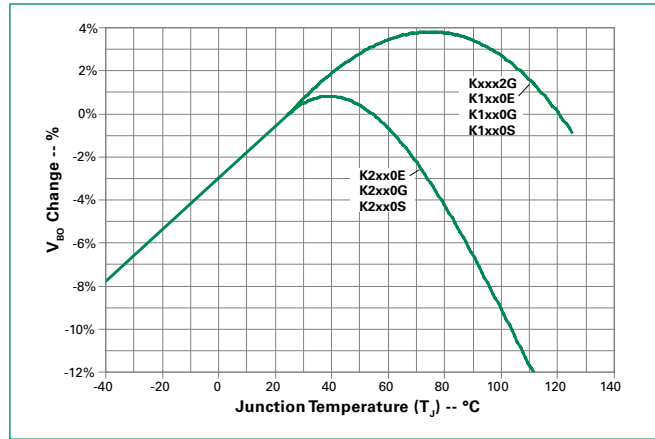

Figure 7: Normalized DC Holding Current vs. Junction Temperature

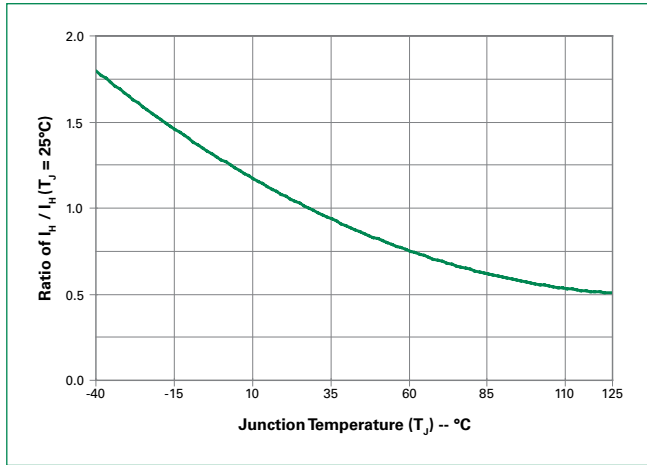

Figure 8: Maximum Allowable Case Temperature vs. RMS On-State Current



Figure 9: Maximum Allowable Ambient Temperature vs. RMS On-State Current

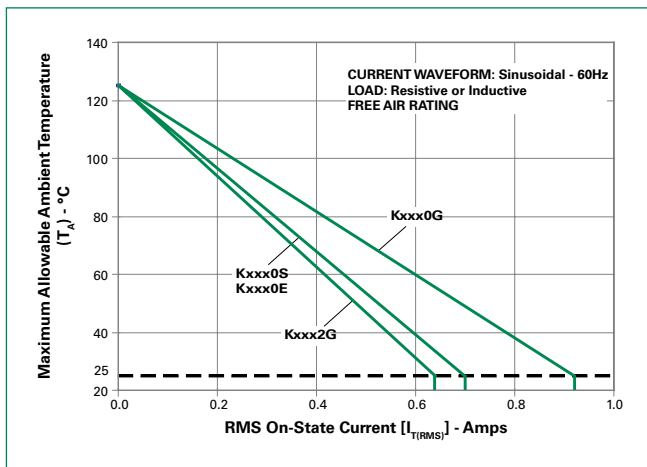

Figure 10: Normalized Repetitive Peak Breakover Current (I_{BO}) vs. Junction Temperature



Figure 11: Dynamic Holding Current Test Circuit for SIDACs



Figure 12: Basic SIDAC Circuit



Figure 13: Relaxation Oscillator Using a SIDAC



Figure 14: Low-voltage Input Circuit for Gas Ignition



Figure 15: Comparison of SIDAC versus SCR for Gas Ignitor Circuit



Figure 16: Xenon Lamp Flashing Circuit



Figure 17: Typical High-pressure Sodium Lamp Firing Circuit



Soldering Parameters

Reflow Condition		Pb – Free assembly
Pre Heat	- Temperature Min ($T_{s(min)}$)	150°C
	- Temperature Max ($T_{s(max)}$)	200°C
	- Time (min to max) (t_s)	60 – 180 secs
Average ramp up rate (Liquidus Temp) (T_L) to peak		5°C/second max
$T_{s(max)}$ to T_L - Ramp-up Rate		5°C/second max
Reflow	- Temperature (T_L) (Liquidus)	217°C
	- Temperature (t_L)	60 – 150 seconds
Peak Temperature (T_p)		260 ^{+0/-5} °C
Time within 5°C of actual peak Temperature (t_p)		20 – 40 seconds
Ramp-down Rate		5°C/second max
Time 25°C to peak Temperature (T_p)		8 minutes Max.
Do not exceed		280°C



Physical Specifications

Terminal Finish	100% Matte Tin Plated / Pb-free Solder Dipped
Body Material	UL recognized epoxy meeting flammability classification 94V-0
Lead Material	Copper Alloy

Design Considerations

Careful selection of the correct device for the application's operating parameters and environment will go a long way toward extending the operating life of the Thyristor. Overheating and surge currents are the main killers of SIDACs. Correct mounting, soldering, and forming of the leads also help protect against component damage.

Reliability/Environmental Tests

Test	Specifications and Conditions
High Temperature Voltage Blocking	MIL-STD-750: Method 1040, Condition A Rated V_{DRM} (VAC-peak), 125°C, 1008 hours
Temperature Cycling	MIL-STD-750: Method 1051 -40°C to 150°C, 15-minute dwell, 100 cycles
Biased Temperature & Humidity	EIA/JEDEC: JESD22-A101 80% min V_{BO} (V_{DC}), 85°C, 85% RH, 1008 hours
High Temp Storage	MIL-STD-750: Method 1031 150°C, 1008 hours
Low-Temp Storage	-40°C, 1008 hours
Thermal Shock	MIL-STD-750: Method 1056 0°C to 100°C, 5-minute dwell, 10-second transfer, 10 cycles
Autoclave (Pressure Cooker Test)	EIA/JEDEC: JESD22-A102 121°C, 100% RH, 2atm, 168 hours
Resistance to Solder Heat	MIL-STD-750: Method 2031 260°C, 10 seconds
Solderability	ANSI/J-STD-002: Category 3
Lead Bend	MIL-STD-750: Method 2036, Condition E

Dimensions — DO-214



Dimension	Inches		Millimeters	
	Max	Max	Min	Max
A	0.130	0.156	3.30	3.95
B	0.201	0.220	5.10	5.60
C	0.077	0.087	1.95	2.20
D	0.159	0.181	4.05	4.60
E	0.030	0.063	0.75	1.60
F	0.075	0.096	1.90	2.45
G	0.002	0.008	0.05	0.20
H	0.077	0.104	1.95	2.65
K	0.006	0.016	0.15	0.41

Dimensions — DO-15

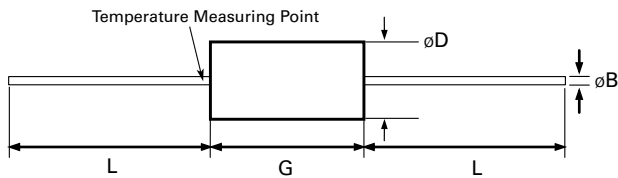

Dimension	Inches		Millimeters	
	Max	Max	Min	Max
ϕB	0.028	0.034	0.711	0.864
ϕD	0.120	0.140	3.048	3.556
G	0.235	0.270	5.969	6.858
L	1.000		25.400	

Dimensions — TO-92 with Type 70 Lead Form



Dimension	Inches		Millimeters	
	Max	Max	Min	Max
A	0.176	0.196	4.47	4.98
B	0.500		12.70	
D	0.095	0.105	2.41	2.67
E	0.150		3.81	
F	0.046	0.054	1.16	1.37
G	0.135	0.145	3.43	3.68
H	0.088	0.096	2.23	2.44
J	0.176	0.186	4.47	4.73
K	0.088	0.096	2.23	2.44
L	0.013	0.019	0.33	0.48
M	0.013	0.017	0.33	0.43
N		0.060		1.52

Notes:

1. Type 70 lead form as shown is standard for the E package.
2. All leads are insulated from case. Case is electrically nonconductive (rated at 16000V ac rms for one minute from leads to case over the operating temperature range.)
3. Mold flash shall not exceed 0.13 mm per side.

Product Selector

Part Number	Switching Voltage Range		Blocking Voltage	Packages		
	V _{BO} Minimum	V _{BO} Maximum	V _{DRM}	DO-15	DO-214	TO-92
K0900y	79V	97V	70V	K0900G	K0900S	K0900E70
K1050y	95V	113V	90V	K1050G	K1050S	K1050E70
K1100y	104V	118V	90V	K1100G	K1100S	K1100E70
K1200y	110V	125V	90V	K1200G	K1200S	K1200E70
K1300y	120V	138V	90V	K1300G	K1300S	K1300E70
K1400y	130V	146V	90V	K1400G	K1400S	K1400E70
K1500y	140V	170V	90V	K1500G	K1500S	K1500E70
K1800y	165V	195V	140V		K1800S	
K2000y	190V	215V	180V	K2000G	K2000S	K2000E70
K2002y	190V	215V	180V	K2002G		
K2200y	205V	230V	180V	K2200G	K2200S	K2200E70
K2202y	205V	230V	180V	K2202G		
K2300y	220V	240V	190V	K2300G	K2300S	K2300E70
K2400y	220V	250V	190V	K2400G	K2400S	K2400E70
K2402y	220V	250V	190V	K2402G		
K2500y	240V	280V	200V	K2500G	K2500S	K2500E70
K2502y	240V	280V	200V	K2502G		
K3002y	270V	330V	200V	K3002G		

Note: y = package

Packing Options

Part Number	Marking	Weight	Packaging Mode	Base Quantity
Kxxx0G	Kxxx0G	0.38g	Bulk	1000
Kxxx0GRP	Kxxx0G	0.38g	Reel Pack	5000
Kxxx2G	Kxxx2G	0.38g	Bulk	1000
Kxxx2GRP	Kxxx2G	0.38g	Reel Pack	5000
Kxxx0SRP	KxxS	0.1g	Reel Pack	2500
Kxxx0E70	Kxxx0E	0.17g	Bulk	2000
Kxxx0E70AP	Kxxx0E	0.17g	Ammo Pack	2000
Kxxx0E70RP2	Kxxx0E	0.17g	Reel Pack	2000
Kxxx0E70RP3	Kxxx0E	0.17g	Reel Pack	2000

Note: xxx or xx = voltage

DO-214 Embossed Carrier Reel Pack (RP) Specifications



DO-15 Reel Pack (RP) Specifications



DO-15 Ammo Pack (AP) Specifications



TO-92 Type 70 Reel Pack (RP3) Radial Leaded Specifications



TO-92 Type 70 Reel Pack (RP2) Radial Leaded Specifications

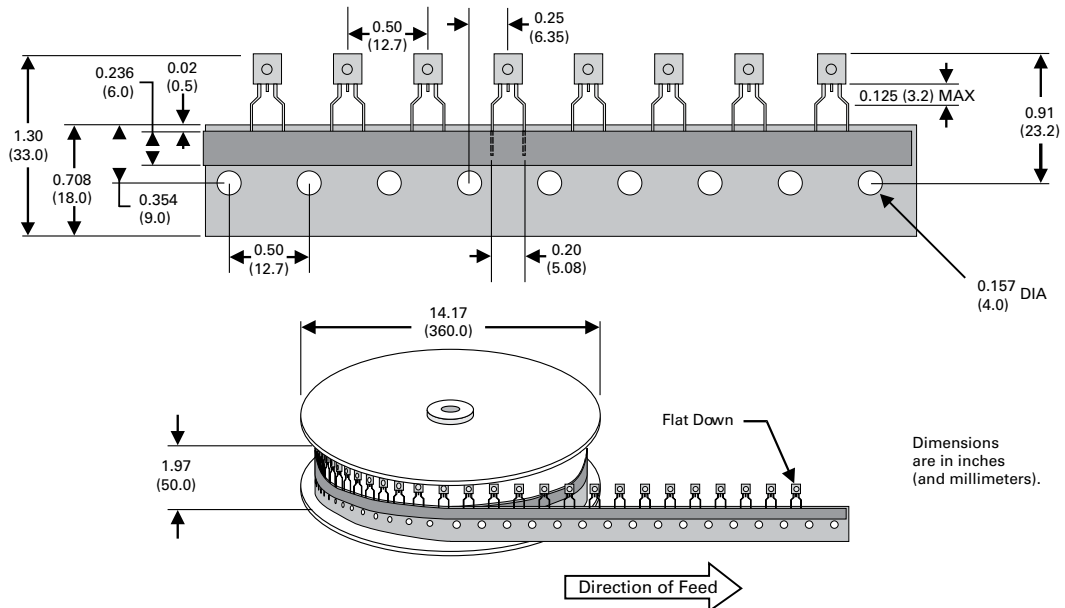

TO-92 Type 70 Ammo Pack (AP) Radial Leaded Specifications



Part Numbering System

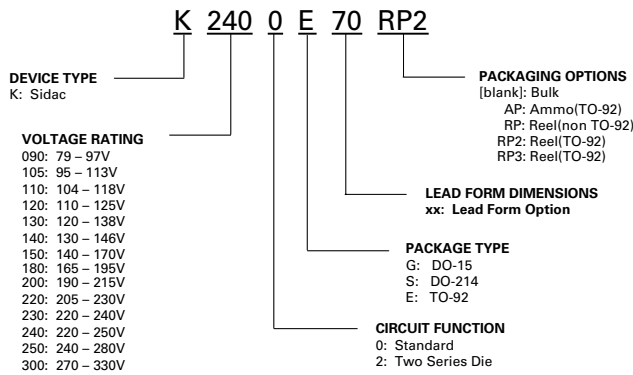

Part Marking System

