

NOTES:

1. ALL PARTS TO BE BULK PACKED UNLESS NOTED.
2. INSTA CLICK IN LINE CABLE ASSEMBLY IS SUPPLIED AS A KIT. CONTACTS SUPPLIED UNASSEMBLED FOR CRIMP AND ASSEMBLED FOR SOCKET VERSIONS
3. ALL DIMENSIONS ARE REFERENCED IN INCHES [MM], WITHIN ± 0.015 UNLESS NOTED.
4. SIZE #20, 9 POSITION CRIMP CONTACTS ASSEMBLY IS BEEN SHOWN AS EXAMPLE. VISIT PART NUMBERING SYSTEM AHART TO VISIT VARIOUS SELECTIONS

PART NUMBER SYSTEM

W 5 X 8 X - X PG -P- 5 XX

CONTACT SIZES

- 1' - SIZE #12
- 2' - SIZE #20
- 3' - SIZE #16

CONTACTS STYLE

- 0' - CRIMP
- 2' - SOLDER

CONTACT POSITIONS

- POSITION 2, 3 & 4 (AVAILABLE IN SIZE #12)
- POSITION 4, 5 & 6 (AVAILABLE IN SIZE #16)
- POSITION 4,5,6,7,8,9,10,11&12 (AVAILABLE IN SIZE #20)

- 15 - CABLE OD 0.15 - 0.17 [3.8 - 4.3mm]
- 18 - CABLE OD 0.18 - 0.20 [4.6 - 5.1mm]
- 21 - CABLE OD 0.21 - 0.23 [5.3 - 5.8mm]
- 24 - CABLE OD 0.24 - 0.27 [6.1 - 6.8mm]
- 28 - CABLE OD 0.28 - 0.29 [7.1 - 7.4mm]
- 30 - CABLE OD 0.30 - 0.32 [7.6 - 8.1mm]
- 35 - CABLE OD 0.35 - 0.40 [8.9 - 10.2mm]

(2) #4 X 3/8 PAN HEAD SELF TAPPING SCREW  
MATL: STAINLESS STEEL

CABLE STRAP  
MATL: VALOX, BLACK

BACKSHELL  
MATL: THERMOPLASTIC, BLACK

SLEEVE  
MATL: THERMOPLASTIC, BLACK

GROMMET

MATL: SANTOPRENE, BLACK

- W5280-XPG-P-515 0.156 ID FOR CABLES 0.15 - 0.17 [3.5 - 4.3mm]OD
- W5280-XPG-P-518 0.187 ID FOR CABLES 0.18 - 0.20 [4.6 - 5.1mm]OD
- W5280-XPG-P-521 0.225 ID FOR CABLES 0.21 - 0.23 [5.3 - 5.8mm]OD
- W5280-XPG-P-524 0.250 ID FOR CABLES 0.24 - 0.27 [6.1 - 6.8mm]OD
- W5280-XPG-P-528 0.285 ID FOR CABLES 0.28 - 0.29 [7.1 - 7.4mm]OD
- W5280-XPG-P-530 0.312 ID FOR CABLES 0.30 - 0.32 [7.6 - 8.1mm]OD
- W5280-XPG-P-535 0.375 ID FOR CABLES 0.35 - 0.340 [7.6 - 8.1mm]OD

#20 CRIMP CONTACTS SHOWN HERE  
MATL: COPPER ALLOY, GOLD PLATED

IN LINE CABLE CONN, MALE  
MATL: THERMOPLASTIC, BLACK

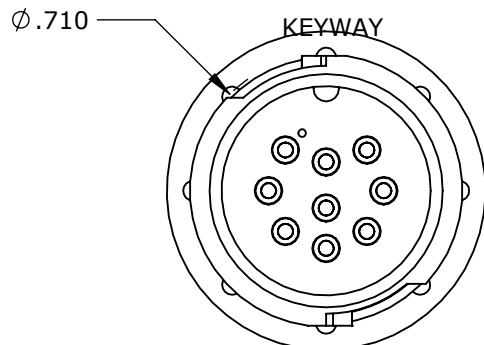

W5280-9PG-P-5XX SHOWN MATING VIEW

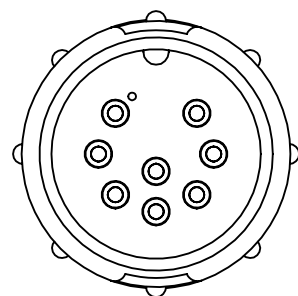
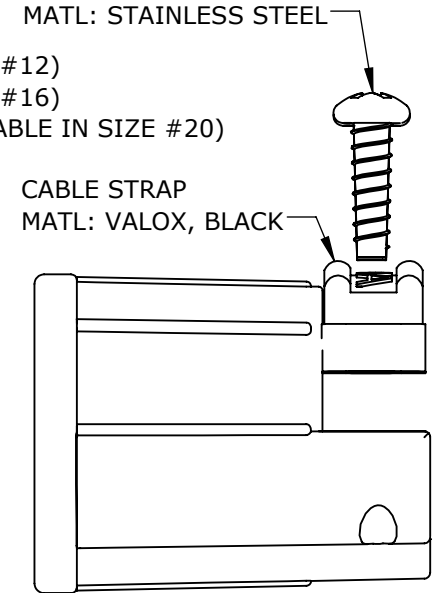
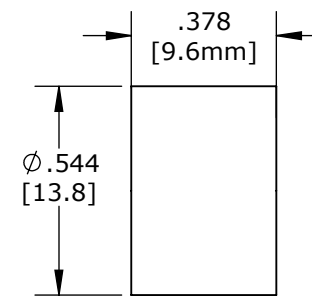
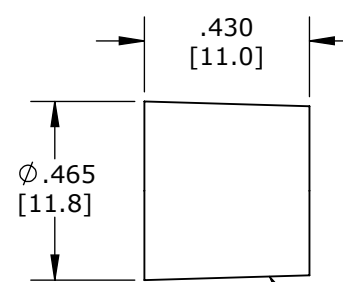
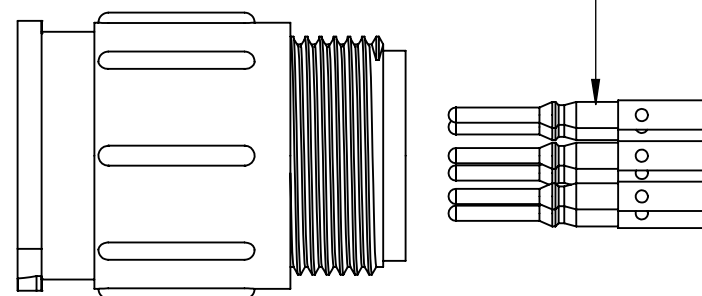

W5280-8PG-P-5XX MATING VIEW

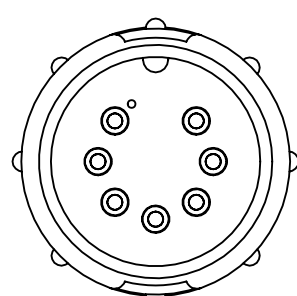

W5280-7PG-P-5XX MATING VIEW

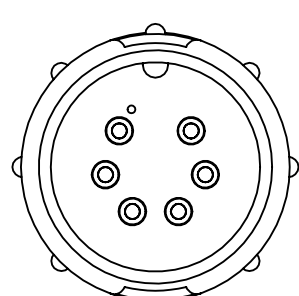

W5280-6PG-P-5XX MATING VIEW

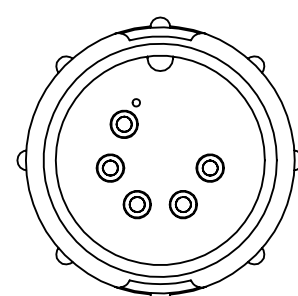

W5280-5PG-P-5XX MATING VIEW

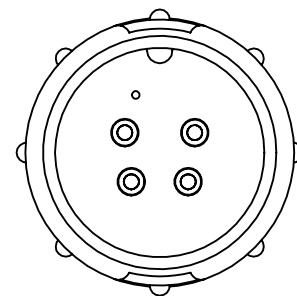

W5280-4PG-P-5XX MATING VIEW

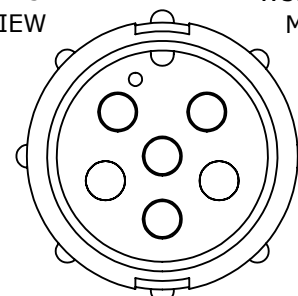

W5380-6PG-P-5XX MATING VIEW

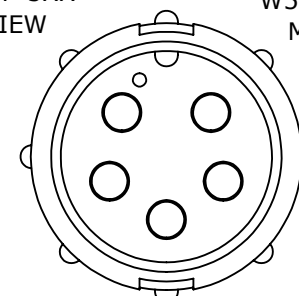

W5380-5PG-P-5XX MATING VIEW

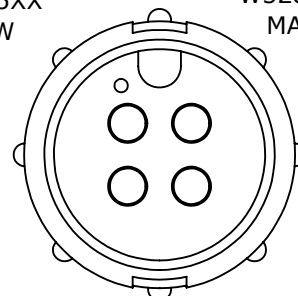

W5380-4PG-P-5XX MATING VIEW

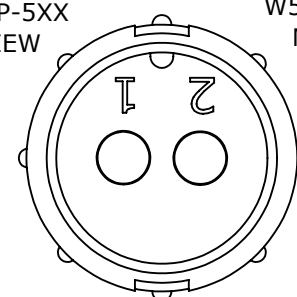

W5180-2PG-P-5XX MATING VIEW

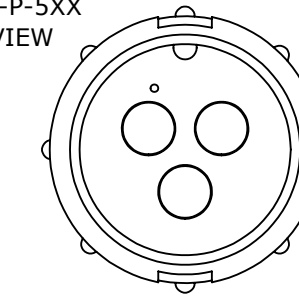

W5180-3PG-P-5XX MATING VIEW

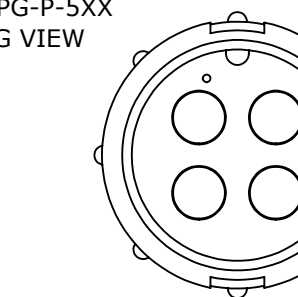

W5180-4PG-P-5XX MATING VIEW

CUSTOMER PRINT

PART NUMBER: W5X8X-XPG-P-5XX

0A	AM	03/22/22	CUSTOMER DRAWING
REV.	INIT.	DATE	DESCRIPTION
			ORIG. DRAWN BY: AM DATE: 03/22/22
ALL INFORMATION ILLUSTRATED IS THE PROPERTY OF CONXALL CORPORATION. UNAUTHORIZED DUPLICATION OR DISTRIBUTION OF THIS DOCUMENT IS PROHIBITED.			<p>601 E. WILDWOOD VILLA PARK, IL 60181</p>
ALL UNITS ARE IN FEET, INCHES, FRACTION OF INCHES AND DECIMALS. UNLESS OTHERWISE SPECIFIED TOLERANCES: 3 PLACE DECIMALS ±.005 ANGLES ±1° FRACTIONS ±1/16			
APPROVED BY:		SCALE: NTS	TITLE: IN LINE CABLE CONNECTOR (2-4) #12, (4-6) #16, (4-12) #20 PIN CONTACTS MULTI CONX INSTA-CLICK STANDARD PRODUCT
FILE:	DIRECTORY:	SHEET: 1 OF 1	CUSTOMER: W5X8X-XPG-P-5XX
FILE NAME:	SLW	PART NUMBER:	REV 0A