

### Features

- 0.28 inch (7.0mm) digit height
- Continuous uniform segments.
- Low power requirement.
- Excellent characters appearance.
- Solid state reliability.
- Wide viewing angle.
- Categorized for luminous intensity.
- I.C. compatible.
- Easy mounting on P.C. board or socket.

### Description

The LTS-2X01AB, LTD-2000B, LTC-2000B series are 0.28 inch (7.0mm) height seven segment single, dual, triple and quadruple digit displays.

The blue series devices utilize LED chips which are made from GaN on a SiC substrate. The devices have gray face and white segments.

### Package Dimensions

A. LTS-2301AB/2801AB

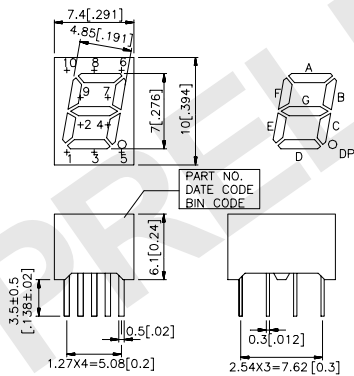

B. LTD-2601B/2701B

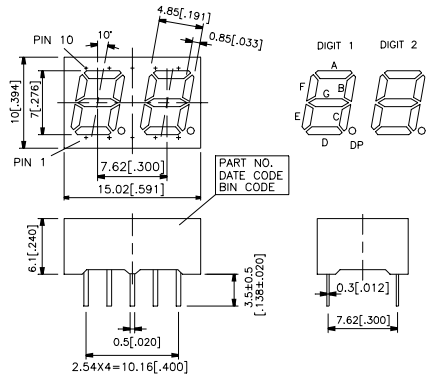

C. LTC-2621B/2721B

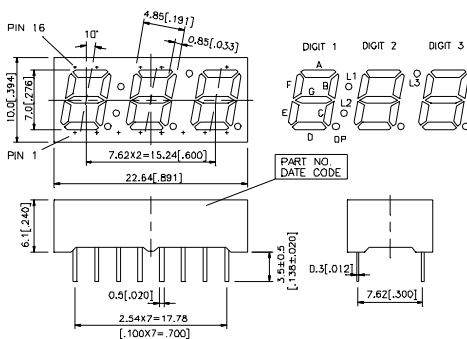

D. LTC-2623B/2723B

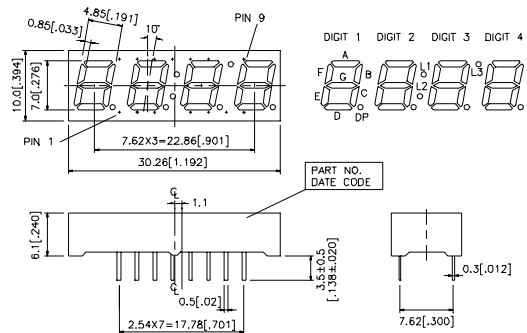

Notes: All dimensions are in millimeters (inches). Tolerance:  $\pm 0.25\text{mm}$  ( $\pm 0.01''$ ) unless otherwise noted.

## Devices

Part No.	Description	Package Dimension	Internal Circuit Diagram
blue			
LTS-2301AB	Common Cathode, Rt. Hand Decimal	A	A
LTS-2801AB	Common Anode, Rt. Hand Decimal	A	B
LTD-2601B	Dualplex Common Anode, Rt. Hand Decimal	B	C
LTD-2701B	Dualplex Common Cathode, Rt. Hand Decimal	B	D
LTC-2621B	Multiplex Common Anode, Rt. Hand Decimal	C	E
LTC-2721B	Multiplex Common Cathode, Rt. Hand Decimal	C	F
LTC-2623B	Multiplex Common Anode, Rt. Hand Decimal	D	G
LTC-2723B	Common Common Cathode, Rt. Hand Decimal	D	H

## Pin Connection

Pin No.	Connection	
	A.LTS-2301AB	B.LTS-2801AB
1.	Anode E	Cathode E
2.	Anode D	Cathode D
3.	Common Cathode	Common Anode
4.	Anode C	Cathode C
5.	Anode D.P.	Cathode D.P.
6.	Anode B	Cathode B
7.	Anode A	Cathode A
8.	Common Cathode	Common Anode
9.	Anode G	Cathode G
10.	Anode F	Cathode F

Pin No.	Connection	
	C.LTD-2601B	D.LTD-2701B
1.	Cathode E	Anode E
2.	Cathode D	Anode D
3.	Cathode C	Anode C
4.	Cathode G	Anode G
5.	Cathode D.P.	Anode D.P.
6.	Common Anode Digit 2	Common Cathode Digit 2
7.	Cathode A	Anode A
8.	Cathode B	Anode B
9.	Common Anode Digit 1	Common Cathode Digit 1
10.	Cathode F	Anode F

Pin No.	Connection	
	E.LTC-2621B	F.LTC-2721B
1.	Cathode D	Anode D
2.	Common Anode Digit 1	Common Cathode Digit 1
3.	Cathode D.P.	Anode D.P.
4.	Cathode E	Anode E
5.	Common Anode Digit 2	Common Cathode Digit 2
6.	Cathode C	Anode C
7.	Cathode G	Anode G
8.	Common Anode Digit 3	Common Cathode Digit 3
9.	No Connection	No Connection
10.	No Pin	No Pin
11.	No Pin	No Pin
12.	Cathode B	Anode B
13.	Common Anode L1, L2, L3	Common Cathode L1, L2, L3
14.	No Pin	No Pin
15.	Cathode A	Anode A
16.	Cathode F	Anode F

Pin No.	Connection	
	G.LTC-2623B	H.LTC-2723B
1.	Common Anode Digit 1	Common Cathode Digit 1
2.	Cathode C, L3	Anode C, L3
3.	Cathode D.P.	Anode D.P.
4.	No Connection	No Connection
5.	Cathode E	Anode E
6.	Cathode D	Anode D
7.	Cathode G	Anode G
8.	Common Anode Digit 4	Common Cathode Digit 4
9.	No Connection	No Connection
10.	No Pin	No Pin
11.	Common Anode Digit 3	Common Cathode Digit 3
12.	Common Anode L1, L2, L3	Common Cathode L1, L2, L3
13.	Cathode A, L1	Anode A, L1
14.	Common Anode Digit 2	Common Cathode Digit 2
15.	Cathode B, L2	Anode B, L2
16.	Cathode F	Anode F

### Internal Circuit Diagrams

A.LTS-2301AB

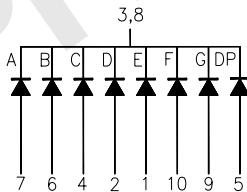

B.LTS-2801AB

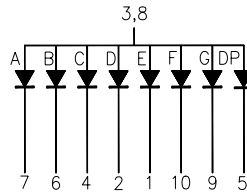

C.LTD-2601B

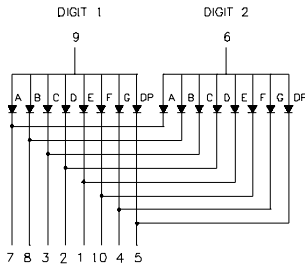

D.LTD-2701B

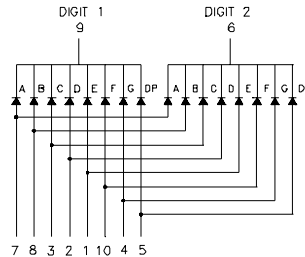

### E.LTC-2621B

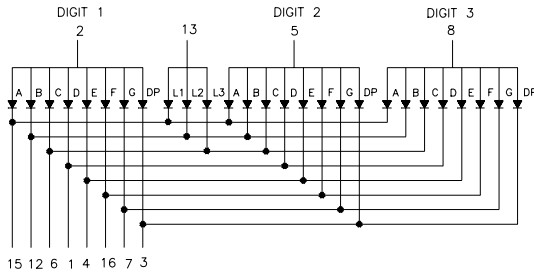

### F.LTC-2721B

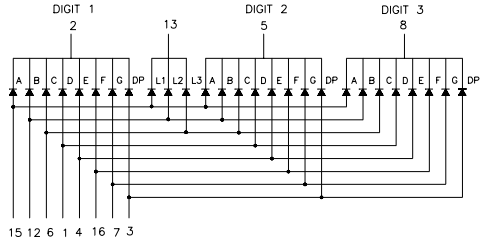

### G.LTC-2623B

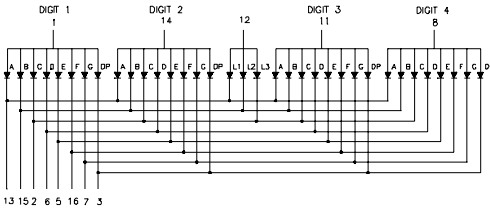

### H.LTC-2723B

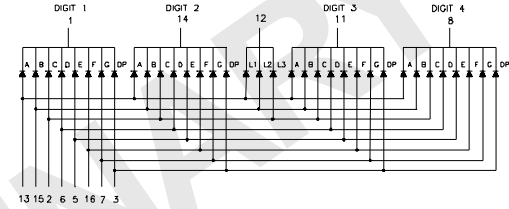

## Absolute Maximum Rating at Ta=25°C

Parameter	Blue	Unit
Power Dissipation Per Segment	65	mW
Peak Forward Current Per Segment (1/10 Duty Cycle, 0.1ms Pulse Width)	60	mA
Continuous Forward Current Per Segment Derating Linear from 25°C Per Segment	15 0.2	mA mA/°C
Reverse Voltage Per Segment	5	V
Operating Temperature Range	-35°C to +85°C	
Storage Temperature Range	-35°C to +85°C	
Solder Temperature 1/16 Inch Below Seating Plane for 3 Seconds at 260°C		

## Electrical/Optical Characteristics at Ta=25°C

Parameter	Symbol	Min.	Typ.	Max.	Unit	Test Condition
Average Luminous Intensity	I <sub>v</sub>	1000	3000		μ cd	I <sub>F</sub> =10mA
Peak Emission Wavelength	λ <sub>P</sub>		428		nm	I <sub>F</sub> =20mA
Spectral Line Half-Width	Δλ		65		nm	I <sub>F</sub> =20mA
Dominant Wavelength	λ <sub>d</sub>		466		nm	I <sub>F</sub> =20mA
Forward Voltage, Per Segment	V <sub>F</sub>		3.8	4.5	V	I <sub>F</sub> =20mA
Reverse Current, Per Segment	I <sub>R</sub>			100	μ A	V <sub>R</sub> =5V
Luminous Intensity Matching Ratio	I <sub>v</sub> -m			2:1		I <sub>F</sub> =10mA

Notes: Luminous intensity is measured with a light sensor and filter combination that approximates the CIE (Commission Internationale de l'Eclairage) eye-response curve.

# Typical Electrical/Optical Characteristic Curves (25°C Ambient Temperature Unless Otherwise Noted)

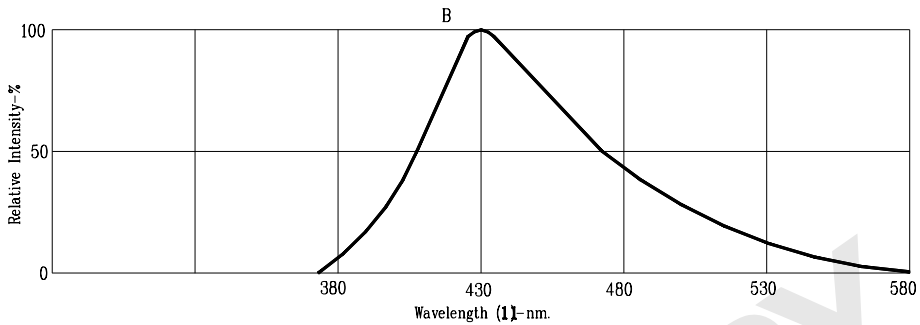

Fig1. RELATIVE INTENSITY VS. WAVELENGTH

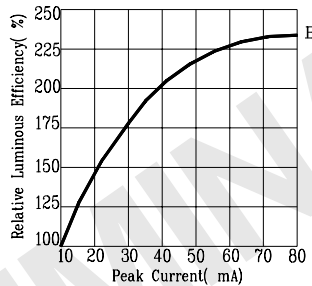

Fig2. RELATIVE LUMINOUS EFFICIENCY VS. PEAK FORWARD CURRENT (125us pulse width; 1ms period)

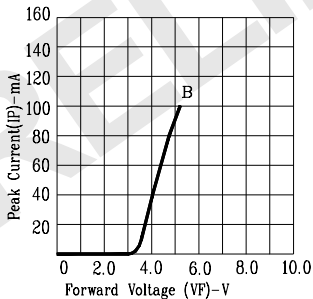

Fig3. FORWARD CURRENT VS. FORWARD VOLTAGE

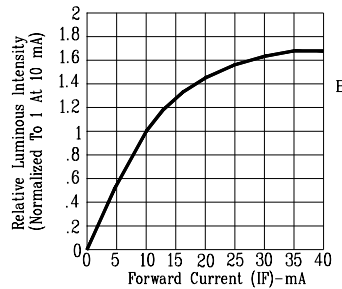

Fig4. RELATIVE LUMINOUS INTENSITY VS. FORWARD CURRENT

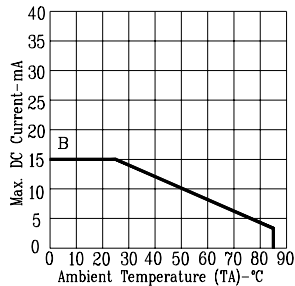

Fig5. MAX. ALLOWABLE DC CURRENT VS. AMBIENT TEMPERATURE.

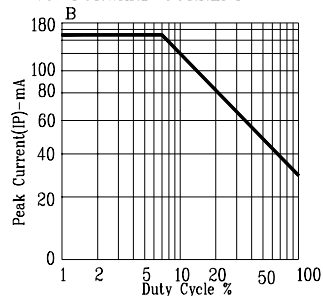

Fig6. MAX. PEAK CURRENT VS. DUTY CYCLE % (REFRESH RATE 1KHz)

NOTE: B= BLUE (REFRESH RATE 1KHz)