

HybridPACK™ Drive module with CoolSiC™ Automotive MOSFET

Features

- Electrical features
 - $V_{DS} = 1200\text{ V}$
 - $I_{D,nom} = 400\text{ A}$
 - New semiconductor material - silicon carbide
 - Low $R_{DS,on}$
 - Low switching losses
 - Low Q_g and C_{rSS}
 - Low inductive design $<10\text{ nH}$
 - $T_{vj,op} = 150^\circ\text{C}$
- Mechanical features
 - 4.2 kV DC 1 second insulation
 - High creepage and clearance distances
 - Compact design
 - High power density
 - Direct-cooled PinFin base plate
 - High-performance Si3N4 ceramic
 - Guiding elements for PCB and cooler assembly
 - Integrated NTC temperature sensor
 - PressFIT contact technology
 - RoHS compliant
 - UL 94 V0 module frame

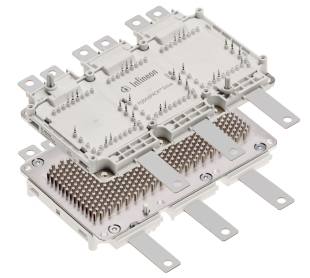

Potential applications

- Automotive applications
- (Hybrid) electrical vehicles (H)EV
- Motor drives
- Commercial agriculture vehicles

Product validation

- Qualified according to AQC 324, release no.: 03.1/2021

Description

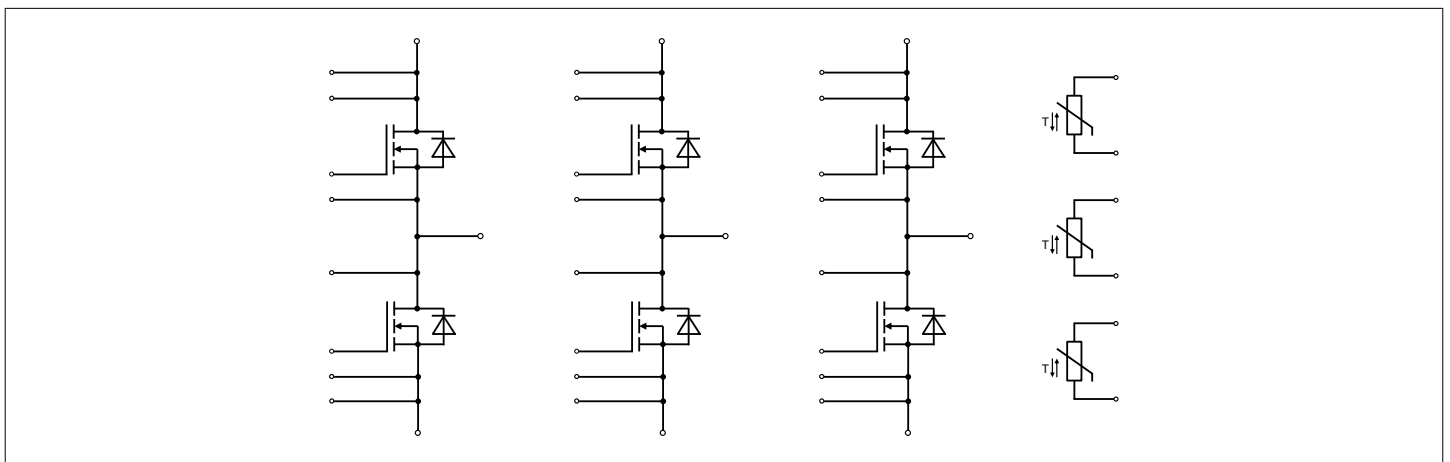

Table of contents

	Description	1
	Features	1
	Potential applications	1
	Product validation	1
	Table of contents	2
1	Package	3
2	MOSFET	4
3	Body diode	5
4	NTC-Thermistor	6
5	Characteristics diagrams	7
6	Circuit diagram	12
7	Package outlines	13
8	Module label code	14
	Revision history	15
	Disclaimer	16

1 Package

Table 1 Insulation coordination

Parameter	Symbol	Note or test condition	Values	Unit
Isolation test voltage	V_{ISOL}	RMS, $f = 0$ Hz, $t = 1$ sec	4.20	kV
Material of module baseplate			Ni+Cu ¹⁾	
Internal isolation		basic insulation (class 1, IEC 61140)	Si3N4	
Creepage distance	d_{creep}	terminal to heatsink	9.0	mm
Creepage distance	d_{creep}	terminal to terminal	9.0	mm
Clearance	d_{clear}	terminal to heatsink	4.5	mm
Clearance	d_{clear}	terminal to terminal	4.5	mm
Comparative tracking index	CTI		> 200	

1) Ni plated Cu baseplate

Table 2 Maximum rated values

Parameter	Symbol	Note or test condition	Values	Unit
Maximum RMS module terminal current	$I_{t,rms}$	$T_{terminal} = 105$ °C, $T_f = 75$ °C	500	A

Table 3 Characteristic values

Parameter	Symbol	Note or test condition	Values			Unit
			Min.	Typ.	Max.	
Pressure drop in cooling circuit	Δp	$\Delta V/\Delta t = 10$ dm ³ /min, 50% water / 50% ethylenglycol, $T_f = 60$ °C		64 ¹⁾		mbar
Maximum pressure in cooling circuit	p	$T_{baseplate} < 40$ °C (relative pressure)			2.5	bar
		$T_{baseplate} \geq 40$ °C (relative pressure)			2.0	
Stray inductance module	$L_{s,DS}$			8.5		nH
Module lead resistance, terminals - chip	$R_{DD'+SS'}$	$T_f = 25$ °C, per switch		0.75		mΩ
Storage temperature	T_{stg}		-40		125	°C
Mounting torque for module mounting	M	Screw M4 baseplate to heatsink	1.8	2.0	2.2	Nm
Weight	G			729		g

1) Cooler design and flow direction according to application note AN-HPDPERF-ASSEMBLY

2 MOSFET

Table 4 Maximum rated values

Parameter	Symbol	Note or test condition	Values	Unit
Drain-source voltage	V_{DSS}		$T_{vj} = 25\text{ °C}$	1200 V
DC drain current	$I_{D,nom}$	$V_{GS} = 15\text{ V}, T_f = 60\text{ °C}$	$T_{vj,max} = 175\text{ °C}$	400 A
Pulsed drain current	$I_{D,pulse}$	verified by design, t_p limited by $T_{vj,max}$		800 A
Gate-source voltage	V_{GSS}			-10/20 V

Table 5 Characteristic values

Parameter	Symbol	Note or test condition	Values			Unit	
			Min.	Typ.	Max.		
Drain-source on-resistance	$R_{DS,on}$	$I_D = 400\text{ A}, V_{GS} = 15\text{ V}$	$T_{vj} = 25\text{ °C}$	2.75	3.70	mΩ	
			$T_{vj} = 125\text{ °C}$	4.00			
			$T_{vj} = 150\text{ °C}$	4.55			
Gate threshold voltage	$V_{GS,th}$	$I_D = 240\text{ mA}, V_{GS} = V_{DS}$, (tested after 1ms pulse at $V_{GS} = +20\text{ V}$)	$T_{vj} = 25\text{ °C}$	3.25	4.40	5.55	V
Total gate charge	Q_G	$V_{DS} = 600\text{ V}, V_{GS} = -5/15\text{ V}$		1.32			μC
Internal gate resistor	$R_{G,int}$		$T_{vj} = 25\text{ °C}$	0.23			Ω
Input capacitance	C_{iss}	$f = 1\text{ MHz}, V_{DS} = 600\text{ V}, V_{GS} = 0\text{ V}$	$T_{vj} = 25\text{ °C}$	42.6			nF
Output capacitance	C_{oss}	$f = 1\text{ MHz}, V_{DS} = 600\text{ V}, V_{GS} = 0\text{ V}$	$T_{vj} = 25\text{ °C}$	1.86			nF
Reverse transfer capacitance	C_{rss}	$f = 1\text{ MHz}, V_{DS} = 600\text{ V}, V_{GS} = 0\text{ V}$	$T_{vj} = 25\text{ °C}$	0.17			nF
C_{oss} stored energy	E_{oss}	$V_{DS} = 600\text{ V}, V_{GS} = -5/15\text{ V}$	$T_{vj} = 25\text{ °C}$	438			μJ
Drain-source leakage current	I_{DSX}	$V_{GS} = -5\text{ V}, V_{DSS} = 1200\text{ V}$	$T_{vj} = 25\text{ °C}$			100	μA
Gate-source leakage current	I_{GSS}	$V_{GS} = 20\text{ V}, V_{DS} = 0\text{ V}$	$T_{vj} = 25\text{ °C}$			400	nA
Turn-on delay time, inductive load	$t_{d,on}$	$I_D = 400\text{ A}, R_{G,on} = 5.1\text{ Ω}, V_{GS} = -5/15\text{ V}, V_{DS} = 600\text{ V}$	$T_{vj} = 25\text{ °C}$	77			ns
			$T_{vj} = 125\text{ °C}$	62			
			$T_{vj} = 150\text{ °C}$	59			
Rise time (inductive load)	t_r	$I_D = 400\text{ A}, R_{G,on} = 5.1\text{ Ω}, V_{GS} = -5/15\text{ V}, V_{DS} = 600\text{ V}$	$T_{vj} = 25\text{ °C}$	79			ns
			$T_{vj} = 125\text{ °C}$	70			
			$T_{vj} = 150\text{ °C}$	69			

(table continues...)

Table 5 (continued) **Characteristic values**

Parameter	Symbol	Note or test condition	Values			Unit
			Min.	Typ.	Max.	
Turn-off delay time, inductive load	$t_{d,off}$	$I_D = 400\text{ A}, R_{G,off} = 5.1\ \Omega, V_{GS} = -5/15\text{ V}, V_{DS} = 600\text{ V}$	$T_{vj} = 25\text{ }^\circ\text{C}$	263		ns
			$T_{vj} = 125\text{ }^\circ\text{C}$	287		
			$T_{vj} = 150\text{ }^\circ\text{C}$	294		
Fall time (inductive load)	t_f	$I_D = 400\text{ A}, R_{G,off} = 5.1\ \Omega, V_{GS} = -5/15\text{ V}, V_{DS} = 600\text{ V}$	$T_{vj} = 25\text{ }^\circ\text{C}$	64		ns
			$T_{vj} = 125\text{ }^\circ\text{C}$	64		
			$T_{vj} = 150\text{ }^\circ\text{C}$	65		
Turn-on energy loss per pulse	E_{on}	$I_D = 400\text{ A}, R_{G,on} = 5.1\ \Omega, V_{GS} = -5/15\text{ V}, V_{DS} = 600\text{ V}, L_\sigma = 20\text{ nH}$	$T_{vj} = 25\text{ }^\circ\text{C}, di/dt = 4\text{ kA}/\mu\text{s}$	19.48		mJ
			$T_{vj} = 125\text{ }^\circ\text{C}, di/dt = 4.6\text{ kA}/\mu\text{s}$	19.85		
			$T_{vj} = 150\text{ }^\circ\text{C}, di/dt = 4.6\text{ kA}/\mu\text{s}$	20.16		
Turn-off energy loss per pulse	E_{off}	$I_D = 400\text{ A}, R_{G,off} = 5.1\ \Omega, V_{GS} = -5/15\text{ V}, V_{DS} = 600\text{ V}, L_\sigma = 20\text{ nH}$	$T_{vj} = 25\text{ }^\circ\text{C}, du/dt = 7.3\text{ kV}/\mu\text{s}$	17.61		mJ
			$T_{vj} = 125\text{ }^\circ\text{C}, du/dt = 7.2\text{ kV}/\mu\text{s}$	17.95		
			$T_{vj} = 150\text{ }^\circ\text{C}, du/dt = 7.1\text{ kV}/\mu\text{s}$	18.21		
Short circuit data	I_{SC}	$V_{DD} = 800\text{ V}, V_{GS} = -5/15\text{ V}, R_{G,on} = 5.1\ \Omega, R_{G,off} = 5.1\ \Omega, V_{DSmax} = V_{DSS} - L_{sDS} \cdot di/dt$	$t_{SC} = 3\ \mu\text{s}, T_{vj} = 25\text{ }^\circ\text{C}$	5300		A
			$t_{SC} = 3\ \mu\text{s}, T_{vj} = 150\text{ }^\circ\text{C}$	4800		
Thermal resistance, junction to cooling fluid	$R_{th,j-f}$	per MOSFET, $T_f = 60\text{ }^\circ\text{C}, \Delta V/\Delta t = 10\text{ dm}^3/\text{min}, 50\%\text{ water} / 50\%\text{ ethylenglycol}$		0.1	0.108 ¹⁾	K/W
Temperature under switching conditions	$T_{vj,op}$		-40		150	$^\circ\text{C}$

1) EoL criteria see AQG324, verified by characterization with 4.5 sigma. Cooler design and flow direction according to application note AN-HPDPERF-ASSEMBLY

3 Body diode

Table 6 **Maximum rated values**

Parameter	Symbol	Note or test condition	Values	Unit
DC body diode forward current	$I_{F,S}$	$T_{vj,max} = 175\text{ }^\circ\text{C}, T_f = 60\text{ }^\circ\text{C}, V_{GS} = -5\text{ V}$	210	A
Pulsed body diode current	$I_{F,S,pulse}$	verified by design, t_p limited by $T_{vj,max}$	800	A

Table 7 Characteristic values

Parameter	Symbol	Note or test condition	Values			Unit	
			Min.	Typ.	Max.		
Forward voltage	$V_{F,SD}$	$I_{F,S} = 400 \text{ A}, V_{GS} = -5 \text{ V}$	$T_{vj} = 25 \text{ °C}$		4.42	6.15	V
			$T_{vj} = 125 \text{ °C}$		4.22		
			$T_{vj} = 150 \text{ °C}$		4.16		
Peak reverse recovery current	I_{rrm}	$I_{F,S} = 400 \text{ A}, V_{GS} = -5 \text{ V}, V_{R,DS} = 600 \text{ V}$	$T_{vj} = 25 \text{ °C}$		165		A
			$T_{vj} = 125 \text{ °C}$		287		
			$T_{vj} = 150 \text{ °C}$		309		
Recovered charge	Q_{rr}	$I_{F,S} = 400 \text{ A}, V_{GS} = -5 \text{ V}, V_{R,DS} = 600 \text{ V}$	$T_{vj} = 25 \text{ °C}$		11.20		μC
			$T_{vj} = 125 \text{ °C}$		18.10		
			$T_{vj} = 150 \text{ °C}$		19.30		
Reverse recovery energy	E_{rec}	$I_{F,S} = 400 \text{ A}, V_{GS} = -5 \text{ V}, V_{R,DS} = 600 \text{ V}$	$T_{vj} = 25 \text{ °C}, -di/dt = 5.9 \text{ kA}/\mu\text{s}$		1.4		mJ
			$T_{vj} = 125 \text{ °C}, -di/dt = 6.9 \text{ kA}/\mu\text{s}$		4.0		
			$T_{vj} = 150 \text{ °C}, -di/dt = 6.9 \text{ kA}/\mu\text{s}$		4.7		

4 NTC-Thermistor

Table 8 Characteristic values

Parameter	Symbol	Note or test condition	Values			Unit
			Min.	Typ.	Max.	
Rated resistance	R_{25}	$T_{NTC} = 25 \text{ °C}$		5		k Ω
Deviation of R_{100}	$\Delta R/R$	$T_{NTC} = 100 \text{ °C}, R_{100} = 493 \text{ }\Omega$	-5		5	%
Power dissipation	P_{25}	$T_{NTC} = 25 \text{ °C}$			20	mW
B-value	$B_{25/50}$	$R_2 = R_{25} \exp[B_{25/50}(1/T_2 - 1/(298,15 \text{ K}))]$		3375		K
B-value	$B_{25/80}$	$R_2 = R_{25} \exp[B_{25/80}(1/T_2 - 1/(298,15 \text{ K}))]$		3411		K
B-value	$B_{25/100}$	$R_2 = R_{25} \exp[B_{25/100}(1/T_2 - 1/(298,15 \text{ K}))]$		3433		K

5 Characteristics diagrams

Pressure drop in cooling circuit, Package

$$\Delta p = f(\Delta V/\Delta t)$$

$T_f = 60\text{ }^\circ\text{C}$, fluid = 50% water/50% ethylenglycol

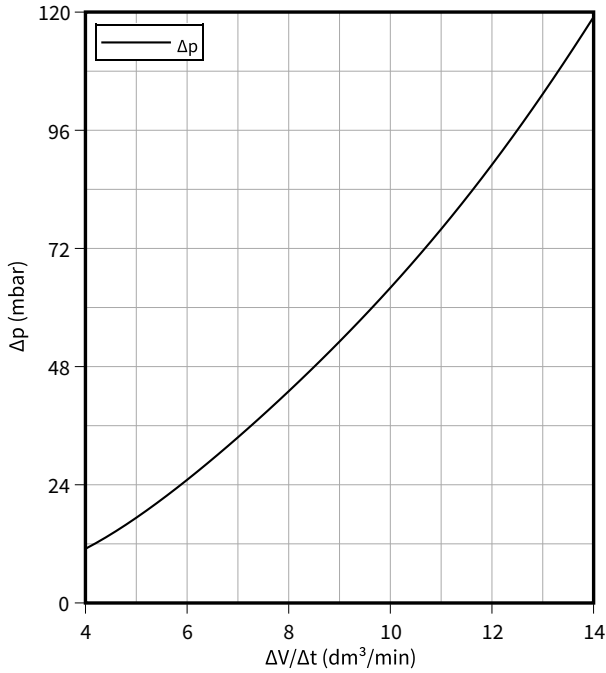

Output characteristic (typical), MOSFET

$$I_D = f(V_{DS})$$

$V_{GS} = 15\text{ V}$

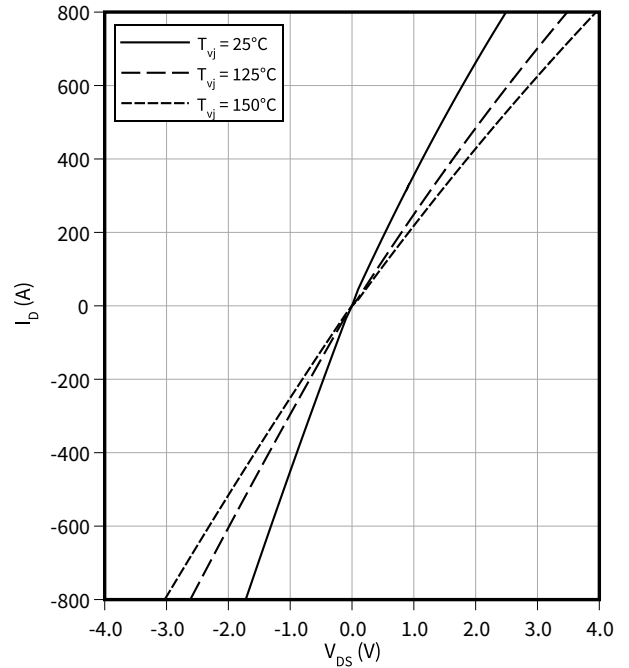

Output characteristic (typical), MOSFET

$$I_D = f(V_{DS})$$

$T_{vj} = 125\text{ }^\circ\text{C}$

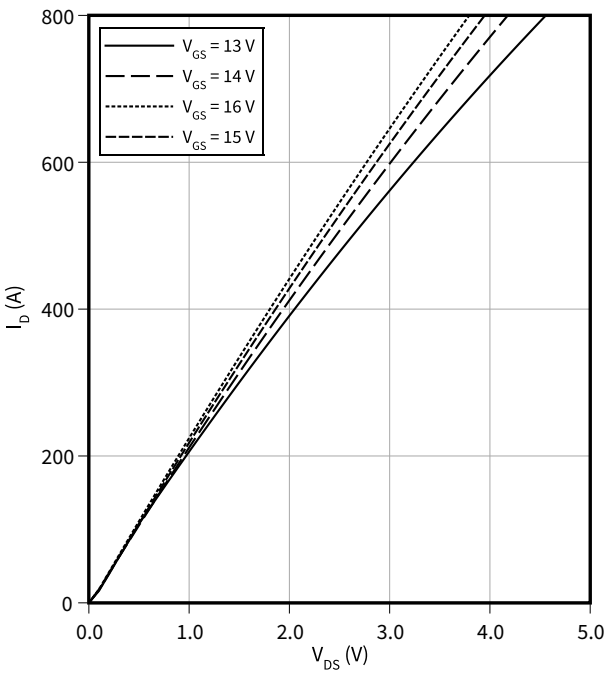

Transfer characteristic (typical), MOSFET

$$I_D = f(V_{GS})$$

$V_{DS} = 20\text{ V}$

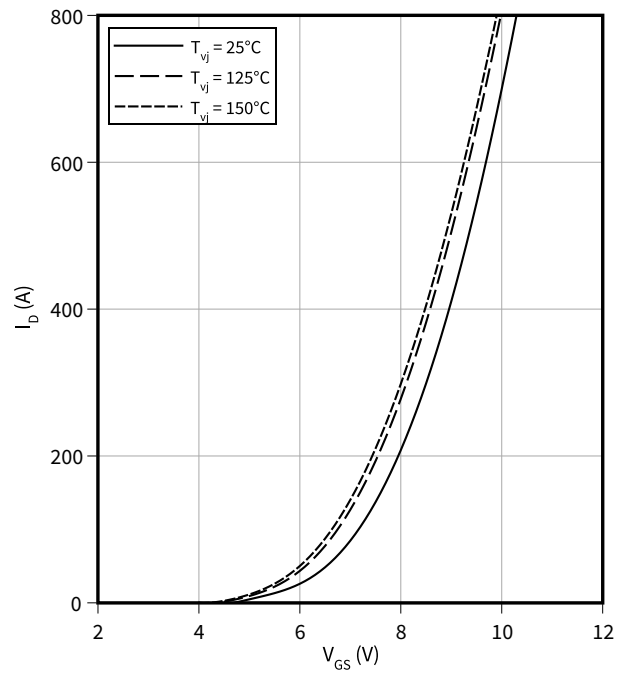

5 Characteristics diagrams

Drain-source on-resistance (typical), MOSFET

$R_{DS,on} = f(I_D)$
 $V_{GS} = 15\text{ V}$

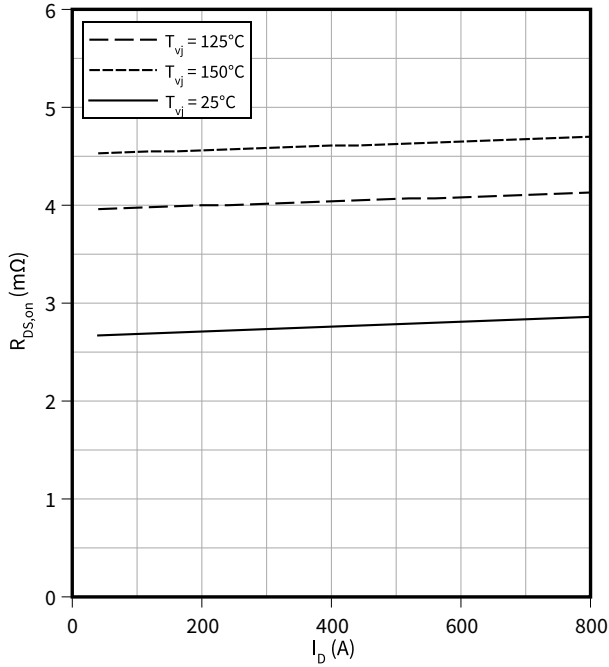

Drain-source on-resistance (typical), MOSFET

$R_{DS,on} = f(T_{vj})$
 $I_D = 400\text{ A}, V_{GS} = 15\text{ V}$

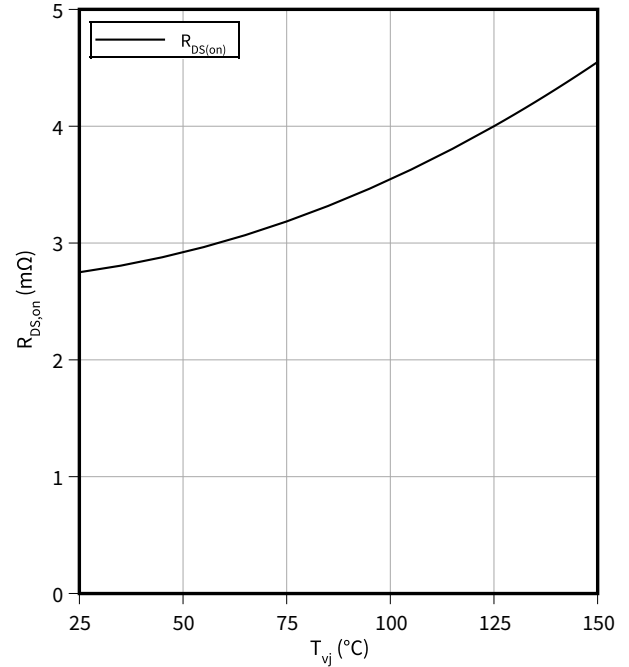

Maximum allowed drain-source voltage, MOSFET

$V_{DSS} = f(T_{vj})$

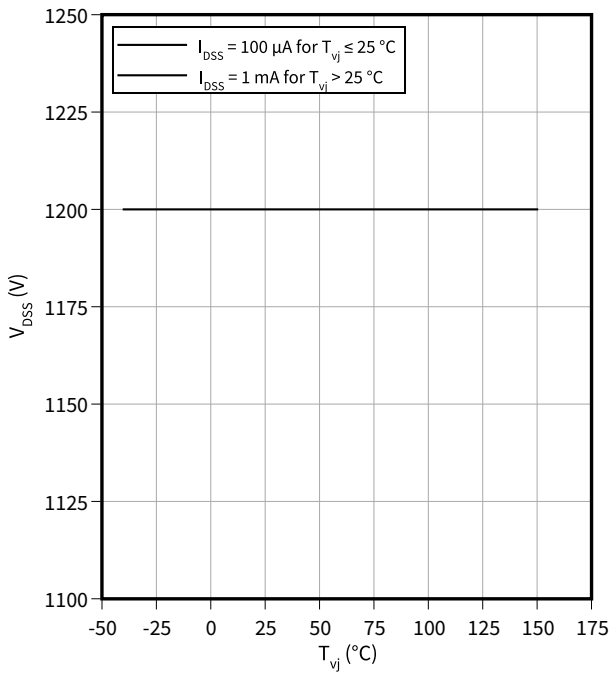

Capacity characteristic (typical), MOSFET

$C = f(V_{DS})$
 $T_{vj} = 25^\circ\text{C}, f = 1\text{ MHz}, V_{GS} = 0\text{ V}$

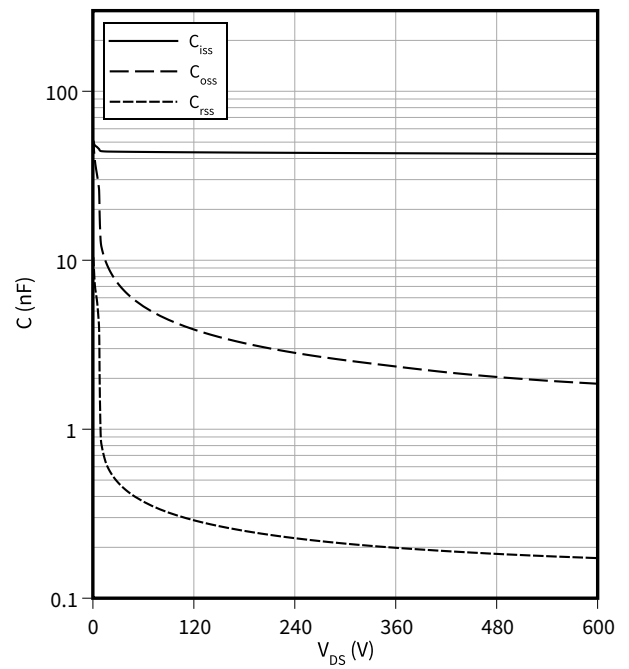

5 Characteristics diagrams

Switching losses (typical), MOSFET

$E = f(R_G)$

$I_D = 400 \text{ A}$, $V_{DS} = 600 \text{ V}$, $V_{GS} = -5/15 \text{ V}$

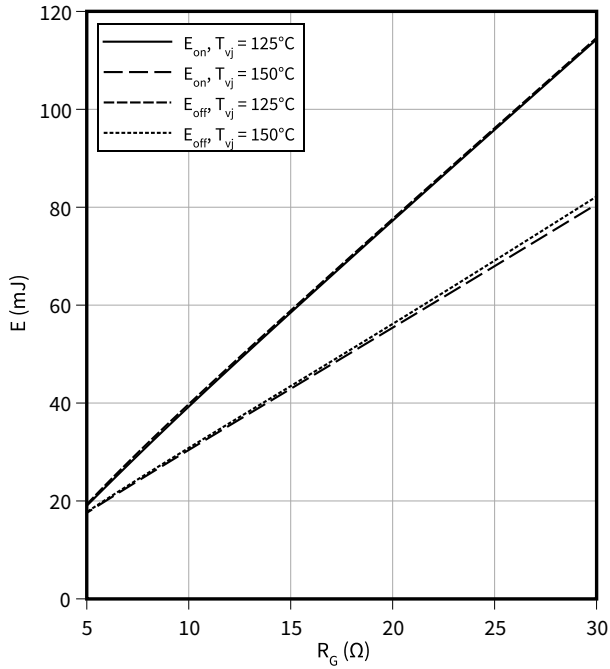

Switching losses (typical), MOSFET

$E = f(I_D)$

$V_{DS} = 600 \text{ V}$, $R_{G,off} = 5.1 \text{ } \Omega$, $R_{G,on} = 5.1 \text{ } \Omega$, $V_{GS} = -5/15 \text{ V}$

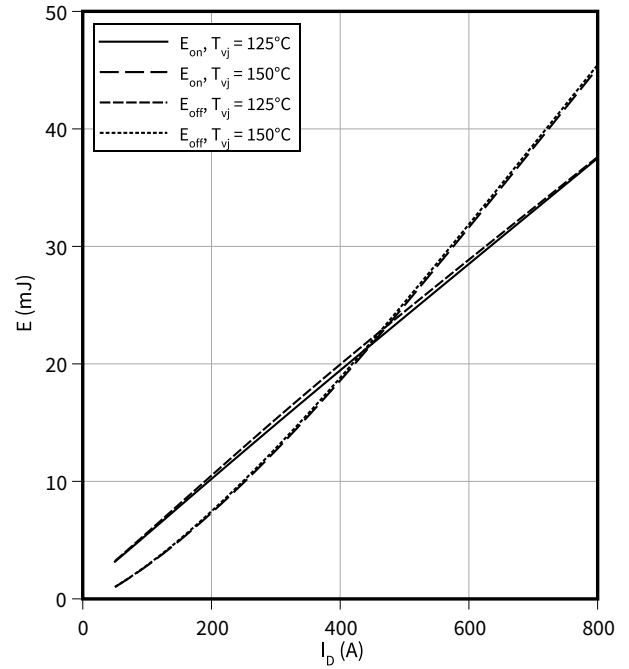

Reverse bias safe operating area (RBSOA), MOSFET

$I_D = f(V_{DS})$

$R_{G,off} = 5.1 \text{ } \Omega$, $V_{GS} = +15/-5 \text{ V}$, $T_{vj} = 150 \text{ } ^\circ\text{C}$

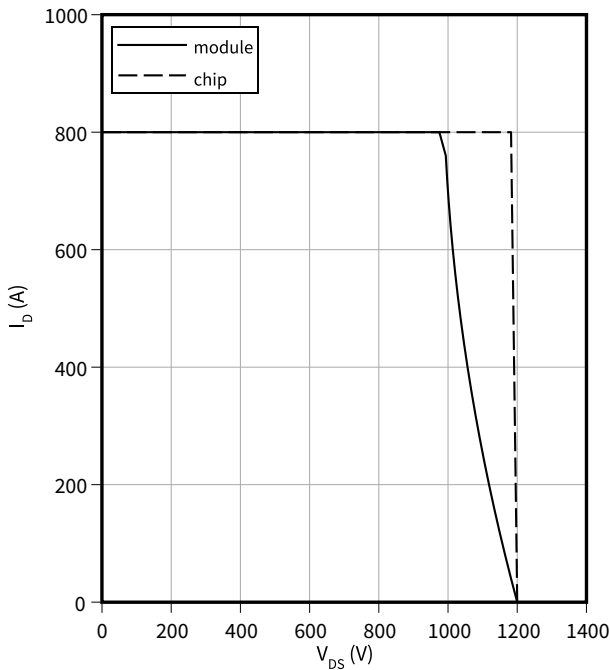

Thermal impedance , MOSFET

$R_{th,j-f} = f(dv/dt)$

fluid = 50% water/50% ethylenglycol , $T_f = 60 \text{ } ^\circ\text{C}$

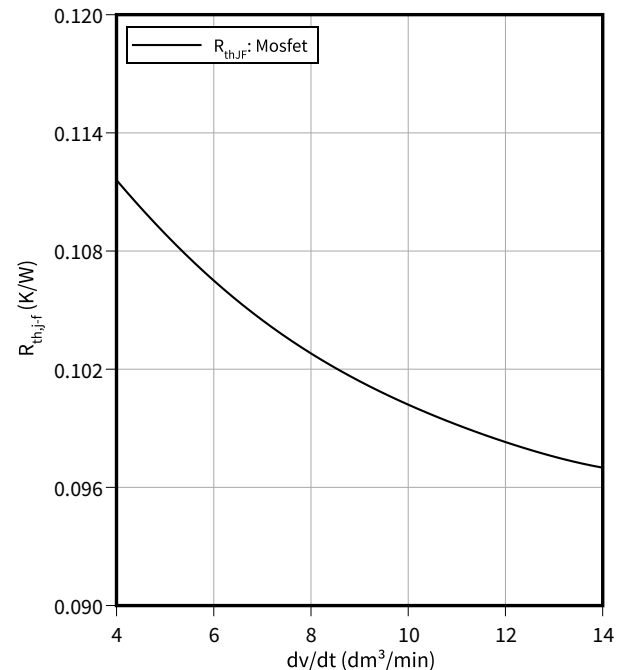

5 Characteristics diagrams

Transient thermal impedance, MOSFET

$Z_{th} = f(t)$

$\Delta V/\Delta t = 10 \text{ dm}^3/\text{min}$, fluid = 50% water/50% ethylenglycol, $T_f = 60 \text{ }^\circ\text{C}$

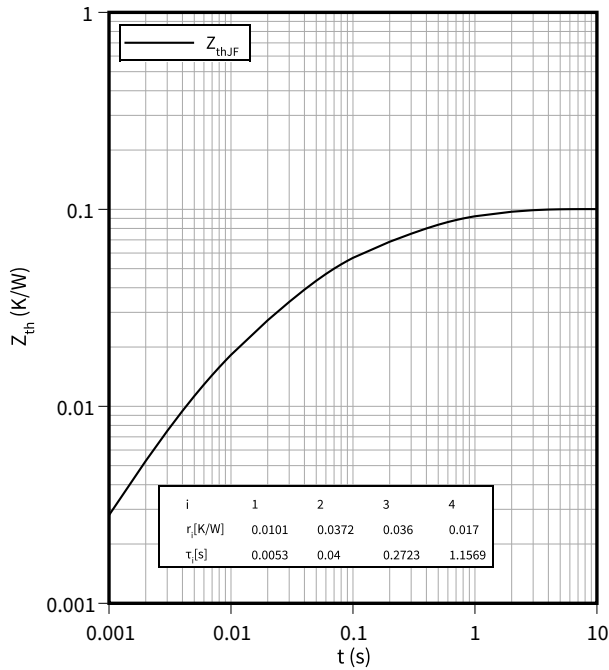

Forward characteristic body diode (typical), MOSFET

$I_{F,S} = f(V_{SD})$

$T_{vj} = 25 \text{ }^\circ\text{C}$

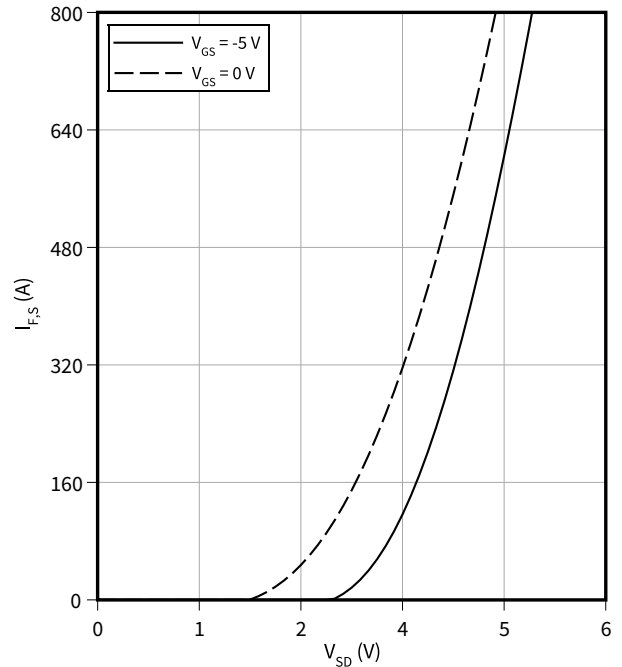

Switching losses body diode (typical), MOSFET

$E_{rec} = f(I_{SD})$

$V_r = 600 \text{ V}$, $R_{G,on} = 5.1 \text{ } \Omega$, $V_{GS} = -5/15 \text{ V}$

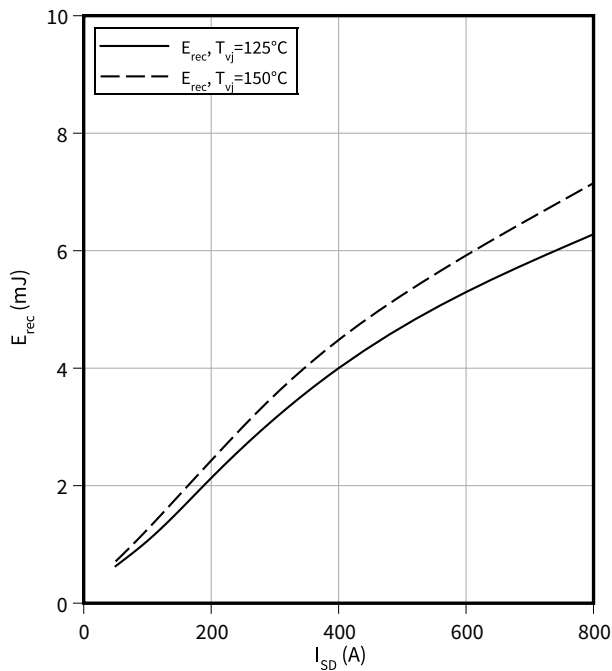

Switching losses body diode (typical), MOSFET

$E_{rec} = f(R_G)$

$V_r = 600 \text{ V}$, $I_{F,S} = 400 \text{ A}$, $V_{GS} = -5/15 \text{ V}$

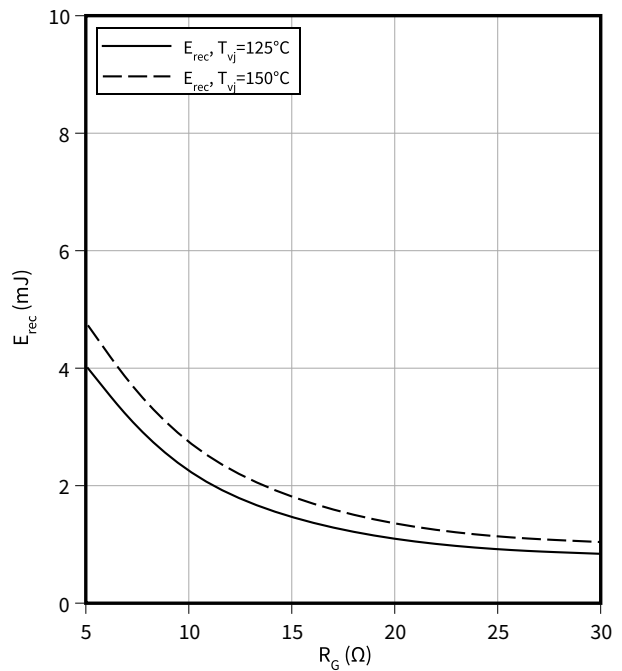

Temperature characteristic (typical), NTC-Thermistor

$$R = f(T_{NTC})$$

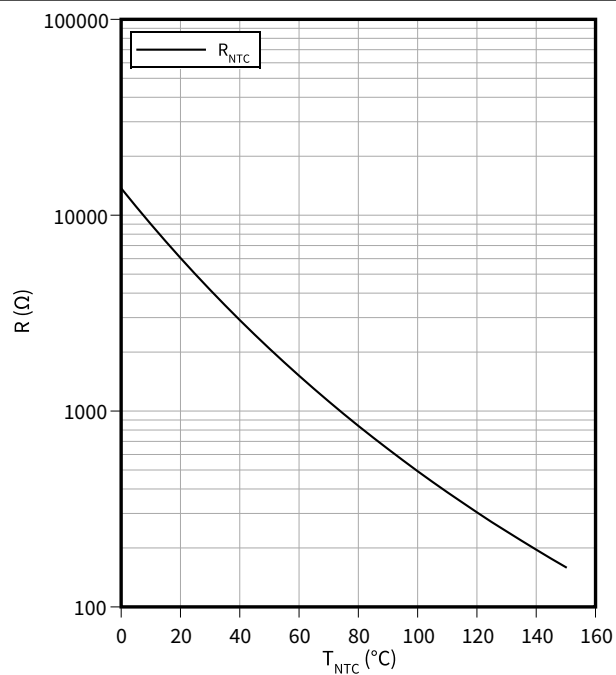

6 Circuit diagram

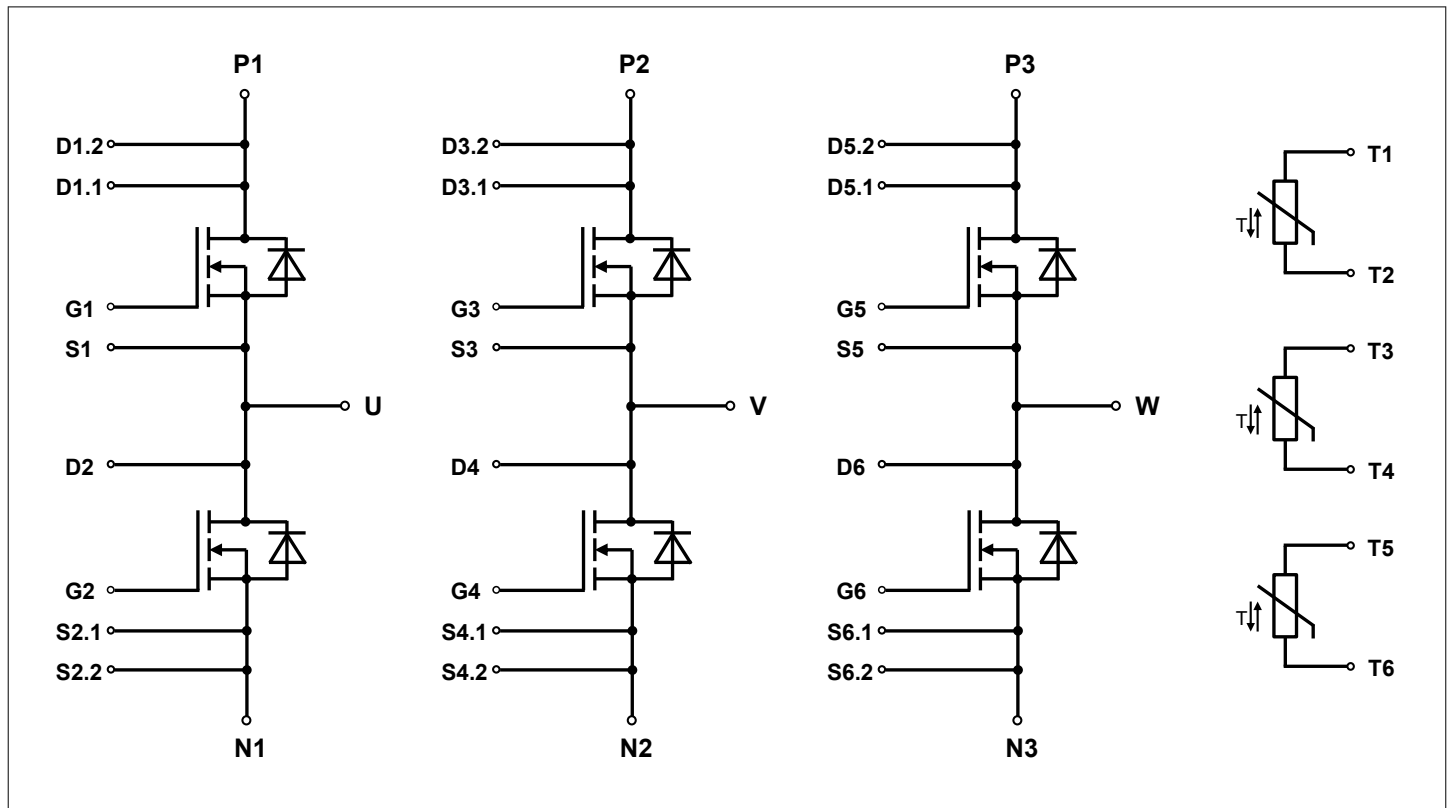

Figure 1

8 Module label code



Module label code				
Code format	Data Matrix	Barcode Code128		
Encoding	ASCII text	Code Set A		
Symbol size	16x16	23 digits		
Standard	IEC24720 and IEC16022	IEC8859-1		
Code content	<i>Content</i>	<i>Digit</i>	<i>Example</i>	
	Module serial number	1 - 5	71549	
	Module material number	6 - 11	142846	
	Production order number	12 - 19	55054991	
	Date code (production year)	20 - 21	15	
	Date code (production week)	22 - 23	30	
Example				
	71549142846550549911530		71549142846550549911530	
Packing label code				
Code format	Barcode Code128			
Encoding	Code Set A			
Symbol size	34 digits			
Standard	IEC8859-1			
Code content	<i>Content</i>	<i>Identifier</i>	<i>Digit</i>	<i>Example</i>
	Module serial number	X	2 - 9	95056609
	Module material number	1T	12 - 19	2X0003E0
	Production order number	S	21 - 25	754389
	Date code (production year)	9D	28 - 31	1139
	Date code (production week)	Q	33 - 34	15
Example				
	X950566091T2X0003E0S754389D1139Q15			

Figure 3

Revision history

Document revision	Date of release	Description of changes
V1.0	2019-09-03	Target datasheet
V2.0	2021-01-26	Preliminary datasheet
n/a	2020-10-05	Datasheet migrated to a new system with a new layout and new revision number schema: target or preliminary datasheet = 0.xy; final datasheet = 1.xy
1.00	2021-03-23	Final datasheet
1.10	2022-07-19	Adaption of product identification Adding electrical feature diagram Correction of typos

Trademarks

All referenced product or service names and trademarks are the property of their respective owners.

Edition 2022-07-19

Published by

Infineon Technologies AG

81726 Munich, Germany

© 2022 Infineon Technologies AG

All Rights Reserved.

Do you have a question about any aspect of this document?

Email: erratum@infineon.com

Document reference

IFX-AAD288-004

Important notice

The information given in this document shall in no event be regarded as a guarantee of conditions or characteristics ("Beschaffheitsgarantie").

With respect to any examples, hints or any typical values stated herein and/or any information regarding the application of the product, Infineon Technologies hereby disclaims any and all warranties and liabilities of any kind, including without limitation warranties of non-infringement of intellectual property rights of any third party.

In addition, any information given in this document is subject to customer's compliance with its obligations stated in this document and any applicable legal requirements, norms and standards concerning customer's products and any use of the product of Infineon Technologies in customer's applications.

The data contained in this document is exclusively intended for technically trained staff. It is the responsibility of customer's technical departments to evaluate the suitability of the product for the intended application and the completeness of the product information given in this document with respect to such application.

Warnings

Due to technical requirements products may contain dangerous substances. For information on the types in question please contact your nearest Infineon Technologies office.

Except as otherwise explicitly approved by Infineon Technologies in a written document signed by authorized representatives of Infineon Technologies, Infineon Technologies' products may not be used in any applications where a failure of the product or any consequences of the use thereof can reasonably be expected to result in personal injury.